



Il catalogo 31 vuol essere la rappresentazione, verso il mercato, di quanto è cresciuta la UFS. Moderni software, personalizzati sulle esigenze dell'azienda, ne coordinano la gestione operativa e finanziaria. La produzione viene assistita dall'ordine alla consegna ottimizzando i flussi e permettendo di creare spazi esecutivi per introdurre nuove tipologie di utensili specifici soddisfacendo, nella fascia più alta, la lavorazione di materiali impegnativi e di ultima generazione. Qualsiasi sia l'esigenza di filettatura si troverà risposta nelle tre linee di prodotto: **LINE**, **PLUS** e **TOP**.

Our Catalogue 31 is intended to reflect the growth of UFS in the market.

*New leading-edge software customized to the company's needs helps managing its operational and business development. Production assisted from order to delivery with production flow optimization allowing for space to deal with a range of new types of specific tools meeting the requirements from materials of the latest generation. Whatever the requirements for threading, the answer is in one of our three lines of products: **LINE**, **PLUS** and **TOP**.*

Le catalogue 31 est une représentation des dernières évolutions des services D'UFS.

*Des logiciels modernes, adaptés aux besoins de la société, ont été mis en place pour coordonner la gestion opérationnelle et financière. La production est assistée au départ de la commande jusqu'à la livraison en optimisant le flux tout en permettant de créer de l'espace pour introduire de nouveaux types d'outils spéciaux, haut de gamme, pour le traitement des matériaux de dernière génération. Chez UFS nous proposons trois gammes de produits afin de satisfaire toute les exigences du Taraudage: **LINE**, **PLUS** et **TOP**.*



La **UFS Technology** è dotata di apparecchiature di rilevazione sforzi, rilevazione attriti e di registrazione delle prove di filettatura consentendo il continuo monitoraggio del prodotto con una costante ricerca tesa al miglioramento. Su richiesta, è inoltre possibile lo studio ed il testing di nuovi utensili su materiali particolari eventualmente forniti dal cliente. Da qualche mese è operativo un reparto di rivestimento superficiale (TiN / TiCN / TiAlN / TXC) e un nuovo moderno reparto di tempra sottovuoto.

***UFS Technology** was set up many years ago to provide continuous product monitoring and research for quality improvement by means of special equipment for friction and stress measurement and threading test recording. Study and testing of new tools on special materials supplied by the customers can also be carried out on request. Since some months it is operating a department of superficial coating (TiN / TiCN / TiAlN / TXC) and a new modern department of vacuum tempering.*

***UFS Technology** est opérationnel avec un laboratoire équipé de matériel de détection, de friction et d'enregistrement d'efforts. Des essais de filetage permettent la surveillance continue du produit avec une constante recherche précise visant à améliorer le résultat final. Sur demande, nous pouvons étudier et tester de nouveaux outils sur des matériaux spécifiques fournis par le client. Depuis fin 2013, la société UFS a investi dans de nouveaux fours qui permettent d'être autonome et plus précis en ce qui concerne la trempe et les traitements de surface sous vide (TiN / TiCN / TiAlN / TXC).*

UFS - via Giotto, 20

10080 Sparone (TO) - Italy - Tel. 0039 0124 818001 - Fax 0039 0124 818003

www.ufs.it

TABELLA D'IMPIEGO

APPLICATION TABLE TABLE D'OPÉRATION

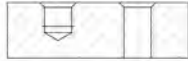

Applicazione per foro cieco e passante
Blind and through hole application
Application pour trou borgne et débouchant

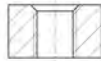

Applicazione per foro passante
Through hole application
Application pour trou débouchant



Applicazione per foro cieco
Blind hole application
Application pour trou borgne



- LH** Filettatura sinistra
Left hand thread - Filetage à gauche
- Ms58** Applicazione specifica per ottone Ms58
Specific application for brass Ms58 - Spécifique pour laiton Ms58
- AZ** Alternatura del filetto
Interrupted threads - Taraud avec filets alternés
- SR** Synchro Rigid, maschiatura rigida sincronizzata
Rigid tapping Synchro - Synchro Rigide, taraudage rigide synchronisée
- XL** Maschi con gambo lungo
Taps with long shank - Tarauds série longue
- BT** Back Tapered, rastremazione posteriore a botte del filetto
Back tapered thread - Détalonnage arrière
- IT** Inox Tapered, rastremazione posteriore orizzontale del filetto
*Horizontal back tapered for inox application
INOX Tapered, détalonné conique horizontale pour application Inox*
- con1:16** Maschi con filettatura conica
Taps with tapered thread - Tarauds à filetage conique
- Al** Applicazione specifica per alluminio e leghe d'alluminio
*Specific application for aluminium and aluminium alloys
Application spécifique pour l'aluminium et alliages d'aluminium*
- Cu** Applicazione specifica per rame e leghe rame
Specific application for copper and copper alloys - Application spécifique pour le cuivre et ses alliages
- Ti** Applicazione specifica per titanio e leghe di titanio
Specific application for titanium and titanium alloys - Application spécifique pour titane et alliages de titane
- Ni** Applicazione specifica per nichel e leghe di nichel
Specific application for nickel and nickel alloys - Application spécifique pour le nickel et ses alliages

Indicazione numero di pagina
Page number
Numéro de page

- Utilizzo raccomandato - velocità di taglio m/min
- Recommended Use - cutting speed m/min
- Utilisation Recommandée - vitesse de coupe m/min
- Utilizzo accettabile - velocità di taglio m/min
- Acceptable Use - cutting speed m/min
- Utilisation acceptable - vitesse de coupe m/min

1. Acciaio <i>Steel Acier</i>	1.1 Acciaio dolce magnetico Magnetic soft steel Acier doux magnétique	1.2 Acciaio da costruzione, cementazione, automatico Structural, case carburizing and free cutting steel Acier de construction, trempé et automatique	1.3 Acciaio al carbonio Plain carbon steel Acier au carbone	1.4 Acciaio legato - Bonificato, fusioni d'acciaio Alloyed steel - Tempered steel, steel castings Acier allié, trempé et revenu, moulages d'acier	1.5 Acciaio legato - Bonificato Alloyed steel - Tempered steel Acier allié, trempé et revenu	1.6 Acciaio legato - Alta resistenza Alloyed steel - High strength steel Acier allié, haute résistance	1.7 Acciaio legato - Alta resistenza Alloyed steel - High strength steel Acier allié, haute résistance	1.8 Acciaio legato - Temprato Hardened steel Acier trempé	HB < 120	Rm N/mm ² < 400
									< 200	< 700
									< 250	< 850
									< 250	< 850
									250÷350	850÷1200
									38÷45 HRC	1200÷1400
									45÷49 HRC	1400÷1600
									49÷62 HRC	
2. Acciaio INOX <i>Stainless Steel Acier inoxydable</i>	2.1 Acciaio inox automatico Free machining stainless steel Acier inoxydable, automatique	2.2 Austenitico Austenitic Austénitique	2.3 Ferritico, Ferritico + Austenitico, Martensitico Ferritic, Ferritic + Austenitic, Martensitic Ferritique, austénitique + ferritiques, martensitiques	2.4 Leghe Cr-Ni resistenti alle alte temperature Cr-Ni alloys high temperatures resistant Alliage Cr-Ni résistant à des températures élevées					< 250	< 850
									< 250	< 850
									< 320	< 1100
									330÷410	1100÷1400
3. Ghisa <i>Cast iron Fonte</i>	3.1 Ghisa grigia lamellare Lamellar grey cast iron Fonte grise lamellaire	3.2 Ghisa grigia lamellare Lamellar grey cast iron Fonte grise lamellaire	3.3 Ghisa sferoidale Nodular cast iron Fonte ductile	3.4 Ghisa malleabile Malleable cast iron Fonte malleable	3.5 Ghisa vermicolare a grafite compatta Compacted cast iron with vermicular graphite Fonte vermiculaire à graphite compacté				< 180	< 600
									180÷300	600÷1000
									< 300	< 1000
									< 210	< 700
									200÷300	700÷1000
4. Alluminio, Magnesio <i>Al, Mg</i>	4.1 Alluminio / Magnesio non legato Aluminium / Magnesium unalloyed Alliage Al, Si <0.5% - Long chipping	4.2 Leghe di Al, Si < 0.5% - Truciolo lungo Al alloys, Si < 0.5% - Long chipping Alliage Al, Si <0.5% copeaux longs	4.3 Leghe di Al, Si < 10% - Truciolo medio Al alloys, Si < 10% - Medium chipping Alliage Al, Si <10% copeaux moyen	4.4 Leghe Al, Si > 10% - Truciolo corto Al alloys, Si > 10% - Short chipping Alliage Al, Si >10% copeaux courts	4.5 Leghe standard di magnesio Magnesium standard alloys Alliages de magnésium standards	4.6 Leghe di magnesio ad alta resistenza High strength magnesium alloys Alliages de magnésium de haute résistance			< 100	< 350
									< 150	< 500
									< 150	< 500
									< 180	< 600
										120÷300
									70÷120	240÷400
5. Rame <i>Copper Cuivre</i>	5.1 Rame puro, Rame elettrolitico - Truciolo lungo Copper unalloyed - Long chipping Cuivre pur, cuivre électrolytique, copeaux longs	5.2 Leghe di rame, α-ottone - Truciolo lungo Copper alloys, soft brass - Long chipping Alliages de cuivre, α-laiton copeaux longs	5.3 Leghe di rame, β-ottone, Bronzo - Truciolo corto Copper alloys, hard brass, bronze - Short chipping Alliages de cuivre, β-laiton, bronze copeaux courts	5.4 Bronzo ad alta resistenza High strength bronze Bronze haute résistance					< 100	< 350
									< 200	< 700
									< 200	< 700
									< 440	< 1500
6. Titanio <i>Titanium Titane</i>	6.1 Titanio non legato Titanium unalloyed Titane non allié	6.2 Leghe di titanio Titanium alloys Alliages de titane	6.3 Leghe di titanio Titanium alloys Alliages de titane						< 200	< 700
									< 270	< 900
									< 410	< 1400
7. Nichel <i>Nickel</i>	7.1 Nichel non legato Nickel unalloyed Nickel non allié	7.2 Leghe di Nichel Nickel alloys Alliages de nickel	7.3 Leghe di Nichel Nickel alloys Alliages de nickel						< 150	< 500
									< 270	< 900
									< 470	< 1600
8. Materie plastiche <i>Synthetic Material Matériaux Plastiques</i>	8.1 Materiali termoplastici - Truciolo extralungo Thermoplastics - Extra long chipping Matériaux thermoplastique coupeaux extra-longue	8.2 Materiali termoindurenti - Truciolo corto Thermosetting plastics - Short chipping Matériaux thermodurcissables coupeaux courts	8.3 Materie plastiche con fibre di rinforzo Reinforced plastic materials Plastiques avec fibres de renfort							< 80
										< 110
									240÷440	800÷1500
9. Materiali speciali <i>Special materials Matériaux spéciaux</i>	9.1 Materiali metallo - Ceramici (Cermets) TIC - Hard materials Matériaux métalliques, céramiques (Cermet)	9.2 Leghe a base cobalto Alloys on cobalt base Alliages à base de cobalt	9.3 Leghe di tungsteno Tungsten alloys Alliages de tungstène						< 51 HRC	< 1700
									< 350	< 1200
									< 52 HRC	< 1800
10. Grafite / Graphite	10.1 Grafite Graphite Graphite									< 100

Descrizione Description - Description	
Tipi di foro Hole Types - Type de trous	
CODICE - CODE - CODE	
Linea - Product line - Ligne	
Elica / NOTE Flute Type / Notes - Hélice / Notes	
M	ISO2/6H
MJ	ISO1/4H
	ISO3/6G
	7G 6H+0,1
MF	ISO2/6H
MJF	ISO1/4H
	ISO3/6G
	7G 6H+0,1
UNC	2B 3BX
UNF	2B 3BX
UNEF	2B
UNS	2B
8-12-16 UN	2B
20-28-32 UN	2B
G, (Rp)	
NPSM	
NPSF	
Rc	
NPT	
NPTF	
BSW	
PG, Tr, Rd	
EG-M	
Imbocco / Chamfer / Entrée	
Materiale / Steel tap / Matériel	
Rivestimenti / Coating / Revêtements	
Classe appl. / Appl. Class. / Classe d'appl.	
Prof. filett. / Thread depth / Prof. filetage	



CERTIFICATE OF REGISTRATION

This is to certify that:

UFS - UTENSILI FILETTATORI S.R.L.

Via Giotto, 20 | 10080 SPARONE (TO) Italy

is in compliance with the standard

UNI EN ISO 9001:2015

EA Code: 17

concerning the following kinds of products – processes – services:

Design, development, manufacturing and marketing of standard and special threading tools.

Progettazione, sviluppo, fabbricazione e commercializzazione di utensili standard e speciali per filettare.

Certificate No.: **SGQ 1177/B**

Issue Date: **01/06/2018**

Original Certification Date: **20/06/2006**

Current Certification Date: **01/06/2018**

Certificate Expiry Date: **18/06/2021**



ISO 9001
Quality



SGQ 026A SGA 054D SCR 015F

Membro degli Accordi di Mutuo
Riconoscimento EA, IAF e ILAC.

Signatory of EA, IAF and ILAC Mutual
Recognition Agreements



Kevin Goodwin
General Manager Technical Services
SAI Global Assurance

Certificato da:
SAI Global Italia, Corso Tazzoli 236/3, 10137 Torino, Italia
Questo certificato è soggetto alle Condizioni Contrattuali per la certificazione SAI Global Italia
Questo certificato è di proprietà di SAI Global Italia e deve essere restituito su richiesta a SAI Global Italia.
Per verificare la validità del presente certificato, riferirsi alla sezione "Assure Certificate" del sito: www.accredita.it
Questa valutazione è stata effettuata con la massima diligenza e competenza.
SAI Global si assume la responsabilità solo per comprovata negligenza.
SAI Global Italia fa parte del gruppo SAI Global Pty Ltd, 690 George St, Level 37-36, Sydney, NSW, 2000, Australia.



Le caratteristiche tecniche e le informazioni contenute in questo catalogo possono essere soggette a variazioni senza preavviso. I dati contenuti sono da considerarsi salvo errori o/e omissioni. La UFS in qualsiasi momento può a suo giudizio o senza preavviso apportare modifiche agli utensili inseriti a catalogo. La riproduzione dei dati e delle immagini contenute nel catalogo sono vietati salvo autorizzazione scritta da parte della UFS Srl.

The technical features and information in this catalogue are subject to change without notice. The information in the catalogue is to be considered accurate except for possible errors and/or omissions. UFS Srl reserves the right to make changes to the tools shown in this catalogue at any time and without notice. Reproduction of the information and pictures in this catalogue is not allowed without written authorisation from UFS Srl.

Les caractéristiques techniques et les informations contenues dans ce catalogue peuvent changer sans préavis. Les données sont sous réserve d'erreurs ou d'omissions. Le UFS peuvent à tout moment à sa discrétion et sans préavis modifier les outils inclus dans le catalogue. La reproduction de données et les images contenues dans le catalogue sont interdites, sauf autorisation écrite préalable de UFS Srl.



Attenzione: i maschi si possono scheggiare durante il loro impiego e si raccomanda l'uso degli occhiali o dello schermo protettivo.

Warning: taps can splinter during use; protective goggles or shield should therefore be used.

Àvertissement: les tarauds peuvent se briser dans leur utilisation; il est recommandé l'utilisation de lunettes ou écran de protection.

SOMMARIO *SUMMARY - RÉSUMÉ*

	L'azienda <i>The Company - La Société</i>	II ÷ III
	Interpretazione del codice <i>Interpretation of the code - Interprétation du code</i>	IV ÷ V
Pagine introduttive <i>Introduction pages</i> <i>Pages d'introduction</i>	Linee di prodotto principali e campi applicativi <i>Main product lines and application fields - Principales gammes de produits et domaines d'application</i>	VI ÷ VII
	Guida alla scelta del maschio <i>Guide to the choice of the tap - Guide de sélection des tarauds</i>	VIII ÷ XXII
	Indice prodotti <i>Product Index - Index des produits</i>	XXIII ÷ XXVIII
	Novità <i>New products - Nouveaux produits</i>	XXIX ÷ XLI
M - MJ	Filettatura metrica ISO passo grosso DIN13 <i>ISO Metric coarse thread DIN 13 - Filetage métrique ISO pas gros DIN13</i>	1 ÷ 79
MF - MJF	Filettatura metrica ISO passo fine DIN 13 <i>ISO metric fine thread DIN13 - Filetage métrique ISO pas fin DIN 13</i>	81 ÷ 148
UNC	Filettatura americana UNC passo grosso ASME B1.1 <i>UNC coarse thread ASME B1.1 - Filetage américain UNC pas gros ASME B1.1</i>	149 ÷ 163
UNF	Filettatura americana UNF passo fine ASME B1.1 <i>UNF fine thread ASME B1.1 - Filetage américain UNF pas fin ASME B1.1</i>	165 ÷ 179
UNEF	Filettatura americana UNEF passo extra fine ASME B1.1 <i>UNEF extra fine thread ASME B1.1 - Filetage américain UNEF pas extra fin ASME B1.1</i>	182 ÷ 184
UNS	Filettatura americana UNS speciale ASME B1.1 <i>UNS special thread ASME B1.1 - Filetage américain UNS spécial ASME B1.1</i>	185
8-12-16 UN	Filettatura americana UN ASME B1.1 <i>UN thread ASME B1.1 - Filetage américain UN ASME B1.1</i>	186
20-28-32 UN	Filettatura americana UN ASME B1.1 <i>UN thread ASME B1.1 - Filetage américain UN ASME B1.1</i>	187
GAS (BSP)	Filettatura GAS cilindrica Whitworth DIN EN ISO 228 <i>Whitworth pipe thread DIN EN ISO 228 - Filetage Gaz cylindrique Whitworth DIN EN ISO 228</i>	190 ÷ 203
Rp (BSPP)	Filettatura interna GAS cilindrica Whitworth ISO 7-1 <i>Cylindrical Whitworth internal pipe thread ISO 7-1 - Filetage Gaz cylindrique interne Whitworth ISO 7-1</i>	204
NPSM (NPSC)	Filettatura gas cilindrica americana sec. ANSI B1.20.1 <i>American Standard straight pipe thread acc. ANSI B1.20.1 - Filetage Gaz cylindrique américain ANSI B 1.20.1</i>	206
NPSF	Filettatura gas cilindrica americana sec. ANSI B1.20.3 <i>American Standard straight pipe thread acc. ANSI B1.20.3 - Filetage Gaz cylindrique américain ANSI B 1.20.3</i>	207
Rc (BSPT)	Filettatura gas conica Whitworth, conicità 1:16, ISO 7-1 <i>Tapered Whitworth pipe thread, taper 1:16, ISO 7-1 - Filetage Gaz conique Whitworth à cône 01:16, ISO 7-1</i>	210 ÷ 211
NPT	Filettatura gas conica americana, conicità 1:16 sec. ANSI/ASME B1.20.1 <i>American tapered pipe thread, taper 1:16 acc. ANSI/ASME B1.20.1</i> <i>Filetage gaz conique américain à cône 01:16 ANSI/ASME B 1.20.1</i>	212 ÷ 213
NPTF	Filettatura gas conica americana, conicità 1:16 sec. ANSI/ASME B1.20.3 <i>American tapered pipe thread, taper 1:16 acc. ANSI/ASME B1.20.3</i> <i>Filetage gaz conique américain à cône 01:16 ANSI/ASME B 1.20.3</i>	214
BSW	Filettatura Whitworth a passo grosso norma BS 84 <i>Whitworth thread standard BS 84 - Filetage Whitworth pas gros BS 84</i>	218 ÷ 221
PG	Filettatura per tubi corazzati DIN 40430 <i>Steel conduit thread DIN 40430 - Filetage pour tube blindés DIN 40430</i>	222
Tr	Filettatura ISO metrica trapezoidale DIN 103 <i>ISO Metric trapezoidal thread DIN 103 - Filetage ISO métrique trapézoïdal DIN 103</i>	223
Rd	Filettatura tonda DIN 405 <i>Round thread DIN 405 - Filetage rond DIN 405</i>	224
ISO529	Maschi corti ISO529 <i>ISO529 Short Taps - Tarauds courts ISO529</i>	226 ÷ 228
EG M	Filettatura ISO metrica DIN 8140-2 per filetti riportati <i>ISO Metric coarse thread DIN 8140-2 for wire thread inserts (STI)</i> <i>Filetage métrique ISO DIN8140-2 pour HELICOIL (Filet-Rapporté)</i>	229 ÷ 232
KOMBI	Maschi a macchina fora e filetta per acciaio e alluminio <i>Kombi Taps for steel and aluminium - Tarauds (Forets- Taraudeurs) pour acier et aluminium</i>	233 ÷ 234
Filiere / Dies	M, MF, UNC, UNF, GAS, Rc, NPT, BSW, PG	235 ÷ 246
Info	Informazioni tecniche (tabelle di filettatura, foratura e rivestimenti superficiali) <i>Technical information (threading's tables, drilling and types of coatings)</i> <i>Informations techniques (tableaux de filetage, perçage et revêtements)</i>	247 ÷ 278



About us



B2B

Con il nuovo servizio ON LINE B2B, accessibile dal nostro sito www.ufs.it, sarete in grado di visionare i prodotti del catalogo 31 con prezzi e disponibilità a magazzino.

Potrete ordinare direttamente ciò che Vi serve e cercare articoli alternativi. L'ordine sarà confermato e, a tal punto, diventerà effettivo.

Chiedeteci la password!

With new B2B online service accessible from our website www.ufs.it you will be able to view the products in the catalog 31 with a precise stock status updated every day. You can order what you need and search for similar items without losing time.

The order will be confirmed and, to this point, will become effective.

Ask us for the password!

Avec le nouveau service B2B en ligne accessible à partir de notre site Web www.ufs.it vous serez en mesure d'afficher les produits du catalogue 31 avec un état précis des stocks mis à jour tous les jours. Vous pouvez commander directement ce que vous avez besoin, chercher des objets similaires sans perdre de temps. L'ordre sera confirmé et, à ce point, entrera en vigueur. Demandez-nous le mot de passe !

Customer Service

0039-0124-818001 (int. 227) - customerservice@ufs.it

Informazioni *Information Informations*

customerservice@ufs.it

Direzione *Management Direction*

Graziano Doglietto

direzione@ufs.it

Stefano Doglietto

produzione@ufs.it

Area commerciale *Sales area Service commercial*

Graziano Doglietto - Direzione commerciale *Sales management Direction commerciale*

direzione@ufs.it

Gianfranco Viretto - Vendite Italia *Italian sales Ventes Italie*

commerciale@ufs.it

Daniele Chiarella - Vendite Estero *Foreign sales Ventes etranger*

sales@ufs.it

Dario Longoni *Export manager Export manager*

dario@longoniteam.com

Damiano Longoni *Export manager Export manager*

dam@longoniteam.com

Elisabetta Doglietto - Gestione ordini commerciali *Sales order management Gestion commandes clients*

ordini@ufs.it

Rosanna Blessent - Offerte commerciali *Commercial offers Offres commerciales*

offerte@ufs.it

Area tecnica *Technical area Service technique*

Stefano Doglietto - Direzione di produzione *Production management Directeur de production*

produzione@ufs.it

Ivan Cardamone - Assistenza tecnica clienti *Servicing department Assistance technique clients*

tecnico@ufs.it

Roberto Balaso - Ricerca & sviluppo *Research and development Recherche et developpement*

ricerca@ufs.it

Alex Marco - Ufficio tecnico e qualità *Technical and quality department Bureau technique et qualite*

qualita@ufs.it

Area logistica *Logistics area Logistique*

Elisabetta Doglietto

logistica@ufs.it

Area amministrativa *Administration Service administratif*

Fausto Cucciatti - Amministrazione e contabilità clienti *Administration and Customers Accountancy Administration et comptabilité clients*

amministrazione@ufs.it

Rosanna Blessent - Acquisti e contabilità fornitori *Purchasing and Suppliers Accountancy Achats et comptabilité fournisseur*

rosanna.blessent@ufs.it

Emilio Dini - Responsabile del personale *Personnel manager Responsable du personnel*

emilio.dini@ufs.it

Alessandro Faletto - Pianificazione *Production planning Planification de la production*

programmazione@ufs.it

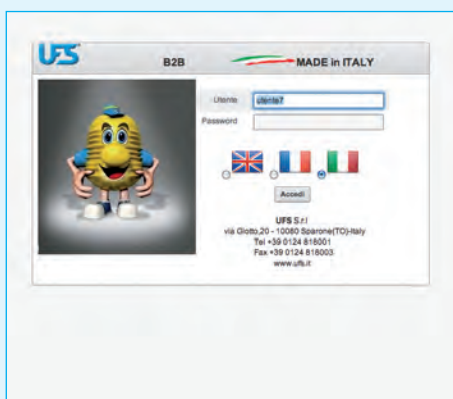

METODO DI COSTRUZIONE DEL CODICE UFS

METHOD OF FAST CONSTRUCTION OF THE UFS' CODE

MÉTHODE DE CONSTRUCTION DU CODE DE L'UFS









E	24	M	...	AZ	-	T
Materiale del maschio <i>Tap steel</i> <i>Matière du taraud</i>	Tipo di scanalatura <i>Flute type</i> <i>Type de goujure</i>	Tipo di filettatura del maschio <i>Threading type</i> <i>Type de filetage</i>	Spazio per l'indicazione del diametro <i>Diameter location</i> <i>Espace pour la désignation du diamètre</i>	Particolari tecnici aggiuntivi del maschio <i>Technical added information</i> <i>Détails techniques supplémentaires du taraud</i>	-	Tipo di trattamento o rivestimento superficiale <i>Tap coating or treatment surface</i> <i>Type de traitement ou revêtement</i>

FILETTATURE

THREADS
FILETAGES

SPIEGAZIONE SIMBOLI UFS

UFS' SYMBOLS CHART
EXPLICATION DES SYMBOLES UFS

M - new MJ	LH	Filettatura sinistra <i>Left hand thread</i> <i>Filetage à gauche</i>	
MF - new MJF	AZ	Filetti alternati <i>Interrupted threads</i> <i>Filets alternés</i>	
UNC	X	Applicazione per INOX <i>For stainless steel application</i> <i>Application pour acier inoxydable</i>	
UNF	OT	Applicazione specifica per OTTONE <i>Specific application for BRASS</i> <i>Application spécifique pour le laiton</i>	
UNEF	AL	Applicazione specifica per Alluminio <i>Specific application for Aluminium</i> <i>Application spécifique pour l'aluminium</i>	
UNS	NI	Applicazione specifica per Nichel <i>Specific application for Nickel</i> <i>Application spécifique pour le Nickel</i>	
8-UN	FOR	Lubrificazione interna con uscita assiale <i>Through coolant, axial flow</i> <i>Lubrification interne avec sortie axial</i>	
12-UN	FORY	Lubrificazione interna con uscita radiale <i>Through coolant, radial flow</i> <i>Lubrification interne avec sortie radiale</i>	
16-UN	SP	Senza punta anteriore <i>Without centre male</i> <i>Sans pointe avant</i>	
20-UN		Maschiatura rigida sincronizzata <i>Rigid tapping Synchro</i> <i>Taraudage rigide synchronisé</i>	
28-UN		Maschiatura convenzionale <i>Conventional tapping</i> <i>Taraudage conventionel</i>	
32-UN		Lavorazione con macchine CNC in maschiatura rigida <i>Tapping with CNC machines</i> <i>Taraudage avec CNC machines</i>	
GAS			
Rp			
NPSM			
NPSF			
Rc			
NPT			
NPTF			
BSW			
PG			
Tr			
Rd			
EGM			

CLASSI DI MATERIALI PER MASCHI STANDARD

MATERIAL TYPE FOR STANDARD TAPS

CLASSES DE MATÉRIAUX POUR TARAUD STANDARD

Acciai super rapidi High speed steel Acier super rapide			Acciai sinterizzati da polveri Powdered metallurgy high speed steel Acier fritté		Metallo duro Solid carbide Carbure	
HSS	E	V	P	K	XT	HM
	HSSE	HSSV3	HSSP 8%Co	PM3	PM1	MDI/HM
	R < 850 N/mm ²	R < 1000 N/mm ²	R < 1000 N/mm ²	R < 1400 N/mm ² < 45 HRC	R < 1800 N/mm ² < 52 HRC	45÷62 HRC

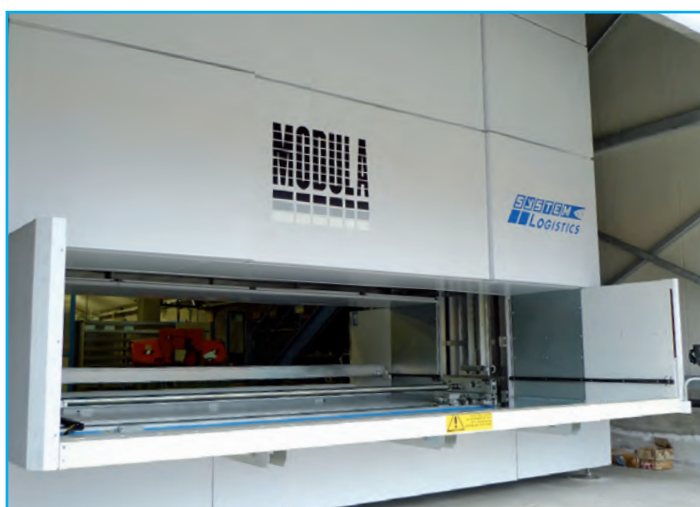

Gestione acciai con magazzino automatico verticale
Automatic load system for steels' storage
Gestion d'un entrepôt vertical automatique pour l'acier



Gestione prodotti finiti con magazzino automatico verticale
Automatic load system for taps steels' storage
Gestion des produits finis avec entrepôt vertical automatique

TIPI DI SCANALATURA

FLUTE TYPE

TYPES DE GOUJURES

20	Tagli Diritti (DIN 371) Straight flutes Goujures Droites	42	Elica 10° - 15° dx per Ti e Ni (DIN 371) Spiral flutes 15° R for Ti and Ni Hélice 10° - 15° à droite pour Ti et Ni	80	El 40° dx, rastremazione posteriore (DIN371) Spiral flutes 40° R, back tapered tread Hélice 40° à droite, Détalonnage arrière
21	Tagli Diritti (DIN 376) Straight flutes Goujures Droites	43	Elica 10° - 15° dx per Ti e Ni (DIN 376) Spiral flutes 15° R for Ti and Ni Hélice 10° - 15° à droite pour Ti et Ni	81	El 40° dx, rastremazione posteriore (DIN376) Spiral flutes 40° R, back tapered tread Hélice 40° droit, Détalonnage arrière
24	Imbocco Corretto (DIN 371) Spiral pointed Entrée GUN	50	Elica 15° sinistra (DIN 371) Spiral flutes 15° LH Hélice 15° à gauche	82	Elica 45° - 48° dx (DIN 371) Spiral flutes 45° - 48° R Hélice 45° - 48° à droite
25	Imbocco Corretto (DIN 376) Spiral pointed Entrée GUN	51	Elica 15° sinistra (DIN 376) Spiral flutes 15° LH Hélice 15° à gauche	83	Elica 45° - 48° dx (DIN 376) Spiral flutes 45° - 48° R Hélice 45° - 48° à droite
26	Tagli diritti per GHISA (DIN 371) Straight flutes for cast iron Goujures Droites pour FONTE	52	Elica 10° - 15° sin. per Ti e Ni (DIN 371) Spiral flutes 15° LH for Ti and Ni Hélice 10° - 15° à gauche pour Ti et Ni	92	Elica 45° dx (DIN371) Spiral flutes 45° Hélice 45° à droite
27	Tagli diritti per GHISA (DIN 376) Straight flutes for cast iron Goujures Droites pour FONTE	53	Elica 10° - 15° sin. per Ti e Ni (DIN 376) Spiral flutes 15° LH for Ti and Ni Hélice 10° - 15° à gauche pour Ti et Ni	93	Elica 45° dx (DIN376) Spiral flutes 45° Hélice 45° à droite
28	Elica 25° dx (DIN 371) Spiral flutes 25° R Hélice 25° à droite	60	Elica 40° dx (DIN 371) Spiral flutes 40° R Hélice 40° à droite	94	Elica 45° dx (DIN371) Spiral flutes 45° Hélice 45° à droite
29	Elica 25° dx (DIN 376) Spiral flutes 25° R Hélice 25° à droite	61	Elica 40° dx (DIN 376) Spiral flutes 40° R Hélice 40° à droite	95	Elica 45° dx (DIN376) Spiral flutes 45° Hélice 45° à droite
40	Elica 15° dx (DIN 371) Spiral flutes 15° R Hélice 15° à droite	70	Elica 45° dx per Alluminio (DIN 371) Spiral flutes 45° R for Aluminium Hélice 45° à droite pour Al		
41	Elica 15° dx (DIN 376) Spiral flutes 15° R Hélice 15° à droite	71	Elica 45° dx per Alluminio (DIN 376) Spiral flutes 45° R for Aluminium Hélice 45° à droite pour Al		



LINEE PRODOTTI

PRODUCTS LINES

GAMMES DE PRODUITS



						
Universal	HR	INOX <i>Stainless steel Acier inoxydable</i>	Al-Cu-Fe	Ghisa <i>Cast iron Fonte</i>	Ti	Ni
						
SR Synchro RIGID	MDI-HR Metallo duro <i>Solid Carbide Carbure</i>	X-SERIES Rullare <i>Roll form taps Tarauds à refouler</i>	K-ROLL Rullare <i>Roll form taps Tarauds à refouler</i>			



Usò generale $R < 1000 \text{ N/mm}^2$, acciaio HSSP 8%Co
General purpose $R < 1000 \text{ N/mm}^2$, HSSP steel 8%Co
Usage Général $R < 1000 \text{ N/mm}^2$, Acier HSSP 8% Co



Linea standard HSSE, HSS
Standard line HSSE, HSS
Ligne standard HSSE, HSS

CAMPI APPLICATIVI

APPLICATION FIELD

DOMAINES D'APPLICATION

N	USO GENERALE <i>General purpose - Usage Général</i>
N	USO GENERALE $R \leq 1000\text{N/mm}^2$ <i>General purpose $R \leq 1000\text{N/mm}^2$ - Usage Général $R \leq 1000\text{N/mm}^2$</i>
U	APPLICAZIONI UNIVERSALI $R \leq 1200\text{ N/mm}^2$ <i>Universal Applications $R \leq 1200\text{ N/mm}^2$ - Applications universelles $R \leq 1200\text{ N/mm}^2$</i>
HR	ALTA RESISTENZA <i>High Resistance - Haute Résistance</i>

INOX	ACCIAIO INOSSIDABILE <i>Stainless steel - Acier inoxydable</i>
-------------	--

GG	GHISA <i>Cast Iron - Fonte</i>
-----------	--

Al-Cu-Fe	ALLUMINIO, RAME, ACCIAIO $R \leq 700\text{ N/mm}^2$ <i>Aluminium, Cooper, Steel $R \leq 700\text{ N/mm}^2$ - Aluminium, cuivre, acier $R \leq 700\text{ N/mm}^2$</i>
-----------------	---

OT	OTTONE E BRONZO <i>Brass and Bronze - Laiton et Bronze</i>
-----------	--

Ti	TITANIO <i>Titanium - Titane</i>
-----------	--

Ni	NICHEL <i>Nickel - Nickel</i>
-----------	---

SYNCHRO RIGID	MASCHIATURA RIGIDA SINCRONIZZATA <i>Rigid Tapping Synchro - Taraudage rigide synchronisé</i>
----------------------	--

MDI-HR	METALLO DURO INTEGRALE - ALTA RESISTENZA <i>Solid carbide, high resistance - Carbure, haute résistance</i>
---------------	--

K-ROLL	MASCHI A RULLARE <i>Roll form taps - Tarauds à refouler</i>
---------------	---

P - SERIES	MASCHI A RULLARE <i>Roll form taps - Tarauds à refouler</i>
-------------------	---

X - SERIES	MASCHI A RULLARE <i>Roll form taps - Tarauds à refouler</i>
-------------------	---

MDI -SERIES	MASCHI A RULLARE <i>Roll form taps - Tarauds à refouler</i>
--------------------	---

Maschi a mano, serie 3 pezzi Hand taps, 3 pieces set Tarauds à main, série 3 pièces			Maschi a mano, serie 2 pezzi Hand taps, 2 pieces set Tarauds à main, série 2 pièces		Maschi a mano sinistri LH, serie 3 pezzi Hand taps 3 pieces set - Left LH Tarauds à main à gauche, série 3 pièces			M. a mano sinistri, 2 pezzi Hand taps 2 pieces set - Left LH T. à main à gauche, s. 3 pièces		Maschi a mano per INOX Hand taps 3 pieces set - Stainless steel Tarauds à main, Inox				...
01...	02...	03...	01...	03...	01...LH	02...LH	03...LH	01...LH	03...LH	01...X-VS	02...X-VS	03...X-VS	10FC...	
LINE	LINE	LINE	LINE	LINE	LINE	LINE	LINE	LINE	LINE	LINE	LINE	LINE	LINE	
00...	00...	00...	00...	00...	00...LH	00...LH	00...LH	00...LH	00...LH	00...X-VS	00...X-VS	00...X-VS		
					LH	LH	LH							
2-3	2-3	2-3			4	4	4			5	5	5	6	
			82-84	82-84				85	85					
150	150	150	166	166										
			190	190										
218	218	218												
A (5-6)	D (4-5)	C (2-3)	A (5-6)	C (2-3)	A (5-6)	D (4-5)	C (2-3)	A (5-6)	C (2-3)	A (5-6)	D (4-5)	C (2-3)	C (2-3)	
HSS	HSS	HSS	HSS	HSS	HSS	HSS	HSS	HSS	HSS	HSS	HSS	HSS	HSSE	
Br	Br	Br	Br	Br	Br	Br	Br	Br	Br	VS	VS	VS	Br	
N	N	N	N	N	N	N	N	N	N	INOX	INOX	INOX	N	
2xD	2xD	2xD	2xD	2xD	2xD	2xD	2xD	2xD	2xD	2xD	2xD	2xD	1,5xD	
1.1	■		■			■			■		■		■ 10-15	
1.2	■		■			■			■		■		■ 10-15	
1.3	■		■			■			■		■		■ 10-12	
1.4	■		■			■			■		■		○ 8-10	
1.5											○			
1.6														
1.7														
1.8														
2.1	■		■			■			■		■			
2.2	○		○			○			○		■			
2.3	○		○			○			○		■			
2.4														
3.1	○		○			○			○		■			
3.2											○			
3.3											○			
3.4	○		○			○			○		■			
3.5														
4.1	■		■			■			■		■			
4.2	■		■			■			■		■			
4.3	■		■			■			■		■			
4.4	○		○			○			○		■			
4.5														
4.6														
5.1	■		■			■			■		■			
5.2	■		■			■			■		■			
5.3	○		○			○			○		■			
5.4														
6.1														
6.2														
6.3														
7.1														
7.2														
7.3														
8.1														
8.2														
8.3														
9.1														
9.2														
9.3														
10.1														

... per dadi ... for nuts ... pour écrous		Scanalature diritte per OTTONE Straight flutes for BRASS Goujures Droites pour LAITON				Scanalature diritte Straight flutes Goujures Droites			Scanalature diritte - sinistri LH Straight flutes - left LH Goujures Droites - à gauche LH			Filetti alternati AZ... Interrupted threads taps... Filets alternés AZ...	
10FP...	12FP...	LANCIA...	LANCIA...NC	E20...OT	E20...OT-CT	E20/E21...	E20/E21...V	E20/E21...T	E20/E21...LH	E20/E21...LH-V	E20/E21...LH-T	E20/E21...AZ	E20/E21...AZ-V
LINE	LINE	LINE	LINE	LINE	LINE	LINE	LINE	LINE	LINE	LINE	LINE	LINE	LINE
6	6	Ms58 7	Ms58 7	7	7	8-9	8-9	8-9	LH 10	LH 10	LH 10	AZ 11	AZ 11
						86-92		86-88			93		
						151		151					
						167		167					
						182		182					
						185		185					
						186							
						187		187					
						191, (204 Rp)		191, (204 Rp)					
						206		206					
						207		207					
						219		219					
						222 (PG)		222 (PG)					
						230		230					
20xP	6-8xP	C (2-3)	C (2-3)	C (2-3)	C (2-3)	C (2-3)	C (2-3)	C (2-3)	C (2-3)	C (2-3)	C (2-3)	C (2-3)	C (2-3)
HSSE	HSSE	HSSE	HSSE	HSSE	HSSE	HSSE	HSSE	HSSE	HSSE	HSSE	HSSE	HSSE	HSSE
Br	Br	Br	CrN	Br	TiCN	Br	V	TiN	Br	V	TiN	Br	V
N	N	OT	OT	OT	OT	N	N	N	N	N	N	Al-Cu-Fe	Al-Cu-Fe
1,5xD	3xD	3xD	3xD	3xD	3xD	1,5xD	1,5xD	1,5xD	1,5xD	1,5xD	1,5xD	1,5xD	1,5xD
1.1	■ 10-15	■ 10-15				○ 10-15	■ 10-15	■ 20-30	○ 10-15	■ 10-15	■ 20-30	■ 10-15	■ 10-15
1.2	■ 10-15	■ 10-15				■ 10-15	■ 10-15	■ 20-30	■ 10-15	■ 10-15	■ 20-30		
1.3	■ 10-12	■ 10-12				■ 10-12	■ 10-12	■ 20-25	■ 10-12	■ 10-12	■ 20-25		
1.4	○ 8-10	○ 8-10				○ 8-10	○ 8-10	■ 15-20	○ 8-10	○ 8-10	■ 15-20		
1.5													
1.6													
1.7													
1.8													
2.1													
2.2													
2.3													
2.4													
3.1													
3.2													
3.3													
3.4						○ 8-10	○ 8-10	○ 15-20	○ 8-10	○ 8-10	○ 15-20		
3.5													
4.1												○ 10-15	○ 10-15
4.2						○ 15-20	○ 15-20	○ 25-30	○ 15-20	○ 15-20	○ 25-30	■ 15-20	■ 15-20
4.3						○ 10-15	○ 10-15	○ 20-25	○ 10-15	○ 10-15	○ 20-25		
4.4													
4.5													
4.6													
5.1													
5.2						○ 10-15	○ 10-15	○ 20-25	○ 10-15	○ 10-15	○ 20-25	○ 8-12	○ 8-12
5.3		■ 15-20	■ 25-30	■ 15-20	■ 25-30	○ 15-20	○ 15-20	○ 25-30	○ 15-20	○ 15-20	○ 25-30	■ 10-15	■ 10-15
5.4													
6.1													
6.2													
6.3													
7.1													
7.2													
7.3													
8.1												○ 20-25	○ 20-25
8.2		○ 8-10	○ 10-15	○ 8-10	○ 10-15	○ 8-10	○ 8-10	○ 10-15	○ 8-10	○ 8-10	○ 10-15		
8.3		○ 3-5	○ 6-10	○ 3-5	○ 6-10								
9.1													
9.2													
9.3													
10.1													

Elica 15° - HR Helix 15° - HR Hélice 15° - HR		Elica 15° - Titanio Helix 15° - Titanium Hélice 15° - Titane			Elica 10° - Nickel Helix 10° - Nickel Hélice 10° - Nickel			Elica 40° Helix 40° Hélice 40°						
K40/K41...TXC	K40/K41...FOR-TXC	K42/K43...V	K42/K43...CT	K28/K29...AZ-V	K42...NI	K42...NI-CT	K28/K29...V	E60/E61...	E60/E61...V	E60/E61...T	E60/E61...TXC	E60/E61...FOR	E60/E61...FOR-T	
TOP	TOP	TOP	TOP	TOP	TOP	TOP	TOP	LINE	LINE	LINE	LINE	LINE	LINE	
		Ti	Ti	Ti-AZ	Ni	Ni	Ni							
R15°	R15°	R15°	R15°	R25°	R10°	R10°	R25°	R40°	R40°	R40°	R40°	R40°	R40°	
43	43	44	44	44	45	45	45	46-47	46-47	46-47	46-47 (TXC)	48	48	
		44 (MJ)			45			50			50			
								50			50			
								51			51			
		120	120		121	121		122-126	122-126	122-126	122-126(TXC)	127	127	
		120			121			129						
								129						
		158	158					159	159	159	159			
		174	174					175	175	175	175			
								184			184			
								198	198	198	198			
								221	221	221	221			
								232			232			
C (2-3)	C (2-3)	C (2-3)	C (2-3)	C (2-3)	C (2-3)	C (2-3)	C (2-3)	C (2-3)	C (2-3)	C (2-3)	C (2-3)	C (2-3)	C (2-3)	
PM3	PM3	PM3	PM3	PM3	PM3	PM3	PM3	HSSE	HSSE	HSSE	HSSE	HSSE	HSSE	
TXC	TXC	V	TiCN	V	Br	TiCN	V	Br	V	TiN	TXC/XP	Br	TiN	
HR	HR	Ti	Ti	Ti	Ni	Ni	Ni	N	N	N	N	N	N	
1,5xD	2,5xD	1,5xD	1,5xD	2,5xD	1,5xD	1,5xD	2,5xD	2,5xD	2,5xD	2,5xD	2,5xD	3xD	3xD	
1.1								○ 10-15	■ 10-15	■ 20-30	■ 20-30	○ 10-15	■ 20-30	
1.2								■ 10-15	■ 10-15	■ 20-30	■ 20-30	■ 10-15	■ 20-30	
1.3								■ 10-12	■ 10-12	■ 20-25	■ 20-25	■ 10-12	■ 20-25	
1.4								○ 8-10	○ 8-10	■ 15-20	■ 15-20	○ 8-10	■ 15-20	
1.5	■ 5-12	■ 5-12												
1.6	■ 5-8	■ 5-8		■ 5-8										
1.7														
1.8														
2.1														
2.2												○ 10-15		
2.3												○ 8-10		
2.4				■ 6-8										
3.1														
3.2														
3.3	■ 15-20	■ 15-20		■ 15-20						○ 10-15	○ 10-15		○ 10-15	
3.4	■ 20-25	■ 20-25		■ 20-25						■ 15-20	■ 15-20		■ 15-20	
3.5														
4.1								○ 10-15	■ 10-15	○ 20-25	○ 20-25	○ 10-15	○ 20-25	
4.2								■ 15-20	■ 15-20	■ 25-30	■ 25-30	■ 15-20	■ 25-30	
4.3										○ 20-25	○ 20-25		○ 20-25	
4.4	○ 25-30	○ 25-30		○ 25-30										
4.5	■ 20-30	■ 20-30												
4.6	■ 20-30	■ 20-30												
5.1								○ 8-12	■ 8-12	○ 15-20		○ 8-12	○ 15-20	
5.2								○ 10-15	■ 10-15	■ 20-25	■ 20-25	○ 10-15	■ 20-25	
5.3	■ 25-30	■ 25-30		■ 25-30										
5.4				○ 5-8			■ 5-8							
6.1			■ 5-10		■ 5-10									
6.2				■ 4-8	■ 4-8									
6.3				■ 2-4										
7.1									■ 6-8					
7.2				■ 2-4			■ 2-4		■ 2-4					
7.3							■ 2-3							
8.1														
8.2														
8.3														
9.1														
9.2				■ 1-2					■ 3-5					
9.3								■ 2-3						
10.1														

		Maschi a rullare con canalini - PM3 Roll taps with oil groove - PM3 Tarauds à refouler avec rainures - PM3				Maschi a rullare con canalini e forati Roll taps with oil groove - internal coolant T. à refouler avec rainures - lubrification interne			Maschi a rullare imbocco E Roll taps chamfer E Tarauds à refouler entrée E			Maschi a rullare MDI Roll taps hard material HM Tarauds à refouler Carbure		Maschi conici CORTI Taps tapered shorts Tarauds conique courts	
		X2SC...CT	X2CC...NC	X2CC...TG	X2CC...CT	X2CC...TXX	X2CC...FOR-TG	X2CC...FOR-TG	X2SCE...TG	X2CCE...TG	X2CCE...FOR-TG	HM2SC...FOR-T	HM2CC...FOR-CT	E21C...	E41C...V
		TOP	TOP	TOP	TOP	TOP	TOP	TOP	TOP	TOP	TOP	TOP	TOP	LINE	LINE
			Al, Cu, Fe												
		X-series	X-series	X-series	X-series	X-series	X-series	X-series	X-series	X-series	X-series	X-series	X-series	con1:16	con1:16
		74	75	75	75	76	76	76	77	77	77	78	78		
				75 new											
				144		145	145	145	146	146	146				
				144											
				202			202								
														210	210
														212	212
														214	214
		C (2-3)	C (2-3)	C (2-3)	C (2-3)	C (2-3)	C (2-3)	C (2-3)	E (1,5-2)	E (1,5-2)	E (1,5-2)	C (2-3)	C (2-3)	C (2-3)	C (2-3)
		PM3	PM3	PM3	PM3	PM3	PM3	PM3	PM3	PM3	PM3	MDI/HM	MDI/HM	HSSE	HSSE
		TiCN	CrN	TiN-G	TiCN	TiCN	TiN-G	TiN-G	TiN-G	TiN-G	TiN-G	TiN	TiCN	Br	V
		N	N	N	N	N	N	N	N	N	N	N	N	N	N
		3xD	3xD	3xD	3xD	3xD	3xD	3xD	3xD	3xD	3xD	3xD	3xD	-	-
1.1		■ 30-40	■ 30-40	■ 30-40	■ 30-40	■ 30-40	■ 30-40	■ 30-40	■ 30-40	■ 30-40	■ 30-40	■ 30-50	■ 30-50	○ 3-5	○ 3-5
1.2		■ 30-40	■ 30-40	■ 30-40	■ 30-40	■ 30-40	■ 30-40	■ 30-40	■ 30-40	■ 30-40	■ 30-40	■ 30-50	■ 30-50	■ 3-5	■ 3-5
1.3		■ 30-35	■ 30-35	■ 30-35	■ 30-35	■ 30-35	■ 30-35	■ 30-35	■ 30-35	■ 30-35	■ 30-35	■ 30-45	■ 30-45	■ 5-7	■ 5-7
1.4		■ 25-30	■ 25-30	■ 25-30	■ 25-30	■ 25-30	■ 25-30	■ 25-30	■ 25-30	■ 25-30	■ 25-30	■ 30-40	■ 30-40	○ 4-6	■ 4-6
1.5		○ 10-15		○ 10-15	○ 10-15		○ 10-15	○ 10-15	○ 10-15	○ 10-15	○ 10-15	○ 20-30	○ 20-30		
1.6															
1.7															
1.8															
2.1		■ 10-15		■ 10-15	■ 10-15		■ 10-15	■ 10-15	■ 10-15	■ 10-15	■ 10-15	■ 20-25	■ 20-25		○ 3-5
2.2		■ 10-12		■ 10-12	■ 10-12		■ 10-12	■ 10-12	■ 10-12	■ 10-12	■ 10-12	■ 15-20	■ 15-20		○ 2-4
2.3		■ 6-10		■ 6-10	■ 6-10		■ 6-10	■ 6-10	■ 6-10	■ 6-10	■ 6-10	■ 10-15	■ 10-15		■ 2-3
2.4		○ 6-8		○ 6-8	○ 6-8		○ 6-8	○ 6-8	○ 6-8	○ 6-8	○ 6-8	○ 10-15	○ 10-15		
3.1															○ 5-7
3.2															○ 3-5
3.3														○ 3-5	■ 3-5
3.4														○ 5-7	■ 5-7
3.5															
4.1		■ 35-40	■ 35-40	■ 35-40	■ 35-40	■ 35-40	■ 35-40	■ 35-40	■ 35-40	■ 35-40	■ 35-40	■ 40-50	■ 40-50		
4.2		■ 40-45	■ 40-45	■ 40-45	■ 40-45	■ 40-45	■ 40-45	■ 40-45	■ 40-45	■ 40-45	■ 40-45	■ 50-60	■ 50-60	○ 10-15	○ 10-15
4.3		■ 35-40	■ 35-40	■ 35-40	■ 35-40	■ 35-40	■ 35-40	■ 35-40	■ 35-40	■ 35-40	■ 35-40	■ 40-50	■ 40-50	○ 10-15	■ 10-15
4.4															○ 6-8
4.5															
4.6															
5.1		○ 15-20	■ 15-20	○ 15-20	○ 15-20	■ 15-20	○ 15-20	○ 15-20	○ 15-20	○ 15-20	○ 15-20	○ 30-40	○ 30-40		
5.2		○ 15-20	■ 15-20	○ 15-20	○ 15-20	■ 15-20	○ 15-20	○ 15-20	○ 15-20	○ 15-20	○ 15-20	○ 30-40	○ 30-40		○ 5-7
5.3														○ 8-12	■ 8-12
5.4															
6.1			■ 10-20												
6.2															
6.3															
7.1		■ 15-20		■ 15-20	■ 15-20		■ 15-20	■ 15-20	■ 15-20	■ 15-20	■ 15-20	■ 30-35	■ 30-35		
7.2		○ 5-8		○ 5-8	○ 5-8		○ 5-8	○ 5-8	○ 5-8	○ 5-8	○ 5-8	○ 10-15	○ 10-15		
7.3															
8.1															
8.2															
8.3															
9.1															
9.2															
9.3															
10.1															

INDICE PRODOTTI

PRODUCTS INDEX

INDEX DES PRODUITS

Filettatura-Thread-Filetage				Filettatura-Thread-Filetage				Filettatura-Thread-Filetage			
M				M				M			
CODICE - code	pg. list.	pg. cat.	Typ.	CODICE - code	pg. list.	pg. cat.	Typ.	CODICE - code	pg. list.	pg. cat.	Typ.
00M	1	002-003	Line	E24M...TZ	15	026	Line	E41M...AZ	23	041	Line
00M...LH	2	004	Line	E24M...V	11	020	Line	E41M...AZ-V	23	041	Line
00M...X-VS	3	005	Line	E25M...X-V	18	032	Line	E41M...FOR	21	038	Line
01M	1	002-003	Line	E25M...	11	021	Line	E41M...FOR-T	21	038	Line
01M...LH	2	004	Line	E25M...+0,1	14	024	Line	E41M...NC	24	041	Line
01M...X-VS	3	005	Line	E25M...4H	12	023	Line	E41M...T	21	037	Line
02M	1	002-003	Line	E25M...-6G	13	023	Line	E41M...T+0,1	23	040	Line
02M...LH	2	004	Line	E25M...-7G	13	024	Line	E41M...T-4H	22	039	Line
02M...X-VS	3	005	Line	E25M...AL-TXC	15	026	Top	E41M...T-6G	22	039	Line
03M	2	002-003	Line	E25M...AL-VS	14	026	Line	E41M...T-7G	23	040	Line
03M...LH	2	004	Line	E25M...AZ	15	027	Line	E41M...TZ	23	041	Line
03M...X-VS	3	005	Line	E25M...AZ-TXC	15	027	Top	E41M...V	21	037	Line
10FCM...	3	006	Line	E25M...AZ-TZ	15	027	Line	E41M...XP	21	037	Line
10FPM...	3	006	Line	E25M...LH	12	022	Line	E50M...	18	033	Line
12FPM...	3	006	Line	E25M...LH-T	12	022	Line	E50M...V	19	033	Line
E20M...	4	008	Line	E25M...LH-V	12	022	Line	E50M...XP	19	033	Line
E20M...AZ	6	011	Line	E25M...NC	15	027	Line	E51M...	19	033	Line
E20M...AZ-TXC	6	011	Top	E25M...T	11	021	Line	E51M...V	19	033	Line
E20M...AZ-V	6	011	Line	E25M...T+0,1	14	024	Line	E51M...XP	19	033	Line
E20M...LH	5	010	Line	E25M...T-4H	13	023	Line	E60M...CP-T	27	046	Line
E20M...LH-T	6	010	Line	E25M...T-6G	13	023	Line	E60M...CP-TXC	27	046	Line
E20M...LH-V	6	010	Line	E25M...T-7G	13	024	Line	E60M...CP-V	27	046	Line
E20M...-OT	4	007	Line	E25M...TXC	12	021	Line	E60M...	26	046	Line
E20M...-OT-CT	4	007	Line	E25M...TZ	15	026	Line	E60M...+0,1	30	051	Line
E20M...SP	4	008	Line	E25M...V	11	021	Line	E60M...-4H	29	050	Line
E20M...SP-T	5	008	Line	E26M...FOR-CT	7	012	Line	E60M...6G	29	050	Line
E20M...SP-V	4	008	Line	E26M...NQ	7	012	Line	E60M...-7G	30	051	Line
E20M...T	5	008	Line	E26M...SP-NQ	7	012	Line	E60M...CP	26	046	Line
E20M...V	4	008	Line	E27M...FOR-CT	7	013	Line	E60M...FOR	28	048	Line
E21M	5	009	Line	E27M...NQ	7	013	Line	E60M...FOR-T	28	048	Line
E21M...AZ	6	011	Line	E27M...SP-NQ	7	013	Line	E60M...FOR-TXC	28	048	Line
E21M...AZ-TXC	6	011	Top	E26M...CT	7	012	Line	E60M...LH	28	049	Line
E21M...AZ-V	6	011	Line	E26M...SP-CT	7	012	Line	E60M...LH-V	29	049	Line
E21M...LH	5	010	Line	E27M...CT	7	013	Line	E60M...LH-XP	29	049	Line
E21M...LH-T	6	010	Line	E27M...SP-CT	7	013	Line	E60M...NC	32	055	Line
E21M...LH-V	6	010	Line	E40M...	20	036	Line	E60M...T	27	046	Line
E21M...T	5	009	Line	E40M...+0,1	23	040	Line	E60M...TXC	27	046	Line
E21M...V	5	009	Line	E40M...-4H	22	039	Line	E60M...V	27	046	Line
E24M...X-V	18	032	Line	E40M...-6G	22	039	Line	E60M...XP+0,1	30	051	Line
E24M...	10	020	Line	E40M...-7G	22	040	Line	E60M...XP-4H	29	050	Line
E24M...+0,1	14	024	Line	E40M...AZ	23	041	Line	E60M...XP-6G	30	050	Line
E24M...4H	12	023	Line	E40M...AZ-V	23	041	Line	E60M...XP-7G	30	051	Line
E24M...-6G	13	023	Line	E40M...FOR	21	038	Line	E61M...+0,1	30	051	Line
E24M...-7G	13	024	Line	E40M...FOR-T	21	038	Line	E61M...-4H	29	050	Line
E24M...AL	14	026	Line	E40M...NC	24	041	Line	E61M...6G	29	050	Line
E24M...AL-TXC	15	026	Top	E40M...T	20	036	Line	E61M...FOR	28	048	Line
E24M...AL-VS	14	026	Line	E40M...T+0,1	23	040	Line	E61M...FOR-T	28	048	Line
E24M...AZ	15	027	Line	E40M...T-4H	22	039	Line	E61M...FOR-TXC	28	048	Line
E24M...AZ-TXC	15	027	Top	E40M...T-6G	22	039	Line	E61M...LH	28	049	Line
E24M...AZ-TZ	15	027	Line	E40M...T-7G	23	040	Line	E61M...LH-V	29	049	Line
E24M...LH	12	022	Line	E40M...TZ	23	041	Line	E61M...LH-XP	29	049	Line
E24M...LH-T	12	022	Line	E40M...V	20	036	Line	E61M...XP+0,1	30	051	Line
E24M...LH-V	12	022	Line	E40M...XP	20	036	Line	E61M...XP-4H	29	050	Line
E24M...NC	15	027	Line	E41M...	21	037	Line	E61M...XP-6G	30	050	Line
E24M...T	11	020	Line	E41M...+0,1	23	040	Line	E61M...	27	047	Line
E24M...T+0,1	14	024	Line	E41M...-4H	22	039	Line	E61M...-7G	30	051	Line
E24M...T-4H	13	023	Line	E41M...-6G	22	039	Line	E61M...NC	32	055	Line
E24M...T-6G	13	023	Line	E41M...-7G	22	040	Line	E61M...T	28	047	Line
E24M...T-7G	13	024	Line					E61M...TXC	28	047	Line
E24M...TXC	11	020	Line					E61M...V	27	047	Line

INDICE PRODOTTI

PRODUCTS INDEX

INDEX DES PRODUITS

Filettatura-Thread-Filetage				Filettatura-Thread-Filetage				Filettatura-Thread-Filetage			
M				M				M			
CODICE - code	pg. list.	pg. cat.	Typ.	CODICE - code	pg. list.	pg. cat.	Typ.	CODICE - code	pg. list.	pg. cat.	Typ.
E61M...XP-7G	30	051	Line	K26M...FORY-TX	8	014	Top	K83M...X-TXC	37	065	Top
E70M...	31	054	Line	K26M...SP-TX	8	014	Top	L24M...	14	025	Line
E70M...TXC	31	054	Top	K26M...TX	8	014	Top	L24M...CT	14	025	Line
E70M...TZ	31	054	Line	K26M...TXS	8	014	Top	L25M...	14	025	Line
E70M...VS	31	054	Line	K27EM...FOR-TX	8	015	Top	E25M...AL	14	026	Line
E71M...	31	054	Line	K27EM...FORY-TX	9	015	Top	L25M...CT	14	025	Line
E71M...TXC	31	054	Top	K27EM...TX	8	015	Top	L60...CT	31	053	Line
E71M...TZ	31	054	Line	K27M...FOR-TX	8	014	Top	L60M...	31	053	Line
E71M...VS	31	054	Line	K27M...FORY-TX	8	014	Top	L61...CT	31	053	Line
E80M...X-V	37	064	Line	K27M...TXS	8	014	Top	L61M...	31	053	Line
E80M...	33	058	Line	K27M...TX	8	014	Top	LANCIAM...	4	007	Line
E80M...T	34	058	Line	K28M...	36	062	Top	LANCIAM...NC	4	007	Line
E80M...V	33	058	Line	K28M...AZ-V	26	044	Top	P24M...	16	028	Plus
E80M...XP	34	058	Line	K28M...CT	36	062	Top	P24M...CT	16	028	Plus
E81M...X-V	37	064	Line	K28M...FOR-CT	36	062	Top	P24M...T	16	028	Plus
E81M...	33	058	Line	K28M...V	26	045	Top	P24M...V	16	028	Plus
E81M...T	34	058	Line	K29M...	36	062	Top	P25M...	16	028	Plus
E81M...V	33	058	Line	K29M...AZ-V	26	044	Top	P25M...CT	16	028	Plus
E81M...XP	34	058	Line	K29M...CT	36	062	Top	P25M...T	16	028	Plus
E82M...	34	059	Line	K29M...FOR-CT	36	062	Top	P25M...V	16	028	Plus
E82M...T	34	059	Line	K29M...V	26	045	Top	P2CCM...	38	070	Line
E82M...V	34	059	Line	K40M...FOR-TXC	25	043	Top	P2CCM...FP	40	072	Line
E82M...XP	34	059	Line	K40M...TXC	25	043	Top	P2CCM...FP-T	40	072	Line
E83M...	34	059	Line	K41M...FOR-TXC	25	043	Top	P2CCM...LH	40	073	Line
E83M...T	34	059	Line	K41M...TXC	25	043	Top	P2CCM...LH-T	40	073	Line
E83M...V	34	059	Line	K42M...CT	25	044	Top	P2CCM...SP	38	070	Line
E83M...XP	34	059	Line	K42M...NI	26	045	Top	P2CCM...SP-T	39	070	Line
HM20M...FOR	10	019	Top	K42M...NI-4HX	26	045	Top	P2CCM...SP-V	39	070	Line
HM20M...FOR-CT	10	019	Top	K42M...NI-CT	26	045	Top	P2CCM...T	39	070	Line
HM21M...FOR	10	019	Top	K42M...V	25	044	Top	P2CCM...V	39	070	Line
HM21M...FOR-CT	10	019	Top	K42MJ...V	25	044	Top	P2SCM...	37	068	Line
HM2CCM...FORY-CT	42	078	Top	K43M...CT	25	044	Top	P2SCM...FP	39	072	Line
HM2SCM...FOR-T	42	078	Top	K43M...V	25	044	Top	P2SCM...FP-T	40	072	Line
HM-XT20M...CT	10	019	Top	K43MJ...V	25	044	Top	P2SCM...LH	40	073	Line
K20M...TXC	9	017	Top	K52M...CT	19	034	Top	P2SCM...LH-T	40	073	Line
K21M...TXC	9	017	Top	K52M...NI	20	035	Top	P2SCM...SP	37	068	Line
K22M...FOR-TXC	9	017	Top	K52M...NI-4HX	20	035	Top	P2SCM...SP-T	38	068	Line
K22M...FORY-TXC	9	017	Top	K52M...NI-CT	20	035	Top	P2SCM...SP-V	38	068	Line
K23M...FOR-TXC	9	017	Top	K52M...V	19	034	Top	P2SCM...T	38	068	Line
K23M...FORY-TXC	9	017	Top	K52MJ...V	19	034	Top	P2SCM...V	38	068	Line
K24M...FORY-TXC	18	031	Top	K52MJ...CT	19	034	Top	P3CCM...	39	071	Line
K24M...XFORY-TXC	18	032	Top	K53M...CT	19	034	Top	P3CCM...SP	39	071	Line
K24M...X-TXC	18	032	Top	K53M...V	19	034	Top	P3CCM...SP-T	39	071	Line
K24M...FORY-XP	17	029	Top	K53MJ...V	19	034	Top	P3CCM...SP-V	39	071	Line
K24M...TXC	17	031	Top	K53MJ...CT	19	034	Top	P3CCM...T	39	071	Line
K24M...XP	17	029	Top	K80M...FOR-TXC	36	063	Top	P3CCM...V	39	071	Line
K25M...FORY-TXC	18	031	Top	K80M...TXC	36	063	Top	P3SCM...	38	069	Line
K25M...XFORY-TXC	18	032	Top	K81M...FOR-TXC	36	063	Top	P3SCM...SP	38	069	Line
K25M...X-TXC	18	032	Top	K81M...TXC	36	063	Top	P3SCM...SP-T	38	069	Line
K25M...FORY-XP	17	029	Top	K82M...FOR-XP	35	060	Top	P3SCM...SP-V	38	069	Line
K25M...TXC	17	031	Top	K82M...FORY-XP	35	060	Top	P3SCM...T	38	069	Line
K25M...XP	17	029	Top	K82M...XFORY-TXC	37	065	Top	P3SCM...V	38	069	Line
K26EM...FOR-TX	8	015	Top	K82M...XP	35	060	Top	P40M...	24	042	Plus
K26EM...FORY-TX	9	015	Top	K82M...X-TXC	37	065	Top	P40M...CT	24	042	Plus
K26EM...TX	8	015	Top	K83M...FOR-XP	35	060	Top	P40M...T	24	042	Plus
K26M...FOR-TX	8	014	Top	K83M...FORY-XP	35	060	Top	P40M...V	24	042	Plus
				K83M...XFORY-TXC	37	065	Top	P41M...	24	042	Plus
				K83M...XP	35	060	Top	P41M...CT	24	042	Plus
								P41M...T	24	042	Plus
								P41M...V	24	042	Plus

INDICE PRODOTTI

PRODUCTS INDEX

INDEX DES PRODUITS

Filettatura-Thread-Filetage				Filettatura-Thread-Filetage				Filettatura-Thread-Filetage			
M				MF				MF			
CODICE - code	pg. list.	pg. cat.	Typ.	CODICE - code	pg. list.	pg. cat.	Typ.	CODICE - code	pg. list.	pg. cat.	Typ.
P60EM...	33	057	Plus	00MF...	43-44	082-084	Line	E60MF...V	59	122	Line
P60EM...FOR	33	057	Plus	00MF...LH	44	085	Line	E61MF...	60-61	123-126	Line
P60EM...FOR-XP	33	057	Plus	01MF...	43-44	082-084	Line	E61MF...+0,1	63	129	Line
P60EM...XP	33	057	Plus	01MF...LH	44	085	Line	E61MF...-4H	63	129	Line
P60M...	32	056	Plus	03MF...	43-44	082-084	Line	E61MF...-6G	63	129	Line
P60M...T	32	056	Plus	03MF...LH	44	085	Line	E61MF...-7G	63	129	Line
P60M...V	32	056	Plus	E20MF...	45	086	Line	E61MF...FOR	62	127	Line
P60M...XP	32	056	Plus	E20MF...T	45	086	Line	E61MF...FOR-T	62	127	Line
P61EM...	33	057	Plus	E21MF...	45-46	087-092	Line	E61MF...FOR-TXC	62	127	Line
P61EM...FOR	33	057	Plus	E21MF...LH	46	093	Line	E61MF...LH	63	128	Line
P61EM...FOR-XP	33	057	Plus	E21MF...LH-T	46	093	Line	E61MF...LH-V	63	128	Line
P61EM...XP	33	057	Plus	E21MF...T	46	087-088	Line	E61MF...LH-XP	63	128	Line
P61M...	32	056	Plus	E24MF...	49	100	Line	E61MF...NC	64	130	Line
P61M...T	32	056	Plus	E24MF...T	49	100	Line	E61MF...T	60-61	123-126	Line
P61M...V	32	056	Plus	E24MF...TXC	49	100	Line	E61MF...TXC	62	123-126	Line
P61M...XP	32	056	Plus	E24MF...V	49	100	Line	E61MF...V	60-61	123-126	Line
S20M...FOR-TXC	9	016	Top	E24MF...LH	52	104	Line	E71MF...	63	130	Line
S20M...FORY-TXC	9	016	Top	E24MF...LH-T	52	104	Line	E71MF...VS	63	130	Line
S20M...TXC	9	016	Top	E25MF...AL	52	106	Line	E81MF...	64	132	Line
S24M...FORY-TXC	17	030	Top	E25MF...AL-VS	52	106	Line	E81MF...T	64	132	Line
S24M...TXC	17	030	Top	E25MF...	50	101-103	Line	E81MF...V	64	132	Line
S80M...FOR-TXC	35	061	Top	E25MF...+0,1	52	105	Line	E81MF...XP	64	132	Line
S80M...TXC	35	061	Top	E25MF...-4H	52	105	Line	E83MF...	65	133	Line
V24M...TXC	18	032	Top	E25MF...-6G	52	105	Line	E83MF...T	65	133	Line
V25M...TXC	18	032	Top	E25MF...-7G	52	105	Line	E83MF...V	65	133	Line
V82M...TXC	37	064	Top	E25MF...LH	52	104	Line	E83MF...XP	65	133	Line
V83M...TXC	37	064	Top	E25MF...LH-T	52	104	Line	HM20MF...FOR	49	099	Top
X2CCEM...FOR-TG	42	077	Top	E25MF...NC	52	106	Plus	HM21MF...FOR	49	099	Top
X2CCEM...TG	42	077	Top	E25MF...T	51	101-103	Line	K21MF...TXC	48	099	Top
X2CCM...CT	41	075	Top	E25MF...V	50	101-103	Line	K23MF...FOR-TXC	49	099	Top
X2CCM...FOR-TG	42	076	Top	E25MF...TXC	51	101-103	Line	K23MF...FORY-TXC	49	099	Top
X2CCM...FORY-TG	42	076	Top	E25MF...X-V	54	111	Top	K25MF...FORY-TXC	54	110	Top
X2CCM...NC	41	075	Top	E26MF...FOR-CT	46	094	Line	K25MF...FORY-XP	54	108	Top
X2CCM...SP-CT	41	075	Top	E26MF...NQ	46	094	Line	K25MF...TXC	54	110	Top
X2CCM...SP-NC	41	075	Top	E26MF...SP-NQ	46	094	Line	K25MF...XFORY-TXC	55	111	Top
X2CCM...SP-TG	41	075	Top	E27MF...FOR-CT	47	095	Line	K25MF...XP	53	108	Top
X2CCM...TG	41	075	Top	E27MF...NQ	47	095	Line	K25MF...X-TXC	55	111	Top
X2CCM...TXC	42	076	Top	E26MF...CT	46	094	Line	K27EMF...TX	48	097	Top
X2SCEM...TG	42	077	Top	E26MF...SP-CT	46	094	Line	K27EMF...FOR-TX	48	097	Top
X2SCM...CT	41	074	Top	E27MF...CT	46	095	Line	K27EMF...FORY-TX	48	097	Top
X2SCM...NC	40	074	Top	E27MF...SP-CT	46	095	Line	K27MF...TX	47	096	Top
X2SCM...SP-CT	41	074	Top	E40MF...	56	115	Line	K27MF...TXS	47	096	Top
X2SCM...SP-NC	40	074	Top	E40MF...FOR	58	118	Line	K27MF...FOR-TX	48	096	Top
X2SCM...SP-TG	40	074	Top	E40MF...FOR-T	58	118	Line	K27MF...FORY-TX	48	096	Top
X2SCM...TG	40	074	Top	E40MF...T	56	115	Line	K42MF...CT	59	120	Top
X3CCM...SP-TG	41	075	Top	E40MF...V	56	115	Line	K42MF...NI	59	121	Top
X3CCM...TG	41	075	Top	E40MF...XP	56	115	Line	K42MF...NI-4HX	59	121	Top
X3SCM...SP-TG	41	074	Top	E41MF...	57	116-117	Line	K42MF...NI-CT	59	121	Top
X3SCM...TG	41	074	Top	E41MF...FOR	58	118	Line	K42MF...V	59	120	Top
XT20M...	10	018	Top	E41MF...FOR-T	58	118	Line	K42MJF...V	59	120	Top
XT20M...TX	10	018	Top	E41MF...T	57	116-117	Line	K43MF...CT	59	120	Top
XT21M...	10	018	Top	E41MF...V	57	116-117	Line	K43MF...V	59	120	Top
				E41MF...XP	58	116-117	Line	K43MJF...V	59	120	Top
				E51MF...	55	112	Line	K52MF...CT	56	113	Top
				E51MF...V	55	112	Line	K52MF...NI	56	114	Top
				E51MF...XP	55	112	Line	K52MF...NI-4HX	56	114	Top
				E60MF...	59	122	Line	K52MF...NI-CT	56	114	Top
				E60MF...FOR	62	127	Line	K52MF...V	55	113	Top
				E60MF...FOR-T	62	127	Line	K52MJF...V	56	113	Top
				E60MF...FOR-TXC	62	127	Line				
				E60MF...T	59	122	Line				
				E60MF...TXC	60	122	Line				

INDICE PRODOTTI

PRODUCTS INDEX

INDEX DES PRODUITS

Filettatura-Thread-Filetage				MF				Filettatura-Thread-Filetage				MF				Filettatura-Thread-Filetage				UNC											
CODICE - code	pg. list.	pg. cat.	Typ.	CODICE - code	pg. list.	pg. cat.	Typ.	CODICE - code	pg. list.	pg. cat.	Typ.	CODICE - code	pg. list.	pg. cat.	Typ.	CODICE - code	pg. list.	pg. cat.	Typ.	CODICE - code	pg. list.	pg. cat.	Typ.	CODICE - code	pg. list.	pg. cat.	Typ.	CODICE - code	pg. list.	pg. cat.	Typ.
K53MF...CT	56	113	Top	S24MF...TXX	54	109	Top	K24UNC...XP	75	154	Top	01UNC...	72	150	Line	00UNF...	81	166	Line												
K53MF...V	55	113	Top	S80MF...TXX	65	135	Top	K25UNC...FORY-XP	75	154	Top	02UNC...	72	150	Line	01UNF...	81	166	Line												
K53MJF...V	56	113	Top	S80MF...FOR-TXX	66	135	Top	K25UNC...XP	75	154	Top	03UNC...	72	150	Line	03UNF...	81	166	Line												
K81MF...FOR-TXX	66	136	Top	V25MF...TXX	54	111	Top	K26UNC...FOR-TX	73	152	Top	00UNC...	72	150	Line	E20UNF...	82	167	Line												
K81MF...TXX	66	136	Top	V83MF...TXX	66	137	Top	K26UNC...TX	73	152	Top	E20UNC...	72	151	Line	E20UNF...T	82	167	Line												
K83MF...FOR-XP	65	134	Top	X2CCEMF...FOR-TG	71	146	Top	K27UNC...FOR-TX	73	152	Top	E21UNC...	72	151	Line	E21UNF...	82	167	Line												
K83MF...FORY-XP	65	134	Top	X2CCMF...TG	71	146	Top	K27UNC...TX	73	152	Top	E21UNC...T	73	151	Line	E21UNF...T	82	167	Line												
K83MF...X-FOR-TXX	66	137	Top	X2CCMF...FOR-TG	70	145	Top	K42UNC...CT	77	158	Top	E24UNC...	74	153	Line	E24UNF...	83	169	Line												
K83MF...XP	65	134	Top	X2CCMF...FORY-TG	70	145	Top	K42UNC...V	77	158	Top	E24UNC...T	74	153	Line	E24UNF...T	83	169	Line												
K83MF...X-TXX	66	137	Top	X2CCMF...TG	70	144	Top	K43UNC...CT	77	158	Top	E24UNC...V	74	153	Line	E24UNF...T	83	169	Line												
P25MF...	53	107	Plus	X2CCMF...TXX	70	145	Top	K43UNC...V	77	158	Top	E24UNC...XP	74	153	Line	E24UNF...V	83	169	Line												
P25MF...CT	53	107	Plus	X2SCEMF...TG	71	146	Top	K43UNC...V	77	158	Top	E25UNC...	74	153	Line	E24UNF...XP	83	169	Line												
P25MF...T	53	107	Plus	X2SCMF...TG	70	144	Top	K43UNC...V-3BX	77	158	Top	E25UNC...T	74	153	Line	E25UNF...	83	169	Line												
P25MF...V	53	107	Plus	X3CCMF...TG	70	144	Top	K52UNC...CT	75	156	Top	E25UNC...V	74	153	Line	E25UNF...T	83	169	Line												
P2CCMF...	68	140	Line	X3SCMF...TG	70	144	Top	K52UNC...V	75	156	Top	E25UNC...XP	74	153	Line	E25UNF...V	83	169	Line												
P2CCMF...FP	69	142	Line					K52UNC...V-3BX	76	156	Top	E26UNC...NQ	73	152	Line	E25UNF...XP	83	169	Line												
P2CCMF...FP-T	69	142	Line					K53UNC...CT	75	156	Top	E26UNC...SP-NQ	73	152	Line	E26UNF...	83	169	Line												
P2CCMF...LH	69	143	Line					K53UNC...V	75	156	Top	E27UNC...NQ	73	152	Line	E26UNF...T	82	167	Line												
P2CCMF...LH-T	69	143	Line					K53UNC...V-3BX	76	156	Top	E26UNC...CT	73	152	Line	E26UNF...T	82	167	Line												
P2CCMF...SP	68	140	Line					K82UNC...FOR-XP	79	160	Top	E26UNC...CT-SP	73	152	Line	E26UNF...T	82	167	Line												
P2CCMF...SP-T	68	140	Line					K82UNC...FORY-XP	79	160	Top	E27UNC...CT	73	152	Line	E26UNF...T	82	167	Line												
P2CCMF...SP-V	68	140	Line					K82UNC...XP	79	160	Top	E40UNC...	76	157	Line	E26UNF...T	82	167	Line												
P2CCMF...T	68	140	Line					K83UNC...FOR-XP	79	160	Top	E40UNC...T	76	157	Line	E26UNF...T	82	167	Line												
P2CCMF...V	68	140	Line					K83UNC...FORY-XP	79	160	Top	E40UNC...V	76	157	Line	E26UNF...T	82	167	Line												
P2SCMF...	66	138	Line					K83UNC...XP	79	160	Top	E40UNC...XP	77	157	Line	E26UNF...T	82	167	Line												
P2SCMF...FP	69	142	Line					P2CCUNC...	80	162	Line	E41UNC...	76	157	Line	E26UNF...T	82	167	Line												
P2SCMF...FP-T	69	142	Line					P2CCUNC...T	80	162	Line	E41UNC...T	76	157	Line	E26UNF...T	82	167	Line												
P2SCMF...LH	69	143	Line					P2SCUNC...	79	162	Top	E41UNC...T	76	157	Line	E26UNF...T	82	167	Line												
P2SCMF...LH-T	69	143	Line					P2SCUNC...T	79	162	Top	E41UNC...V	76	157	Line	E26UNF...T	82	167	Line												
P2SCMF...SP	66	138	Line					V24UNC...TXX	75	155	Top	E41UNC...XP	77	157	Line	E26UNF...T	82	167	Line												
P2SCMF...SP-T	67	138	Line					V25UNC...TXX	75	155	Top	E41UNC...V	76	157	Line	E26UNF...T	82	167	Line												
P2SCMF...SP-V	67	138	Line					V82UNC...TXX	79	161	Top	E41UNC...XP	77	157	Line	E26UNF...T	82	167	Line												
P2SCMF...T	67	138	Line					V83UNC...TXX	79	161	Top	E60UNC...	77	159	Line	E26UNF...T	82	167	Line												
P2SCMF...V	67	138	Line								E60UNC...T	78	159	Line	E26UNF...T	82	167	Line													
P3CCMF...	68	141	Line								E60UNC...V	78	159	Line	E26UNF...T	82	167	Line													
P3CCMF...SP	68	141	Line								E60UNC...XP	78	159	Line	E26UNF...T	82	167	Line													
P3CCMF...SP-T	68	141	Line								E61UNC...	77	159	Line	E26UNF...T	82	167	Line													
P3CCMF...SP-V	68	141	Line								E61UNC...T	78	159	Line	E26UNF...T	82	167	Line													
P3CCMF...T	68	141	Line								E61UNC...V	78	159	Line	E26UNF...T	82	167	Line													
P3SCMF...	67	139	Line								E61UNC...XP	78	159	Line	E26UNF...T	82	167	Line													
P3SCMF...SP	67	139	Line								K24UNC...FORY-XP	75	154	Top	E26UNF...T	82	167	Line													
P3SCMF...SP-T	67	139	Line											E26UNF...T	82	167	Line														
P3SCMF...SP-V	67	139	Line											E26UNF...T	82	167	Line														
P3SCMF...-T	67	139	Line											E26UNF...T	82	167	Line														
P3SCMF...V	67	139	Line											E26UNF...T	82	167	Line														
P41MF...	58	119	Plus											E26UNF...T	82	167	Line														
P41MF...CT	58	119	Plus											E26UNF...T	82	167	Line														
P41MF...T	58	119	Plus											E26UNF...T	82	167	Line														
P41MF...V	58	119	Plus											E26UNF...T	82	167	Line														
P61MF...	64	131	Plus											E26UNF...T	82	167	Line														
P61MF...T	64	131	Plus											E26UNF...T	82	167	Line														
P61MF...V	64	131	Plus											E26UNF...T	82	167	Line														
P61MF...XP	64	131	Plus											E26UNF...T	82	167	Line														
S20MF...FOR-TXX	48	098	Top											E26UNF...T	82	167	Line														
S20MF...FORY-TXX	48	098	Top											E26UNF...T	82	167	Line														
S20MF...TXX	48	098	Top											E26UNF...T	82	167	Line														
S24MF...FORY-TXX	54	109	Top											E26UNF...T	82	167	Line														

INDICE PRODOTTI

PRODUCTS INDEX

INDEX DES PRODUITS

Segue - Follow - Suite	UNF		
CODICE - code	pg. list.	pg. cat.	Typ.
E40UNF...	85	173	Line
E40UNF...T	85	173	Line
E40UNF...V	85	173	Line
E40UNF...XP	85	173	Line
E41UNF...	85	173	Line
E41UNF...T	85	173	Line
E41UNF...V	85	173	Line
E41UNF...XP	85	173	Line
E60UNF...	86	175	Line
E60UNF...T	86	175	Line
E60UNF...V	86	175	Line
E60UNF...XP	87	175	Line
E61UNF...	86	175	Line
E61UNF...T	86	175	Line
E61UNF...V	86	175	Line
E61UNF...XP	87	175	Line
K24UNF...FORY-XP	84	170	Top
K24UNF...XP	84	170	Top
K25UNF...FORY-XP	84	170	Top
K25UNF...XP	84	170	Top
K27UNF...FOR-TX	83	168	Top
K27UNF...TX	82	168	Top
K42UNF...CT	86	174	Top
K42UNF...V	86	174	Top
K42UNF...V-3BX	86	174	Top
K43UNF...CT	86	174	Top
K43UNF...V	86	174	Top
K43UNF...V-3BX	86	174	Top
K52UNF...CT	84	172	Top
K52UNF...V	84	172	Top
K52UNF...V-3BX	85	172	Top
K53UNF...CT	84	172	Top
K53UNF...V	84	172	Top
K53UNF...V-3BX	85	172	Top
K82UNF...FOR-XP	87	176	Top
K82UNF...FORY-XP	87	176	Top
K82UNF...XP	87	176	Top
K83UNF...FOR-XP	87	176	Top
K83UNF...FORY-XP	87	176	Top
K83UNF...XP	87	176	Top
P2CCUNF...	88	178	Line
P2CCUNF...T	88	178	Line
P2SCUNF...	88	178	Line
P2SCUNF...T	88	178	Line
V24UNF...TXC	84	171	Top
V25UNF...TXC	84	171	Top
V82UNF...TXC	88	177	Top
V83UNF...TXC	88	177	Top

Filettatura-Thread-Filetage	UNEF		
CODICE - code	pg. list.	pg. cat.	Typ.
E21UNEF...	89	182	Line
E21UNEF...T	89	182	Line
E25UNEF...	89	183	Line
E25UNEF...T	89	183	Line
E61UNEF...	89	184	Line
E61UNEF...XP	89	184	Line

Filettatura-Thread-Filetage	UNS		
CODICE - code	pg. list.	pg. cat.	Typ.
E20...UNS...	90	185	Line
E20...UNS...T	90	185	Line
E21...UNS...	90	185	Line
E21...UNS...T	90	185	Line

Filettatura-Thread-Filetage	UN		
CODICE - code	pg. list.	pg. cat.	Typ.
E21-12UN...	91	186	Line
E21-16UN...	91	186	Line
E21-20UN...	91	187	Line
E21-20UN...T	91	187	Line
E21-28UN...	91	187	Line
E21-28UN...T	91	187	Line
E21-32UN...	91	187	Line
E21-32UN...T	91	187	Line
E21-8UN...	91	186	Line
E41-8UN...	91	186	Line
E81-8UN...	91	186	Line

Filettatura-Thread-Filetage	GAS		
CODICE - code	pg. list.	pg. cat.	Typ.
00G...	92	190	Line
01G...	92	190	Line
03G...	92	190	Line
E21G...	93	191	Line
E21G...T	93	191	Line
E25G...	93	193	Line
E25G...T	94	193	Line
E25G...V	93	193	Line
E25G...XP	94	193	Line
E27G...NQ	93	192	Line
E27G...CT	93	192	Line
E41G...	94	197	Line
E41G...+0,05	95	197	Line
E41G...T	95	197	Line
E41G...V	95	197	Line
E61G...	95	198	Line
E61G...T	95	198	Line
E61G...V	95	198	Line
E61G...XP	95	198	Line
K25G...FORY-XP	94	194	Top
K25G...XP	94	194	Top
K27G...FOR-TX	93	192	Top

Segue - Follow - Suite	GAS		
CODICE - code	pg. list.	pg. cat.	Typ.
K27G...TX	93	192	Top
K83G...FOR-XP	96	199	Top
K83G...FORY-XP	96	199	Top
K83G...XP	96	199	Top
P2CCG...	96	202	Line
P2CCG...T	96	202	Line
S24G...FORY-TXC	94	195	Top
S24G...TXC	94	195	Top
S80G...FOR-TXC	96	200	Top
S80G...TXC	96	200	Top
V25G...TXC	94	196	Top
V83G...TXC	96	201	Top
X2CCG...FOR-TG	96	202	Top
X2CCG...TG	96	202	Top

Filettatura-Thread-Filetage	Rp		
CODICE - code	pg. list.	pg. cat.	Typ.
E21RP...	97	204	Line
E21RP...T	97	204	Line

Filettatura-Thread-Filetage	NPSM		
CODICE - code	pg. list.	pg. cat.	Typ.
E21NPSM...	97	206	Line
E21NPSM...T	97	206	Line

Filettatura-Thread-Filetage	NPSF		
CODICE - code	pg. list.	pg. cat.	Typ.
E21NPSF...	97	207	Line
E21NPSF...T	97	207	Line

Filettatura-Thread-Filetage	Rc		
CODICE - code	pg. list.	pg. cat.	Typ.
E21CRC...	97	210	Line
E41CRC...V	97	210	Line
E21LRC...	98	210	Line
E21LRC...TXC	98	210	Line

Filettatura-Thread-Filetage	NPT		
CODICE - code	pg. list.	pg. cat.	Typ.
E21CNPT...	98	212	Line
E21CNPT...AZ	98	213	Line
E41CNPT...V	98	212	Line
E21LNPT...	98	212	Line
E21LNPT...AZ	99	213	Line
E21LNPT...TXC	98	212	Line

INDICE PRODOTTI

PRODUCTS INDEX

INDEX DES PRODUITS

Filettatura-Thread-Filetage		NPTF	
CODICE - code	pg. list.	pg. cat.	Typ.
E21CNPTF...	99	214	Line
E41CNPTF...V	99	214	Line
E21LNPTF...	99	214	Line
E21LNPTF...TXC	99	214	Line

Filettatura-Thread-Filetage		BSW	
CODICE - code	pg. list.	pg. cat.	Typ.
00W...	100	218	Line
01W...	100	218	Line
02W...	100	218	Line
03W...	100	218	Line
E20W...	101	219	Line
E20W...T	101	219	Line
E21W...	101	219	Line
E21W...T	101	219	Line
E24W...	101	220	Line
E24W...T	101	220	Line
E24W...V	101	220	Line
E24W...XP	102	220	Line
E25W...	101	220	Line
E25W...T	101	220	Line
E25W...V	101	220	Line
E25W...XP	102	220	Line
E60W...	102	221	Line
E60W...T	102	221	Line
E60W...V	102	221	Line
E60W...XP	102	221	Line
E61W...	102	221	Line
E61W...T	102	221	Line
E61W...V	102	221	Line
E61W...XP	102	221	Line

Filettatura-Thread-Filetage		ISO 529-EGM	
CODICE - code	pg. list.	pg. cat.	Typ.
529E18M...	104	227	Line
529E18M...T	104	227	Line
529E24M...	104	227	Line
529E24M...T	104	227	Line
529E26M...CT	104	226	Line
529E60M...	105	228	Line
529E60M...XP	105	228	Line
529E80M...	105	228	Line
529E80M...XP	105	228	Top
529K26M...TXC	104	226	Top
E20EGM...	105	230	Line
E20EGM...T	105	230	Line
E21EGM...	105	230	Line
E21EGM...T	105	230	Line
E24EGM...	106	231	Line
E24EGM...XP	106	231	Line
E25EGM...	106	231	Top
E25EGM...XP	106	231	Line
E60EGM...	106	232	Line
E60EGM...XP	106	232	Line
E61EGM...	106	232	Line
E61EGM...XP	106	232	Line

Filettatura-Thread-Filetage		EPF	
CODICE - code	pg. list.	pg. cat.	Typ.
EPFALUM...	107	234	Line
EPFALUM...VS	107	234	Line
EPFM...	107	234	Line
EPFM...VS	107	234	Line
EPFMF...	107	234	Line
EPFMF...VS	107	234	Line

Filettatura-Thread-Filetage		PG	
CODICE - code	pg. list.	pg. cat.	Typ.
E21PG...	103	222	Line
E21PG...T	103	222	Line
E25PG...	103	222	Line
E25PG...T	103	222	Line

Filettatura-Thread-Filetage		Tr (TPN)	
CODICE - code	pg. list.	pg. cat.	Typ.
E21TPN...	103	223	Line
E21TPN...V	103	223	Line
E21TPN...LH	103	223	Line
E21TPN...LH-V	103	223	Line

Filettatura-Thread-Filetage		Rd	
CODICE - code	pg. list.	pg. cat.	Typ.
E21RD...	104	224	Line
E21RD...T	104	224	Line

Filettatura-Thread-Filetage		DIES	
CODICE - code	pg. list.	pg. cat.	Typ.
100-99M...	111	236	Line
100E99XM...	111	236	Line
100S99M...	111	236	Line
110-99M...	112	237-239	Line
110E99XM...	113	237-238	Line
110S99M...	113	237-238	Line
200-99W...	116	245	Line
300-99U...	114	240	Line
300-S99U...	114	240	Line
310-99U...	114	241	Line
310S99U...	114	241	Line
400-99G...	115	242	Line
400-E99XG...	115	242	Line
400S99G...	115	242	Line
410-99RC...	115	243	Line
420-99NPT...	115	244	Line
430-99NPTF...	115	244	Line
700-99PG...	116	246	Line

Filettatura-Thread-Filetage		GO / NO-GO	
CODICE - code	pg. list.	pg. cat.	Typ.
P-NPG...	110	203	Line
P-NPM...	108	79	Line
P-NPMF...	108	147-148	Line
P-NPNPT...	110	215	Line
P-NPNPTF...	110	215	Line
P-NPRC...	110	211	Line
P-NPUNC...	109	163	Line
P-NPUNEF...	109	188	Line
P-NPUNF...	109	179	Line

NEWS

K-ROLL

E94



E92





Running to the Top

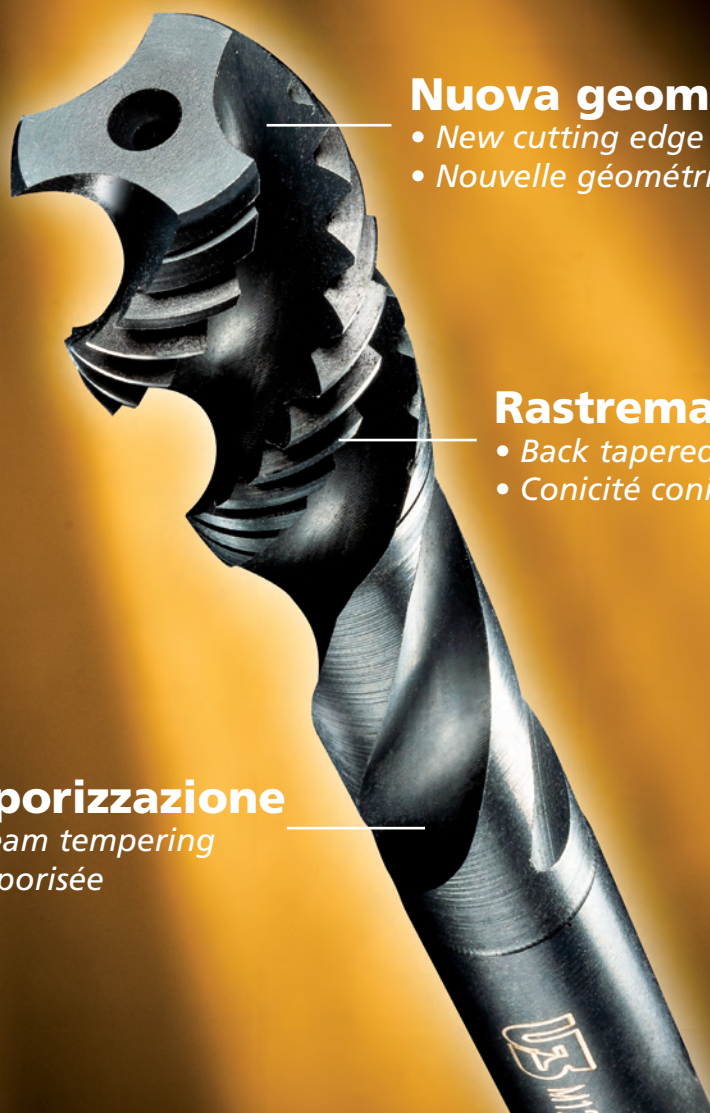

Nuova geometria di taglio

- *New cutting edge geometry*
- *Nouvelle géométrie de coupe*

Rastremazione posteriore

- *Back tapered*
- *Conicité conique arrière*

Vaporizzazione

- *Steam tempering*
- *Vaporisée*

Nuovi maschi a macchina in HSSE, per filettatura cieca, profonda fino a 3xD

New machine taps HSSE steel, for deep threading until 3XD

Tarauts nouveaux en HSSE pour filetage dans les trous borgnes jusqu'à 3xD

Caratteristiche

Features - Caractéristiques

Acciai 1.1 - 1.2 - 1.3 - 1.4 - 2.1 - 2.2

Steels - Aciers

Nuova geometria di elica

New helix geometry - Nouvelle géométrie hélice

Cura del cutting edge che stabilizza il prodotto

New cutting edge for better performance

Nouveau tranchant pour de meilleures performances

Rastremazione posteriore

Back tapered - Conicité arrière

Utilizzo sia in maschiatura rigida che compensata

Standard and rigid tapping - Taraudage normal et rigide

Grandi vantaggi

Big Advantages - Gros avantages

Favorita la fuoriuscita del truciolo, senza matassa

Excellent chip removal without sticking

Enlèvement de copeaux excessif, sans écheveau

Riduzione fermi macchina

Downtime reduction - Réduction des temps d'arrêt

Incremento durata dell'utensile

Increased tool's life

Augmentation de la durée de vie de l'outil

Miglior qualità di filetto ottenuto

Better thread surface quality

Meilleure qualité de filet obtenu



Filettatura metrica ISO passo grosso DIN 13

ISO Metric coarse thread DIN 13

Metrisches ISO-Regelgewinde DIN13 – Maschinengewindebohrer

Filetage métrique ISO DIN 13 – Tarauds machine

Rosca ISO métrica regular DIN13 – Machos de roscar a máquina



N

USO GENERALE

General purpose - Usage Général

MASCHI A MACCHINA

MACHINE TAPS - TARAUDS MACHINE

DIN 371

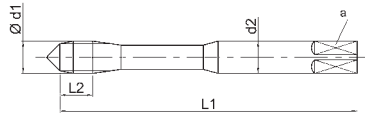

DIN 371

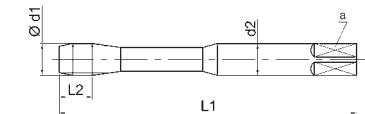

DIN 376

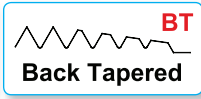
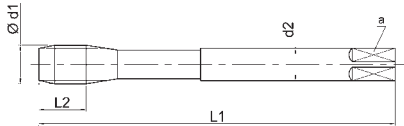

LINE



LINE



LINE



Profond. di filettatura - Thread depth - Profond. de filetage

Materiale - Material - Matériau

Tolleranza - Tolerance - Tolérance

Trattamento superficiale - Surface treatment - Revêtement

Numero gruppi materiali

Material's groups number

Nombre de groupes du matériau

3xD	3xD	3xD
HSSE	HSSE	HSSE
6HX	6HX	6HX
BR	V	TiN
1.1 1.2 1.3 1.4	1.1 1.2 1.3 1.4	1.1 1.2 1.3 1.4 1.5
4.2	2.1 2.2	4.3
5.1 5.2		5.2

DIN 371	Ød1 M	P mm	L1	L2	d2 h9	a h12	Z	
◀	3	0,5	56	5	3,5	2,7	3	2,5
◀	4	0,7	63	7	4,5	3,4	3	3,3
◀	5	0,8	70	8	6	4,9	3	4,2
◀	6	1	80	10	6	4,9	3	5
	8	1,25	90	13	8	6,2	3	6,8
	10	1,5	100	15	10	8	3	8,5

CODICE - CODE		
E92M...	E92M...V	E92M...T
E92M3	E92M3V	E92M3T
E92M4	E92M4V	E92M4T
E92M5	E92M5V	E92M5T
E92M6	E92M6V	E92M6T
E92M8	E92M8V	E92M8T
E92M10	E92M10V	E92M10T

DIN 376	Ød1 M	P mm	L1	L2	d2 h9	a h12	Z	
	12	1,75	110	18	9	7	3	10,3
	14	2	110	20	11	9	3	12
	16	2	110	20	12	9	4	14
	18	2,5	125	25	14	11	4	15,5
	20	2,5	140	25	16	12	4	17,5
	22	2,5	140	25	18	14,5	4	19,5
	24	3	160	30	18	14,5	4	21

CODICE - CODE		
E93M...	E93M...V	E93M...T
E93M12	E93M12V	E93M12T
E93M14	E93M14V	E93M14T
E93M16	E93M16V	E93M16T
E93M18	E93M18V	E93M18T
E93M20	E93M20V	E93M20T
E93M22	E93M22V	E93M22T
E93M24	E93M24V	E93M24T

Confezione / Box / Colis:
M3 – M10: 10 pezzi / pcs
M12 – M16: 5 pezzi / pcs

MASCHI A MACCHINA

MACHINE TAPS - TARAUDS MACHINE

DIN 371

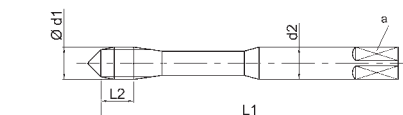

DIN 371

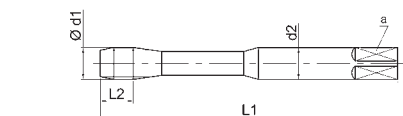

DIN 376

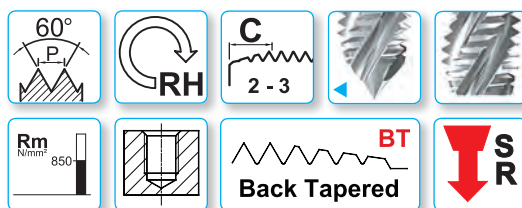
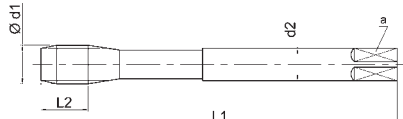

LINE



BT

R45°

LINE



BT

R45°

LINE



BT

R45°

Profond. di filettatura - Thread depth - Profond. de filetage

Materiale - Material - Matériau

Tolleranza - Tolerance - Tolérance

Trattamento superficiale - Surface treatment - Revêtement

Numero gruppi materiali

Material's groups number

Nombre de groupes du matériau

3xD	3xD	3xD
HSSE	HSSE	HSSE
6HX	6HX	6HX
TiN	TXC	TiN
1.1 1.2 1.3 1.4 1.5	1.1 1.2 1.3 1.4 1.5	1.1 1.2 1.3 1.4 1.5
4.3	2.1 2.2 2.3	4.3
5.2		5.2

DIN 371	Ød1 M	P mm	L1	L2	d2 h9	a h12	Z	
3	0,5	56	5	3,5	2,7	3	2,5	
4	0,7	63	7	4,5	3,4	3	3,3	
5	0,8	70	8	6	4,9	3	4,2	
6	1	80	10	6	4,9	3	5	
8	1,25	90	13	8	6,2	3	6,8	
10	1,5	100	15	10	8	3	8,5	

CODICE - CODE		
E94M...T	E94M...TXC	E94M...FOR-T
E94M3T	E94M3TXC	-
E94M4T	E94M4TXC	-
E94M5T	E94M5TXC	-
E94M6T	E94M6TXC	E94M6FOR-T
E94M8T	E94M8TXC	E94M8FOR-T
E94M10T	E94M10TXC	E94M10FOR-T

DIN 376	Ød1 M	P mm	L1	L2	d2 h9	a h12	Z	
12	1,75	110	18	9	7	3	10,3	
14	2	110	20	11	9	3	12	
16	2	110	20	12	9	4	14	
18	2,5	125	25	14	11	4	15,5	
20	2,5	140	25	16	12	4	17,5	
22	2,5	140	25	18	14,5	4	19,5	
24	3	160	30	18	14,5	4	21	

CODICE - CODE		
E95M...T	E95M...TXC	E95M...FOR-T
E95M12T	E95M12TXC	E95M12FOR-T
E95M14T	E95M14TXC	E95M14FOR-T
E95M16T	E95M16TXC	E95M16FOR-T
E95M18T	E95M18TXC	E95M18FOR-T
E95M20T	E95M20TXC	E95M20FOR-T
E95M22T	E95M22TXC	E95M22FOR-T
E95M24T	E95M24TXC	E95M24FOR-T

Per filettatura rigida
Syncro rigid threading
Pour le taraudage rigide



Confezione / Box / Colis:
M3 - M10: 10 pezzi / pcs
M12 - M16: 5 pezzi / pcs

N **USO GENERALE**
General purpose - Usage Général

MASCHI A MACCHINA
MACHINE TAPS - TARAUDS MACHINE

DIN 371

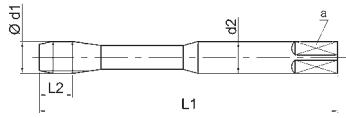

DIN 376

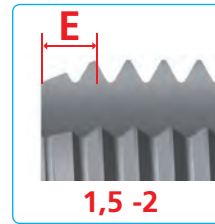
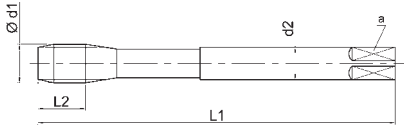

60° P
RH
E 1,5-2
Rm Nmm² 850
BT Back Tapered
SR

Profond. di filettatura - Thread depth - Profond. de filetage
Materiale - Material - Matériau
Tolleranza - Tolerance - Tolérance

3xD
HSSE
6HX
TXC

Numero gruppi materiali
Material's groups number
Nombre de groupes du matériau

1.1 1.2 1.3 1.4 1.5
2.1 2.2 2.3

DIN 371	Ød1 M	P mm	L1	L2	d2 h9	a h12	Z	
	3	0,5	56	5	3,5	2,7	3	2,5
	4	0,7	63	7	4,5	3,4	3	3,3
	5	0,8	70	8	6	4,9	3	4,2
	6	1	80	10	6	4,9	3	5
	8	1,25	90	13	8	6,2	3	6,8
	10	1,5	100	15	10	8	3	8,5

CODICE - CODE	
E94EM...TXC	
E94EM3TXC	
E94EM4TXC	
E94EM5TXC	
E94EM6TXC	
E94EM8TXC	
E94EM10TXC	

DIN 376	Ød1 M	P mm	L1	L2	d2 h9	a h12	Z	
	12	1,75	110	18	9	7	3	10,3
	14	2	110	20	11	9	3	12
	16	2	110	20	12	9	4	14

CODICE - CODE	
E95EM...TXC	
E95EM12TXC	
E95EM14TXC	
E95EM16TXC	

Per filettatura rigida
Synchro rigid threading
Pour le taraudage rigide

Confezione / Box / Colis:
M3 – M10: 10 pezzi / pcs
M12 – M16: 5 pezzi / pcs

MF Filettatura metrica ISO passo fine DIN 13

ISO metric fine thread DIN13
 Metrisches ISO-Feingewinde DIN 13 – Maschinengewindebohrer
 Filetage métrique ISO à pas fin DIN 13 – Tarauds machine
 Rosca ISO métrica fina DIN 13 – Machos de roscar a máquina



N

USO GENERALE
 General purpose - Usage Général

MASCHI A MACCHINA

MACHINE TAPS - TARAUDS MACHINE

DIN 374

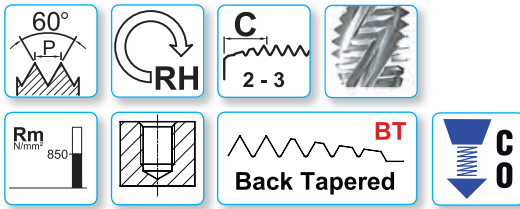
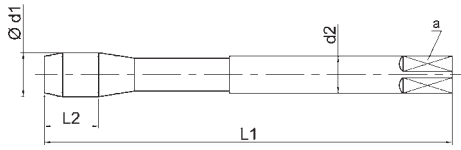

Profond. di filettatura - Thread depth - Profond. de filetage

Materiale - Material - Matériau

Tolleranza - Tolerance - Tolérance

Trattamento superficiale - Surface treatment - Revêtement

Numero gruppi materiali
 Material's groups number
 Nombre de groupes du matériau

3xD	3xD	3xD
HSSE	HSSE	HSSE
6HX	6HX	6HX
BR	V	TiN
1.1 1.2 1.3 1.4	1.1 1.2 1.3 1.4	1.1 1.2 1.3 1.4
4.2	2.1 2.2	4.3
5.1 5.2		5.2

DIN 374	Ød1 MF	P mm	L1	L2	d2 h9	a h12	Z	
	8	1	90	13	6	4,9	3	7
	10	1	90	15	7	5,5	3	9
	10	1,25	100	15	7	5,5	3	8,75
	12	1	100	13	9	7	3	11
	12	1,25	100	13	9	7	3	10,75
	12	1,5	100	13	9	7	3	10,5
	14	1,5	100	15	11	9	4	12,5
	16	1,5	100	15	12	9	4	14,5
	18	1,5	110	17	14	11	4	16,5
	20	1,5	125	17	16	12	4	18,5
new	22	1,5	125	18	18	14,5	4	20,5
new	24	1,5	140	20	18	14,5	4	22,5

CODICE - CODE		
E93MF...	E93MF...V	E93MF...T
E93MF8x1	E93MF8x1V	E93MF8x1T
E93MF10x1	E93MF10x1V	E93MF10x1T
E93MF10x1,25	E93MF10x1,25V	E93MF10x1,25T
E93MF12x1	E93MF12x1V	E93MF12x1T
E93MF12x1,25	E93MF12x1,25V	E93MF12x1,25T
E93MF12x1,5	E93MF12x1,5V	E93MF12x1,5T
E93MF14x1,5	E93MF14x1,5V	E93MF14x1,5T
E93MF16x1,5	E93MF16x1,5V	E93MF16x1,5T
E93MF18x1,5	E93MF18x1,5V	E93MF18x1,5T
E93MF20x1,5	E93MF20x1,5V	E93MF20x1,5T
E93MF22x1,5	E93MF22x1,5V	E93MF22x1,5T
E93MF24x1,5	E93MF24x1,5V	E93MF24x1,5T

Confezione / Box / Colis:
 M3 – M10: 10 pezzi / pcs
 M12 – M16: 5 pezzi / pcs

K-ROLL

MASCHI A RULLARE
 Roll form taps - Tarauds à refouler

MASCHI A MACCHINA

MACHINE TAPS - TARAUDS MACHINE

DIN 371

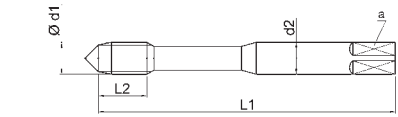

DIN 371

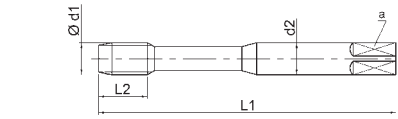

DIN 376

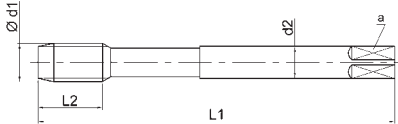

TOP



6HX

TOP



6GX



Profond. di filettatura - Thread depth - Profond. de filetage

Materiale - Material - Matériau

Tolleranza - Tolerance - Tolérance

Trattamento superficiale - Surface treatment - Revêtement

Numero gruppi materiali

Material's groups number

Nombre de groupes du matériau

3xD

3xD

PM8

PM8

6HX

6GX

TiN-G

TiN-G

1.3 1.4

1.5

1.3 1.4

1.5

2.2 2.3 2.4

2.2 2.3 2.4

DIN 371	Ød1 M	P mm	L ₁	L ₂	d ₂ h ₉	a h ₁₂	Z	
3	0,5	56	5	3,5	2,7	4	2,80	
4	0,7	63	7	4,5	3,4	4	3,70	
5	0,8	70	8	6	4,9	5	4,65	
6	1	80	10	6	4,9	5	5,55	
8	1,25	90	13	8	6,2	5	7,40	
10	1,5	100	15	10	8	8	9,30	

CODICE - CODE	
K2CCM...TG	K3CCM...TG
K2CCM3TG	K3CCM3TG
K2CCM4TG	K3CCM4TG
K2CCM5TG	K3CCM5TG
K2CCM6TG	K3CCM6TG
K2CCM8TG	K3CCM8TG
K2CCM10TG	K3CCM10TG

DIN 376	Ød1 M	P mm	L ₁	L ₂	d ₂ h ₉	a h ₁₂	Z	
12	1,75	110	18	9	7	8	11,20	
14	2	110	20	11	9	8	13,10	
16	2	110	20	12	9	8	15,10	

CODICE - CODE	
K2CCM...TG	K3CCM...TG
K2CCM12TG	K3CCM12TG
K2CCM14TG	K3CCM14TG
K2CCM16TG	K3CCM16TG

Confezione / Box / Colis:
 M3 – M10: 10 pezzi / pcs
 M12 – M16: 5 pezzi / pcs



Filettatura metrica ISO passo grosso DIN 13

ISO Metric coarse thread DIN 13

Metrisches ISO-Regelgewinde DIN13 – Maschinengewindebohrer

Filetage métrique ISO DIN 13 – Tarauds machine

Rosca ISO métrica regular DIN13 – Machos de roscar a máquina



K-ROLL

MASCHI A RULLARE
Roll form taps - Tarauds à refouler

MASCHI A MACCHINA

MACHINE TAPS - TARAUDS MACHINE

DIN 371

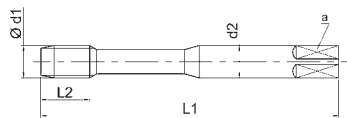

DIN 376

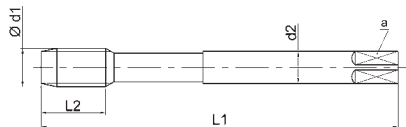

Profond. di filettatura - Thread depth - Profond. de filetage

Materiale - Material - Matériau

Tolleranza - Tolerance - Tolérance

Trattamento superficiale - Surface treatment - Revêtement

Numero gruppi materiali
Material's groups number
Nombre de groupes du matériau

TOP



3xD

PM8

6HX

TiN-G

1.3 1.4 1.5

2.2 2.3 2.4

TOP



3xD

PM8

6HX

TiN-G

1.3 1.4 1.5

2.2 2.3 2.4

DIN 371	Ød1 M	P mm	L1	L2	d2 h9	a h12	Z	
6	1	80	10	6	4,9	5	5,55	
8	1,25	90	13	8	6,2	5	7,40	
10	1,5	100	15	10	8	8	9,30	

CODICE - CODE	
K2CCM...FOR-TG	K2CCM...FORY-TG
K2CCM6FOR-TG	K2CCM6FORY-TG
K2CCM8FOR-TG	K2CCM8FORY-TG
K2CCM10FOR-TG	K2CCM10FORY-TG

DIN 376	Ød1 M	P mm	L1	L2	d2 h9	a h12	Z	
12	1,75	110	18	9	7	8	11,20	
14	2	110	20	11	9	8	13,10	
16	2	110	20	12	9	8	15,10	

CODICE - CODE	
K2CCM...FOR-TG	K2CCM...FORY-TG
K2CCM12FOR-TG	K2CCM12FORY-TG
K2CCM14FOR-TG	K2CCM14FORY-TG
K2CCM16FOR-TG	K2CCM16FORY-TG

Confezione / Box / Colis:
M3 - M10: 10 pezzi / pcs
M12 - M16: 5 pezzi / pcs

K-ROLL

MASCHI A RULLARE

Roll form taps - Tarauds à refouler

MASCHI A MACCHINA

MACHINE TAPS - TARAUDS MACHINE

DIN 371

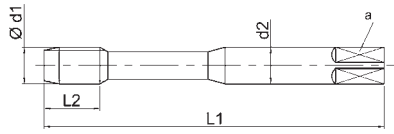

TOP



TOP

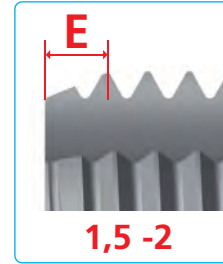

60° P RH E 1,5 - 2 CNC

Rm Nimet 1200 L Z

Profond. di filettatura - Thread depth - Profond. de filetage

Materiale - Material - Matériau

Tolleranza - Tolerance - Tolérance

Trattamento superficiale - Surface treatment - Revêtement

Numero gruppi materiali

Material's groups number

Nombre de groupes du matériau

3xD

PM8

6HX

TiN-G

1.3 1.4

1.5

2.2 2.3 2.4

3xD

PM8

6HX

TiN-G

1.3 1.4

1.5

2.2 2.3 2.4

DIN 371	Ød1 M	P mm	L1	L2	d2 h9	a h12	Z	
6	1	80	10	6	4,9	5	5,55	
8	1,25	90	13	8	6,2	5	7,40	
10	1,5	100	15	10	8	8	9,30	

CODICE - CODE	
K2CCEM...TG	K2CCEM...FOR-TG
K2CCEM6TG	K2CCEM6FOR-TG
K2CCEM8TG	K2CCEM8FOR-TG
K2CCEM10TG	K2CCEM10FOR-TG

Confezione / Box / Colis:
M3 – M10: 10 pezzi / pcs

K-ROLL

MASCHI A RULLARE
 Roll form taps - Tarauds à refoiler

MASCHI A MACCHINA

MACHINE TAPS - TARAUDS MACHINE

DIN 371

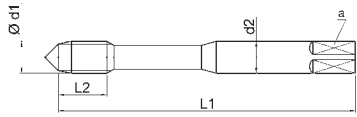

DIN 371

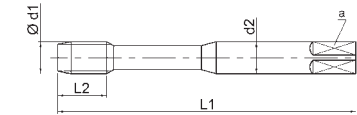

DIN 374

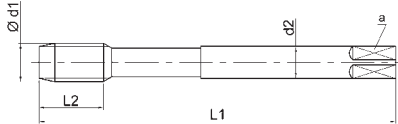

60°
P

RH

C
2-3

Z

Rm
N/mm²
1200

CNC

Z

TOP



6HX

TOP



6GX

Profond. di filettatura - Thread depth - Profond. de filetage

Materiale - Material - Matériau

Tolleranza - Tolerance - Tolérance

Trattamento superficiale - Surface treatment - Revêtement

3xD

PM8

6HX

TiN-G

1.3 1.4 1.5

2.2 2.3 2.4

3xD

PM8

6GX

TiN-G

1.3 1.4 1.5

2.2 2.3 2.4

Numero gruppi materiali
 Material's groups number
 Nombre de groupes du matériau

DIN 371	Ød1 MF	P mm	L1	L2	d2 h9	a h12	Z	
4	0,5	63	7	4,5	3,4	4	3,75	
5	0,5	70	8	6	4,9	5	4,75	
6	0,75	80	10	6	4,9	5	5,65	
8	1	90	13	8	6,2	5	7,55	
10	1	90	10	10	8	8	9,55	
10	1,25	100	15	10	8	8	9,45	

CODICE - CODE	
K2CCMF...TG	K3CCMF...TG
K2CCMF4x0,5TG	K3CCMF4x0,5TG
K2CCMF5x0,5TG	K3CCMF5x0,5TG
K2CCMF6x0,75TG	K3CCMF6x0,75TG
K2CCMF8x1TG	K3CCMF8x1TG
K2CCMF10x1TG	K3CCMF10x1TG
K2CCMF10x1,25TG	K3CCMF10x1,25TG

DIN 374	Ød1 MF	P mm	L1	L2	d2 h9	a h12	Z	
12	1	100	15	9	7	8	11,55	
12	1,25	100	15	9	7	8	11,45	
12	1,5	100	15	9	7	8	11,30	
14	1,25	100	15	11	9	8	13,45	
14	1,5	100	15	11	9	8	13,30	
16	1,5	100	15	12	9	8	15,30	

CODICE - CODE	
K2CCMF...TG	K3CCMF...TG
K2CCMF12x1TG	K3CCMF12x1TG
K2CCMF12x1,25TG	K3CCMF12x1,25TG
K2CCMF12x1,5TG	K3CCMF12x1,5TG
K2CCMF14x1,25TG	K3CCMF14x1,25TG
K2CCMF14x1,5TG	K3CCMF14x1,5TG
K2CCMF16x1,5TG	K3CCMF16x1,5TG

Confezione / Box / Colis:
 M3 – M10: 10 pezzi / pcs
 M12 – M16: 5 pezzi / pcs

K-ROLL

MASCHI A RULLARE
 Roll form taps - Tarauds à refouler

MASCHI A MACCHINA
 MACHINE TAPS - TARAUDS MACHINE

DIN 371

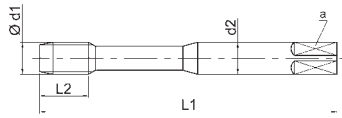

DIN 374

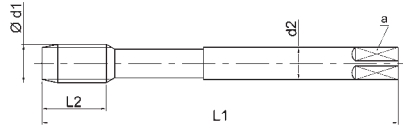

60° P RH C 2-3 Rm Nmm² 1200 CNC Z



Profond. di filettatura - Thread depth - Profond. de filetage
 Materiale - Material - Matériau
 Tolleranza - Tolerance - Tolérance
 Trattamento superficiale - Surface treatment - Revêtement

Numero gruppi materiali
 Material's groups number
 Nombre de groupes du matériau

3xD PM8 6HX TiN-G
 1.3 1.4 1.5 2.2 2.3 2.4

DIN 371	Ød1 MF	P mm	L1	L2	d2 h9	a h12	Z	
	8	1	90	13	8	6,2	5	7,55
	10	1	90	10	10	8	8	9,55
	10	1,25	100	15	10	8	8	9,45

CODICE - CODE	
K2CCMF...FOR-TG	K2CCMF...FORY-TG
K2CCMF8x1FOR-TG	K2CCMF8x1FORY-TG
K2CCMF10x1FOR-TG	K2CCMF10x1FORY-TG
K2CCMF10x1,25FOR-TG	K2CCMF10x1,25FORY-TG

DIN 374	Ød1 MF	P mm	L1	L2	d2 h9	a h12	Z	
	12	1	100	15	9	7	8	11,55
	12	1,25	100	15	9	7	8	11,45
	12	1,5	100	15	9	7	8	11,30
	14	1,5	100	15	11	9	8	13,30
	16	1,5	100	15	12	9	8	15,30

CODICE - CODE	
K2CCMF...FOR-TG	K2CCMF...FORY-TG
K2CCMF12x1FOR-TG	K2CCMF12x1FORY-TG
K2CCMF12x1,25FOR-TG	K2CCMF12x1,25FORY-TG
K2CCMF12x1,5FOR-TG	K2CCMF12x1,5FORY-TG
K2CCMF14x1,5FOR-TG	K2CCMF14x1,5FORY-TG
K2CCMF16x1,5FOR-TG	K2CCMF16x1,5FORY-TG

Confezione / Box / Colis:
 M3 – M10: 10 pezzi / pcs
 M12 – M16: 5 pezzi / pcs

K-ROLL

MASCHI A RULLARE
 Roll form taps - Tarauds à refouler

MASCHI A MACCHINA

MACHINE TAPS - TARAUDS MACHINE

DIN 371

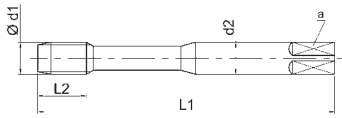

DIN 374

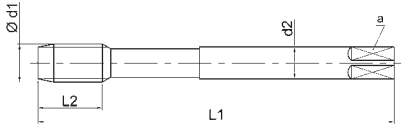

60°

RH

E
1,5 - 2

CNC

Rm
N/mm² 1200

L

Z

TOP



TOP

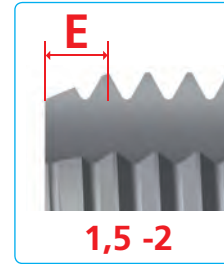

Profond. di filettatura - Thread depth - Profond. de filetage

Materiale - Material - Matériau

Tolleranza - Tolerance - Tolérance

Trattamento superficiale - Surface treatment - Revêtement

Numero gruppi materiali
 Material's groups number
 Nombre de groupes du matériau

3xD	3xD
PM8	PM8
6HX	6HX
TiN-G	TiN-G
1.3 1.4 1.5	1.3 1.4 1.5
2.2 2.3 2.4	2.2 2.3 2.4

DIN 371	Ød1 MF	P mm	L1	L2	d2 h9	a h12	Z	
8	1	90	13	8	6,2	5	7,55	
10	1	90	10	10	8	8	9,55	
10	1,25	100	15	10	8	8	9,45	

CODICE - CODE	
K2CCEMF...TG	K2CCEMF...FOR-TG
K2CCEMF8x1TG	K2CCEMF8x1FOR-TG
K2CCEMF10x1TG	K2CCEMF10x1FOR-TG
K2CCEMF10x1,25TG	K2CCEMF10x1,25FOR-TG

DIN 374	Ød1 MF	P mm	L1	L2	d2 h9	a h12	Z	
12	1	100	15	9	7	8	11,55	
12	1,25	100	15	9	7	8	11,45	
12	1,5	100	15	9	7	8	11,30	
14	1,5	100	15	11	9	8	13,30	
16	1,5	100	15	12	9	8	15,30	

CODICE - CODE	
K2CCEMF...TG	K2CCEMF...FOR-TG
K2CCEMF12x1TG	K2CCEMF12x1FOR-TG
K2CCEMF12x1,25TG	K2CCEMF12x1,25FOR-TG
K2CCEMF12x1,5TG	K2CCEMF12x1,5FOR-TG
K2CCEMF14x1,5TG	K2CCEMF14x1,5FOR-TG
K2CCEMF16x1,5TG	K2CCEMF16x1,5FOR-TG

Confezione / Box / Colis:
 M3 – M10: 10 pezzi / pcs
 M12 – M16: 5 pezzi / pcs

K-ROLL

MASCHI A RULLARE
Roll form taps - Tarauds à refouler

MASCHI A MACCHINA

MACHINE TAPS - TARAUDS MACHINE

DIN 5156

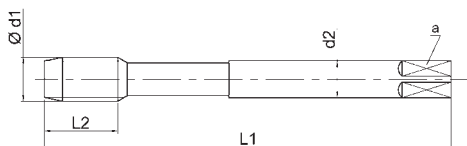

55° RH C 2-3 CNC
Rm 1200 Z

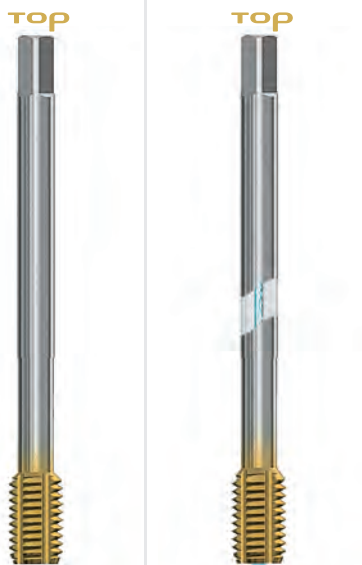

Profond. di filettatura - Thread depth - Profond. de filetage
Materiale - Material - Matériau
Tolleranza - Tolerance - Tolérance
Trattamento superficiale - Surface treatment - Revêtement
Numero gruppi materiali
Material's groups number
Nombre de groupes du matériau

3xD PM8 ISO 228X TiN-G 1.3 1.4 1.5 2.2 2.3 2.4

DIN 5156	Ød1 GAS	P TPI	Ø mm	L ₁	L ₂	d ₂ h9	a h12	Z	
	1/8	28	9,73	90	10	7	5,5	8	9,25
	1/4	19	13,16	100	13	11	9	8	12,5
	3/8	19	16,66	100	13	12	9	8	16
	1/2	14	20,96	125	18	16	12	8	20
new	5/8	14	22,91	125	18	18	14,5	8	22
	3/4	14	26,44	140	18	20	16	8	25,5
new	7/8	14	30,20	150	18	22	18	8	29,25
new	1	11	33,25	160	23	25	20	8	32

CODICE - CODE	
K2CCG...TG	K2CCG...FOR-TG
K2CCG1/8TG	K2CCG1/8FOR-TG
K2CCG1/4TG	K2CCG1/4FOR-TG
K2CCG3/8TG	K2CCG3/8FOR-TG
K2CCG1/2TG	K2CCG1/2FOR-TG
K2CCG5/8TG	K2CCG5/8FOR-TG
K2CCG3/4TG	K2CCG3/4FOR-TG
K2CCG7/8TG	K2CCG7/8FOR-TG
K2CCG1"TG	K2CCG1"FOR-TG

Confezione: Singola
Box: Single
Colis: Unique





M Filettatura metrica ISO passo grosso DIN 13

ISO Metric coarse thread DIN 13

Metrisches ISO-Regelgewinde DIN13 – Handgewindebohrer

Filetage métrique ISO DIN 13 – Tarauds à main

Rosca ISO métrica regular DIN13 – Machos de rosca a mano



N

USO GENERALE

General purpose - Usage Général

MASCHI A MANO

HAND TAPS - TARAUDS MAIN

DIN
352

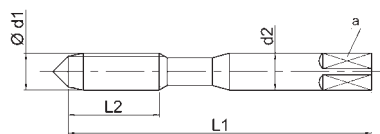

Profond. di filettatura - Thread depth - Profond. de filetage

Materiale - Material - Matériau

Tolleranza - Tolerance - Tolérance

Trattamento superficiale - Surface treatment - Revêtement

Numero gruppi materiali

Material's groups number

Nombre de groupes du matériau

LINE

LINE

LINE

LINE

A
5-6D
4-5C
2-3

2xD	2xD	2xD	2xD
HSS	HSS	HSS	HSS
-	-	ISO2/6H	ISO2/6H
BR	BR	BR	BR
1.1 1.2 1.3 1.4	1.1 1.2 1.3 1.4	1.1 1.2 1.3 1.4	1.1 1.2 1.3 1.4
2.1 2.2 2.3 3.1 3.4	2.1 2.2 2.3 3.1 3.4	2.1 2.2 2.3 3.1 3.4	2.1 2.2 2.3 3.1 3.4
4.1 4.2 4.3 4.4	4.1 4.2 4.3 4.4	4.1 4.2 4.3 4.4	4.1 4.2 4.3 4.4
5.1 5.2 5.3	5.1 5.2 5.3	5.1 5.2 5.3	5.1 5.2 5.3

DIN 352	Ød1 M	P mm	L ₁	L ₂	d ₂ h9	a h12	Z	
◀	2	0,4	36	8	2,8	2,1	3	1,6
◀	2,5	0,45	40	9	2,8	2,1	3	2,05
◀	2,6	0,45	40	9	2,8	2,1	3	2,1
◀	3	0,5	40	9	3,5	2,7	3	2,5
◀	3,5	0,6	45	10	4	3	3	2,9
◀	4	0,7	45	11	4,5	3,4	3	3,3
◀	4,5	0,75	50	13	6	4,9	3	3,7
◀	5	0,8	50	13	6	4,9	3	4,2
◀	6	1	56	15	6	4,9	3	5

CODICE - CODE			
01M...	02M...	03M...	00M...
○	○	●	●
○	○	●	●
○	○	○	○
○	○	●	●
○	○	○	○
○	○	○	○
○	○	●	●
○	○	●	●

Segue diametri
Diameters, to be continued
Diamètres à suivre

Pag. 3

★ Ad esaurimento scorte
Stock clearance - Stock épuisé

Confezione: Singola
Box: Single
Colis: Unique

€ Pag. listino - Price list - Liste des prix

● Standard

○ Disponibilità da richiedere, prezzo a listino
On enquiry, standard price-list / Stock à vérifier

★ Solo a richiesta
Only on request / Sur demande

M Filettatura metrica ISO passo grosso DIN 13

ISO Metric coarse thread DIN 13

Metrisches ISO-Regelgewinde DIN13 – Handgewindebohrer

Filetage métrique ISO DIN 13 – Tarauds à main

Rosca ISO métrica regular DIN13 – Machos de rosca a mano

N

USO GENERALE

General purpose - Usage Général

MASCHI A MANO, FILETTATURA SINISTRA

LEFT HAND TAPS - TARAUDS MAIN GAUCHE

DIN 352

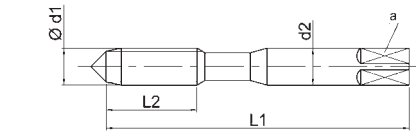

DIN 352

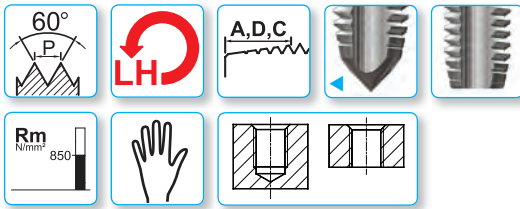
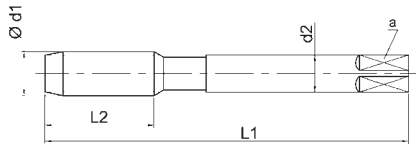

LINE

LINE

LINE

LINE

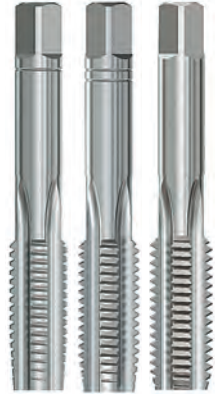
A
5-6D
4-5C
2-3

Profond. di filettatura - Thread depth - Profond. de filetage

Materiale - Material - Matériau

Tolleranza - Tolerance - Tolérance

Trattamento superficiale - Surface treatment - Revêtement

Numero gruppi materiali

Material's groups number

Nombre de groupes du matériau

2XD

2xD

2xD

2xD

HSS

HSS

HSS

HSS

-

-

ISO2/6H

ISO2/6H

BR

BR

BR

BR

1.1 1.2 1.3 1.4

1.1 1.2 1.3 1.4

1.1 1.2 1.3 1.4

1.1 1.2 1.3 1.4

2.1 2.2 2.3 3.1 3.4

2.1 2.2 2.3 3.1 3.4

2.1 2.2 2.3 3.1 3.4

2.1 2.2 2.3 3.1 3.4

4.1 4.2 4.3 4.4

4.1 4.2 4.3 4.4

4.1 4.2 4.3 4.4

4.1 4.2 4.3 4.4

5.1 5.2 5.3

5.1 5.2 5.3

5.1 5.2 5.3

5.1 5.2 5.3

DIN 352	Ød1 M	P mm	L ₁	L ₂	d ₂ h9	a h12	Z	
◀	3	0,5	40	9	3,5	2,7	3	2,5
◀	4	0,7	45	11	4,5	3,4	3	3,3
◀	5	0,8	50	13	6	4,9	3	4,2
◀	6	1	56	15	6	4,9	3	5
	8	1,25	63	19	6	4,9	3	6,8
	10	1,5	70	22	7	5,5	3	8,5
	12	1,75	75	28	9	7	4	10,30
	14	2	80	30	11	9	4	12
	16	2	80	30	12	9	4	14
	18	2,5	95	34	14	11	4	15,5
	20	2,5	95	34	16	12	4	17,5
	22	2,5	100	34	18	14,5	4	19,5
	24	3	110	38	18	14,5	4	21
	27	3	110	38	20	16	4	24
	30	3,5	125	45	22	18	4	26,5

CODICE - CODE

01M...LH

02M...LH

03M...LH

00M...LH

○

○

○

○

○

○

○

●

○

○

○

●

○

○

○

●

○

○

○

●

○

○

○

○

○

○

○

○

○

○

○

○

○

○

○

○

○

○

○

○

○

○

○

○

○

○

○

○

○

○

○

○

○

○

○

○

○

○

○

○

○

○

○

○

○

○

○

○

○

○

○

○

○

○

○

○

○

○

○

○

○

○

○

○

○

○

○

○

○

○

○

○

○

○

○

○

○

○

○

○

○

○

○

○

○

○

○

○

○

○

○

○

○

○

○

○

○

○

○

○

○

○

○

○

○

○

○

○

***** Ad esaurimento scorte
Stock clearance - Stock épuisé

Confezione: Singola
Box: Single
Colis: Unique

€ Pag. listino - Price list - Liste des prix

2

2

2

2

● Standard

○ Disponibilità da richiedere, prezzo a listino
On enquiry, standard price-list / Stock à vérifier★ Solo a richiesta
Only on request / Sur demande

M Filettatura metrica ISO passo grosso DIN 13

ISO Metric coarse thread DIN 13

Metrisches ISO-Regelgewinde DIN13 – Maschinengewindebohrer

Filetage métrique ISO DIN 13 – Tarauds machine

Rosca ISO métrica regular DIN13 – Machos de rosca a máquina

N

USO GENERALE

General purpose - Usage Général

MASCHI A MACCHINA

MACHINE TAPS - TARAUDS MACHINE

DIN 357

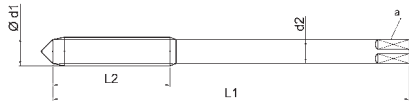

DIN 357

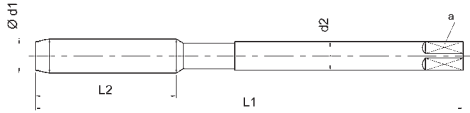

LINE



1,5xD

HSSE

ISO2/6H

BR

1.1 1.2 1.3 1.4

LINE



1,5xD

HSSE

ISO2/6H

BR

1.1 1.2 1.3 1.4

LINE



3xD

HSSE

ISO2/6H

BR

1.1 1.2 1.3 1.4

Profond. di filettatura - Thread depth - Profond. de filetage

Materiale - Material - Matériau

Tolleranza - Tolerance - Tolérance

Trattamento superficiale - Surface treatment - Revêtement

Numero gruppi materiali

Material's groups number

Nombre de groupes du matériau

DIN 357	Ød1 M	P mm	L ₁	L ₂	d ₂ h9	a h12	Z	
3	0,5	70	22	2,2	1,75	3	2,5	
4	0,7	90	25	2,8	2,1	3	3,3	
5	0,8	100	28	3,5	2,7	3	4,2	
6	1	110	32	4,5	3,4	3	5	
8	1,25	125	40	6	4,9	3	6,8	
10	1,5	140	45	7	5,5	3	8,5	
12	1,75	180	50	9	7	3	10,30	
14	2	200	56	11	9	3	12	
16	2	200	63	12	9	3	14	

CODICE - CODE

10FCM...

10FPM...

12FPM...

*

○

○

○

○

○

○

○

○

○

○

○

○

○

○

○

○

○

○

○

○

○

○

○

Confezione: Singola
Box: Single
Colis: Unique

€ Pag. listino - Price list - Liste des prix

3

3

3

● Standard

○ Disponibilità da richiedere, prezzo a listino
On enquiry, standard price-list / Stock à vérifier

★ Solo a richiesta
Only on request / Sur demande

OT

OTTONE
Brass - Laiton

MASCHI A MACCHINA

MACHINE TAPS - TARAUDS MACHINE

DIN 371

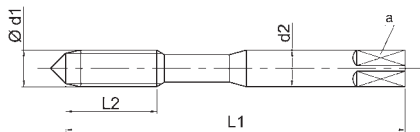

DIN 371

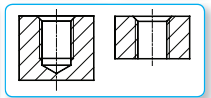
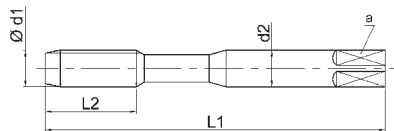

LINE



Ms58

LINE



Ms58

LINE



LINE



Profond. di filettatura - Thread depth - Profond. de filetage

Materiale - Material - Matériau

Tolleranza - Tolerance - Tolérance

Trattamento superficiale - Surface treatment - Revêtement

Numero gruppi materiali

Material's groups number

Nombre de groupes du matériau

3xD	3xD	3xD	3xD
HSSE	HSSE	HSSE	HSSE
ISO2/6H	ISO2/6H	ISO2/6H	ISO2/6H
BR	CrN	BR	TiCN
5.3	5.3	5.3	5.3
8.2 8.3	8.2 8.3	8.2 8.3	8.2 8.3

DIN 371	Ød1 M	P mm	L1	L2	d2 h9	a h12	Z	
3	0,5	56	10	3,5	2,7	2	2,5	
4	0,7	63	13	4,5	3,4	2	3,3	
5	0,8	70	13	6	4,9	2	4,2	
6	1	80	16	6	4,9	2	5	
8	1,25	90	18	8	6,2	2	6,8	
10	1,5	100	20	10	8	2	8,5	
3	0,5	56	10	3,5	2,7	3	2,5	
4	0,7	63	13	4,5	3,4	3	3,3	
5	0,8	70	13	6	4,9	3	4,2	
6	1	80	16	6	4,9	3	5	
8	1,25	90	18	8	6,2	3	6,8	
10	1,5	100	20	10	8	3	8,5	

LANCIAM...		CODICE - CODE	
LANCIAM...NC			
•	○	-	-
•	○	-	-
•	○	-	-
•	○	-	-
•	○	-	-
•	○	-	-
•	○	-	-
		E20M...-OT	E20M...-OT-CT
-	-	○	○
-	-	○	○
-	-	○	○
-	-	○	○
-	-	○	○
-	-	○	○

M Filettatura metrica ISO passo grosso DIN 13

ISO Metric coarse thread DIN 13

Metrisches ISO-Regelgewinde DIN13 – Maschinengewindebohrer

Filetage métrique ISO DIN 13 – Tarauds machine

Rosca ISO métrica regular DIN13 – Machos de rosca a máquina

N

USO GENERALE

General purpose - Usage Général

MASCHI A MACCHINA, FILETTATURA SINISTRA

LEFT THREAD MACHINE TAPS - TARAUDS MACHINE GAUCHE

DIN 371

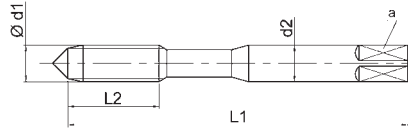

DIN 376

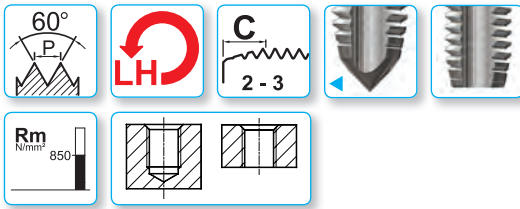
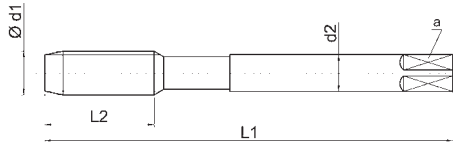

LINE



LINE



LINE



Profond. di filettatura - Thread depth - Profond. de filetage

Materiale - Material - Matériau

Tolleranza - Tolerance - Tolérance

Trattamento superficiale - Surface treatment - Revêtement

1,5xD

HSSE

ISO2/6H

BR

1.1 1.2 1.3 1.4 3.4

4.2 4.3 5.2 5.3

8.2

1,5xD

HSSE

ISO2/6H

V

1.1 1.2 1.3 1.4 3.4

4.2 4.3 5.2 5.3

8.2

1,5xD

HSSE

ISO2/6H

TiN

1.1 1.2 1.3 1.4 3.4

4.2 4.3 5.2 5.3

8.2

Numero gruppi materiali

Material's groups number

Nombre de groupes du matériau

DIN 371	Ød1 M	P mm	L ₁	L ₂	d ₂ h9	a h12	Z	
◀	3	0,5	56	10	3,5	2,7	3	2,5
◀	4	0,7	63	13	4,5	3,4	3	3,3
◀	5	0,8	70	13	6	4,9	3	4,2
◀	6	1	80	16	6	4,9	3	5,0
◀	8	1,25	90	18	8	6,2	3	6,8
◀	10	1,5	100	20	10	8	3	8,5

DIN 376	Ød1 M	P mm	L ₁	L ₂	d ₂ h9	a h12	Z	
	12	1,75	110	25	9	7	3	10,3
	14	2	110	28	11	9	3	12,0
	16	2	110	28	12	9	3	14,0
	18	2,5	125	33	14	11	4	15,5
	20	2,5	140	33	16	12	4	17,5
	22	2,5	140	33	18	14,5	4	19,5
	24	3	160	39	18	14,5	4	21,0
	27	3	160	39	20	16	4	24,0
	30	3,5	180	46	22	18	4	26,5
	33	3,5	180	46	25	20	4	29,5
	36	4	200	50	28	22	4	32,0
	39	4	200	50	32	24	4	35,0
	42	4,5	200	55	32	24	5	37,5
■	45	4,5	220	60	36	29	5	40,5
■	48	5	250	65	36	29	5	43,0

CODICE - CODE	E20M...LH		
	E20M...LH-V	E20M...LH-T	
○	○	○	
○	○	○	
●	○	○	
●	○	○	
●	○	○	
●	○	○	

CODICE - CODE	E21M...LH		
	E21M...LH-V	E21M...LH-T	
●	○	○	
●	○	○	
●	○	○	
●	○	○	
●	○	○	
○	○	○	
●	○	○	
●	○	○	
●	○	○	
●	○	○	
*	*	*	
*	*	*	
*	*	*	
*	*	*	
*	*	*	
*	*	*	

■ = Acciaio HSS / HSS Steel

Confezione / Box / Colis:
M3 – M10: 10 pezzi / pcs
M12 – M16: 5 pezzi / pcs

€ Pag. listino - Price list - Liste des prix

● Standard

5

○ Disponibilità da richiedere, prezzo a listino
On enquiry, standard price-list / Stock à vérifier

6

6

★ Solo a richiesta
Only on request / Sur demande

Al-Cu-Fe

ALLUMINIO, RAME, ACCIAIO R ≤ 700 N/mm²

Al, Cu, Steel R≤700 N/mm² - Al, Cu, Acier R≤700 N/mm²

MASCHI A MACCHINA

MACHINE TAPS - TARAUDS MACHINE

DIN 371

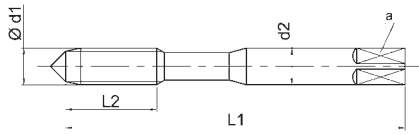

DIN 376

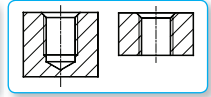
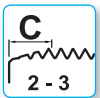
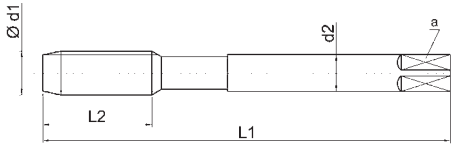

LINE



LINE



TOP



Profond. di filettatura - Thread depth - Profond. de filetage

Materiale - Material - Matériau

Tolleranza - Tolerance - Tolérance

Trattamento superficiale - Surface treatment - Revêtement

Numero gruppi materiali

Material's groups number

Nombre de groupes du matériau

1,5xD

HSSE

ISO2/6H

BR

1.1

4.1 4.2

5.1 5.2

8.1

1,5xD

HSSE

ISO2/6H

V

1.1

4.1 4.2

5.1 5.2

8.1

1,5xD

HSSE

ISO2/6H

TXC

1.1

4.1 4.2

5.1 5.2

8.1

DIN 371	Ød1 M	P mm	L1	L2	d2 h9	a h12	Z	
◀	3	0,5	56	10	3,5	2,7	3	2,5
◀	4	0,7	63	13	4,5	3,4	3	3,3
◀	5	0,8	70	13	6	4,9	3	4,2
◀	6	1	80	16	6	4,9	3	5
◀	7	1	80	16	7	5,5	3	6
◀	8	1,25	90	18	8	6,2	3	6,8
◀	10	1,5	100	20	10	8	3	8,5

E20M...AZ	CODICE - CODE	
	E20M...AZ-V	E20M...AZ-TXC
○	○	○
●	○	○
●	○	○
●	○	○
○	○	○
●	○	○
●	○	○

DIN 376	Ød1 M	P mm	L1	L2	d2 h9	a h12	Z	
	12	1,75	110	25	9	7	3	10,3
	14	2	110	28	11	9	3	12
	16	2	110	28	12	9	3	14

E21M...AZ	CODICE - CODE	
	E21M...AZ-V	E21M...AZ-TXC
○	○	○
○	○	○
○	○	○

Confezione / Box / Colis: M3 – M10: 10 pezzi / pcs M12 – M16: 5 pezzi / pcs	€ Pag. listino - Price list - Liste des prix	6	6	6
	● Standard	○ Disponibilità da richiedere, prezzo a listino On enquiry, standard price-list / Stock à vérifier		★ Solo a richiesta Only on request / Sur demande

M Filettatura metrica ISO passo grosso DIN 13

ISO Metric coarse thread DIN 13

Metrisches ISO-Regelgewinde DIN13 – Maschinengewindebohrer

Filetage métrique ISO DIN 13 – Tarauds machine

Rosca ISO métrica regular DIN13 – Machos de rosca a máquina



GG

GHISA
Cast Iron - Fonte

MASCHI A MACCHINA

MACHINE TAPS - TARAUDS MACHINE

DIN 371

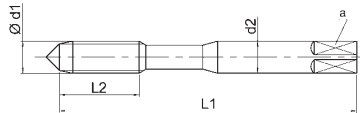

DIN 371

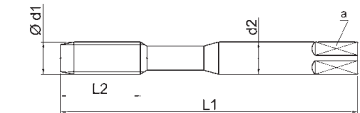

DIN 376

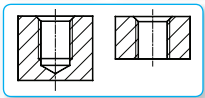
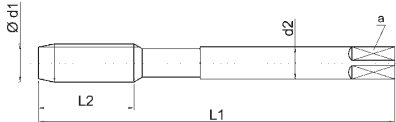

TOP



TOP



TOP



TOP



ADITAPS

Profond. di filettatura - Thread depth - Profond. de filetage

Materiale - Material - Matériau

Tolleranza - Tolerance - Tolérance

Trattamento superficiale - Surface treatment - Revêtement

Al Si > 10%,
Ottone / Brass / Laiton
Bronzo / Bronze / Bronze
truciolo corto / short chip /
coupeaux courts

Numero gruppi materiali
Material's groups number
Nombre de groupes du matériau

3xD	3,5xD	3,5xD	3xD
PM3	PM3	PM3	PM3
6HX	6HX	6HX	6HX
TiAIN	TiAIN	TiAIN	TXS
3.1 3.2 3.3 3.4 3.5	3.1 3.2 3.3 3.4 3.5	3.1 3.2 3.3 3.4 3.5	3.1 3.2 3.3 3.4 3.5
4.4 5.3 5.4	4.4 5.3 5.4	4.4 5.3 5.4	4.4 5.3 5.4
10.1	10.1	10.1	10.1

DIN 371	Ød1 M	P mm	L1	L2 10xP	d2 h9	a h12	Z	
◀	4	0,7	63	13	4,5	3,4	3	3,3
◀	5	0,8	70	13	6	4,9	3	4,2
◀	6	1	80	16	6	4,9	4	5
◀	8	1,25	90	18	8	6,2	4	6,8
◀	10	1,5	100	20	10	8	4	8,5
	6	1	80	16	6	4,9	4	5
	8	1,25	90	18	8	6,2	4	6,8
	10	1,5	100	20	10	8	4	8,5

DIN 376	Ød1 M	P mm	L1	L2 10xP	d2 h9	a h12	Z	
	12	1,75	110	25	9	7	4	10,3
	14	2	110	28	11	9	4	12
	16	2	110	28	12	9	4	14
	18	2,5	125	33	14	11	5	15,5
	20	2,5	140	33	16	12	5	17,5
	22	2,5	140	33	18	14,5	5	19,5
	24	3	160	39	18	14,5	5	21

CODICE - CODE			
K26M...TX			K26M...TXS
•			•
•			•
•			•
•			•
•			•
K26M...SP-TX	K26M...FOR-TX	K26M...FORY-TX	
○	○	○	
○	○	○	
○	○	○	

CODICE - CODE			
K27M...TX	K27M... FOR-TX	K27M...FORY-TX	K27M...TXS
•	○	○	•
•	○	○	•
•	○	○	•
○	○	○	○
○	○	○	○
○	○	○	○
○	○	○	○

Esecuzione in metallo duro integrale:
Solid carbide edition at page:
En Carbure:

Pag. 19

Confezione / Box / Colis:
M3 – M12: 5 pezzi / pcs / pièces
>M12: singoli / single pcs

€ Pag. listino - Price list - Liste des prix

8

8

8

8

• Standard

○ Disponibilità da richiedere, prezzo a listino
On enquiry, standard price-list / Stock à vérifier

★ Solo a richiesta
Only on request / Sur demande

GG GHISA
Cast Iron - Fonte

MASCHI A MACCHINA
MACHINE TAPS - TARAUDS MACHINE

DIN 371

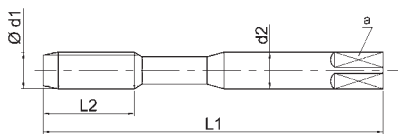

DIN 376

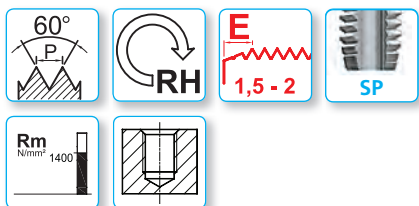
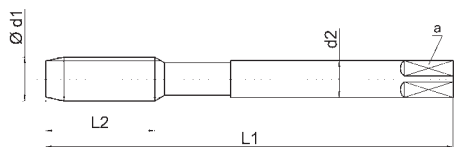

TOP



TOP



TOP



Profond. di filettatura - Thread depth - Profond. de filetage

Materiale - Material - Matériau

Tolleranza - Tolerance - Tolérance

Trattamento superficiale - Surface treatment - Revêtement

Al Si > 10%,
Ottone / Brass / Laiton
Bronzo / Bronze / Bronze
truciolo corto / short chip /
coupeaux courts

Numero gruppi materiali
Material's groups number
Nombre de groupes du matériau

3xD

PM3

6HX

TiAlN

3.1 3.2 3.3 3.4 3.5

4.4 5.3

10.1

3,5xD

PM3

6HX

TiAlN

3.1 3.2 3.3 3.4 3.5

4.4 5.3

10.1

3,5xD

PM3

6HX

TiAlN

3.1 3.2 3.3 3.4 3.5

4.4 5.3

10.1

DIN 371	Ød1 M	P mm	L1	L2	d2 h9	a h12	Z	
6	1	80	16	6	4,9	4	5	
8	1,25	90	18	8	6,2	4	6,8	
10	1,5	100	20	10	8	4	8,5	

CODICE - CODE		
K26EM...TX	K26EM...FOR-TX	K26EM...FORY-TX
<input type="radio"/>	<input type="radio"/>	<input type="radio"/>
<input type="radio"/>	<input type="radio"/>	<input type="radio"/>
<input type="radio"/>	<input type="radio"/>	<input type="radio"/>

DIN 376	Ød1 M	P mm	L1	L2	d2 h9	a h12	Z	
12	1,75	110	25	9	7	4	10,3	
14	2	110	28	11	9	4	12	
16	2	110	28	12	9	4	14	
18	2,5	125	33	14	11	5	15,5	
20	2,5	140	33	16	12	5	17,5	
22	2,5	140	33	18	14,5	5	19,5	
24	3	160	39	18	14,5	5	21	

CODICE - CODE		
K27EM...TX	K27EM... FOR-TX	K27EM...FORY-TX
<input type="radio"/>	<input type="radio"/>	<input type="radio"/>
<input type="radio"/>	<input type="radio"/>	<input type="radio"/>
<input type="radio"/>	<input type="radio"/>	<input type="radio"/>
<input type="radio"/>	<input type="radio"/>	<input type="radio"/>
<input type="radio"/>	<input type="radio"/>	<input type="radio"/>
<input type="radio"/>	<input type="radio"/>	<input type="radio"/>
<input type="radio"/>	<input type="radio"/>	<input type="radio"/>

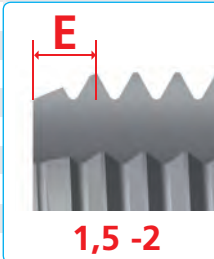

Confezione / Box / Colis: M3 - M12: 5 pezzi / pcs / pièces >M12: singoli/single pcs

€ Pag. listino - Price list - Liste des prix

8 8 9

● Standard ○ Disponibilità da richiedere, prezzo a listino On enquiry, standard price-list / Stock à vérifier ★ Solo a richiesta Only on request / Sur demande

M Filettatura metrica ISO passo grosso DIN 13

ISO Metric coarse thread DIN 13

Metrisches ISO-Regelgewinde DIN13 – Maschinengewindebohrer

Filetage métrique ISO DIN 13 – Tarauds machine

Rosca ISO métrica regular DIN13 – Machos de roscar a máquina



MASCHI A MACCHINA

MACHINE TAPS - TARAUDS MACHINE

SYNCHRO RIGID

MASCHIATURA RIGIDA SINCRONIZZATA

Rigid Tapping Synchro - Taraudage rigide synchronisé

DIN 371

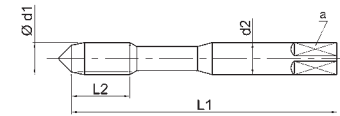

DIN 371

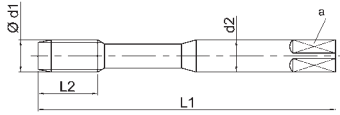

UFS norm

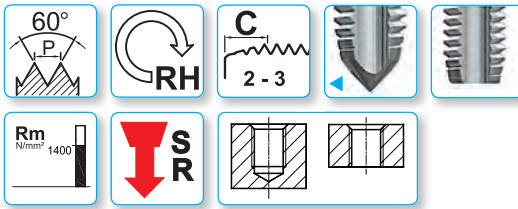
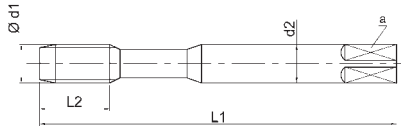

TOP



TOP



TOP



Profond. di filettatura - Thread depth - Profond. de filetage

Materiale - Material - Matériau

Tolleranza - Tolerance - Tolérance

Trattamento superficiale - Surface treatment - Revêtement

Ghisa / Cast iron / Fonte
Acciaio alta resistenza
High resistance Steel
Acier haute résistance
Al Si>10%

Numero gruppi materiali
Material's groups number
Nombre de groupes du matériau

3xD

PM3

6HX

TXC

1.5 1.6

3.1 3.2 3.3 3.4 3.5

4.3 4.4 4.5 4.6 5.3 5.4

8.2 8.3 10.1

3,5xD

PM3

6HX

TXC

1.5 1.6

3.1 3.2 3.3 3.4 3.5

4.3 4.4 4.5 4.6 5.3 5.4

8.2 8.3 10.1

3,5xD

PM3

6HX

TXC

1.5 1.6

3.1 3.2 3.3 3.4 3.5

4.3 4.4 4.5 4.6 5.3 5.4

8.2 8.3 10.1

DIN 371	$\varnothing d_1$ M	P mm	L_1	L_2 10xP	d_2 h6	a h12	Z	
6	1	80	10	6	4,9	4	5	
8	1,25	90	13	8	6,2	4	6,8	
10	1,5	100	15	10	8	4	8,5	

UFS norm	$\varnothing d_1$ M	P mm	L_1	L_2 10xP	d_2 h6	a h12	Z	
12	1,75	110	18	12	9	4	10,3	
14	2	110	20	12	9	4	12	
16	2	110	20	16	12	4	14	

CODICE - CODE		
S20M...TXC	S20M...FOR-TXC	S20M...FORY-TXC
<input type="radio"/>	<input type="radio"/>	<input type="radio"/>
<input type="radio"/>	<input type="radio"/>	<input type="radio"/>
<input type="radio"/>	<input type="radio"/>	<input type="radio"/>

CODICE - CODE		
S20M...TXC	S20M...FOR-TXC	S20M...FORY-TXC
<input type="radio"/>	<input type="radio"/>	<input type="radio"/>
<input type="radio"/>	<input type="radio"/>	<input type="radio"/>
<input type="radio"/>	<input type="radio"/>	<input type="radio"/>

A richiesta:
On request:
Sur demande:
Con **Weldon** DIN1835 B



Confezione / Box / Colis:
M3 – M12: 5 pezzi / pcs
>M12: singoli / single pcs

€ Pag. listino - Price list - Liste des prix

9

9

9

● Standard

○ Disponibilità da richiedere, prezzo a listino
On enquiry, standard price-list / Stock à vérifier

★ Solo a richiesta
Only on request / Sur demande

M Filettatura metrica ISO passo grosso DIN 13

ISO Metric coarse thread DIN 13
Metrisches ISO-Regelgewinde DIN13 – Maschinengewindebohrer
Filetage métrique ISO DIN 13 – Tarauds machine
Rosca ISO métrica regular DIN13 – Machos de rosca a máquina



HR

ALTA RESISTENZA
High Resistance - Haute Résistance

MASCHI A MACCHINA
MACHINE TAPS - TARAUDS MACHINE

~DIN 371

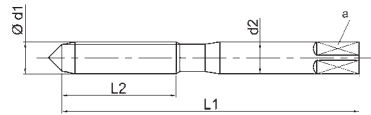

~DIN 371

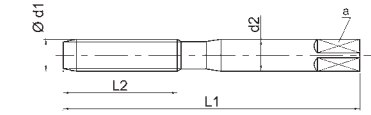

UFS norm

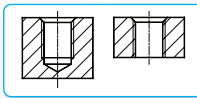
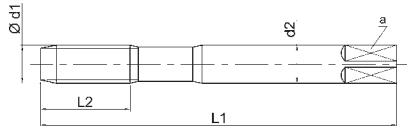

TOP



≤ 52HRC

TOP



≤ 52HRC

Profond. di filettatura - Thread depth - Profond. de filetage

Materiale - Material - Matériau

Tolleranza - Tolerance - Tolérance

Trattamento superficiale - Surface treatment - Revêtement

Numero gruppi materiali

Material's groups number

Nombre de groupes du matériau

2xD

1,5xD

PM1

PM1

6HX

6HX

TiAlN

TiAlN

1.6 1.7

1.6 1.7

5.4

5.4

9.1 9.3

9.1 9.3

~DIN 371	Ød1 M	P mm	L ₁	L ₂	d ₂ h9	a h12	Z	
◀	4	0,7	63	13	4,5	3,4	4	3,3
◀	5	0,8	70	13	6	4,9	4	4,2
◀	6	1	80	16	6	4,9	4	5
	8	1,25	90	18	8	6,2	5	6,8
	10	1,5	100	20	10	8	5	8,5
	6	1	80	18	6	4,9	4	5
	8	1,25	90	25	8	6,2	5	6,8
	10	1,5	100	30	10	8	5	8,5

UFS norm	Ød1 M	P mm	L ₁	L ₂	d ₂ h9	a h12	Z	
	12	1,75	110	25	9	7	5	10,3
	12	1,75	110	30	12	9	5	10,3

CODICE - CODE

XT20M...

○

○

○

○

○

XT20M...TX

-

-

-

CODICE - CODE

XT21M...

○

XT20M...TX

-

Ad esaurimento scorte
Stock clearance - Stock épuisé

 Confezione / Box / Colis:
M3 – M12: 5 pezzi / pcs
>M12: singoli / single pcs

€ Pag. listino - Price list - Liste des prix

10

10

● Standard

○ Disponibilità da richiedere, prezzo a listino
On enquiry, standard price-list / Stock à vérifier★ Solo a richiesta
Only on request / Sur demande

MDI-HM METALLO DURO INTEGRALE - ALTA RESISTENZA
Solid carbide, high resistance - Carbure, haute résistance

MASCHI A MACCHINA
MACHINE TAPS - TARAUDS MACHINE

DIN 371

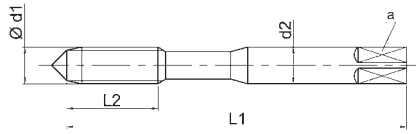

UFS norm

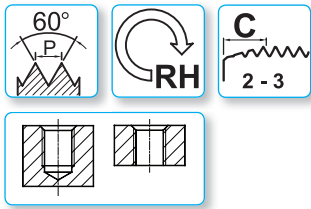
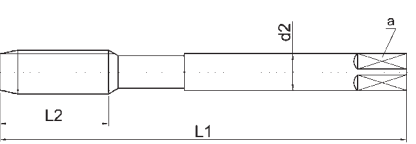

TOP



TOP



TOP



45-62 HRC

Profond. di filettatura - Thread depth - Profond. de filetage
Materiale - Material - Matériau
Tolleranza - Tolerance - Tolérance
Trattamento superficiale - Surface treatment - Revêtement
Ghisa / Cast Iron / Fonte
Al Si>10%,
Ottone / Brass / Laiton
Bronzo / Bronze / Bronze
truciolo corto / short chip /
coupeaux courts

Numero gruppi materiali
Material's groups number
Nombre de groupes du matériau

3,5xD	3,5xD	1,5xD
MDI-HM	MDI-HM	MDI-HM
6HX	6HX	6HX
BR	TICN	TICN
3.1 3.2 3.3 3.4 3.5	3.1 3.2 3.3 3.4 3.5	1.7 1.8
4.3 4.4 4.5 4.6	4.3 4.4 4.5 4.6	5.4
5.3 5.4 8.2 8.3	5.3 5.4 8.2 8.3	9.1 9.3
10.1	10.1	

DIN 371	Ød1 M	P mm	L1	L2	d2 h6	a h12	Z	
6	1	80	16	6	4,9	-	5	
8	1,25	90	18	8	6,2	-	6,8	
10	1,5	100	20	10	8	-	8,5	
6	1	80	18	6	4,9	-	5	
8	1,25	90	25	8	6,2	-	6,8	
10	1,5	100	30	10	8	-	8,5	

CODICE - CODE	
HM20M...FOR	HM20M...FOR-CT
*	*
*	*
*	*
	HM-XT20M...CT
-	*
-	*
-	*

UFS norm	Ød1 M	P mm	L1	L2	d2 h6	a h12	Z	
12	1,75	110	25	9	7	-	10,3	
14	2	110	22	11	9	-	12	
16	2	110	22	12	9	-	14	
18	2,5	125	24	14	11	-	15,5	
20	2,5	140	25	16	12	-	17,5	
12	1,75	110	30	12	9	-	10,3	
16	2	110	40	16	12	-	14,25	

CODICE - CODE	
HM21M...FOR	HM21M...FOR-CT
*	*
*	*
*	*
*	*
*	*
	HM-XT20M...CT
-	*
-	*

Confezione / Box / Colis: M3 – M12: 5 pezzi / pcs >M12: singoli / single pcs

€ Pag. listino - Price list - Liste des prix

● Standard

○ Disponibilità da richiedere, prezzo a listino On enquiry, standard price-list / Stock à vérifier

* Solo a richiesta Only on request / Sur demande



Filettatura metrica ISO passo grosso DIN 13

*ISO Metric coarse thread DIN 13
Metrisches ISO-Regelgewinde DIN13 – Maschinengewindebohrer
Filetage métrique ISO DIN 13 – Tarauds machine
Rosca ISO métrica regular DIN13 – Machos de rosca a máquina*



N **USO GENERALE**
General purpose - Usage Général

MASCHI A MACCHINA

MACHINE TAPS - TARAUDS MACHINE

DIN 371

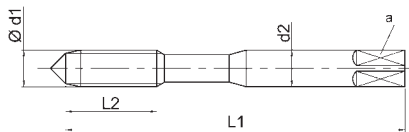

DIN 371

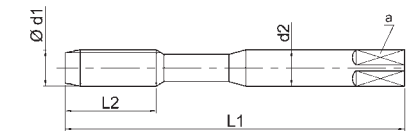

LINE

LINE

LINE

LINE



Profond. di filettatura - Thread depth - Profond. de filetage

Materiale - Material - Matériau

Tolleranza - Tolerance - Tolérance

Trattamento superficiale - Surface treatment - Revêtement

Numero gruppi materiali
Material's groups number
Nombre de groupes du matériau



3xD	3xD	3xD	3xD
HSSE	HSSE	HSSE	HSSE
ISO2/6H	ISO2/6H	ISO2/6H	ISO2/6H
BR	V	TiN	TXC
1.1 1.2 1.3 1.4	1.1 1.2 1.3 1.4	1.1 1.2 1.3 1.4	1.1 1.2 1.3 1.4
4.1 4.2	4.1 4.2	3.3 3.4	2.1 2.2 3.3 3.4
5.1 5.2	5.1 5.2	4.1 4.2 4.3	4.2 4.3
	6.1 7.1	5.1 5.2	5.2

DIN 371	Ød1 M	P mm	L ₁	L ₂	d ₂ h ₉	a h ₁₂	Z	
▶	1	0,25	40	5	2,5	2,1	-	0,75
▶	1,2	0,25	40	5	2,5	2,1	-	0,95
▶	1,4	0,3	40	7	2,5	2,1	-	1,1
▶	1,6	0,35	40	8	2,5	2,1	-	1,25
▶	1,7	0,35	40	8	2,5	2,1	-	1,35
▶	1,8	0,35	40	8	2,5	2,1	-	1,45
▶	2	0,4	45	10	2,8	2,1	3	1,6
▶	2,2	0,45	45	10	2,8	2,1	3	1,75
▶	2,3	0,4	45	10	2,8	2,1	3	1,9
▶	2,5	0,45	50	13	2,8	2,1	3	2,05
▶	2,6	0,45	50	13	2,8	2,1	3	2,10
▶	3	0,5	56	10	3,5	2,7	3	2,5
▶	3,5	0,6	56	11	4	3	3	2,9
▶	4	0,7	63	13	4,5	3,4	3	3,3
▶	4,5	0,75	70	13	6	4,9	3	3,7
▶	5	0,8	70	13	6	4,9	3	4,2
▶	6	1	80	16	6	4,9	3	5
▶	7	1	80	16	7	5,5	3	6
▶	8	1,25	90	18	8	6,2	3	6,8
▶	9	1,25	90	18	9	7	3	7,8
▶	10	1,5	100	20	10	8	3	8,5

E24M...	CODICE - CODE		
	E24M...V	E24M...T	E24M...TXC
*	-	-	-
*	-	-	-
*	-	-	-
*	-	-	-
*	-	-	-
*	-	-	-
•	○	○	*
○	○	○	*
○	○	○	*
•	○	○	*
○	○	○	*
•	•	•	•
○	○	○	○
•	•	•	•
•	•	•	•
○	○	○	○
•	•	•	•
○	○	○	○
•	•	•	•
•	•	•	•
•	•	•	•
•	•	•	•
•	•	•	•
•	•	•	•
•	•	•	•
•	•	•	•
•	•	•	•

N USO GENERALE
General purpose - Usage Général

MASCHI A MACCHINA
MACHINE TAPS - TARAUDS MACHINE

DIN 376

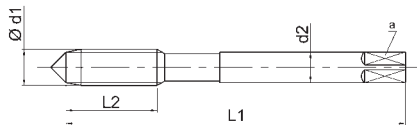

DIN 376

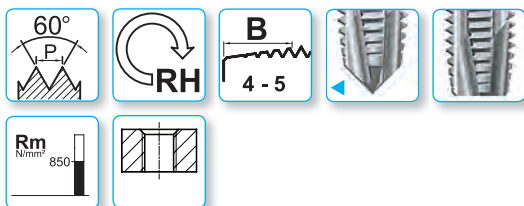
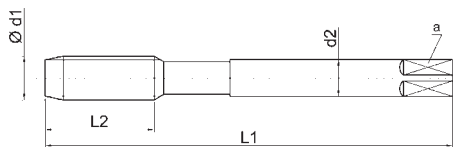

LINE



LINE



LINE



LINE



Profond. di filettatura - Thread depth - Profond. de filetage

Materiale - Material - Matériau

Tolleranza - Tolerance - Tolérance

Trattamento superficiale - Surface treatment - Revêtement

Numero gruppi materiali
Material's groups number
Nombre de groupes du matériau

3xD	3xD	3xD	3xD
HSSE	HSSE	HSSE	HSSE
ISO2/6H	ISO2/6H	ISO2/6H	ISO2/6H
BR	V	TiN	TXC
1.1 1.2 1.3 1.4	1.1 1.2 1.3 1.4	1.1 1.2 1.3 1.4	1.1 1.2 1.3 1.4
4.1 4.2	4.1 4.2	3.3 3.4	2.1 2.2 3.3 3.4
5.1 5.2	5.1 5.2	4.1 4.2 4.3	4.2 4.3
	6.1 7.1	5.1 5.2	5.2

DIN 376	Ød1 M	P mm	L ₁	L ₂	d ₂ h9	a h12	Z	
4	0,7	63	13	2,8	2,1	3	3,3	
5	0,8	70	13	3,5	2,7	3	4,2	
6	1	80	16	4,5	3,4	3	5	
8	1,25	90	18	6	4,9	3	6,8	
10	1,5	100	20	7	5,5	3	8,5	
11	1,5	100	20	8	6,2	3	9,5	
12	1,75	110	25	9	7	3	10,3	
14	2	110	28	11	9	3	12	
16	2	110	28	12	9	3	14	
18	2,5	125	33	14	11	4	15,5	
20	2,5	140	33	16	12	4	17,5	
22	2,5	140	33	18	14,5	4	19,5	
24	3	160	39	18	14,5	4	21	
27	3	160	39	20	16	4	24	
30	3,5	180	46	22	18	4	26,5	
33	3,5	180	46	25	20	4	29,5	
36	4	200	50	28	22	4	32	
39	4	200	50	32	24	4	35	
42	4,5	200	55	32	24	5	37,5	
45	4,5	220	60	36	29	5	40,5	
48	5	250	65	36	29	5	43	
52	5	250	65	40	32	5	47	

■ = Acciaio HSS / HSS Steel / Acier HSS

E25M...	CODICE - CODE		
	E25M...V	E25M...T	E25M...TXC
○	○	○	-
○	○	○	-
●	○	○	-
●	●	●	●
●	●	●	●
○	○	○	○
●	●	●	●
●	●	●	●
●	○	○	○
●	○	○	○
●	○	○	○
●	○	○	○
○	○	○	○
○	○	○	○
○	○	○	○
○	○	○	○
○	○	○	○
○	○	○	○
○	○	○	○
○	○	○	○
○	○	○	○

M Filettatura metrica ISO passo grosso DIN 13

ISO Metric coarse thread DIN 13

Metrisches ISO-Regelgewinde DIN13 – Maschinengewindebohrer

Filetage métrique ISO DIN 13 – Tarauds machine

Rosca ISO métrica regular DIN13 – Machos de rosca a máquina

N

USO GENERALE

General purpose - Usage Général

MASCHI A MACCHINA, FILETTATURA SINISTRA

LEFT THREAD MACHINE TAPS - TARAUDS MACHINE GAUCHE

DIN 371

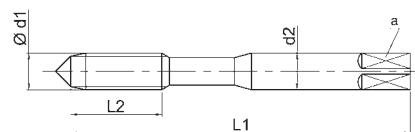

DIN 376

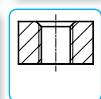
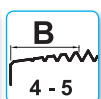
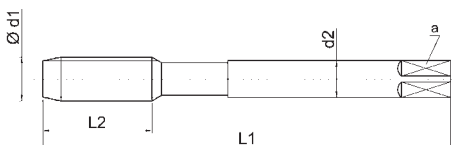

LINE



LINE



LINE



Profond. di filettatura - Thread depth - Profond. de filetage

Materiale - Material - Matériau

Tolleranza - Tolerance - Tolérance

Trattamento superficiale - Surface treatment - Revêtement

Numero gruppi materiali

Material's groups number

Nombre de groupes du matériau

3xD

HSSE

ISO2/6H

BR

1.1 1.2 1.3 1.4

4.1 4.2

5.1 5.2

3xD

HSSE

ISO2/6H

V

1.1 1.2 1.3 1.4

4.1 4.2

5.1 5.2

6.1 7.1

3xD

HSSE

ISO2/6H

TiN

1.1 1.2 1.3 1.4

3.3 3.4

4.1 4.2 4.3

5.1 5.2

DIN 371	Ød1 M	P mm	L1	L2	d2 h9	a h12	Z	
3	0,5	56	10	3,5	2,7	3	2,5	
4	0,7	63	13	4,5	3,4	3	3,3	
5	0,8	70	13	6	4,9	3	4,2	
6	1	80	16	6	4,9	3	5	
8	1,25	90	18	8	6,2	3	6,8	
10	1,5	100	20	10	8	3	8,5	

DIN 376	Ød1 M	P mm	L1	L2	d2 h9	a h12	Z	
12	1,75	110	25	9	7	3	10,3	
14	2	110	28	11	9	3	12	
16	2	110	28	12	9	3	14	
18	2,5	125	33	14	11	4	15,5	
20	2,5	140	33	16	12	4	17,5	
22	2,5	140	33	18	14,5	4	19,5	
24	3	160	39	18	14,5	4	21	
27	3	160	39	20	16	4	24	
30	3,5	180	46	22	18	4	26,5	

CODICE - CODE		
E24M...LH	E24M...LH-V	E24M...LH-T
*	*	*
○	○	○
○	○	○
●	○	○
●	○	○
●	○	○

CODICE - CODE		
E25M...LH	E25M...LH-V	E25M...LH-T
●	○	○
○	○	○
○	○	○
○	○	○
○	○	○
○	○	○
○	○	○
○	○	○

Confezione / Box / Colis:
M3 – M10: 10 pezzi / pcs
M12 – M16: 5 pezzi / pcs

€ Pag. listino - Price list - Liste des prix

12

12

12

● Standard

○ Disponibilità da richiedere, prezzo a listino
On enquiry, standard price-list / Stock à vérifier

★ Solo a richiesta
Only on request / Sur demande

N USO GENERALE
General purpose - Usage Général

MASCHI A MACCHINA
MACHINE TAPS - TARAUDS MACHINE

DIN 371

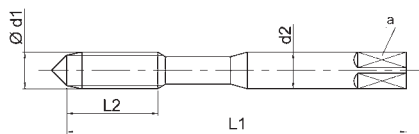

DIN 376

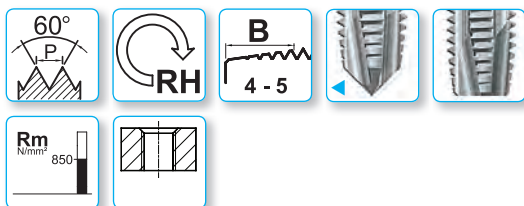
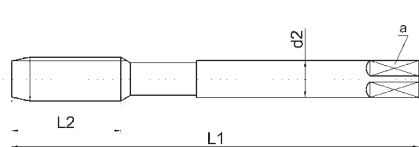

Profond. di filettatura - Thread depth - Profond. de filetage
 Materiale - Material - Matériau
 Tolleranza - Tolerance - Tolérance
 Trattamento superficiale - Surface treatment - Revêtement
 Numero gruppi materiali
 Material's groups number
 Nombre de groupes du matériau

3xD	3xD	3xD	3xD
HSSE	HSSE	HSSE	HSSE
ISO1/4H	ISO1/4H	ISO3/6G	ISO3/6G
BR	TiN	BR	TiN
1.1 1.2 1.3 1.4	1.1 1.2 1.3 1.4	1.1 1.2 1.3 1.4	1.1 1.2 1.3 1.4
4.1 4.2	3.3 3.4	4.1 4.2	3.3 3.4
5.1 5.2	4.1 4.2 4.3	5.1 5.2	4.1 4.2 4.3
	5.1 5.2		5.1 5.2

DIN 371	Ød1 M	P mm	L1	L2	d2 h9	a h12	Z	
3	0,5	56	10	3,5	2,7	3	2,5	
4	0,7	63	13	4,5	3,4	3	3,3	
5	0,8	70	13	6	4,9	3	4,2	
6	1	80	16	6	4,9	3	5	
8	1,25	90	18	8	6,2	3	6,8	
10	1,5	100	20	10	8	3	8,5	

CODICE - CODE			
E24M...-4H	E24M...T-4H	E24M...-6G	E24M...T-6G
○	○	●	○
○	○	●	○
○	○	●	○
○	○	●	○
○	○	●	○

DIN 376	Ød1 M	P mm	L1	L2	d2 h9	a h12	Z	
12	1,75	110	25	9	7	3	10,3	
14	2	110	28	11	9	3	12	
16	2	110	28	12	9	3	14	
18	2,5	125	33	14	11	4	15,5	
20	2,5	140	33	16	12	4	17,5	
22	2,5	140	33	18	14,5	4	19,5	
24	3	160	39	18	14,5	4	21	
27	3	160	39	20	16	4	24	
30	3,5	180	46	22	18	4	26,5	

CODICE - CODE			
E25M...-4H	E25M... T-4H	E25M...-6G	E25M... T-6G
○	○	●	○
○	○	○	○
○	○	●	○
○	○	○	○
○	○	○	○
○	○	○	○
○	○	○	○
○	○	○	○

Confezione / Box / Colis: M3 – M10: 10 pezzi / pcs M12 – M16: 5 pezzi / pcs
 € Pag. listino - Price list - Liste des prix
 ● Standard ○ Disponibilità da richiedere, prezzo a listino On enquiry, standard price-list / Stock à vérifier
 ● Solo a richiesta Only on request / Sur demande

M Filettatura metrica ISO passo grosso DIN 13

ISO Metric coarse thread DIN 13

Metrisches ISO-Regelgewinde DIN13 – Maschinengewindebohrer

Filetage métrique ISO DIN 13 – Tarauds machine

Rosca ISO métrica regular DIN13 – Machos de rosca a máquina



N

USO GENERALE

General purpose - Usage Général

MASCHI A MACCHINA

MACHINE TAPS - TARAUDS MACHINE

DIN 371

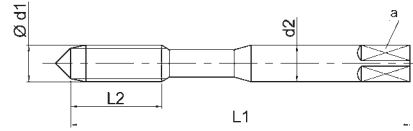

DIN 376

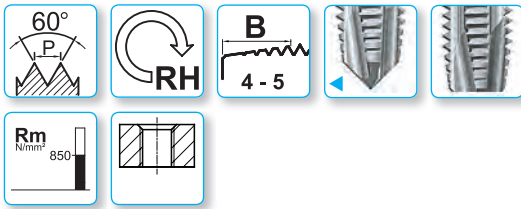
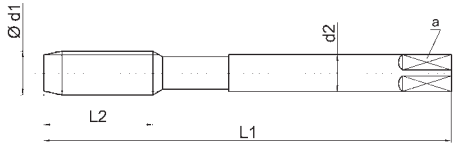

LINE



LINE



LINE



LINE



Profond. di filettatura - Thread depth - Profond. de filetage

Materiale - Material - Matériau

Tolleranza - Tolerance - Tolérance

Trattamento superficiale - Surface treatment - Revêtement

Numero gruppi materiali

Material's groups number

Nombre de groupes du matériau

3xD

3xD

3xD

3xD

HSSE

HSSE

HSSE

HSSE

7G (6H+0,05)

7G (6H+0,05)

6H+0,1

6H+0,1

BR

TiN

BR

TiN

1.1 1.2 1.3 1.4

1.1 1.2 1.3 1.4

1.1 1.2 1.3 1.4

1.1 1.2 1.3 1.4

4.1 4.2

3.3 3.4

4.1 4.2

3.3 3.4

5.1 5.2

4.1 4.2 4.3

5.1 5.2

4.1 4.2 4.3

DIN 371	Ød1 M	P mm	L1	L2	d2 h9	a h12	Z	
3	0,5	56	10	3,5	2,7	3	2,5	
4	0,7	63	13	4,5	3,4	3	3,3	
5	0,8	70	13	6	4,9	3	4,2	
6	1	80	16	6	4,9	3	5	
8	1,25	90	18	8	6,2	3	6,8	
10	1,5	100	20	10	8	3	8,5	

CODICE - CODE			
E24M...-7G	E24M...T-7G	E24M...+0,1	E24M...T+0,1
<input type="radio"/>	<input type="radio"/>	<input type="radio"/>	<input type="radio"/>
<input type="radio"/>	<input type="radio"/>	<input type="radio"/>	<input type="radio"/>
<input type="radio"/>	<input type="radio"/>	<input type="radio"/>	<input type="radio"/>
<input type="radio"/>	<input type="radio"/>	<input checked="" type="radio"/>	<input type="radio"/>
<input type="radio"/>	<input type="radio"/>	<input checked="" type="radio"/>	<input type="radio"/>
<input type="radio"/>	<input type="radio"/>	<input checked="" type="radio"/>	<input type="radio"/>

DIN 376	Ød1 M	P mm	L1	L2	d2 h9	a h12	Z	
12	1,75	110	25	9	7	3	10,3	
14	2	110	28	11	9	3	12	
16	2	110	28	12	9	3	14	
18	2,5	125	33	14	11	4	15,5	
20	2,5	140	33	16	12	4	17,5	
22	2,5	140	33	18	14,5	4	19,5	
24	3	160	39	18	14,5	4	21	
27	3	160	39	20	16	4	24	
30	3,5	180	46	22	18	4	26,5	

CODICE - CODE			
E25M...-7G	E25M...T-7G	E25M...+0,1	E25M... T+0,1
<input type="radio"/>	<input type="radio"/>	<input checked="" type="radio"/>	<input type="radio"/>
<input type="radio"/>	<input type="radio"/>	<input checked="" type="radio"/>	<input type="radio"/>
<input type="radio"/>	<input type="radio"/>	<input checked="" type="radio"/>	<input type="radio"/>
<input type="radio"/>	<input type="radio"/>	<input type="radio"/>	<input type="radio"/>
<input type="radio"/>	<input type="radio"/>	<input type="radio"/>	<input type="radio"/>
<input type="radio"/>	<input type="radio"/>	<input type="radio"/>	<input type="radio"/>
<input type="radio"/>	<input type="radio"/>	<input type="radio"/>	<input type="radio"/>
<input type="radio"/>	<input type="radio"/>	<input type="radio"/>	<input type="radio"/>

Confezione / Box / Colis:
M3 – M10: 10 pezzi / pcs
M12 – M16: 5 pezzi / pcs

€ Pag. listino - Price list - Liste des prix

13

13

14

14

● Standard

○ Disponibilità da richiedere, prezzo a listino
On enquiry, standard price-list / Stock à vérifier★ Solo a richiesta
Only on request / Sur demande

N USO GENERALE
General purpose - Usage Général

MASCHI A MACCHINA
MACHINE TAPS - TARAUDS MACHINE

UFS norm

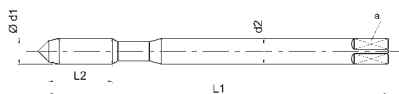

UFS norm

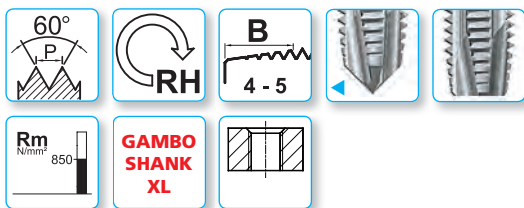
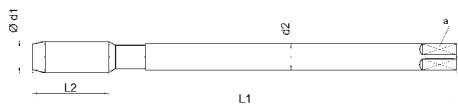

LINE



LINE



Profond. di filettatura - Thread depth - Profond. de filetage

Materiale - Material - Matériau

Tolleranza - Tolerance - Tolérance

Trattamento superficiale - Surface treatment - Revêtement

Numero gruppi materiali

Material's groups number

Nombre de groupes du matériau

3xD

3xD

HSSE

HSSE

ISO2/6H

ISO2/6H

BR

TiCN

1.1 1.2 1.3 1.4

1.1 1.2 1.3 1.4

4.1 4.2

2.1 2.2 3.3 3.4

5.1 5.2

4.2 4.3

5.2

UFS norm	Ød1 M	P mm	L ₁	L ₂	d ₂ h9	a h12	Z	
4	0,7	125	12	4,5	3,4	3	3,3	
5	0,8	140	14	6	4,9	3	4,2	
6	1	160	18	6	4,9	3	5	
8	1,25	180	20	8	6,2	3	6,8	
10	1,5	180	20	10	8	3	8,5	

CODICE - CODE
L24M... L24M...CT

<input type="radio"/>	<input type="radio"/>
<input type="radio"/>	<input type="radio"/>
<input type="radio"/>	<input type="radio"/>
<input type="radio"/>	<input type="radio"/>
<input type="radio"/>	<input type="radio"/>

UFS norm	Ød1 M	P mm	L ₁	L ₂	d ₂ h9	a h12	Z	
12	1,75	225	24	9	7	3	10,3	
14	2	225	26	11	9	3	12	
16	2	225	32	12	9	3	14	

CODICE - CODE
L25M... L25M...CT

<input type="radio"/>	<input type="radio"/>
<input type="radio"/>	<input type="radio"/>
<input type="radio"/>	<input type="radio"/>

Confezione / Box / Colis:
M3 – M10: 10 pezzi / pcs
M12 – M16: 5 pezzi / pcs

€ Pag. listino - Price list - Liste des prix

14

14

● Standard

○ Disponibilità da richiedere, prezzo a listino
On enquiry, standard price-list / Stock à vérifier

★ Solo a richiesta
Only on request / Sur demande

M Filettatura metrica ISO passo grosso DIN 13

ISO Metric coarse thread DIN 13
Metrisches ISO-Regelgewinde DIN13 – Maschinengewindebohrer
Filetage métrique ISO DIN 13 – Tarauds machine
Rosca ISO métrica regular DIN13 – Machos de rosca a máquina



MASCHI A MACCHINA

MACHINE TAPS - TARAUDS MACHINE

Al-Cu-Fe

ALLUMINIO, RAME, ACCIAIO R ≤ 700 N/mm²
Al, Cu, Steel R ≤ 700 N/mm² - Al, Cu, Acier R ≤ 700 N/mm²

DIN 371

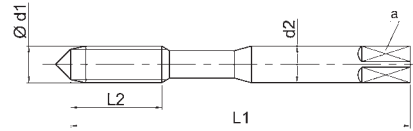

DIN 376

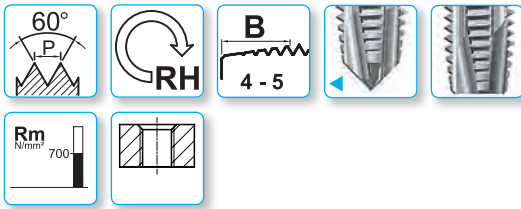
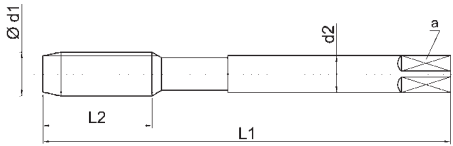

LINE



LINE



TOP



LINE



Profond. di filettatura - Thread depth - Profond. de filetage

Materiale - Material - Matériau

Tolleranza - Tolerance - Tolérance

Trattamento superficiale - Surface treatment - Revêtement

Numero gruppi materiali
Material's groups number
Nombre de groupes du matériau

3xD	3xD	3xD	3xD
HSSE	HSSE	HSSE	HSSE
ISO2/6H	ISO2/6H	ISO2/6H	ISO2/6H
BR	VS	TXC	ZrN
1.1 4.1 4.2	1.1	1.1	1.1 1.2 1.3 1.4
5.1 5.2	4.1 4.2	4.1 4.2 4.3	2.1 2.2 3.3 3.4
6.1 7.1	5.1 5.2	5.1 5.2	4.2 4.3
8.1	8.1		5.2

DIN 371	Ød1 M	P mm	L ₁	L ₂	d ₂ h ₉	a h ₁₂	Z	
◀	3	0,5	56	10	3,5	2,7	2	2,5
◀	4	0,7	63	13	4,5	3,4	2	3,3
◀	5	0,8	70	13	6	4,9	2	4,2
◀	6	1	80	16	6	4,9	2	5
◀	8	1,25	90	18	8	6,2	2	6,8
◀	10	1,5	100	20	10	8	2	8,5
◀	3	0,5	56	10	3,5	2,7	3	2,5
◀	4	0,7	63	13	4,5	3,4	3	3,3
◀	5	0,8	70	13	6	4,9	3	4,2
◀	6	1	80	16	6	4,9	3	5
◀	8	1,25	90	18	8	6,2	3	6,8
◀	10	1,5	100	20	10	8	3	8,5

CODICE - CODE			
E24M...AL	E24M...AL-VS	E24M...AL-TXC	
○	○	○	
○	○	○	
○	○	○	
○	○	○	
○	○	○	
○	○	○	
-	-	-	*E24M...TZ
-	-	-	○
-	-	-	○
-	-	-	○
-	-	-	○
-	-	-	○

DIN 376	Ød1 M	P mm	L ₁	L ₂	d ₂ h ₉	a h ₁₂	Z	
	12	1,75	110	25	9	7	3	10,3
	14	2	110	28	11	9	3	12
	16	2	110	28	12	9	3	14

CODICE - CODE			
E25M...AL	E25M...AL-VS	E25M...AL-TXC	*E25M...TZ
○	○	○	○
○	○	○	○
○	○	○	○

* In alternativa si consiglia:
Alternatively we recommend:
Par ailleurs, nous vous recommandons:
E24M...TXC - pag. 20
E25M...TXC - pag. 21

Confezione / Box / Colis:
M3 – M10: 10 pezzi / pcs
M12 – M16: 5 pezzi / pcs

€ Pag. listino - Price list - Liste des prix
● Standard

14

○ Disponibilità da richiedere, prezzo a listino
On enquiry, standard price-list / Stock à vérifier

14

15

★ Solo a richiesta
Only on request / Sur demande

15

Al-Cu-Fe

ALLUMINIO, RAME, ACCIAIO R ≤ 700 N/mm²

Al, Cu, Steel R≤700 N/mm² - Al, Cu, Acier R≤700 N/mm²

MASCHI A MACCHINA

MACHINE TAPS - TARAUDS MACHINE

DIN 371

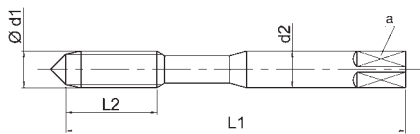

DIN 376

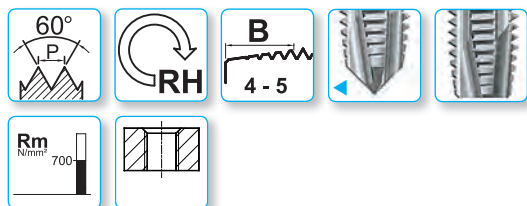
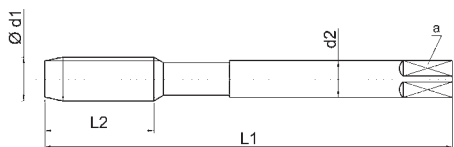

LINE



TOP



LINE



LINE



Profond. di filettatura - Thread depth - Profond. de filetage

Materiale - Material - Matériau

Tolleranza - Tolerance - Tolérance

Trattamento superficiale - Surface treatment - Revêtement

Numero gruppi materiali

Material's groups number

Nombre de groupes du matériau

3xD	3xD	3xD	3xD
HSSE	HSSE	HSSE	HSSE
ISO2/6H	ISO2/6H	ISO2/6H	ISO2/6H
BR	TXC	ZrN	CrN
1.1 4.1 4.2	1.1	1.1	1.1 1.2 1.3 1.4
5.1 5.2	4.1 4.2	4.1 4.2	5.1 5.2
6.1 7.1	5.1 5.2	5.1 5.2	
8.1			

DIN 371	Ød1 M	P mm	L1	L2	d2 h9	a h12	Z	
3	0,5	56	10	3,5	2,7	3	2,5	
4	0,7	63	13	4,5	3,4	3	3,3	
5	0,8	70	13	6	4,9	3	4,2	
6	1	80	16	6	4,9	3	5	
8	1,25	90	18	8	6,2	3	6,8	
10	1,5	100	20	10	8	3	8,5	

CODICE - CODE			
E24M...AZ	E24M...AZ-TXC	E24M...AZ-TZ	E24M...NC
○	○	○	○
●	○	○	○
●	○	○	○
●	○	○	○
●	○	○	○
●	○	○	○

DIN 376	Ød1 M	P mm	L1	L2	d2 h9	a h12	Z	
12	1,75	110	25	9	7	3	10,3	
14	2	110	28	11	9	3	12	
16	2	110	28	12	9	3	14	
18	2,5	125	33	14	11	4	15,5	
20	2,5	140	33	16	12	4	17,5	
22	2,5	140	33	18	14,5	4	19,5	
24	3	160	39	18	14,5	4	21	
27	3	160	39	20	16	4	24	
30	3,5	180	46	22	18	4	26,5	

CODICE - CODE			
E25M...AZ	E25M...AZ-TXC	E25M...AZ-TZ	E25M...NC
●	○	○	○
●	○	○	○
●	○	○	○
*	*	-	○
*	*	-	○
*	*	-	○
*	*	-	○
*	*	-	○

Confezione / Box / Collis:
M3 – M10: 10 pezzi / pcs
M12 – M16: 5 pezzi / pcs

€ Pag. listino - Price list - Liste des prix

● Standard

○ Disponibilità da richiedere, prezzo a listino
On enquiry, standard price-list / Stock à vérifier

* Solo a richiesta
Only on request / Sur demande

Filettatura metrica ISO passo grosso DIN 13

ISO Metric coarse thread DIN 13

Metrisches ISO-Regelgewinde DIN13 – Maschinengewindebohrer

Filetage métrique ISO DIN 13 – Tarauds machine

Rosca ISO métrica regular DIN13 – Machos de rosca a máquina

N

USO GENERALE R ≤ 1000N/mm²General purpose R ≤ 1000N/mm² - Usage Général R ≤ 1000N/mm²

MASCHI A MACCHINA

MACHINE TAPS - TARAUDS MACHINE

DIN 371

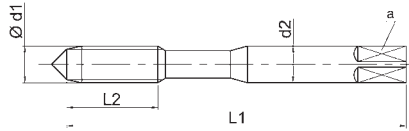

DIN 376

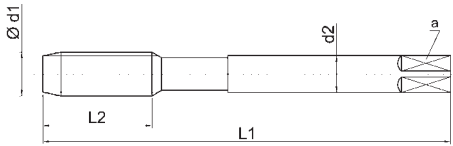

Profond. di filettatura - Thread depth - Profond. de filetage

Materiale - Material - Matériau

Tolleranza - Tolerance - Tolérance

Trattamento superficiale - Surface treatment - Revêtement

Numero gruppi materiali

Material's groups number

Nombre de groupes du matériau

3xD	3xD	3xD	3xD
HSSP	HSSP	HSSP	HSSP
ISO2/6H	ISO2/6H	ISO2/6H	ISO2/6H
BR	V	TiN	TiCN
1.1 1.2 1.3 1.4	1.1 1.2 1.3 1.4	1.1 1.2 1.3 1.4 1.5	1.1 1.2 1.3 1.4 1.5
4.1 4.2	4.1 4.2	3.3 3.4 4.1 4.2 4.3	2.1 2.2
5.1 5.2	5.1 5.2	5.1 5.2	3.3 3.4 4.2 4.3
	6.1 7.1		5.2

DIN 371	Ød1 M	P mm	L1	L2	d2 h9	a h12	Z	
3	0,5	56	10	3,5	2,7	3	2,5	
4	0,7	63	13	4,5	3,4	3	3,3	
5	0,8	70	13	6	4,9	3	4,2	
6	1	80	16	6	4,9	3	5	
8	1,25	90	18	8	6,2	3	6,8	
10	1,5	100	20	10	8	3	8,5	

CODICE - CODE			
P24M...	P24M... V	P24M...T	P24M...CT
*	*	*	*
o	o	o	o
o	o	o	o
o	o	o	o
o	o	o	o
o	o	o	o

DIN 376	Ød1 M	P mm	L1	L2	d2 h9	a h12	Z	
12	1,75	110	25	9	7	4	10,3	
14	2	110	28	11	9	4	12	
16	2	110	28	12	9	4	14	
18	2,5	125	33	14	11	4	15,5	
20	2,5	140	33	16	12	4	17,5	
22	2,5	140	33	18	14,5	4	19,5	
24	3	160	39	18	14,5	4	21	
27	3	160	39	20	16	4	24	
30	3,5	180	46	22	18	4	26,5	

CODICE - CODE			
P25M...	P25M... V	P25M...T	P25M...CT
o	o	o	o
*	*	*	*
*	*	*	*
*	*	*	*
*	*	*	*
*	*	*	*
*	*	*	*
*	*	*	*



Solo a richiesta
Only on request / Sur demande

Confezione / Box / Colis:
M3 – M10: 10 pezzi / pcs
M12 – M16: 5 pezzi / pcs

€ Pag. listino - Price list - Liste des prix

16

16

16

16

• Standard

o Disponibilità da richiedere, prezzo a listino
On enquiry, standard price-list / Stock à vérifier

U **APPLICAZIONI UNIVERSALI R ≤ 1200 N/mm²**
 Universal R ≤ 1200 N/mm² - Universal R ≤ 1200 N/mm²

MASCHI A MACCHINA
 MACHINE TAPS - TARAUDS MACHINE

DIN 371

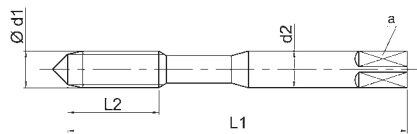

DIN 376

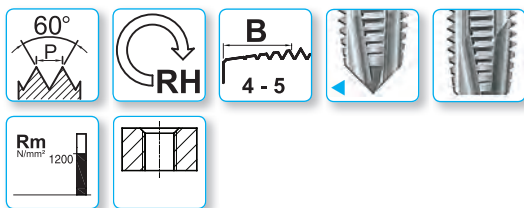
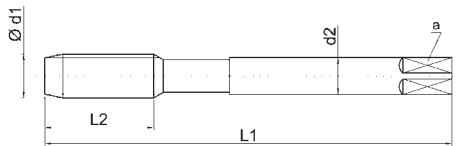

TOP



TOP



- Profond. di filettatura - Thread depth - Profond. de filetage
- Materiale - Material - Matériau
- Tolleranza - Tolerance - Tolérance
- Trattamento superficiale - Surface treatment - Revêtement
- Numero gruppi materiali
 Material's groups number
 Nombre de groupes du matériau

3xD	3,5xD
PM3	PM3
6HX	6HX
XP	XP
1.1 1.2 1.3 1.4 1.5	1.1 1.2 1.3 1.4 1.5
2.1 2.2 2.3	2.1 2.2 2.3
3.3 3.4 4.2 4.3	3.3 3.4 4.2 4.3
5.2	5.2

DIN 371	Ød1 M	P mm	L1	L2	d2 h9	a h12	Z	
3	0,5	56	10	3,5	2,7	3	2,5	
4	0,7	63	13	4,5	3,4	3	3,3	
5	0,8	70	13	6	4,9	3	4,2	
6	1	80	16	6	4,9	3	5	
8	1,25	90	18	8	6,2	3	6,8	
10	1,5	100	20	10	8	3	8,5	

CODICE - CODE	
K24M...XP	K24M...FORY-XP
●	-
●	-
●	-
●	○
●	○
●	○
●	○
●	○
●	○
●	○

DIN 376	Ød1 M	P mm	L1	L2	d2 h9	a h12	Z	
12	1,75	110	25	9	7	4	10,3	
14	2	110	28	11	9	4	12	
16	2	110	28	12	9	4	14	
18	2,5	125	33	14	11	4	15,5	
20	2,5	140	33	16	12	4	17,5	
22	2,5	140	33	18	14,5	4	19,5	
24	3	160	39	18	14,5	4	21	

CODICE - CODE	
K25M...XP	K25M...FORY-XP
●	○
●	○
●	○
○	○
○	○
○	○
○	○
○	○

Filettatura metrica ISO passo grosso DIN 13

ISO Metric coarse thread DIN 13

Metrisches ISO-Regelgewinde DIN13 – Maschinengewindebohrer

Filetage métrique ISO DIN 13 – Tarauds machine

Rosca ISO métrica regular DIN13 – Machos de roscar a máquina

**SYNCHRO
RIGID**

MASCHIATURA RIGIDA SINCRONIZZATA

Rigid Tapping Synchro - Taraudage rigide synchronisé

MASCHI A MACCHINA

MACHINE TAPS - TARAUDS MACHINE

**DIN
371**

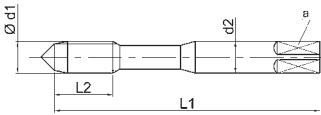

**DIN
371**

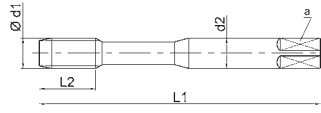

**UFS
norm**

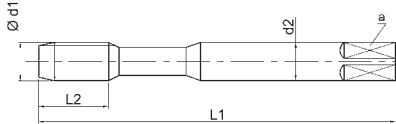

Profond. di filettatura - Thread depth - Profond. de filetage

Materiale - Material - Matériau

Tolleranza - Tolerance - Tolérance

Trattamento superficiale - Surface treatment - Revêtement

Numero gruppi materiali

Material's groups number

Nombre de groupes du matériau

TOP



TOP



3xD

3,5xD

PM3

PM3

6HX

6HX

TXC

TXC

1.1	1.2	1.3	1.4	1.5	1.1	1.2	1.3	1.4	1.5		
2.1	2.2	2.3	2.4	3.3	3.4	2.1	2.2	2.3	2.4	3.3	3.4
4.1	4.2	4.3	4.5	4.6	5.1	4.1	4.2	4.3	4.5	4.6	5.1
5.2	5.3	6.1	6.2	7.1	7.2	5.2	5.3	6.1	6.2	7.1	7.2

DIN 371	Ød1 M	P mm	L1	L2 10xP	d2 h6	a h12	Z	
6	1	80	10	6	4,9	3	5	
8	1,25	90	13	8	6,2	3	6,8	
10	1,5	100	15	10	8	3	8,5	

CODICE - CODE	
S24M...TXC	S24M...FORY-TXC
○	○
○	○
○	○

UFS norm	Ød1 M	P mm	L1	L2 10xP	d2 h6	a h12	Z	
12	1,75	110	18	12	9	3	10,3	
14	2	110	20	12	9	3	12	
16	2	110	20	16	12	4	14	

CODICE - CODE	
S24M...TXC	S24M...FORY-TXC
○	○
○	○
○	○

A richiesta:
On request:
Sur demande:
Con **Weldon** DIN1835 B

Confezione / Box / Colis:
M3 – M10: 10 pezzi / pcs
M12 – M16: 5 pezzi / pcs

€ Pag. listino - Price list - Liste des prix

17

17

● Standard

○ Disponibilità da richiedere, prezzo a listino
On enquiry, standard price-list / Stock à vérifier

★ Solo a richiesta
Only on request / Sur demande

HR ALTA RESISTENZA
High Resistance - Haute Résistance

MASCHI A MACCHINA
MACHINE TAPS - TARAUDS MACHINE

DIN 371

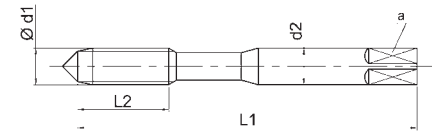

DIN 376

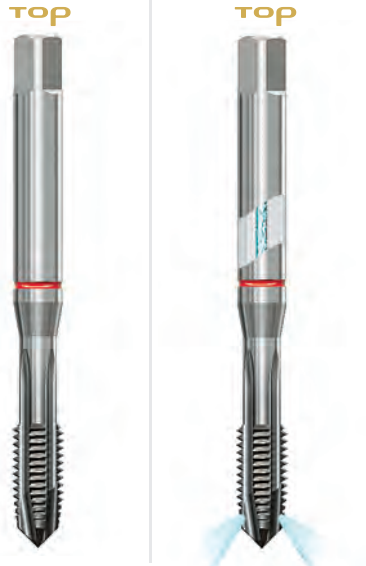
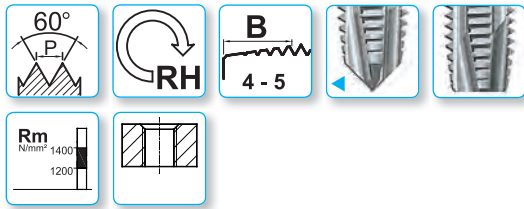
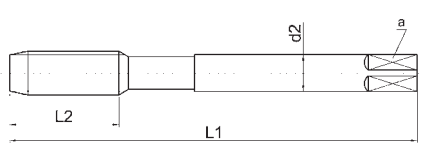

Profond. di filettatura - Thread depth - Profond. de filetage
 Materiale - Material - Matériau
 Tolleranza - Tolerance - Tolérance
 Trattamento superficiale - Surface treatment - Revêtement
 Numero gruppi materiali
 Material's groups number
 Nombre de groupes du matériau

3xD	3,5xD
PM3	PM3
6HX	6HX
TXC	TXC
1.5 1.6	1.5 1.6
3.3 3.4	3.3 3.4
4.4 5.3	4.4 5.3

DIN 371	Ød1 M	P mm	L ₁	L ₂	d ₂ h ₉	a h ₁₂	Z	
3	0,5	56	10	3,5	2,7	3	2,5	
4	0,7	63	13	4,5	3,4	3	3,3	
5	0,8	70	13	6	4,9	3	4,2	
6	1	80	16	6	4,9	3	5	
8	1,25	90	18	8	6,2	3	6,8	
10	1,5	100	20	10	8	3	8,5	

CODICE - CODE	
K24M...TXC	K24M...FORY-TXC
•	-
•	-
•	-
•	○
•	○
•	○

DIN 376	Ød1 M	P mm	L ₁	L ₂	d ₂ h ₉	a h ₁₂	Z	
12	1,75	110	25	9	7	4	10,3	
14	2	110	28	11	9	4	12	
16	2	110	28	12	9	4	14	

CODICE - CODE	
K25M...TXC	K25M...FORY-TXC
•	○
•	○
•	○

Filettatura metrica ISO passo grosso DIN 13**ISO Metric coarse thread DIN 13**

Metrisches ISO-Regelgewinde DIN13 – Maschinengewindebohrer

Filetage métrique ISO DIN 13 – Tarauds machine

Rosca ISO métrica regular DIN13 – Machos de rosca a máquina

INOX**ACCIAIO INOSSIDABILE**
Stainless steel - Acier inoxydable**MASCHI A MACCHINA**

MACHINE TAPS - TARAUDS MACHINE

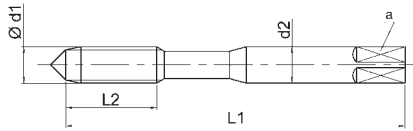
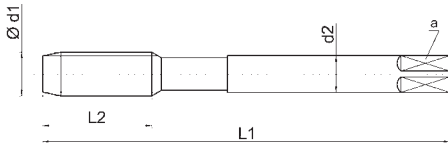
DIN 371**DIN 376**

Profond. di filettatura - Thread depth - Profond. de filetage

Materiale - Material - Matériau

Tolleranza - Tolerance - Tolérance

Trattamento superficiale - Surface treatment - Revêtement

Numero gruppi materiali

Material's groups number

Nombre de groupes du matériau

LINE



TOP



TOP



TOP



3xD

HSSV3

6HX

V

2.1 2.2 2.3

3xD

HSSV3

6HX

TXC

1.3 1.4 1.5

2.1 2.2 2.3 2.4

3xD

PM3

6HX

TXC

1.3 1.4 1.5

2.1 2.2 2.3 2.4

3,5xD

PM3

6HX

TXC

1.3 1.4 1.5

2.1 2.2 2.3 2.4

DIN 371	Ød1 M	P mm	L1	L2	d2 h9	a h12	Z	
◀	3	0,5	56	10	3,5	2,7	3	2,5
◀	4	0,7	63	13	4,5	3,4	3	3,3
◀	5	0,8	70	13	6	4,9	3	4,2
◀	6	1	80	16	6	4,9	3	5
◀	8	1,25	90	18	8	6,2	3	6,8
◀	10	1,5	100	20	10	8	3	8,5

E24M...X-V	CODICE - CODE		
	V24M...TXC	K24M...X-TXC	K24M...XFORY-TXC
○	●	○	-
○	●	○	-
○	●	○	-
○	●	○	○
○	●	○	○
○	●	○	○

DIN 376	Ød1 M	P mm	L1	L2	d2 h9	a h12	Z	
	12	1,75	110	25	9	7	4	10,3
	14	2	110	28	11	9	4	12
	16	2	110	28	12	9	4	14
	18	2,5	125	33	14	11	4	15,5
	20	2,5	140	33	16	12	4	17,5
	22	2,5	140	33	18	14,5	4	19,5
	24	3	160	39	18	14,5	4	21

E25M...X-V	CODICE - CODE		
	V25M...TXC	K25M...X-TXC	K25M...XFORY-TXC
○	●	○	○
○	●	○	○
○	●	○	○
○	○	-	-
○	○	-	-
○	○	-	-
○	○	-	-

Confezione / Box / Colis:
M3 – M10: 10 pezzi / pcs
M12 – M16: 5 pezzi / pcs

€ Pag. listino - Price list - Liste des prix

18

18

18

18

● Standard

○ Disponibilità da richiedere, prezzo a listino
On enquiry, standard price-list / Stock à vérifier★ Solo a richiesta
Only on request / Sur demande

N **USO GENERALE**
General purpose - Usage Général

MASCHI A MACCHINA
MACHINE TAPS - TARAUDS MACHINE

DIN 371

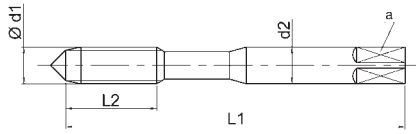

DIN 376

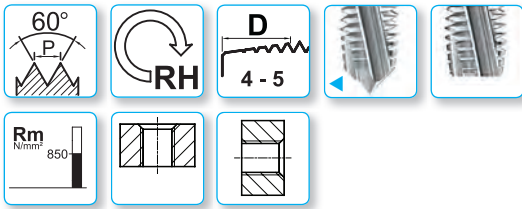
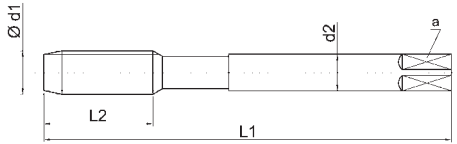

LINE



L15°

LINE



L15°

LINE



L15°

Profond. di filettatura - Thread depth - Profond. de filetage

Materiale - Material - Matériau

Tolleranza - Tolerance - Tolérance

Trattamento superficiale - Surface treatment - Revêtement

Numero gruppi materiali

Material's groups number

Nombre de groupes du matériau

3xD	3xD	3xD
HSSE	HSSE	HSSE
ISO2/6H	ISO2/6H	ISO2/6H
BR	V	XP
1.1 1.2 1.3 1.4	1.1 1.2 1.3 1.4	1.1 1.2 1.3 1.4
	4.2 5.2	3.3 3.4
	6.1 7.1	4.3 5.2

DIN 371	Ød1 M	P mm	L1	L2	d2 h9	a h12	Z	
3	0,5	56	10	3,5	2,7	3	2,5	
4	0,7	63	13	4,5	3,4	3	3,3	
5	0,8	70	13	6	4,9	3	4,2	
6	1	80	16	6	4,9	3	5	
8	1,25	90	18	8	6,2	3	6,8	
10	1,5	100	20	10	8	3	8,5	

CODICE - CODE		
E50M...	E50M...V	E50M...XP
●	○	○
●	○	○
●	○	○
●	○	○
●	○	○
●	○	○

DIN 376	Ød1 M	P mm	L1	L2	d2 h9	a h12	Z	
12	1,75	110	25	9	7	3	10,3	
14	2	110	28	11	9	3	12	
16	2	110	28	12	9	3	14	
18	2,5	125	33	14	11	4	15,5	
20	2,5	140	33	16	12	4	17,5	
22	2,5	140	33	18	14,5	4	19,5	
24	3	160	39	18	14,5	4	21	
27	3	160	39	20	16	4	24	
30	3,5	180	46	22	18	4	26,5	

CODICE - CODE		
E51M...	E51M...V	E51M...XP
●	○	○
●	○	○
●	○	○
*	*	*
*	*	*
*	*	*
*	*	*
*	*	*
*	*	*

Da usare in alternativa ai maschi con imbocco corretto per fori profondi specialmente in filettatura orizzontale.
To be used with deep holes, specially in horizontal threading.
À utiliser en alternative aux tarauds entrée GUN pour trous profonds. Particulièrement pour les taraudages horizontaux.

Confezione / Box / Colis: M3 – M10: 10 pezzi / pcs M12 – M16: 5 pezzi / pcs	€ Pag. listino - Price list - Liste des prix	18-19	19	19
	● Standard	○ Disponibilità da richiedere, prezzo a listino On enquiry, standard price-list / Stock à vérifier	★ Solo a richiesta Only on request / Sur demande	

M Filettatura metrica ISO passo grosso DIN 13

ISO Metric coarse thread DIN 13

Metrisches ISO-Regelgewinde DIN13 – Maschinengewindebohrer

Filetage métrique ISO DIN 13 – Tarauds machine

Rosca ISO métrica regular DIN13 – Machos de rosca a máquina



Ti

TITANIO

Titanium - Titane

MASCHI A MACCHINA

MACHINE TAPS - TARAUDS MACHINE

DIN 371

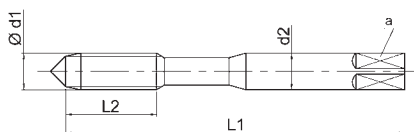

DIN 376

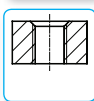
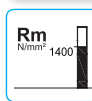
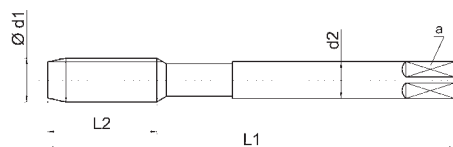

TOP



L15°

TOP



L15°

TOP



L15°

TOP



L15°



Profond. di filettatura - Thread depth - Profond. de filetage

Materiale - Material - Matériau

Tolleranza - Tolerance - Tolérance

Trattamento superficiale - Surface treatment - Revêtement

Numero gruppi materiali

Material's groups number

Nombre de groupes du matériau

3xD

3xD

3xD

3xD

PM3

PM3

PM3

PM3

6HX

6HX

4H

4H

V

TiCN

V

TiCN

6.1

1.6 2.4

6.1

1.6 2.4

3.3 3.4

3.3 3.4

4.4 5.3 5.4 6.2 6.3

4.4 5.3 5.4 6.2 6.3

7.2 9.2

7.2 9.2

DIN 371	Ød1 M	P mm	L1	L2	d2 h9	a h12	Z	
3	0,5	56	10	3,5	2,7	3	*2,5	
4	0,7	63	13	4,5	3,4	3	*3,3	
5	0,8	70	13	6	4,9	3	*4,2	
6	1	80	16	6	4,9	3	*5	
8	1,25	90	18	8	6,2	3	*6,8	
10	1,5	100	20	10	8	3	*8,5	

CODICE - CODE			
K52M...V	K52M...CT	K52MJ...V	K52MJ...CT
<input type="radio"/>	<input type="radio"/>	<input type="radio"/>	<input type="radio"/>
<input type="radio"/>	<input type="radio"/>	<input type="radio"/>	<input type="radio"/>
<input type="radio"/>	<input type="radio"/>	<input type="radio"/>	<input type="radio"/>
<input type="radio"/>	<input type="radio"/>	<input type="radio"/>	<input type="radio"/>
<input type="radio"/>	<input type="radio"/>	<input type="radio"/>	<input type="radio"/>

DIN 376	Ød1 M	P mm	L1	L2	d2 h9	a h12	Z	
12	1,75	110	25	9	7	3	*10,3	
16	2	110	28	12	9	3	*14	

CODICE - CODE			
K53M...V	K53M...CT	K53MJ...V	K53MJ...CT
<input type="radio"/>	<input type="radio"/>	<input type="radio"/>	<input type="radio"/>
<input type="radio"/>	<input type="radio"/>	<input type="radio"/>	<input type="radio"/>

* Per MJ vedi tabella di foratura pag. 252

* Drills' diameters for MJ: table page 252

* Pour MJ voir le tableau de perçage page 252

Confezione / Box / Colis:
M3 – M10: 10 pezzi / pcs
M12 – M16: 5 pezzi / pcs

€ Pag. listino - Price list - Liste des prix

19

19

19

19

● Standard

○ Disponibilità da richiedere, prezzo a listino
On enquiry, standard price-list / Stock à vérifier

★ Solo a richiesta
Only on request / Sur demande

Ni

NICHEL

Nickel - Nickel

MASCHI A MACCHINA

MACHINE TAPS - TARAUDS MACHINE

UFS norm

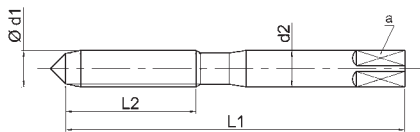

UFS norm

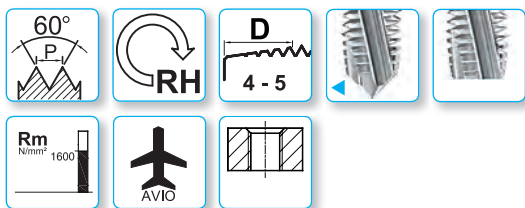
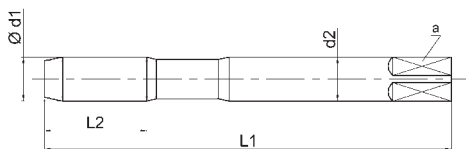

TOP



L10°

TOP



L10°

TOP



L10°

Profond. di filettatura - Thread depth - Profond. de filetage

Materiale - Material - Matériau

Tolleranza - Tolerance - Tolérance

Trattamento superficiale - Surface treatment - Revêtement

Numero gruppi materiali

Material's groups number

Nombre de groupes du matériau

3xD	3xD	3xD
PM3	PM3	PM3
6HX	6HX	4HX
BR	TiCN	BR
7.3 9.3	1.6 5.4	7.3 9.3
	7.2 9.1	

UFS norm	Ød1 M	P mm	L1	L2	d2 h9	a h12	Z	
3	0,5	56	10	3,5	2,7	3	*2,5	
4	0,7	63	13	4,5	3,4	3	*3,3	
5	0,8	70	15	6	4,9	3	*4,2	
6	1	80	18	6	4,9	3	*5	
8	1,25	90	25	8	6,2	3	*6,8	
10	1,5	100	30	10	8	3	*8,5	

K52M...NI	CODICE - CODE	
	K52M...NI-CT	K52M...NI-4HX
○	○	○
○	○	○
○	○	○
○	○	○
○	○	○
○	○	○

UFS norm	Ød1 M	P mm	L1	L2	d2 h9	a h12	Z	
12	1,75	110	30	12	9	3	*10,3	

K52M...NI	CODICE - CODE	
	K52M...NI-CT	K52M... NI-4HX
○	○	○

* Per MJ vedi tabella di foratura pag. 252
 * Drills' diameters for MJ: table page 252
 * Pour MJ voir le tableau de perçage page 252

M Filettatura metrica ISO passo grosso DIN 13

ISO Metric coarse thread DIN 13

Metrisches ISO-Regelgewinde DIN13 – Maschinengewindebohrer

Filetage métrique ISO DIN 13 – Tarauds machine

Rosca ISO métrica regular DIN13 – Machos de rosca a máquina

N

USO GENERALE

General purpose - Usage Général

MASCHI A MACCHINA

MACHINE TAPS - TARAUDS MACHINE

DIN 371

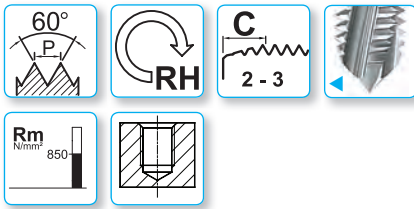
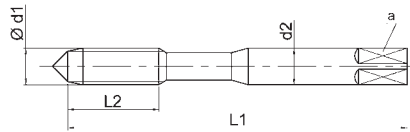

Profond. di filettatura - Thread depth - Profond. de filetage

Materiale - Material - Matériau

Tolleranza - Tolerance - Tolérance

Trattamento superficiale - Surface treatment - Revêtement

Numero gruppi materiali

Material's groups number

Nombre de groupes du matériau

1,5xD

HSSE

ISO2/6H

BR

1.1 1.2 1.3 1.4

4.1 4.2

5.1 5.2

1,5xD

HSSE

ISO2/6H

V

1.1 1.2 1.3 1.4

4.1 4.2

5.1 5.2

6.1 7.1

1,5xD

HSSE

ISO2/6H

TiN

1.1 1.2 1.3 1.4

3.3 3.4

4.1 4.2 4.3

5.1 5.2

1,5xD

HSSE

ISO2/6H

XP

1.1 1.2 1.3 1.4

3.3 3.4

4.2 4.3

5.2

DIN 371	$\varnothing d_1$ M	P mm	L ₁	L ₂	d ₂ h9	a h12	Z	
◀	2	0,4	45	10	2,8	2,1	3	1,6
◀	2,2	0,45	45	10	2,8	2,1	3	1,75
◀	2,3	0,4	45	10	2,8	2,1	3	1,9
◀	2,5	0,45	50	13	2,8	2,1	3	2,05
◀	2,6	0,45	50	13	2,8	2,1	3	2,10
◀	3	0,5	56	10	3,5	2,7	3	2,5
◀	3,5	0,6	56	11	4	3	3	2,9
◀	4	0,7	63	13	4,5	3,4	3	3,3
◀	5	0,8	70	13	6	4,9	3	4,2
◀	6	1	80	16	6	4,9	3	5
◀	7	1	80	16	7	5,5	3	6
◀	8	1,25	90	18	8	6,2	3	6,8
◀	10	1,5	100	20	10	8	3	8,5

E40M...	CODICE - CODE			E40M...XP
	E40M...V	E40M...T		
○	○	○	○	
○	○	○	○	
○	○	○	○	
○	○	○	○	
○	○	○	○	
●	●	●	●	
○	○	○	○	
●	●	●	●	
●	●	●	●	
●	●	●	●	
○	○	○	○	
●	●	●	●	
●	●	●	●	

Segue diametri
Diameters, to be continued
Diamètres à suivre

▶ Pag. 37

Confezione / Box / Colis:
M3 – M10: 10 pezzi / pcs
M12 – M16: 5 pezzi / pcs

€ Pag. listino - Price list - Liste des prix

20

20

20

20

● Standard

○ Disponibilità da richiedere, prezzo a listino
On enquiry, standard price-list / Stock à vérifier

★ Solo a richiesta
Only on request / Sur demande

N

USO GENERALE

General purpose - Usage Général

MASCHI A MACCHINA

MACHINE TAPS - TARAUDS MACHINE

DIN 376

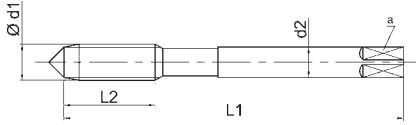

DIN 376

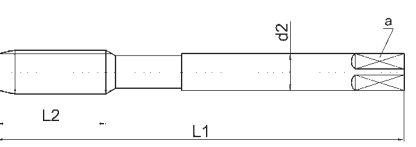

R15°



R15°



R15°



R15°

Profond. di filettatura - Thread depth - Profond. de filetage

1,5xD

1,5xD

1,5xD

1,5xD

Materiale - Material - Matériau

HSSE

HSSE

HSSE

HSSE

Tolleranza - Tolerance - Tolérance

ISO2/6H

ISO2/6H

ISO2/6H

ISO2/6H

Trattamento superficiale - Surface treatment - Revêtement

BR

V

TiN

XP

Numero gruppi materiali

Material's groups number

Nombre de groupes du matériau

1.1 1.2 1.3 1.4

4.1 4.2

5.1 5.2

1.1 1.2 1.3 1.4

4.1 4.2

5.1 5.2

6.1 7.1

1.1 1.2 1.3 1.4

3.3 3.4

4.1 4.2 4.3

5.1 5.2

1.1 1.2 1.3 1.4

3.3 3.4

4.2 4.3

5.2

DIN 376	Ød1 M	P mm	L ₁	L ₂	d ₂ h ₉	a h ₁₂	Z	Z	
◀	4	0,7	63	13	2,8	2,1	3	3,3	
◀	5	0,8	70	13	3,5	2,7	3	4,2	
◀	6	1	80	16	4,5	3,4	3	5	
◀	8	1,25	90	18	6	4,9	3	6,8	
◀	10	1,5	100	20	7	5,5	3	8,5	
	11	1,5	100	20	8	6,2	3	9,5	
	12	1,75	110	25	9	7	3	10,3	
	14	2	110	28	11	9	3	12	
	16	2	110	28	12	9	3	14	
	18	2,5	125	33	14	11	4	15,5	
	20	2,5	140	33	16	12	4	17,5	
	22	2,5	140	33	18	14,5	4	19,5	
	24	3	160	39	18	14,5	4	21	
	27	3	160	39	20	16	4	24	
	30	3,5	180	46	22	18	4	26,5	
	33	3,5	180	46	25	20	4	29,5	
	36	4	200	50	28	22	4	32	
	39	4	200	50	32	24	4	35	
	42	4,5	200	55	32	24	5	37,5	
■	45	4,5	220	60	36	29	5	40,5	
■	48	5	250	65	36	29	5	43	
■	52	5	250	65	40	32	5	47	

■ = Acciaio HSS / HSS Steel / Acier HSS

CODICE - CODE			
E41M...	E41M...V	E41M...T	E41M...XP
○	○	○	-
○	○	○	-
●	○	○	-
●	●	●	-
●	●	●	-
○	○	○	-
●	●	●	●
●	●	●	●
●	○	○	-
●	○	○	-
●	○	○	-
●	○	○	-
○	○	○	-
○	○	○	-
○	○	○	-
○	○	○	-
○	○	○	-
○	○	○	-
○	○	○	-
○	○	○	-
○	○	○	-

Confezione / Box / Colis: M3 - M10: 10 pezzi / pcs M12 - M16: 5 pezzi / pcs	€ Pag. listino - Price list - Liste des prix	21	21	21	21
	● Standard	○ Disponibilità da richiedere, prezzo a listino On enquiry, standard price-list / Stock à vérifier		★ Solo a richiesta Only on request / Sur demande	

M Filettatura metrica ISO passo grosso DIN 13

ISO Metric coarse thread DIN 13

Metrisches ISO-Regelgewinde DIN13 – Maschinengewindebohrer

Filetage métrique ISO DIN 13 – Tarauds machine

Rosca ISO métrica regular DIN13 – Machos de rosca a máquina

N

USO GENERALE

General purpose - Usage Général

MASCHI A MACCHINA

MACHINE TAPS - TARAUDS MACHINE

DIN 371

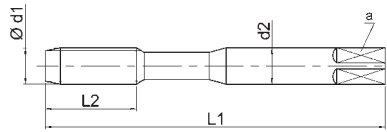

DIN 376

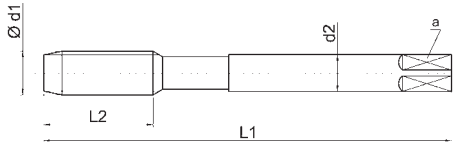

Profond. di filettatura - Thread depth - Profond. de filetage

Materiale - Material - Matériau

Tolleranza - Tolerance - Tolérance

Trattamento superficiale - Surface treatment - Revêtement

Numero gruppi materiali

Material's groups number

Nombre de groupes du matériau

LINE



R15°

2,5xD

HSSE

ISO2/6H

BR

1.1 1.2 1.3 1.4

4.1 4.2

5.1 5.2

LINE



R15°

2,5xD

HSSE

ISO2/6H

TiN

1.1 1.2 1.3 1.4

3.3 3.4

4.1 4.2 4.3

5.1 5.2

DIN 371	Ød1 M	P mm	L ₁	L ₂	d ₂ h ₉	a h ₁₂	Z	
6	1	80	16	6	4,9	3	5	
8	1,25	90	18	8	6,2	3	6,8	
10	1,5	100	20	10	8	3	8,5	

CODICE - CODE
E40M...FOR E40M...FOR-T

○

○

○

○

○

○

DIN 376	Ød1 M	P mm	L ₁	L ₂	d ₂ h ₉	a h ₁₂	Z	
12	1,75	110	25	9	7	3	10,3	
14	2	110	28	11	9	3	12	
16	2	110	28	12	9	3	14	

CODICE - CODE
E41M...FOR E41M...FOR-T

○

○

○

○

○

○

Confezione / Box / Colis:
M3 – M10: 10 pezzi / pcs
M12 – M16: 5 pezzi / pcs

€ Pag. listino - Price list - Liste des prix

21

21

• Standard

○ Disponibilità da richiedere, prezzo a listino
On enquiry, standard price-list / Stock à vérifier

★ Solo a richiesta
Only on request / Sur demande

N USO GENERALE
General purpose - Usage Général

MASCHI A MACCHINA
MACHINE TAPS - TARAUDS MACHINE

DIN 371

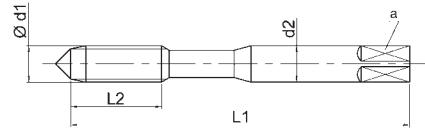

DIN 376

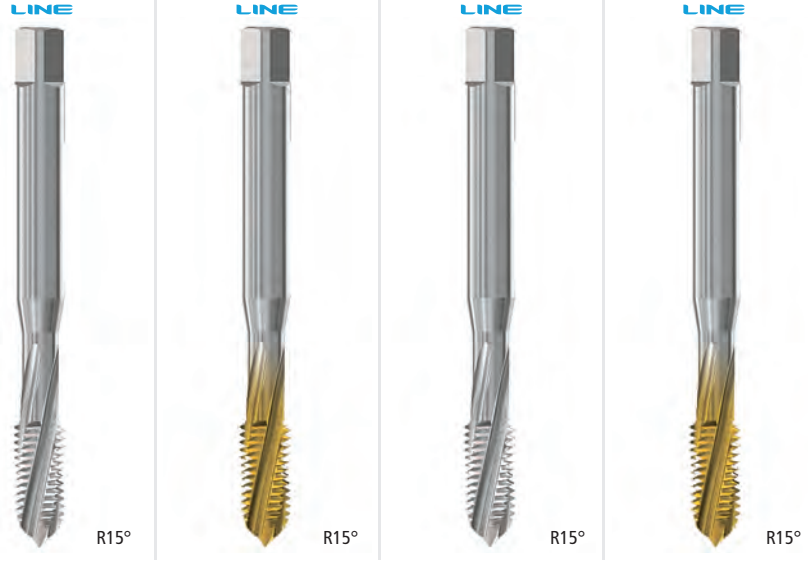
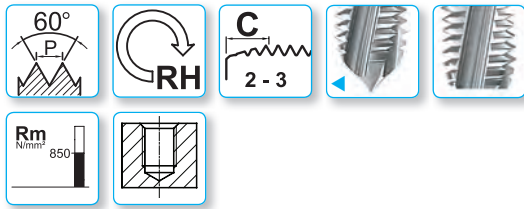
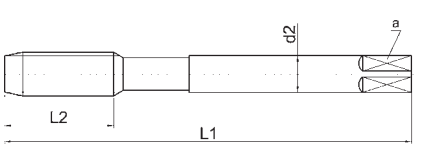

Profond. di filettatura - Thread depth - Profond. de filetage
 Materiale - Material - Matériau
 Tolleranza - Tolerance - Tolérance
 Trattamento superficiale - Surface treatment - Revêtement

1,5xD	1,5xD	1,5xD	1,5xD
HSSE	HSSE	HSSE	HSSE
ISO1/4H	ISO1/4H	ISO3/6G	ISO3/6G
BR	TiN	BR	TiN
1.1 1.2 1.3 1.4	1.1 1.2 1.3 1.4	1.1 1.2 1.3 1.4	1.1 1.2 1.3 1.4
4.1 4.2	3.3 3.4	4.1 4.2	3.3 3.4
5.1 5.2	4.1 4.2 4.3	5.1 5.2	4.1 4.2 4.3
	5.1 5.2		5.1 5.2

Numero gruppi materiali
Material's groups number
Nombre de groupes du matériau

DIN 371	Ød1 M	P mm	L1	L2	d2 h9	a h12	Z	
3	0,5	56	10	3,5	2,7	3	2,5	
4	0,7	63	13	4,5	3,4	3	3,3	
5	0,8	70	13	6	4,9	3	4,2	
6	1	80	16	6	4,9	3	5	
8	1,25	90	18	8	6,2	3	6,8	
10	1,5	100	20	10	8	3	8,5	

CODICE - CODE			
E40M...-4H	E40M...T-4H	E40M...-6G	E40M...T-6G
○	○	●	○
○	○	●	○
○	○	●	○
○	○	●	○
○	○	●	○
○	○	●	○

DIN 376	Ød1 M	P mm	L1	L2	d2 h9	a h12	Z	
12	1,75	110	25	9	7	3	10,3	
14	2	110	28	11	9	3	12	
16	2	110	28	12	9	3	14	
18	2,5	125	33	14	11	4	15,5	
20	2,5	140	33	16	12	4	17,5	
22	2,5	140	33	18	14,5	4	19,5	
24	3	160	39	18	14,5	4	21	
27	3	160	39	20	16	4	24	
30	3,5	180	46	22	18	4	26,5	

CODICE - CODE			
E41M...-4H	E41M...T-4H	E41M...-6G	E41M...T-6G
○	○	○	○
○	○	○	○
○	○	○	○
○	○	○	○
○	○	○	○
○	○	○	○
○	○	○	○
○	○	○	○
○	○	○	○

Confezione / Box / Colis: M3 – M10: 10 pezzi / pcs M12 – M16: 5 pezzi / pcs

€ Pag. listino - Price list - Liste des prix

● Standard ○ Disponibilità da richiedere, prezzo a listino On enquiry, standard price-list / Stock à vérifier

★ Solo a richiesta Only on request / Sur demande

M Filettatura metrica ISO passo grosso DIN 13

ISO Metric coarse thread DIN 13

Metrisches ISO-Regelgewinde DIN13 – Maschinengewindebohrer

Filetage métrique ISO DIN 13 – Tarauds machine

Rosca ISO métrica regular DIN13 – Machos de rosca a máquina



N

USO GENERALE

General purpose - Usage Général

MASCHI A MACCHINA

MACHINE TAPS - TARAUDS MACHINE

DIN 371

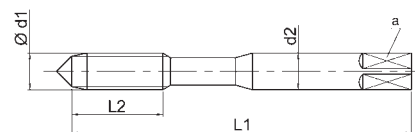

DIN 376

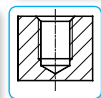
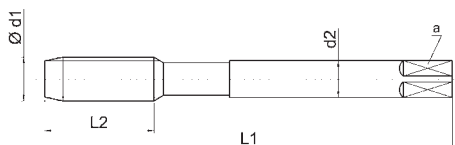

LINE



R15°

LINE



R15°

LINE



R15°

LINE



R15°

Profond. di filettatura - Thread depth - Profond. de filetage

1,5xD

1,5xD

1,5xD

1,5xD

Materiale - Material - Matériau

HSSE

HSSE

HSSE

HSSE

Tolleranza - Tolerance - Tolérance

7G (6H+0,05)

7G (6H+0,05)

6H+0,1

6H+0,1

Trattamento superficiale - Surface treatment - Revêtement

BR

TiN

BR

TiN

Numero gruppi materiali

Material's groups number

Nombre de groupes du matériau

1.1 1.2 1.3 1.4

4.1 4.2

5.1 5.2

1.1 1.2 1.3 1.4

3.3 3.4

4.1 4.2 4.3

5.1 5.2

1.1 1.2 1.3 1.4

4.1 4.2

5.1 5.2

1.1 1.2 1.3 1.4

3.3 3.4

4.1 4.2 4.3

5.1 5.2

DIN 371	Ød1 M	P mm	L1	L2	d2 h9	a h12	Z	
3	0,5	56	10	3,5	2,7	3	2,5	
4	0,7	63	13	4,5	3,4	3	3,3	
5	0,8	70	13	6	4,9	3	4,2	
6	1	80	16	6	4,9	3	5	
8	1,25	90	18	8	6,2	3	6,8	
10	1,5	100	20	10	8	3	8,5	

CODICE - CODE			
E40M...-7G	E40M...T-7G	E40M...+0,1	E40M...T+0,1
○	○	○	○
○	○	○	○
○	○	○	○
○	○	●	○
○	○	●	○
○	○	●	○

DIN 376	Ød1 M	P mm	L1	L2	d2 h9	a h12	Z	
12	1,75	110	25	9	7	3	10,3	
14	2	110	28	11	9	3	12	
16	2	110	28	12	9	3	14	
18	2,5	125	33	14	11	4	15,5	
20	2,5	140	33	16	12	4	17,5	
22	2,5	140	33	18	14,5	4	19,5	
24	3	160	39	18	14,5	4	21	
27	3	160	39	20	16	4	24	
30	3,5	180	46	22	18	4	26,5	

CODICE - CODE			
E41M...-7G	E41M...T-7G	E41M...+0,1	E41M...T+0,1
○	○	○	○
○	○	○	○
○	○	○	○
○	○	○	○
○	○	○	○
○	○	○	○
○	○	○	○
○	○	○	○
○	○	○	○

Confezione / Box / Colis:
M3 – M10: 10 pezzi / pcs
M12 – M16: 5 pezzi / pcs

€ Pag. listino - Price list - Liste des prix

22

23

23

23

● Standard

○ Disponibilità da richiedere, prezzo a listino
On enquiry, standard price-list / Stock à vérifier

★ Solo a richiesta
Only on request / Sur demande

Al-Cu-Fe

ALLUMINIO, RAME, ACCIAIO R ≤ 700 N/mm²

Al, Cu, Steel R≤700 N/mm² - Al, Cu, Acier R≤700 N/mm²

MASCHI A MACCHINA

MACHINE TAPS - TARAUDS MACHINE

DIN 371

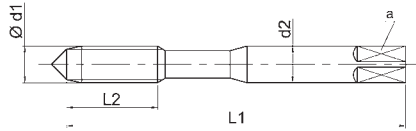

DIN 376

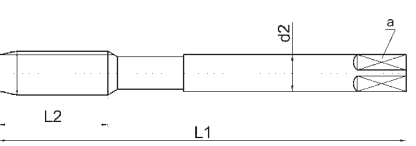

LINE



LINE



LINE



LINE



Profond. di filettatura - Thread depth - Profond. de filetage

Materiale - Material - Matériau

Tolleranza - Tolerance - Tolérance

Trattamento superficiale - Surface treatment - Revêtement

Numero gruppi materiali

Material's groups number

Nombre de groupes du matériau

1,5xD	1,5xD	1,5xD	1,5xD
HSSE	HSSE	HSSE	HSSE
ISO2/6H	ISO2/6H	ISO2/6H	ISO2/6H
BR	V	ZrN	CrN
1.1 4.1 4.2	1.1 4.1 4.2	1.1 1.2 1.3 1.4	1.1 1.2 1.3 1.4
5.1 5.2	5.1 5.2	3.3 3.4	5.1 5.2
6.1 7.1	6.1 7.1	4.2 4.3	
8.1	8.1	5.2	

DIN 371	Ød1 M	P mm	L ₁	L ₂	d ₂ h9	a h12	Z	
3	0,5	56	10	3,5	2,7	3	2,5	
4	0,7	63	13	4,5	3,4	3	3,3	
5	0,8	70	13	6	4,9	3	4,2	
6	1	80	16	6	4,9	3	5	
8	1,25	90	18	8	6,2	3	6,8	
10	1,5	100	20	10	8	3	8,5	

CODICE - CODE			
E40M...AZ	E40M...AZ-V	*E40M...TZ	E40M...NC
<input type="radio"/>	<input type="radio"/>	<input type="radio"/>	<input type="radio"/>
<input type="radio"/>	<input type="radio"/>	<input type="radio"/>	<input type="radio"/>
<input type="radio"/>	<input type="radio"/>	<input type="radio"/>	<input type="radio"/>
<input type="radio"/>	<input type="radio"/>	<input type="radio"/>	<input type="radio"/>
<input type="radio"/>	<input type="radio"/>	<input type="radio"/>	<input type="radio"/>

DIN 376	Ød1 M	P mm	L ₁	L ₂	d ₂ h9	a h12	Z	
12	1,75	110	25	9	7	3	10,3	
14	2	110	28	11	9	3	12	
16	2	110	28	12	9	3	14	

CODICE - CODE			
E41M...AZ	E41M...AZ-V	*E41M...TZ	E41M...NC
<input type="radio"/>	<input type="radio"/>	<input type="radio"/>	<input type="radio"/>
<input type="radio"/>	<input type="radio"/>	<input type="radio"/>	<input type="radio"/>
<input type="radio"/>	<input type="radio"/>	<input type="radio"/>	<input type="radio"/>

* In alternativa si consiglia:
Alternatively we recommend:
Par ailleurs, nous vous recommandons:
E40M...XP pag. 36
E41M...XP pag. 37

Confezione / Box / Colis: M3 – M10: 10 pezzi / pcs M12 – M16: 5 pezzi / pcs	€ Pag. listino - Price list - Liste des prix	23	23	23	24
● Standard	○ Disponibilità da richiedere, prezzo a listino On enquiry, standard price-list / Stock à vérifier	○ Solo a richiesta Only on request / Sur demande			

M Filettatura metrica ISO passo grosso DIN 13

ISO Metric coarse thread DIN 13

Metrisches ISO-Regelgewinde DIN13 – Maschinengewindebohrer

Filetage métrique ISO DIN 13 – Tarauds machine

Rosca ISO métrica regular DIN13 – Machos de rosca a máquina

N

USO GENERALE

General purpose - Usage Général

MASCHI A MACCHINA

MACHINE TAPS - TARAUDS MACHINE

DIN 371

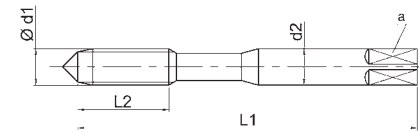

DIN 376

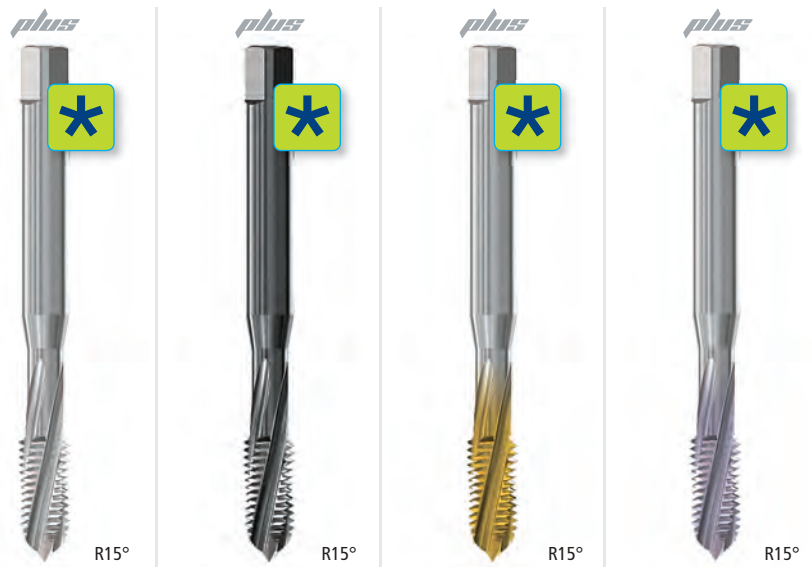
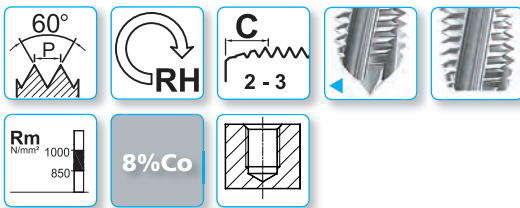
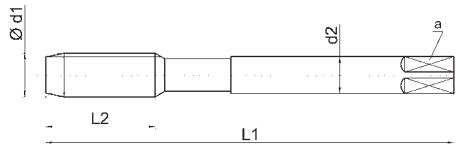

Profond. di filettatura - Thread depth - Profond. de filetage

Materiale - Material - Matériau

Tolleranza - Tolerance - Tolérance

Trattamento superficiale - Surface treatment - Revêtement

Numero gruppi materiali

Material's groups number

Nombre de groupes du matériau

1,5xD

HSSP

ISO2/6H

BR

1.1 1.2 1.3 1.4

4.1 4.2

5.1 5.2

1,5xD

HSSP

ISO2/6H

V

1.1 1.2 1.3 1.4

4.1 4.2

5.1 5.2

6.1 7.1

1,5xD

HSSP

ISO2/6H

TiN

1.1 1.2 1.3 1.4 1.5

3.3 3.4 4.1 4.2 4.3

5.1 5.2

1,5xD

HSSP

ISO2/6H

TiCN

1.1 1.2 1.3 1.4 1.5

3.3 3.4 4.2 4.3

5.2

DIN 371	Ød1 M	P mm	L1	L2	d2 h9	a h12	Z	
3	0,5	56	10	3,5	2,7	3	2,5	
4	0,7	63	13	4,5	3,4	3	3,3	
5	0,8	70	13	6	4,9	3	4,2	
6	1	80	16	6	4,9	3	5	
8	1,25	90	18	8	6,2	3	6,8	
10	1,5	100	20	10	8	3	8,5	

DIN 376	Ød1 M	P mm	L1	L2	d2 h9	a h12	Z	
12	1,75	110	25	9	7	3	10,3	
14	2	110	28	11	9	3	12	
16	2	110	28	12	9	3	14	
18	2,5	125	33	14	11	4	15,5	
20	2,5	140	33	16	12	4	17,5	
22	2,5	140	33	18	14,5	4	19,5	
24	3	160	39	18	14,5	4	21	
27	3	160	39	20	16	4	24	
30	3,5	180	46	22	18	4	26,5	

CODICE - CODE

P40M...

P40M... V

P40M...T

P40M...CT

○

○

○

○

○

○

○

○

○

○

○

○

○

○

○

○

○

○

○

○

CODICE - CODE

P41M...

P41M... V

P41M...T

P41M...CT

○

○

○

○

○

○

○

○

○

○

○

○

○

○

○

○

○

○

○

○

○

○

○

○

○

○

○

○

○

○

○

○



Ad esaurimento scorte

Stock clearance - Stock épuisé

Confezione / Box / Colis:
M3 - M10: 10 pezzi / pcs
M12 - M16: 5 pezzi / pcs

€ Pag. listino - Price list - Liste des prix

24

24

24

24

● Standard

○ Disponibilità da richiedere, prezzo a listino
On enquiry, standard price-list / Stock à vérifier

★ Solo a richiesta
Only on request / Sur demande

HR

ALTA RESISTENZA

High Resistance - Haute Résistance

MASCHI A MACCHINA

MACHINE TAPS - TARAUDS MACHINE

DIN 371

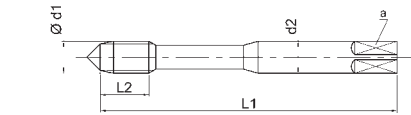

DIN 371

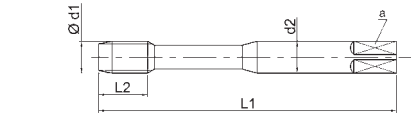

DIN 376

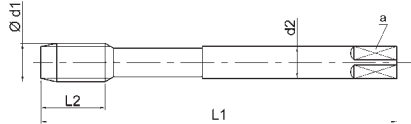

TOP



R15°

TOP



R15°

Profond. di filettatura - Thread depth - Profond. de filetage

1,5xD

2,5xD

Materiale - Material - Matériau

PM3

PM3

Tolleranza - Tolerance - Tolérance

6HX

6HX

Trattamento superficiale - Surface treatment - Revêtement

TXC

TXC

Numero gruppi materiali

Material's groups number

Nombre de groupes du matériau

1.5 1.6

1.5 1.6

3.3 3.4

3.3 3.4

4.4 4.5 4.6

4.4 4.5 4.6

5.3

5.3

DIN 371	Ød1 M	P mm	L1	L2 10xP	d2 h9	a h12	Z	
3	0,5	56	5	3,5	2,7	3	2,5	
4	0,7	63	7	4,5	3,4	3	3,3	
5	0,8	70	8	6	4,9	3	4,2	
6	1	80	10	6	4,9	3	5	
8	1,25	90	13	8	6,2	3	6,8	
10	1,5	100	15	10	8	3	8,5	

CODICE - CODE	
K40M...TXC	K40M...FOR-TXC
•	-
•	-
•	-
•	○
•	○
•	○

DIN 376	Ød1 M	P mm	L1	L2 10xP	d2 h9	a h12	Z	
12	1,75	110	18	9	7	4	10,3	
14	2	110	20	11	9	4	12	
16	2	110	20	12	9	4	14	

CODICE - CODE	
K41M...TXC	K41M...FOR-TXC
•	○
○	○
○	○

Confezione / Box / Colis:
M3 – M10: 10 pezzi / pcs
M12 – M16: 5 pezzi / pcs

€ Pag. listino - Price list - Liste des prix

25

25

• Standard

○ Disponibilità da richiedere, prezzo a listino
On enquiry, standard price-list / Stock à vérifier

★ Solo a richiesta
Only on request / Sur demande

Filettatura metrica ISO passo grosso DIN 13**ISO Metric coarse thread DIN 13**

Metrisches ISO-Regelgewinde DIN13 – Maschinengewindebohrer

Filetage métrique ISO DIN 13 – Tarauds machine

Rosca ISO métrica regular DIN13 – Machos de rosca a máquina

Ti

TITANIO

Titanium - Titane

MASCHI A MACCHINA

MACHINE TAPS - TARAUDS MACHINE

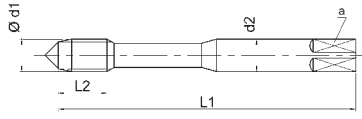
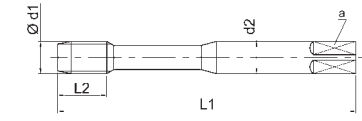
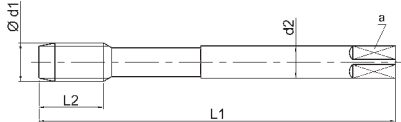
DIN
371DIN
371DIN
376

TOP



R15°

TOP



R15°

TOP



R15°

TOP



R25°

Profond. di filettatura - Thread depth - Profond. de filetage

Materiale - Material - Matériau

Tolleranza - Tolerance - Tolérance

Trattamento superficiale - Surface treatment - Revêtement

Numero gruppi materiali

Material's groups number

Nombre de groupes du matériau

1,5xD

1,5xD

1,5xD

2,5xD

PM3

PM3

PM3

PM3

6HX

6HX

4H

6HX

V

TiCN

V

V

6.1

1.6 2.4

6.1

6.1 6.2

3.3 3.4

4.4 5.3 5.4 6.2 6.3

7.2 9.2

DIN	Ød1	P	L1	L2	d2	a	Z	
371	M	mm		10xP	h9	h12		
◀	3	0,5	56	5	3,5	2,7	3	*2,5
◀	4	0,7	63	7	4,5	3,4	3	*3,3
◀	5	0,8	70	8	6	4,9	3	*4,2
◀	6	1	80	10	6	4,9	3	*5
	8	1,25	90	13	8	6,2	3	*6,8
	10	1,5	100	15	10	8	3	*8,5
◀	3	0,5	56	10	3,5	2,7	3	*2,5
◀	4	0,7	63	13	4,5	3,4	3	*3,3
◀	5	0,8	70	13	6	4,9	3	*4,2
◀	6	1	80	16	6	4,9	3	*5
	8	1,25	90	18	8	6,2	3	*6,8
	10	1,5	100	20	10	8	3	*8,5

DIN	Ød1	P	L1	L2	d2	a	Z	
376	M	mm		10xP	h9	h12		
	12	1,75	110	18	9	7	4	*10,3
	16	2	110	20	12	9	4	*14
	12	1,75	110	25	9	7	4	*10,3
	16	2	110	28	12	9	4	*14

CODICE - CODE

K42M...V

K42M...CT

*K42MJ...V

○

○

○

○

○

○

○

○

○

○

○

○

○

○

○

K28M...AZ-V

*

*

*

*

*

*

CODICE - CODE

K43M...V

K43M...CT

*K43MJ...V

○

○

○

○

○

○

K29M...AZ-V

*

*



Solo a richiesta

Only on request / Sur demande

* Per MJ vedi tabella di foratura pag. 252

* Drills' diameters for MJ: table page 252

* Pour MJ voir le tableau de perçage page 252

* Rivestimento TiCN a richiesta, prezzo a listino

* TiCN coating on request, standard price-list

* Revêtement TiCN sur demande, liste de prix

Confezione / Box / Colis:
M3 – M10: 10 pezzi / pcs
M12 – M16: 5 pezzi / pcs

€ Pag. listino - Price list - Liste des prix

25

25

25

26

● Standard

○ Disponibilità da richiedere, prezzo a listino
On enquiry, standard price-list / Stock à vérifier

Ni

NICHEL

Nickel - Nickel

MASCHI A MACCHINA

MACHINE TAPS - TARAUDS MACHINE

UFS norm

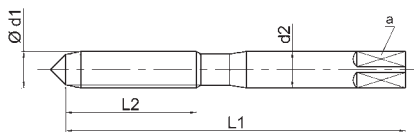

UFS norm

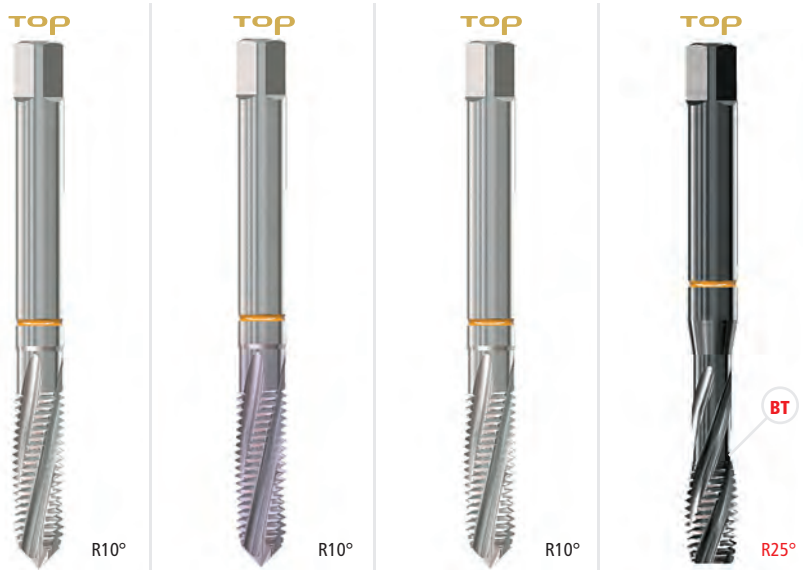
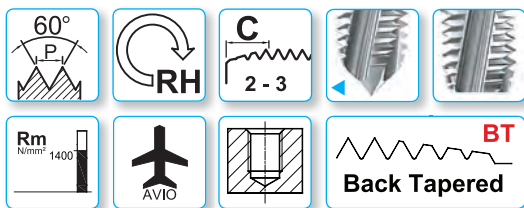
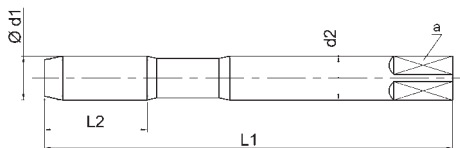

Profond. di filettatura - Thread depth - Profond. de filetage
 Materiale - Material - Matériau
 Tolleranza - Tolerance - Tolérance
 Trattamento superficiale - Surface treatment - Revêtement
 Numero gruppi materiali
 Material's groups number
 Nombre de groupes du matériau

1,5xD	1,5xD	1,5xD	2,5xD
PM3	PM3	PM3	PM3
6HX	6HX	4HX	6HX
BR	TiCN	BR	V
7.3 9.3	1.6 5.4	7.3 9.3	7.1 7.2
	7.2 9.1		

UFS norm	Ød1 M	P mm	L1	L2	d2 h9	a h12	Z	
3	0,5	56	10	3,5	2,7	3	*2,5	
4	0,7	63	13	4,5	3,4	3	*3,3	
5	0,8	70	15	6	4,9	3	*4,2	
6	1	80	18	6	4,9	3	*5	
8	1,25	90	25	8	6,2	3	*6,8	
10	1,5	100	30	10	8	3	*8,5	
3	0,5	56	10	3,5	2,7	3	*2,5	
4	0,7	63	13	4,5	3,4	3	*3,3	
5	0,8	70	13	6	4,9	3	*4,2	
6	1	80	16	6	4,9	3	*5	
8	1,25	90	18	8	6,2	3	*6,8	
10	1,5	100	20	10	8	3	*8,5	

CODICE - CODE			
K42M...NI	K42M...NI-CT	K42M...NI-4HX	
○	○	○	
○	○	○	
○	○	○	
○	○	○	
○	○	○	
○	○	○	
-	-	-	K28M...V
-	-	-	*
-	-	-	*
-	-	-	*
-	-	-	*
-	-	-	*
-	-	-	*

UFS norm	Ød1 M	P mm	L1	L2	d2 h9	a h12	Z	
12	1,75	110	30	12	9	4	*10,3	
12	1,75	110	25	9	7	4	*10,3	
14	2	110	28	11	9	4	*12	
16	2	110	28	12	9	4	*14	

CODICE - CODE			
K42M...NI	K42M...NI-CT	K42M... NI-4HX	
○	○	○	
-	-	-	K29M...V
-	-	-	*
-	-	-	*
-	-	-	*

★ Solo a richiesta
 Only on request / Sur demande

* Per MJ vedi tabella di foratura pag. 252
 * Drills' diameters for MJ: table page 252
 * Pour MJ voir le tableau de perçage page 252

Confezione / Box / Colis: M3 – M10: 10 pezzi / pcs M12 – M16: 5 pezzi / pcs	€ Pag. listino - Price list - Liste des prix	26	26	26	26
	● Standard	○ Disponibilità da richiedere, prezzo a listino On enquiry, standard price-list / Stock à vérifier			

M Filettatura metrica ISO passo grosso DIN 13

ISO Metric coarse thread DIN 13
 Metrisches ISO-Regelgewinde DIN13 – Maschinengewindebohrer
 Filetage métrique ISO DIN 13 – Tarauds machine
 Rosca ISO métrica regular DIN13 – Machos de rosca a máquina

MASCHI A MACCHINA

MACHINE TAPS - TARAUDS MACHINE

N

USO GENERALE

General purpose - Usage Général

DIN 371

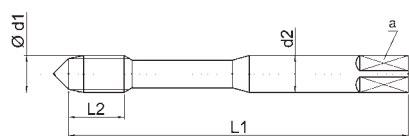

DIN 371

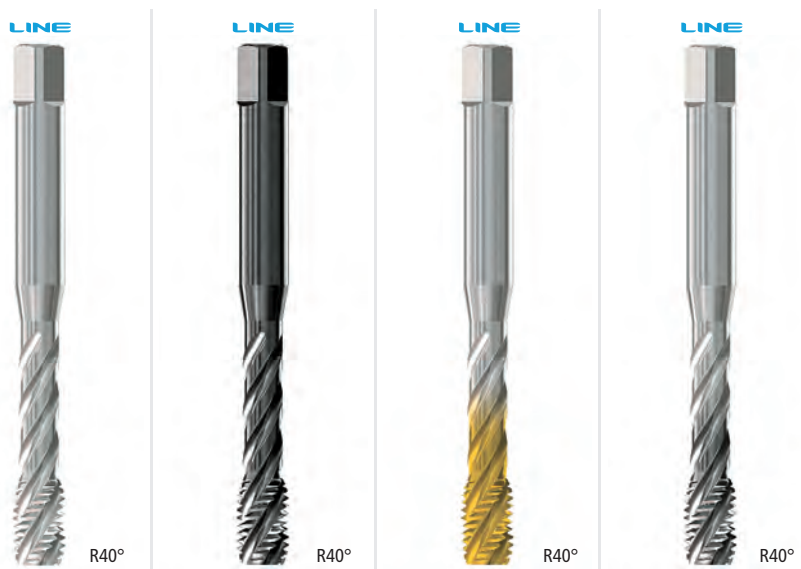
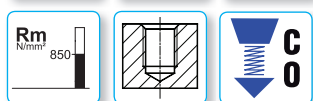
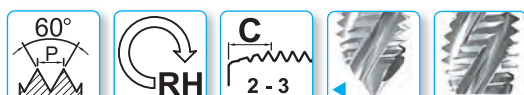
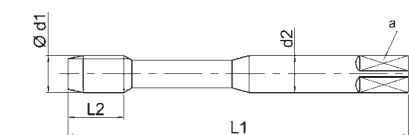

Profond. di filettatura - Thread depth - Profond. de filetage

Materiale - Material - Matériau

Tolleranza - Tolerance - Tolérance

Trattamento superficiale - Surface treatment - Revêtement

Numero gruppi materiali

Material's groups number

Nombre de groupes du matériau

2,5xD

HSSE

ISO2/6H

BR

1.1 1.2 1.3 1.4

4.1 4.2

5.1 5.2

2,5xD

HSSE

ISO2/6H

V

1.1 1.2 1.3 1.4

4.1 4.2

5.1 5.2

2,5xD

HSSE

ISO2/6H

TiN

1.1 1.2 1.3 1.4

3.3 3.4

4.1 4.2 4.3

5.1 5.2

2,5xD

HSSE

ISO2/6H

TXC

1.1 1.2 1.3 1.4

2.1 2.2 3.3 3.4

4.2 4.3

5.2

DIN 371	$\varnothing d1$ M	P mm	L ₁	L ₂	d ₂ h ₉	a h ₁₂	Z	
◀	1	0,25	40	5	2,5	2,1	-	0,75
◀	1,2	0,25	40	5	2,5	2,1	-	0,95
◀	1,4	0,3	40	7	2,5	2,1	-	1,1
◀	1,6	0,35	40	8	2,5	2,1	-	1,25
◀	1,7	0,35	40	8	2,5	2,1	-	1,35
◀	1,8	0,35	40	8	2,5	2,1	-	1,45
◀	2	0,4	45	7	2,8	2,1	3	1,6
◀	2,2	0,45	45	7	2,8	2,1	3	1,75
◀	2,3	0,4	45	7	2,8	2,1	3	1,9
◀	2,5	0,45	50	9	2,8	2,1	3	2,05
◀	2,6	0,45	50	9	2,8	2,1	3	2,10
◀	3	0,5	56	5	3,5	2,7	3	2,5
◀	3,5	0,6	56	7	4	3	3	2,9
◀	4	0,7	63	7	4,5	3,4	3	3,3
◀	4,5	0,75	70	8	6	4,9	3	3,70
◀	5	0,8	70	8	6	4,9	3	4,2
◀	6	1	80	10	6	4,9	3	5
	7	1	80	10	7	5,5	3	6
	8	1,25	90	13	8	6,2	3	6,8
	9	1,25	90	18	9	7	3	7,80
	10	1,5	100	15	10	8	3	8,5
◀	8	1,25	90	18	8	6,2	3	6,8
◀	10	1,5	100	20	10	8	3	8,5

E60M...	CODICE - CODE		
	E60M...V	E60M...T	E60M...TXC
*	-	-	-
*	-	-	-
*	-	-	-
*	-	-	-
*	-	-	-
*	-	-	-
●	○	○	-
○	○	○	-
○	○	○	-
●	○	○	-
○	○	○	-
○	○	○	-
●	●	●	●
○	○	○	○
○	○	○	○
●	●	●	●
○	○	○	○
○	○	○	○
○	○	○	○
○	○	○	○
○	○	○	○
○	○	○	○
○	○	○	○
○	○	○	○

Segue diametri
 Diameters, to be continued
 Diamètres à suivre

Pag. 47

Confezione / Box / Colis:
 M1 – M10: 10 pezzi / pcs
 M12 – M16: 5 pezzi / pcs

€ Pag. listino - Price list - Liste des prix
 • Standard

26
 • Disponibilità da richiedere, prezzo a listino
 On enquiry, standard price-list / Stock à vérifier

27
 • Solo a richiesta
 Only on request / Sur demande

N
USO GENERALE

General purpose - Usage Général

MASCHI A MACCHINA

MACHINE TAPS - TARAUDS MACHINE

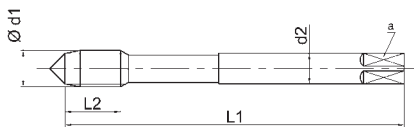
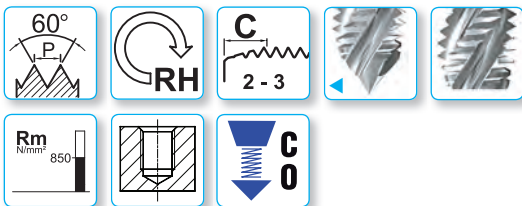
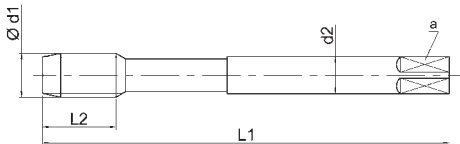
DIN 376

DIN 376

R40°



R40°



R40°



R40°

Profond. di filettatura - Thread depth - Profond. de filetage

Materiale - Material - Matériau

Tolleranza - Tolerance - Tolérance

Trattamento superficiale - Surface treatment - Revêtement

Numero gruppi materiali

Material's groups number

Nombre de groupes du matériau

2,5xD
HSSE
ISO2/6H
BR

1.1 1.2 1.3 1.4

4.1 4.2

5.1 5.2

2,5xD
HSSE
ISO2/6H
V

1.1 1.2 1.3 1.4

4.1 4.2

5.1 5.2

2,5xD
HSSE
ISO2/6H
TiN

1.1 1.2 1.3 1.4

3.3 3.4

4.1 4.2 4.3

2,5xD
HSSE
ISO2/6H
TXC

1.1 1.2 1.3 1.4

2.1 2.2 3.3 3.4

4.2 4.3

5.2

DIN 376	Ød1 M	P mm	L ₁	L ₂	d ₂ h9	a h12	Z	Z	
◀	4	0,7	63	7	2,8	2,1	3	3,3	
◀	5	0,8	70	8	3,5	2,7	3	4,2	
◀	6	1	80	10	4,5	3,4	3	5	
	8	1,25	90	13	6	4,9	3	6,8	
	10	1,5	100	15	7	5,5	3	8,5	
	11	1,5	100	15	8	6,2	3	9,5	
	12	1,75	110	18	9	7	3	10,3	
	14	2	110	20	11	9	3	12	
	16	2	110	20	12	9	4	14	
	18	2,5	125	25	14	11	4	15,5	
	20	2,5	140	25	16	12	4	17,5	
	22	2,5	140	25	18	14,5	4	19,5	
	24	3	160	30	18	14,5	4	21	
	27	3	160	30	20	16	4	24	
	30	3,5	180	35	22	18	4	26,5	
	33	3,5	180	35	25	20	4	29,5	
	36	4	200	40	28	22	4	32	
	39	4	200	40	32	24	4	35	
	42	4,5	200	40	32	24	5	37,5	
■	45	4,5	220	50	36	29	5	40,5	
■	48	5	250	50	36	29	5	43	
■	52	5	250	50	40	32	5	47	

■ = Acciaio HSS / HSS Steel / Acier HSS

CODICE - CODE			
E61M...	E61M...V	E61M...T	E61M...TXC
*	*	*	*
○	○	○	○
○	○	○	○
●	●	●	●
●	●	●	●
○	○	○	○
●	●	●	●
●	●	●	●
●	○	○	○
●	○	○	○
●	○	○	○
●	○	○	○
●	○	○	○
○	○	○	○
○	○	○	○
○	○	○	○
○	○	○	○
○	○	○	○
○	○	○	○
○	○	○	○
○	○	○	○
○	○	○	○
○	○	○	○
○	○	○	○
○	○	○	○

 Confezione / Box / Colis:
 M3 – M10: 10 pezzi / pcs
 M12 – M16: 5 pezzi / pcs

€ Pag. listino - Price list - Liste des prix

27
27
28
28

● Standard

 ○ Disponibilità da richiedere, prezzo a listino
 On enquiry, standard price-list / Stock à vérifier

 ★ Solo a richiesta
 Only on request / Sur demande

Filettatura metrica ISO passo grosso DIN 13**ISO Metric coarse thread DIN 13**

Metrisches ISO-Regelgewinde DIN13 – Maschinengewindebohrer

Filetage métrique ISO DIN 13 – Tarauds machine

Rosca ISO métrica regular DIN13 – Machos de rosca a máquina

N

USO GENERALE

General purpose - Usage Général

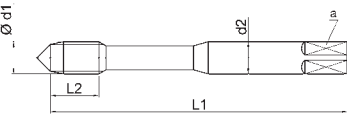
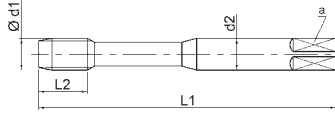
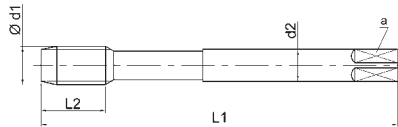
MASCHI A MACCHINA**MACHINE TAPS - TARAUDS MACHINE**DIN
371DIN
371DIN
376

Profond. di filettatura - Thread depth - Profond. de filetage

Materiale - Material - Matériau

Tolleranza - Tolerance - Tolérance

Trattamento superficiale - Surface treatment - Revêtement

Numero gruppi materiali

Material's groups number

Nombre de groupes du matériau

LINE



R40°

3xD

HSSE

ISO2/6H

BR

1.1 1.2 1.3 1.4

4.1 4.2

5.1 5.2

LINE



R40°

3xD

HSSE

ISO2/6H

TiN

1.1 1.2 1.3 1.4

3.3 3.4

4.1 4.2 4.3

5.1 5.2

LINE



R40°

3xD

HSSE

ISO2/6H

TXC

1.1 1.2 1.3 1.4

2.1 2.2 3.3 3.4

4.2 4.3

5.2

DIN 371	Ød1 M	P mm	L1	L2	d2 h9	a h12	Z	
6	1	80	10	6	4,9	3	5	
8	1,25	90	13	8	6,2	3	6,8	
10	1,5	100	15	10	8	3	8,5	

CODICE - CODE	E60M...FOR		
	E60M...FOR	E60M...FOR-T	E60M...FOR-TXC
	<input type="radio"/>	<input type="radio"/>	<input type="radio"/>
	<input type="radio"/>	<input type="radio"/>	<input type="radio"/>
	<input type="radio"/>	<input type="radio"/>	<input type="radio"/>

DIN 376	Ød1 M	P mm	L1	L2	d2 h9	a h12	Z	
12	1,75	110	18	9	7	3	10,3	
14	2	110	20	11	9	3	12	
16	2	110	20	12	9	4	14	
18	2,5	125	25	14	11	4	15,5	
20	2,5	140	25	16	12	4	17,5	
22	2,5	140	25	18	14,5	4	19,5	
24	3	160	30	18	14,5	4	21	

CODICE - CODE	E61M...FOR		
	E61M...FOR	E61M...FOR-T	E61M...FOR-TXC
	<input type="radio"/>	<input type="radio"/>	<input type="radio"/>
	<input type="radio"/>	<input type="radio"/>	<input type="radio"/>
	<input type="radio"/>	<input type="radio"/>	<input type="radio"/>
	<input type="radio"/>	<input type="radio"/>	<input type="radio"/>
	<input type="radio"/>	<input type="radio"/>	<input type="radio"/>
	<input type="radio"/>	<input type="radio"/>	<input type="radio"/>
	<input type="radio"/>	<input type="radio"/>	<input type="radio"/>

Confezione / Box / Colis:
M3 – M10: 10 pezzi / pcs
M12 – M16: 5 pezzi / pcs

€ Pag. listino - Price list - Liste des prix

28

28

28

● Standard

○ Disponibilità da richiedere, prezzo a listino
On enquiry, standard price-list / Stock à vérifier

★ Solo a richiesta
Only on request / Sur demande

N **USO GENERALE**
General purpose - Usage Général

DIN 371

DIN 371

DIN 376

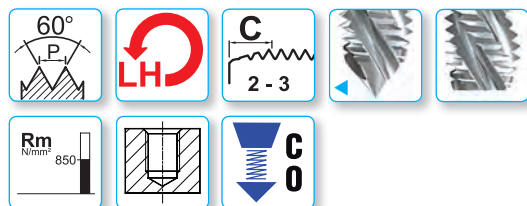
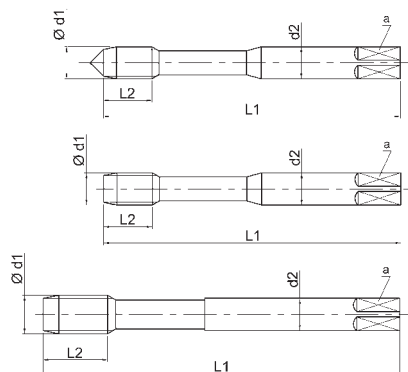

Profond. di filettatura - Thread depth - Profond. de filetage
Materiale - Material - Matériau
Tolleranza - Tolerance - Tolérance

Treatmento superficiale - Surface treatment - Revêtement

Numero gruppi materiali
Material's groups number
Nombre de groupes du matériau

DIN 371	Ød1 M	P mm	L ₁	L ₂	d ₂ h9	a h12	Z	
◀	3	0,5	56	5	3,5	2,7	3	2,5
◀	4	0,7	63	7	4,5	3,4	3	3,3
◀	5	0,8	70	8	6	4,9	3	4,2
◀	6	1	80	10	6	4,9	3	5
	8	1,25	90	13	8	6,2	3	6,8
	10	1,5	100	15	10	8	3	8,5

DIN 376	Ød1 M	P mm	L ₁	L ₂	d ₂ h9	a h12	Z	
	12	1,75	110	18	9	7	3	10,3
	14	2	110	20	11	9	3	12
	16	2	110	20	12	9	4	14
	18	2,5	125	25	14	11	4	15,5
	20	2,5	140	25	16	12	4	17,5
	22	2,5	140	25	18	14,5	4	19,5
	24	3	160	30	18	14,5	4	21

MASCHI A MACCHINA, FILETTATURA SINISTRA
LEFT THREAD MACHINE TAPS - TARAUDS MACHINE GAUCHE

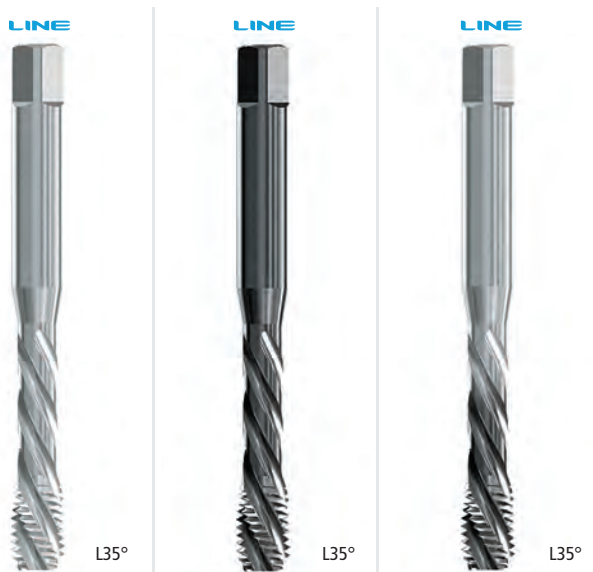

2,5xD	2,5xD	2,5xD
HSSE	HSSE	HSSE
ISO2/6H	ISO2/6H	ISO2/6H
BR	V	XP
1.1 1.2 1.3 1.4	1.1 1.2 1.3 1.4	1.1 1.2 1.3 1.4
4.1 4.2	4.1 4.2	2.1 2.2 3.3 3.4
5.1 5.2	5.1 5.2	4.2 4.3
		5.2

CODICE - CODE		
E60M...LH	E60M...LH-V	E60M...LH-XP
○	○	○
○	○	○
○	○	○
○	○	○
○	○	○
○	○	○

CODICE - CODE		
E61M...LH	E61M...LH-V	E61M...LH-XP
○	○	○
○	○	○
○	○	○
○	○	○
○	○	○
○	○	○
○	○	○

M Filettatura metrica ISO passo grosso DIN 13

ISO Metric coarse thread DIN 13

Metrisches ISO-Regelgewinde DIN13 – Maschinengewindebohrer
Filetage métrique ISO DIN 13 – Tarauds machine
Rosca ISO métrica regular DIN13 – Machos de rosca a máquina

N

USO GENERALE
General purpose - Usage Général

MASCHI A MACCHINA

MACHINE TAPS - TARAUDS MACHINE

DIN 371

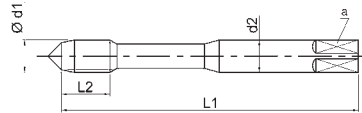

DIN 371

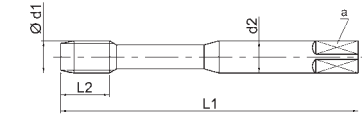

DIN 376

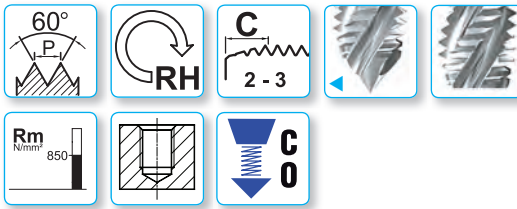
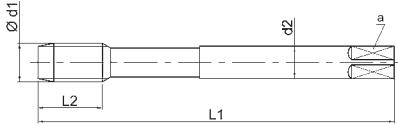

LINE



R40°

LINE



R40°

LINE



R40°

LINE



R40°

Profond. di filettatura - Thread depth - Profond. de filetage

2,5xD

2,5xD

2,5xD

2,5xD

Materiale - Material - Matériau

HSSE

HSSE

HSSE

HSSE

Tolleranza - Tolerance - Tolérance

ISO1/4H

ISO1/4H

ISO3/6G

ISO3/6G

Trattamento superficiale - Surface treatment - Revêtement

BR

XP

BR

XP

Numero gruppi materiali

Material's groups number

Nombre de groupes du matériau

1.1 1.2 1.3 1.4

1.1 1.2 1.3 1.4

1.1 1.2 1.3 1.4

1.1 1.2 1.3 1.4

4.1 4.2

2.1 2.2 3.3 3.4

4.1 4.2

2.1 2.2 3.3 3.4

5.1 5.2

4.2 4.3

5.1 5.2

4.2 4.3

5.2

5.2

DIN 371	Ød1 M	P mm	L1	L2	d2 h9	a h12	Z	
◀	3	0,5	56	5	3,5	2,7	3	2,5
◀	4	0,7	63	7	4,5	3,4	3	3,3
◀	5	0,8	70	8	6	4,9	3	4,2
◀	6	1	80	10	6	4,9	3	5
	8	1,25	90	13	8	6,2	3	6,8
	10	1,5	100	15	10	8	3	8,5

CODICE - CODE			
E60M...-4H	E60M...XP-4H	E60M...-6G	E60M...XP-6G
○	○	●	○
○	○	●	○
○	○	●	○
○	○	●	○
○	○	●	○
○	○	●	○

DIN 376	Ød1 M	P mm	L1	L2	d2 h9	a h12	Z	
	12	1,75	110	18	9	7	3	10,3
	14	2	110	20	11	9	3	12
	16	2	110	20	12	9	4	14
	18	2,5	125	25	14	11	4	15,5
	20	2,5	140	25	16	12	4	17,5
	22	2,5	140	25	18	14,5	4	19,5
	24	3	160	30	18	14,5	4	21

CODICE - CODE			
E61M...-4H	E61M... XP-4H	E61M...-6G	E61M... XP-6G
○	○	○	○
○	○	○	○
○	○	○	○
○	○	○	○
○	○	○	○
○	○	○	○

Confezione / Box / Colis:
M3 – M10: 10 pezzi / pcs
M12 – M16: 5 pezzi / pcs

€ Pag. listino - Price list - Liste des prix

29

29

29

30

● Standard

○ Disponibilità da richiedere, prezzo a listino
On enquiry, standard price-list / Stock à vérifier★ Solo a richiesta
Only on request / Sur demande

N **USO GENERALE**
General purpose - Usage Général

MASCHI A MACCHINA
MACHINE TAPS - TARAUDS MACHINE

DIN 371

DIN 371

DIN 376

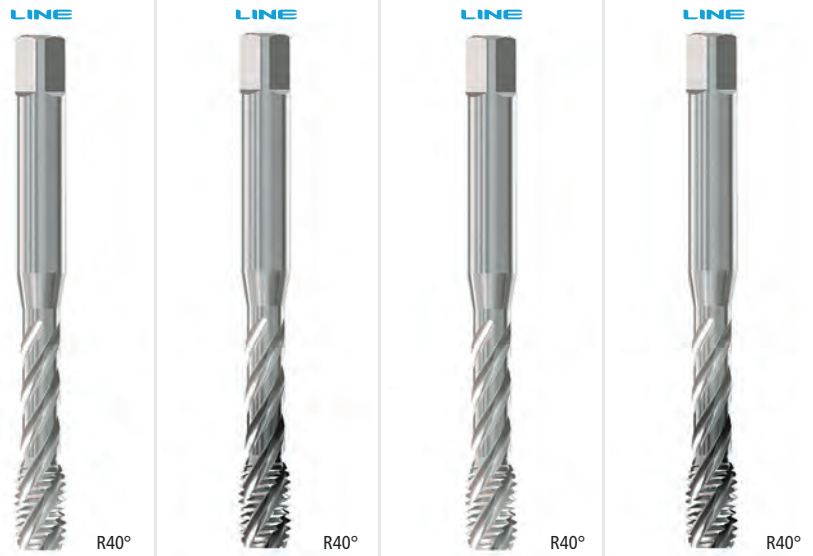
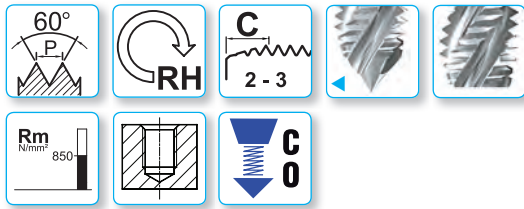
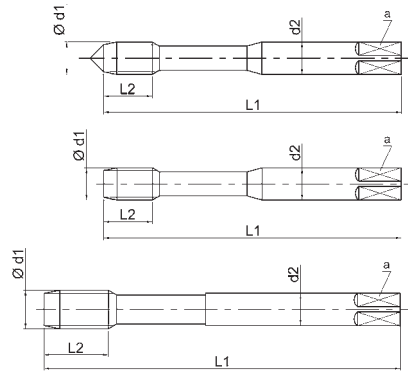

Profond. di filettatura - Thread depth - Profond. de filetage

Materiale - Material - Matériau

Tolleranza - Tolerance - Tolérance

Trattamento superficiale - Surface treatment - Revêtement

Numero gruppi materiali
Material's groups number
Nombre de groupes du matériau

2,5xD	2,5xD	2,5xD	2,5xD
HSSE	HSSE	HSSE	HSSE
7G(6H+0,05)	7G(6H+0,05)	6H+0,1	6H+0,1
BR	XP	BR	XP
1.1 1.2 1.3 1.4	1.1 1.2 1.3 1.4	1.1 1.2 1.3 1.4	1.1 1.2 1.3 1.4
4.1 4.2	2.1 2.2 3.3 3.4	4.1 4.2	2.1 2.2 3.3 3.4
5.1 5.2	4.2 4.3	5.1 5.2	4.2 4.3
	5.2		5.2

DIN 371	Ød1 M	P mm	L1	L2	d2 h9	a h12	Z	
3	0,5	56	5	3,5	2,7	3	2,5	
4	0,7	63	7	4,5	3,4	3	3,3	
5	0,8	70	8	6	4,9	3	4,2	
6	1	80	10	6	4,9	3	5	
8	1,25	90	13	8	6,2	3	6,8	
10	1,5	100	15	10	8	3	8,5	

CODICE - CODE			
E60M...-7G	E60M...XP-7G	E60M...+0,1	E60M...XP+0,1
○	○	○	○
○	○	○	○
○	○	○	○
○	○	●	○
○	○	●	○
○	○	●	○

DIN 376	Ød1 M	P mm	L1	L2	d2 h9	a h12	Z	
12	1,75	110	18	9	7	3	10,3	
14	2	110	20	11	9	3	12	
16	2	110	20	12	9	4	14	
18	2,5	125	25	14	11	4	15,5	
20	2,5	140	25	16	12	4	17,5	
22	2,5	140	25	18	14,5	4	19,5	
24	3	160	30	18	14,5	4	21	

CODICE - CODE			
E61M...-7G	E61M... XP-7G	E61M...+0,1	E61M... XP+0,1
○	○	●	○
○	○	○	○
○	○	○	○
○	○	●	○
○	○	○	○
○	○	○	○
○	○	○	○

Confezione / Box / Colis: M3 – M10: 10 pezzi / pcs M12 – M16: 5 pezzi / pcs	€ Pag. listino - Price list - Liste des prix	30	30	30	30
	● Standard	○ Disponibilità da richiedere, prezzo a listino On enquiry, standard price-list / Stock à vérifier		★ Solo a richiesta Only on request / Sur demande	

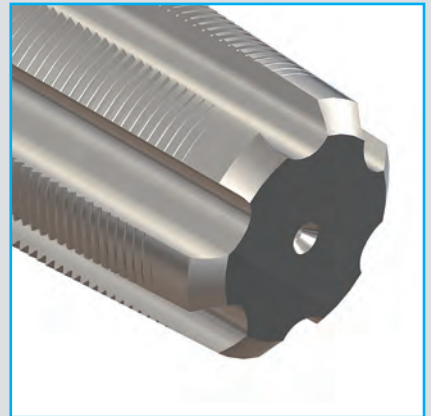
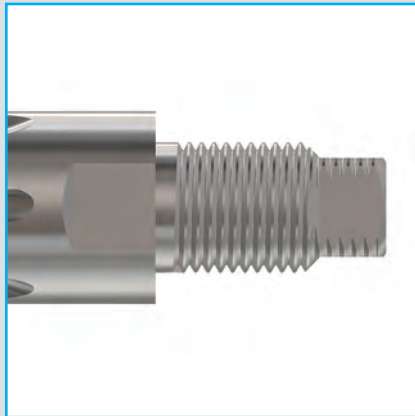

N USO GENERALE
General purpose - Usage Général

MASCHI A MACCHINA
MACHINE TAPS - TARAUDS MACHINE

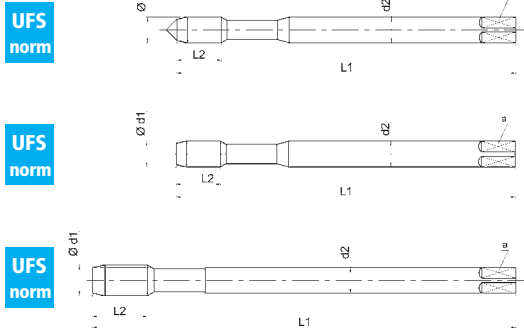

60° P
RH
C 2-3
Rm 850
GAMBO SHANK XL
CO



Profond. di filettatura - Thread depth - Profond. de filetage
Materiale - Material - Matériau
Tolleranza - Tolerance - Tolérance
Trattamento superficiale - Surface treatment - Revêtement
Numero gruppi materiali
Material's groups number
Nombre de groupes du matériau

2,5xD	2,5xD
HSSE	HSSE
ISO2/6H	ISO2/6H
BR	TiCN
1.1 1.2 1.3 1.4	1.1 1.2 1.3 1.4
4.1 4.2	2.1 2.2 3.3 3.4
5.1 5.2	4.2 4.3
	5.2

UFS norm	Ød1 M	P mm	L1	L2	d2 h9	a h12	Z	
4	0,7	125	7	4,5	3,4	3	3,3	
5	0,8	140	8	6	4,9	3	4,2	
6	1	160	10	6	4,9	3	5	
8	1,25	180	13	8	6,2	3	6,8	
10	1,5	180	16	10	8	3	8,5	

CODICE - CODE	
L60M...	L60M...CT
<input type="radio"/>	<input type="radio"/>
<input type="radio"/>	<input type="radio"/>
<input type="radio"/>	<input type="radio"/>
<input type="radio"/>	<input type="radio"/>
<input type="radio"/>	<input type="radio"/>

UFS norm	Ød1 M	P mm	L1	L2	d2 h9	a h12	Z	
12	1,75	225	23	9	7	3	10,3	
14	2	225	23	11	9	3	12	
16	2	225	23	12	9	4	14	

CODICE - CODE	
L61M...	L61M... CT
<input type="radio"/>	<input type="radio"/>
<input type="radio"/>	<input type="radio"/>
<input type="radio"/>	<input type="radio"/>

M Filettatura metrica ISO passo grosso DIN 13

ISO Metric coarse thread DIN 13
 Metrisches ISO-Regelgewinde DIN13 – Maschinengewindebohrer
 Filetage métrique ISO DIN 13 – Tarauds machine
 Rosca ISO métrica regular DIN13 – Machos de rosca a máquina



MASCHI A MACCHINA

MACHINE TAPS - TARAUDS MACHINE

Al-Cu-Fe

ALLUMINIO, RAME, ACCIAIO R ≤ 700 N/mm²
 Al, Cu, Steel R ≤ 700 N/mm² - Al, Cu, Acier R ≤ 700 N/mm²

DIN 371

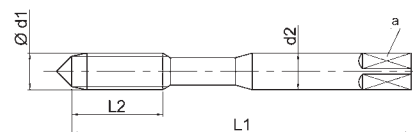

DIN 376

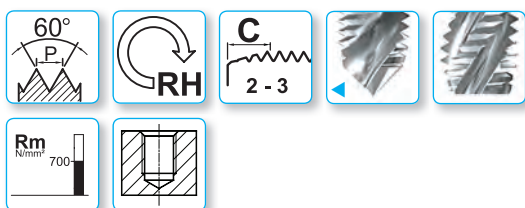
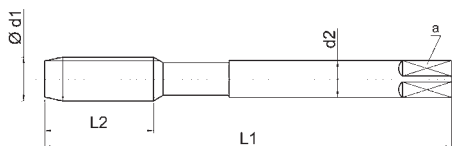

LINE



R45°

LINE



R45°

TOP



R45°

LINE



R45°

Profond. di filettatura - Thread depth - Profond. de filetage

Materiale - Material - Matériau

Tolleranza - Tolerance - Tolérance

Trattamento superficiale - Surface treatment - Revêtement

Numero gruppi materiali

Material's groups number

Nombre de groupes du matériau

3xD

HSSE

ISO2/6H

BR

1.1 4.1 4.2

5.1 5.2

6.1 7.1

8.1

3xD

HSSE

ISO2/6H

VS

1.1

4.1 4.2

5.1 5.2

8.1

3xD

HSSE

ISO2/6H

TXC

1.1

4.1 4.2 4.3

5.1 5.2

3xD

HSSE

ISO2/6H

ZrN

1.1

4.1 4.2 4.3

5.1 5.2

DIN 371	Ød1 M	P mm	L1	L2	d2 h9	a h12	Z	
◀	3	0,5	56	10	3,5	2,7	2	2,5
◀	4	0,7	63	13	4,5	3,4	2	3,3
◀	5	0,8	70	13	6	4,9	2	4,2
◀	6	1	80	16	6	4,9	2	5
◀	8	1,25	90	18	8	6,2	2	6,8
◀	10	1,5	100	20	10	8	2	8,5

E70M...	CODICE - CODE		
	E70M...VS	E70M...TXC	E70M...TZ
•	○	○	○
•	○	○	○
•	○	○	○
•	○	○	○
•	○	○	○
•	○	○	○

DIN 376	Ød1 M	P mm	L1	L2	d2 h9	a h12	Z	
◀	6	1	80	16	4,5	3,4	2	5
◀	8	1,25	90	18	6	4,9	2	6,8
◀	10	1,5	100	20	7	5,5	2	8,5
	12	1,75	110	25	9	7	3	10,3
	14	2	110	28	11	9	3	12
	16	2	110	28	12	9	3	14

E71M...	CODICE - CODE		
	E71M...VS	E71M...TXC	E71M...TZ
○	○	○	-
○	○	○	-
○	○	○	-
•	○	○	○
•	○	○	○
•	○	○	○

Confezione / Box / Colis:
 M3 – M10: 10 pezzi / pcs
 M12 – M16: 5 pezzi / pcs

€ Pag. listino - Price list - Liste des prix

31

31

31

31

• Standard

○ Disponibilità da richiedere, prezzo a listino
 On enquiry, standard price-list / Stock à vérifier

★ Solo a richiesta
 Only on request / Sur demande

Al-Cu-Fe
ALLUMINIO, RAME, ACCIAIO R ≤ 700 N/mm²
Al, Cu, Steel R ≤ 700 N/mm² - Al, Cu, Acier R ≤ 700 N/mm²
MASCHI A MACCHINA

MACHINE TAPS - TARAUDS MACHINE

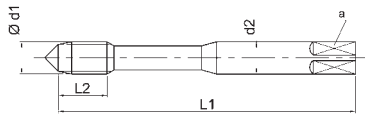
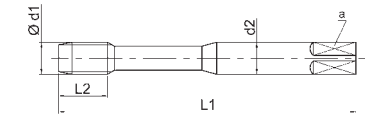
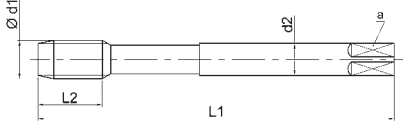
DIN 371

DIN 371

DIN 376

LINE



R40°



Profond. di filettatura - Thread depth - Profond. de filetage

2,5xD

Materiale - Material - Matériau

HSSE

Tolleranza - Tolerance - Tolérance

ISO2/6H

Trattamento superficiale - Surface treatment - Revêtement

CrN

Numero gruppi materiali

Material's groups number

Nombre de groupes du matériau

1.1 1.2 1.3 1.4

5.1 5.2

DIN 371	Ød1 M	P mm	L ₁	L ₂	d ₂ h9	a h12	Z	
◀	3	0,5	56	5	3,5	2,7	3	2,5
◀	4	0,7	63	7	4,5	3,4	3	3,3
◀	5	0,8	70	8	6	4,9	3	4,2
◀	6	1	80	10	6	4,9	3	5
	8	1,25	90	13	8	6,2	3	6,8
	10	1,5	100	15	10	8	3	8,5

E60M...NC		CODICE - CODE	
○			
○			
○			
○			
○			
○			

DIN 376	Ød1 M	P mm	L ₁	L ₂	d ₂ h9	a h12	Z	
	6	1	80	10	4,5	3,4	3	5
	8	1,25	90	13	6	4,9	3	6,8
	10	1,5	100	15	7	5,5	3	8,5
	12	1,75	110	18	9	7	3	10,3
	14	2	110	20	11	9	3	12
	16	2	110	20	12	9	4	14
	18	2,5	125	25	14	11	4	15,5
	20	2,5	140	25	16	12	4	17,5
	22	2,5	140	25	18	14,5	4	19,5
	24	3	160	30	18	14,5	4	21
	27	3	160	30	20	16	4	24
	30	3,5	180	35	22	18	4	26,5

E61M...NC		CODICE - CODE	
○			
○			
○			
○			
○			
○			
○			
○			
○			
○			
○			
○			

Confezione / Box / Colis: M3 – M10: 10 pezzi / pcs M12 – M16: 5 pezzi / pcs	€ Pag. listino - Price list - Liste des prix 32 ● Standard	○ Disponibilità da richiedere, prezzo a listino On enquiry, standard price-list / Stock à vérifier	★ Solo a richiesta Only on request / Sur demande
---	--	---	---

Filettatura metrica ISO passo grosso DIN 13**ISO Metric coarse thread DIN 13**

Metrisches ISO-Regelgewinde DIN13 – Maschinengewindebohrer

Filetage métrique ISO DIN 13 – Tarauds machine

Rosca ISO métrica regular DIN13 – Machos de rosca a máquina

N

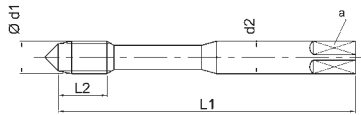
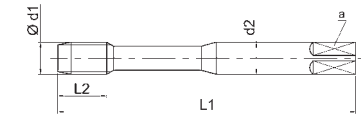
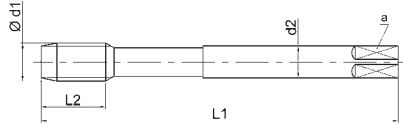
USO GENERALE R ≤ 1000N/mm²General purpose R ≤ 1000N/mm² - Usage Général R ≤ 1000N/mm²**MASCHI A MACCHINA****MACHINE TAPS - TARAUDS MACHINE**DIN
371DIN
371DIN
376

plus



R40°

plus



R40°

plus



R40°

plus



R40°

Profond. di filettatura - Thread depth - Profond. de filetage

Materiale - Material - Matériau

Tolleranza - Tolerance - Tolérance

Trattamento superficiale - Surface treatment - Revêtement

Numero gruppi materiali

Material's groups number

Nombre de groupes du matériau

2,5xD

HSSP

ISO2/6H

BR

1.1 1.2 1.3 1.4

4.1 4.2

5.1 5.2

2,5xD

HSSP

ISO2/6H

V

1.1 1.2 1.3 1.4

4.1 4.2

5.1 5.2

2,5xD

HSSP

ISO2/6H

TiN

1.1 1.2 1.3 1.4 1.5

3.3 3.4 4.1 4.2 4.3

5.1 5.2

2,5xD

HSSP

ISO2/6H

XP

1.1 1.2 1.3 1.4 1.5

2.1 2.2

3.3 3.4 4.2 4.3

5.2

DIN 371	Ød1 M	P mm	L1	L2	d2 h9	a h12	Z	
3	0,5	56	5	3,5	2,7	3	2,5	
4	0,7	63	7	4,5	3,4	3	3,3	
5	0,8	70	8	6	4,9	3	4,2	
6	1	80	10	6	4,9	3	5	
8	1,25	90	13	8	6,2	3	6,8	
10	1,5	100	15	10	8	3	8,5	

DIN 376	Ød1 M	P mm	L1	L2	d2 h9	a h12	Z	
12	1,75	110	18	9	7	4	10,3	
14	2	110	20	11	9	4	12	
16	2	110	20	12	9	4	14	
18	2,5	125	25	14	11	4	15,5	
20	2,5	140	25	16	12	4	17,5	
22	2,5	140	25	18	14,5	4	19,5	
24	3	160	30	18	14,5	4	21	
27	3	160	30	20	16	4	24	
30	3,5	180	35	22	18	4	26,5	

CODICE - CODE

P60M...

P60M...V

P60M...T

P60M...XP

*

*

*

*

○

○

○

○

○

○

○

○

○

○

○

○

○

○

○

○

CODICE - CODE

P61M...

P61M...V

P61M...T

P61M...XP

○

○

○

○

*

*

*

*

*

*

*

*

*

*

*

*

*

*

*

*

*

*

*

*

*

*

*

*

*

*

*

*



Solo a richiesta

Only on request / Sur demande

RACCOMANDATO per filettatura rigida

We recommend Syncro rigid threading:

Recommandé pour le taraudage rigide

 Confezione / Box / Colis:
 M3 – M10: 10 pezzi / pcs
 M12 – M16: 5 pezzi / pcs

€ Pag. listino - Price list - Liste des prix

32

32

32

32

● Standard

○ Disponibilità da richiedere, prezzo a listino
On enquiry, standard price-list / Stock à vérifier

N USO GENERALE R ≤ 1000N/mm²
 General purpose R ≤ 1000N/mm² - Usage Général R ≤ 1000N/mm²

MASCHI A MACCHINA
 MACHINE TAPS - TARAUDS MACHINE

DIN 371

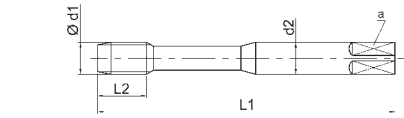

DIN 376

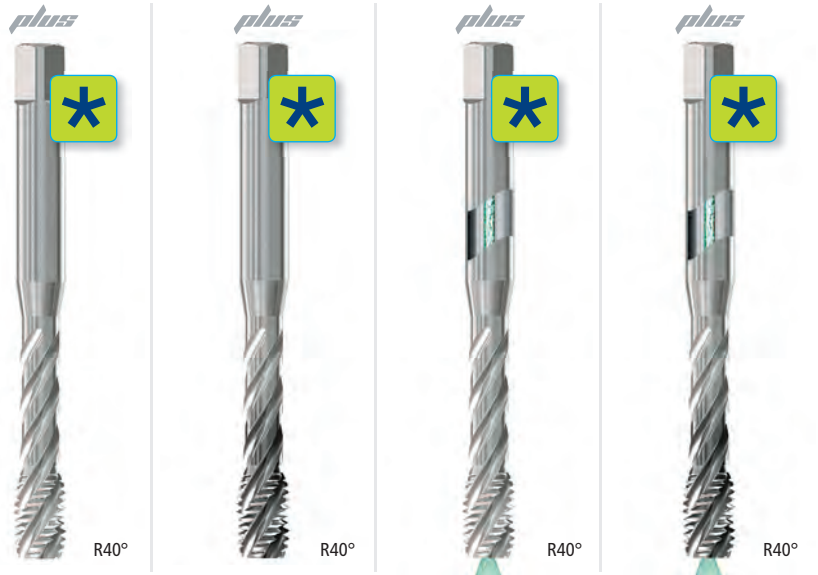
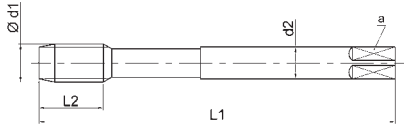

Profond. di filettatura - Thread depth - Profond. de filetage	2,5xD	2,5xD	3xD	3xD
Materiale - Material - Matériau	HSSP	HSSP	HSSP	HSSP
Tolleranza - Tolerance - Tolérance	ISO2/6H	ISO2/6H	ISO2/6H	ISO2/6H
Trattamento superficiale - Surface treatment - Revêtement	BR	XP	BR	XP
Numero gruppi materiali Material's groups number Nombre de groupes du matériau	1.1 1.2 1.3 1.4	1.1 1.2 1.3 1.4 1.5	1.1 1.2 1.3 1.4	1.1 1.2 1.3 1.4 1.5
	4.1 4.2	2.1 2.2	4.1 4.2	2.1 2.2
	5.1 5.2	3.3 3.4 4.2 4.3	5.1 5.2	3.3 3.4 4.2 4.3
		5.2		5.2

DIN 371	Ød1 M	P mm	L1	L2	d2 h9	a h12	Z	
	4	0,7	63	7	4,5	3,4	3	3,3
	5	0,8	70	8	6	4,9	3	4,2
	6	1	80	10	6	4,9	3	5
	8	1,25	90	13	8	6,2	3	6,8
	10	1,5	100	15	10	8	3	8,5

CODICE - CODE			
P60EM...	P60EM...XP	P60EM...FOR	P60EM...FOR-XP
*	*	-	-
o	o	-	-
o	o	o	o
o	o	o	o
o	o	o	o

DIN 376	Ød1 M	P mm	L1	L2	d2 h9	a h12	Z	
	12	1,75	110	18	9	7	4	10,3
	14	2	110	20	11	9	4	12
	16	2	110	20	12	9	4	14

CODICE - CODE			
P61EM...	P61EM...XP	P61EM...FOR	P61EM...FOR-XP
o	o	o	o
o	o	o	o
o	o	o	o

RACCOMANDATO per filettatura rigida
 We recommend Syncro rigid threading:
 Recommandé pour le taraudage rigide

***** Ad esaurimento scorte
 Stock clearance - Stock épuisé

Vedi nuova serie - See new series - Voir nouvelle série
 E94-E95 pag. XXXIII

Confezione / Box / Colis: M3 – M10: 10 pezzi / pcs M12 – M16: 5 pezzi / pcs	€ Pag. listino - Price list - Liste des prix	33	33	33	33
	• Standard	o	Disponibilità da richiedere, prezzo a listino On enquiry, standard price-list / Stock à vérifier	*	Solo a richiesta Only on request / Sur demande

Filettatura metrica ISO passo grosso DIN 13

ISO Metric coarse thread DIN 13

Metrisches ISO-Regelgewinde DIN13 – Maschinengewindebohrer

Filetage métrique ISO DIN 13 – Tarauds machine

Rosca ISO métrica regular DIN13 – Machos de roscar a máquina

N

USO GENERALE

General purpose - Usage Général

MASCHI A MACCHINA

MACHINE TAPS - TARAUDS MACHINE

DIN 371

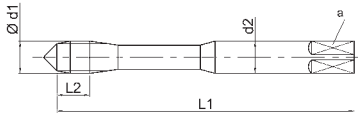

DIN 371

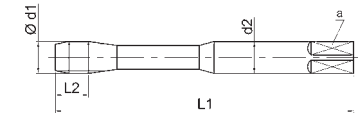

DIN 376

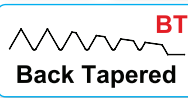
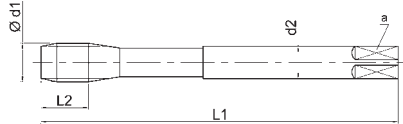

LINE



R40°

LINE



R40°

LINE



R40°

LINE



R40°

Profond. di filettatura - Thread depth - Profond. de filetage

2,5÷3xD

2,5÷3xD

2,5÷3xD

2,5÷3xD

Materiale - Material - Matériau

HSSE

HSSE

HSSE

HSSE

Tolleranza - Tolerance - Tolérance

ISO2/6H

ISO2/6H

ISO2/6H

ISO2/6H

Trattamento superficiale - Surface treatment - Revêtement

BR

V

TiN

XP

Numero gruppi materiali

Material's groups number

Nombre de groupes du matériau

1.1 1.2 1.3 1.4

1.1 1.2 1.3 1.4

1.1 1.2 1.3 1.4

1.1 1.2 1.3 1.4

5.1 5.2

2.1 2.2

5.1 5.2

2.1 2.2

5.2

DIN 371	$\varnothing d_1$ M	P mm	L_1	L_2	d_2 h9	a h12	Z	
3	0,5	56	5	3,5	2,7	3	2,5	
4	0,7	63	7	4,5	3,4	3	3,3	
5	0,8	70	8	6	4,9	3	4,2	
6	1	80	10	6	4,9	3	5	
8	1,25	90	13	8	6,2	3	6,8	
10	1,5	100	15	10	8	3	8,5	

DIN 376	$\varnothing d_1$ M	P mm	L_1	L_2	d_2 h9	a h12	Z	
8	1,25	90	13	6	4,9	3	6,8	
10	1,5	100	15	7	5,5	3	8,5	
12	1,75	110	18	9	7	3	10,3	
14	2	110	20	11	9	3	12	
16	2	110	20	12	9	4	14	
18	2,5	125	25	14	11	4	15,5	
20	2,5	140	25	16	12	4	17,5	
22	2,5	140	25	18	14,5	4	19,5	
24	3	160	30	18	14,5	4	21	
27	3	160	30	20	16	4	24	
30	3,5	180	35	22	18	4	26,5	

CODICE - CODE

E80M...

E80M...V

E80M...T

E80M...XP

•

○

○

○

•

○

○

○

•

•

•

•

•

•

•

•

•

•

•

•

CODICE - CODE

E81M...

E81M...V

E81M...T

E81M...XP

○

○

○

○

○

○

○

○

•

•

•

•

•

•

•

•

•

•

•

•

○

○

○

○

•

○

○

○

•

○

○

○

•

○

○

○

Per filettatura rigida
Syncro rigid threading
Pour le taraudage rigide



Ad esaurimento scorte
Stock clearance - Stock épuisé

Vedi nuova serie - See new series - Voir nouvelle série: E92-E93 pag. XXXI

Confezione / Box / Colis:
M3 – M10: 10 pezzi / pcs
M12 – M16: 5 pezzi / pcs

€ Pag. listino - Price list - Liste des prix

33

33

34

34

• Standard

○ Disponibilità da richiedere, prezzo a listino
On enquiry, standard price-list / Stock à vérifier

★ Solo a richiesta
Only on request / Sur demande

N **USO GENERALE**
General purpose - Usage Général

MASCHI A MACCHINA
MACHINE TAPS - TARAUDS MACHINE

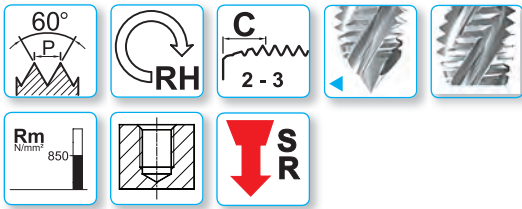
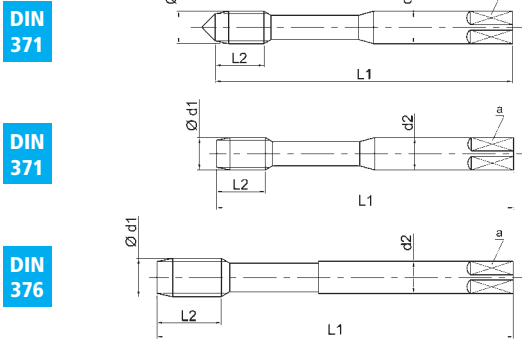

Profond. di filettatura - Thread depth - Profond. de filetage
Materiale - Material - Matériau
Tolleranza - Tolerance - Tolérance
Trattamento superficiale - Surface treatment - Revêtement
Numero gruppi materiali
Material's groups number
Nombre de groupes du matériau

3xD	3xD	3xD	3xD
HSSE	HSSE	HSSE	HSSE
ISO2/6H	ISO2/6H	ISO2/6H	ISO2/6H
BR	V	TiN	XP
1.1 1.2 1.3 1.4	1.1 1.2 1.3 1.4	1.1 1.2 1.3 1.4	1.1 1.2 1.3 1.4
4.2 5.2	2.1 2.2	4.2 5.2	2.1 2.2
	4.2 5.2		4.2 5.2

DIN 371	Ød1 M	P mm	L1	L2	d2 h9	a h12	Z	
3	0,5	56	5	3,5	2,7	3	2,5	
4	0,7	63	7	4,5	3,4	3	3,3	
5	0,8	70	8	6	4,9	3	4,2	
6	1	80	10	6	4,9	3	5	
8	1,25	90	13	8	6,2	3	6,8	
10	1,5	100	15	10	8	3	8,5	

CODICE - CODE			
E82M...	E82M...V	E82M...T	E82M...XP
<input type="checkbox"/>	<input type="checkbox"/>	<input type="checkbox"/>	<input type="checkbox"/>
<input type="checkbox"/>	<input type="checkbox"/>	<input type="checkbox"/>	<input type="checkbox"/>
<input type="checkbox"/>	<input type="checkbox"/>	<input type="checkbox"/>	<input type="checkbox"/>
<input type="checkbox"/>	<input type="checkbox"/>	<input type="checkbox"/>	<input type="checkbox"/>
<input type="checkbox"/>	<input type="checkbox"/>	<input type="checkbox"/>	<input type="checkbox"/>
<input type="checkbox"/>	<input type="checkbox"/>	<input type="checkbox"/>	<input type="checkbox"/>

DIN 376	Ød1 M	P mm	L1	L2	d2 h9	a h12	Z	
12	1,75	110	18	9	7	4	10,3	
14	2	110	20	11	9	4	12	
16	2	110	20	12	9	4	14	
18	2,5	125	25	14	11	4	15,5	
20	2,5	140	25	16	12	4	17,5	
22	2,5	140	25	18	14,5	4	19,5	
24	3	160	30	18	14,5	4	21	

CODICE - CODE			
E83M...	E83M...V	E83M...T	E83M...XP
<input type="checkbox"/>	<input type="checkbox"/>	<input type="checkbox"/>	<input type="checkbox"/>
<input type="checkbox"/>	<input type="checkbox"/>	<input type="checkbox"/>	<input type="checkbox"/>
<input type="checkbox"/>	<input type="checkbox"/>	<input type="checkbox"/>	<input type="checkbox"/>
<input type="checkbox"/>	<input type="checkbox"/>	<input type="checkbox"/>	<input type="checkbox"/>
<input type="checkbox"/>	<input type="checkbox"/>	<input type="checkbox"/>	<input type="checkbox"/>
<input type="checkbox"/>	<input type="checkbox"/>	<input type="checkbox"/>	<input type="checkbox"/>
<input type="checkbox"/>	<input type="checkbox"/>	<input type="checkbox"/>	<input type="checkbox"/>

***** Ad esaurimento scorte
Stock clearance - Stock épuisé

RACCOMANDATO per filettatura rigida
We recommend Syncro rigid threading
Recommandé pour le taraudage rigide

Versione ad alto rendimento in PM3 pagina seguente.
High performance PM3 edition in following page.
Version haut performance en PM3: page suivante.

Confezione / Box / Colis: M3 – M10: 10 pezzi / pcs M12 – M16: 5 pezzi / pcs	€ Pag. listino - Price list - Liste des prix	34	34	34	34
	• Standard	<input type="checkbox"/> Disponibilità da richiedere, prezzo a listino On enquiry, standard price-list / Stock à vérifier		<input type="checkbox"/> Solo a richiesta Only on request / Sur demande	

M Filettatura metrica ISO passo grosso DIN 13

ISO Metric coarse thread DIN 13

Metrisches ISO-Regelgewinde DIN13 – Maschinengewindebohrer

Filetage métrique ISO DIN 13 – Tarauds machine

Rosca ISO métrica regular DIN13 – Machos de rosca a máquina



U

APPLICAZIONI UNIVERSALI R ≤ 1200 N/mm²

Universal R ≤ 1200 N/mm² - Universal R ≤ 1200 N/mm²

MASCHI A MACCHINA

MACHINE TAPS - TARAUDS MACHINE

DIN 371

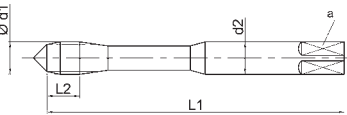

DIN 371

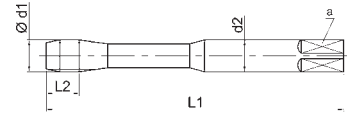

DIN 376

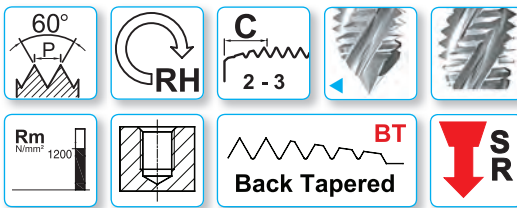
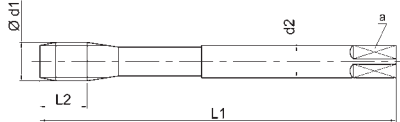

Profond. di filettatura - Thread depth - Profond. de filetage

Materiale - Material - Matériau

Tolleranza - Tolerance - Tolérance

Trattamento superficiale - Surface treatment - Revêtement

Numero gruppi materiali

Material's groups number

Nombre de groupes du matériau

TOP



BT

R45°

TOP



BT

R45°

TOP



BT

R45°

3xD

3,5xD

3,5xD

PM3

PM3

PM3

6HX

6HX

6HX

XP

XP

XP

1.1 1.2 1.3 1.4 1.5

1.1 1.2 1.3 1.4 1.5

1.1 1.2 1.3 1.4 1.5

2.1 2.2 2.3

2.1 2.2 2.3

2.1 2.2 2.3

3.3 3.4 4.2 4.3

3.3 3.4 4.2 4.3

3.3 3.4 4.2 4.3

5.2

5.2

5.2

DIN 371	Ød1 M	P mm	L1	L2	d2 h9	a h12	Z	
3	0,5	56	5	3,5	2,7	3	2,5	
4	0,7	63	7	4,5	3,4	3	3,3	
5	0,8	70	8	6	4,9	3	4,2	
6	1	80	10	6	4,9	3	5	
8	1,25	90	13	8	6,2	3	6,8	
10	1,5	100	15	10	8	3	8,5	

K82M...XP	CODICE - CODE	
	K82M...FOR-XP	K82M...FORY-XP
•	-	-
•	-	-
•	-	-
•	○	○
•	○	○
•	○	○

DIN 376	Ød1 M	P mm	L1	L2	d2 h9	a h12	Z	
12	1,75	110	18	9	7	4	10,3	
14	2	110	20	11	9	4	12	
16	2	110	20	12	9	4	14	
18	2,5	125	25	14	11	4	15,5	
20	2,5	140	25	16	12	4	17,5	
22	2,5	140	25	18	14,5	4	19,5	
24	3	160	30	18	14,5	4	21	
27	3	160	30	20	16	4	24	
30	3,5	180	35	22	18	4	26,5	

K83M...XP	CODICE - CODE	
	K83M...FOR-XP	K83M...FORY-XP
•	○	○
•	○	○
•	○	○
○	○	○
○	○	○
○	○	○
○	○	○
○	○	○

RACCOMANDATO per filettatura rigida
We recommend Syncro rigid threading:
Recommandé pour le taraudage rigide

Confezione / Box / Colis:
M3 – M10: 10 pezzi / pcs
M12 – M16: 5 pezzi / pcs

€ Pag. listino - Price list - Liste des prix

35

35

35

• Standard

○ Disponibilità da richiedere, prezzo a listino
On enquiry, standard price-list / Stock à vérifier

★ Solo a richiesta
Only on request / Sur demande

SYNCHRO RIGID

MASCHIATURA RIGIDA SINCRONIZZATA

Rigid Tapping Synchro - Taraudage rigide synchronisé

MASCHI A MACCHINA

MACHINE TAPS - TARAUDS MACHINE

DIN 371

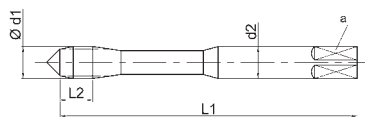

DIN 371

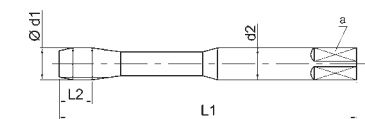

UFS norm

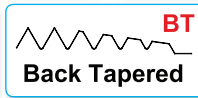
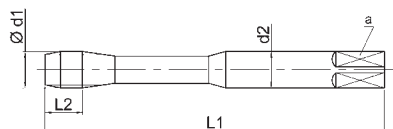

top



BT

R40°

top



BT

R40°

Profond. di filettatura - Thread depth - Profond. de filetage

2,5xD

3xD

Materiale - Material - Matériau

PM3

PM3

Tolleranza - Tolerance - Tolérance

6HX

6HX

Trattamento superficiale - Surface treatment - Revêtement

TXC

TXC

Numero gruppi materiali

Material's groups number

Nombre de groupes du matériau

1.1 1.2 1.3 1.4 1.5

2.1 2.2 2.3 2.4 3.3 3.4

4.2 4.3 5.2

DIN 371	Ød1 M	P mm	L1	L2 10xP	d2 h6	a h12	Z	
6	1	80	10	6	4,9	3	5	
8	1,25	90	13	8	6,2	3	6,8	
10	1,5	100	15	10	8	3	8,5	

CODICE - CODE	
S80M...TXC	S80M...FOR-TXC
<input type="radio"/>	<input type="radio"/>
<input type="radio"/>	<input type="radio"/>
<input type="radio"/>	<input type="radio"/>

UFS norm	Ød1 M	P mm	L1	L2 10xP	d2 h6	a h12	Z	
12	1,75	110	18	12	9	3	10,3	
14	2	110	20	12	9	3	12	
16	2	110	20	16	12	4	14	

RACCOMANDATO per filettatura rigida

We recommend Synchro rigid threading:

Recommandé pour le taraudage rigide

CODICE - CODE	
S80M...TXC	S80M...FOR-TXC
<input type="radio"/>	<input type="radio"/>
<input type="radio"/>	<input type="radio"/>
<input type="radio"/>	<input type="radio"/>

A richiesta:
On request:
Sur demande:
Con **Weldon** DIN1835 B

Filettatura metrica ISO passo grosso DIN 13**ISO Metric coarse thread DIN 13**

Metrisches ISO-Regelgewinde DIN13 – Maschinengewindebohrer

Filetage métrique ISO DIN 13 – Tarauds machine

Rosca ISO métrica regular DIN13 – Machos de roscar a máquina

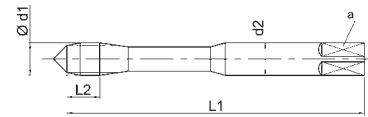
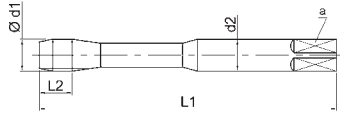
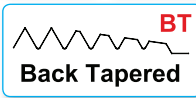
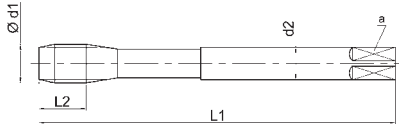
MASCHI A MACCHINA**MACHINE TAPS - TARAUDS MACHINE****DIN 371****DIN 371****DIN 376****Back Tapered**

TOP



BT

R25°

TOP



BT

R25°

TOP



BT

R25°

Profond. di filettatura - Thread depth - Profond. de filetage

Materiale - Material - Matériau

Tolleranza - Tolerance - Tolérance

Trattamento superficiale - Surface treatment - Revêtement

Acciai legati trattati
Alloyed steel - tempered steel
Aciers alliés traités
Fusioni d'acciaio
Steel castings / Fusions d'acier

Numero gruppi materiali
Material's groups number
Nombre de groupes du matériau

2,5xD**PM3****6HX****BR**

1.4 1.5

3.3 3.4

2,5xD**PM3****6HX****TiCN**

1.4 1.5

3.3 3.4

3xD**PM3****6HX****TiCN**

1.4 1.5

3.3 3.4

DIN 371	Ød1 M	P mm	L1	L2	d2 h9	a h12	Z	
4	0,7	63	13	4,5	3,4	3	3,3	
5	0,8	70	13	6	4,9	3	4,2	
6	1	80	16	6	4,9	3	5	
8	1,25	90	18	8	6,2	3	6,8	
10	1,5	100	20	10	8	3	8,5	

DIN 376	Ød1 M	P mm	L1	L2	d2 h9	a h12	Z	
12	1,75	110	25	9	7	4	10,3	
14	2	110	28	11	9	4	12	
16	2	110	28	12	9	4	14	

CODICE - CODE		
K28M...	K28M...CT	K28M...FOR-CT
○	○	-
○	○	-
○	○	○
○	○	○
○	○	○

CODICE - CODE		
K29M...	K29M...CT	K29M...FOR-CT
○	○	○
*	*	*
○	○	○

Confezione / Box / Colis:
M3 – M10: 10 pezzi / pcs
M12 – M16: 5 pezzi / pcs

€ Pag. listino - Price list - Liste des prix

36**36****36**

● Standard

○ Disponibilità da richiedere, prezzo a listino
On enquiry, standard price-list / Stock à vérifier★ Solo a richiesta
Only on request / Sur demande

HR ALTA RESISTENZA
High Resistance - Haute Résistance

MASCHI A MACCHINA
MACHINE TAPS - TARAUDS MACHINE

DIN 371

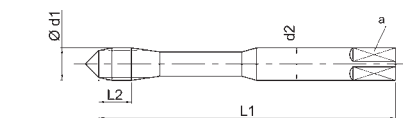

DIN 371

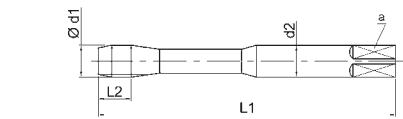

DIN 376

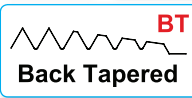
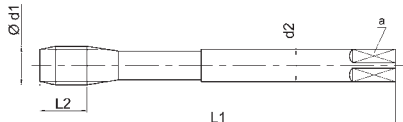

TOP



TOP



Profond. di filettatura - Thread depth - Profond. de filetage

Materiale - Material - Matériau

Tolleranza - Tolerance - Tolérance

Trattamento superficiale - Surface treatment - Revêtement

Numero gruppi materiali
Material's groups number
Nombre de groupes du matériau

2,5xD

3xD

PM3

PM3

6HX

6HX

TXC

TXC

1.4 1.5

1.4 1.5

3.3 3.4

3.3 3.4

DIN 371	Ød1 M	P mm	L ₁	L ₂	d ₂ h9	a h12	Z	
3	0,5	56	5	3,5	2,7	3	2,5	
4	0,7	63	7	4,5	3,4	3	3,3	
5	0,8	70	8	6	4,9	3	4,2	
6	1	80	10	6	4,9	3	5	
8	1,25	90	13	8	6,2	3	6,8	
10	1,5	100	15	10	8	3	8,5	

CODICE - CODE	
K80M...TXC	K80M...FOR-TXC
•	-
•	-
•	-
•	○
•	○
•	○

DIN 376	Ød1 M	P mm	L ₁	L ₂	d ₂ h9	a h12	Z	
12	1,75	110	18	9	7	4	10,3	
14	2	110	20	11	9	4	12	
16	2	110	20	12	9	4	14	

CODICE - CODE	
K81M...TXC	K81M...FOR-TXC
•	○
•	○
•	○

RACCOMANDATO per filettatura rigida
We recommend Syncro rigid threading
Recommandé pour le taraudage rigide



Confezione / Box / Colis:
M3 – M10: 10 pezzi / pcs
M12 – M16: 5 pezzi / pcs

€ Pag. listino - Price list - Liste des prix

36

36

• Standard

○ Disponibilità da richiedere, prezzo a listino
On enquiry, standard price-list / Stock à vérifier

★ Solo a richiesta
Only on request / Sur demande

M Filettatura metrica ISO passo grosso DIN 13

ISO Metric coarse thread DIN 13

Metrisches ISO-Regelgewinde DIN13 – Maschinengewindebohrer

Filetage métrique ISO DIN 13 – Tarauds machine

Rosca ISO métrica regular DIN13 – Machos de rosca a máquina



INOX

ACCIAIO INOSSIDABILE
Stainless steel - Acier inoxydable

MASCHI A MACCHINA

MACHINE TAPS - TARAUDS MACHINE

DIN 371

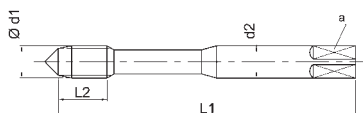

DIN 371

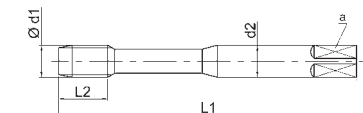

DIN 376

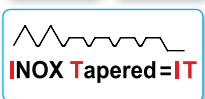

LINE



R48°

TOP



R48°

Profond. di filettatura - Thread depth - Profond. de filetage

Materiale - Material - Matériau

Tolleranza - Tolerance - Tolérance

Trattamento superficiale - Surface treatment - Revêtement

3,5xD

3,5xD

HSSV3

HSSV3

6HX

6HX

V

TXC

2.1 2.2 2.3

1.3 1.4 1.5

2.1 2.2 2.3 2.4

Numero gruppi materiali

Material's groups number

Nombre de groupes du matériau

DIN 371	Ød1 M	P mm	L1	L2	d2 h9	a h12	Z	
3	0,5	56	5	3,5	2,7	3	2,5	
4	0,7	63	7	4,5	3,4	3	3,3	
5	0,8	70	8	6	4,9	3	4,2	
6	1	80	10	6	4,9	3	5	
8	1,25	90	13	8	6,2	3	6,8	
10	1,5	100	15	10	8	3	8,5	

CODICE - CODE	
E80M...X-V	V82M...TXC
○	●
○	●
○	●
○	●
○	●
○	●

DIN 376	Ød1 M	P mm	L1	L2	d2 h9	a h12	Z	
12	1,75	110	18	9	7	3	10,3	
14	2	110	20	11	9	3	12	
16	2	110	20	12	9	4	14	
18	2,5	125	25	14	11	4	15,5	
20	2,5	140	25	16	12	4	17,5	
22	2,5	140	25	18	14,5	4	19,5	
24	3	160	30	18	14,5	4	21	

CODICE - CODE	
E81M...X-V	V83M...TXC
○	●
○	●
○	●
○	○
○	○
○	○



Ad esaurimento scorte
Stock clearance - Stock épuisé

Vedi nuova serie
See new series
Voir nouvelle série
E92-E93 pag. XXXI

RACCOMANDATO
per filettatura rigida

We recommend
Syncro rigid
threading

Recommandé
pour le
taraudage rigide



Confezione / Box / Colis:
M3 – M10: 10 pezzi / pcs
M12 – M16: 5 pezzi / pcs

€ Pag. listino - Price list - Liste des prix

37

37

● Standard

○ Disponibilità da richiedere, prezzo a listino
On enquiry, standard price-list / Stock à vérifier

★ Solo a richiesta
Only on request / Sur demande

INOX

ACCIAIO INOSSIDABILE
 Stainless steel - Acier inoxydable

MASCHI A MACCHINA

MACHINE TAPS - TARAUDS MACHINE

DIN 371

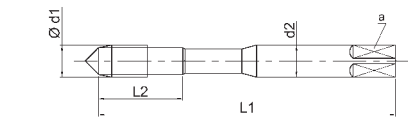

DIN 371

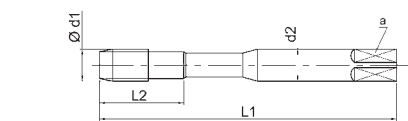

DIN 376

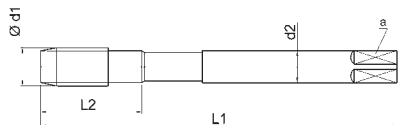

60° P
 RH
 C 2-3
 Rm Nmm² 1200
 INOX Tapered=IT
 SR

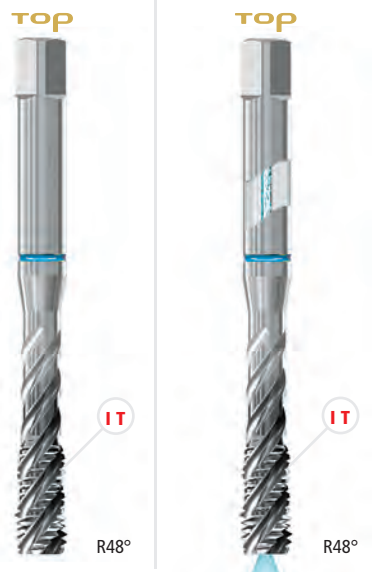

Profond. di filettatura - Thread depth - Profond. de filetage
 Materiale - Material - Matériau
 Tolleranza - Tolerance - Tolérance
 Trattamento superficiale - Surface treatment - Revêtement
 Numero gruppi materiali
 Material's groups number
 Nombre de groupes du matériau

3,5xD
 PM3
 6HX
 TXC
 1.3 1.4 1.5
 2.1 2.2 2.3 2.4

DIN 371	Ød1 M	P mm	L1	L2	d2 h9	a h12	Z	
3	0,5	56	10	3,5	2,7	3	2,5	
4	0,7	63	13	4,5	3,4	3	3,3	
5	0,8	70	13	6	4,9	3	4,2	
6	1	80	16	6	4,9	3	5	
8	1,25	90	18	8	6,2	3	6,8	
10	1,5	100	20	10	8	3	8,5	

CODICE - CODE	
K82M...X-TXC	K82M...XFOR-TXC
<input type="radio"/>	-
<input type="radio"/>	-
<input type="radio"/>	-
<input type="radio"/>	<input type="radio"/>
<input type="radio"/>	<input type="radio"/>
<input type="radio"/>	<input type="radio"/>

DIN 376	Ød1 M	P mm	L1	L2	d2 h9	a h12	Z	
12	1,75	110	25	9	7	3	10,3	
14	2	110	28	11	9	3	12	
16	2	110	28	12	9	4	14	

CODICE - CODE	
K83M...X-TXC	K83M...XFOR-TXC
<input type="radio"/>	<input type="radio"/>
<input type="radio"/>	<input type="radio"/>
<input type="radio"/>	<input type="radio"/>

RACCOMANDATO per filettatura rigida
 We recommend Syncro rigid threading
 Recommandé pour le taraudage rigide



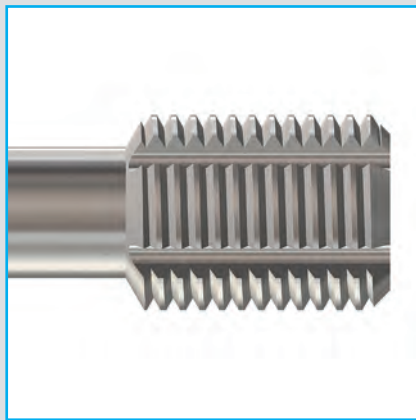

ROLL FORM TAPS



Filettatura metrica ISO passo grosso DIN 13

ISO Metric coarse thread DIN 13

Metrisches ISO-Regelgewinde DIN13 – Maschinengewindebohrer

Filetage métrique ISO DIN 13 – Tarauds machine

Rosca ISO métrica regular DIN13 – Machos de rosca a máquina

P - SERIES

MASCHI A RULLARE

Roll form taps - Tarauds à refolder

MASCHI A MACCHINA

MACHINE TAPS - TARAUDS MACHINE

DIN
371

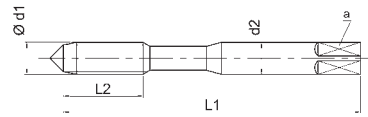

DIN
371

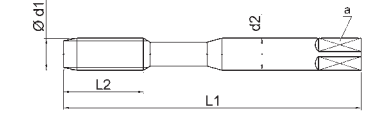

DIN
376

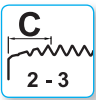
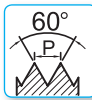
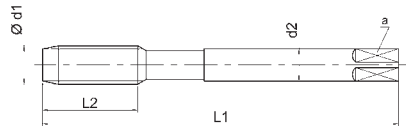

Profond. di filettatura - Thread depth - Profond. de filetage

Materiale - Material - Matériau

Tolleranza - Tolerance - Tolérance

Trattamento superficiale - Surface treatment - Revêtement

Numero gruppi materiali

Material's groups number

Nombre de groupes du matériau

LINE



LINE



LINE



3xD

3xD

3xD

HSSP

HSSP

HSSP

6HX

6HX

6HX

BR

V

TiN

1.1 1.2 1.3

1.1 1.2

1.1 1.2 1.3 1.4

4.1 4.2

4.1 4.2

2.1 2.2 2.3

5.1 5.2

4.1 4.2 4.3

5.1 5.2

DIN 371	$\varnothing d1$ M	P mm	L ₁	L ₂	d ₂ h ₉	a h ₁₂	Z	
◀	2	0,4	45	9	2,8	2,1	-	1,82
◀	2,5	0,45	50	9	2,8	2,1	-	2,30
◀	3	0,5	56	10	3,5	2,7	-	2,80
◀	3,5	0,6	56	11	4	3	-	3,25
◀	4	0,7	63	13	4,5	3,4	-	3,70
◀	5	0,8	70	13	6	4,9	-	4,65
◀	6	1	80	16	6	4,9	-	5,55
◀	8	1,25	90	18	8	6,2	-	7,40
◀	10	1,5	100	20	10	8	-	9,30
	8	1,25	90	18	8	6,2	-	7,40
	10	1,5	100	20	10	8	-	9,30

DIN 376	$\varnothing d1$ M	P mm	L ₁	L ₂	d ₂ h ₉	a h ₁₂	Z	
	12	1,75	110	25	9	7	-	11,20
	14	2	110	28	11	9	-	13,10
	16	2	110	28	12	9	-	15,10

P2SCM...	CODICE - CODE	
	P2SCM...V	P2SCM...T
•	○	•
○	○	○
•	○	•
○	○	○
•	○	•
•	○	•
•	○	•
•	○	•
•	○	•
•	○	•
•	○	•
P2SCM...SP	P2SCM...SP-V	P2SCM...SP-T
○	○	○
○	○	○

P2SCM...	CODICE - CODE	
	P2SCM...V	P2SCM...T
○	○	○
○	○	○
○	○	○



Ad esaurimento scorte
Stock clearance - Stock épuisé

Confezione / Box / Colis:
M3 - M10: 10 pezzi / pcs
M12 - M16: 5 pezzi / pcs

€ Pag. listino - Price list - Liste des prix

37

38

38

• Standard

○ Disponibilità da richiedere, prezzo a listino
On enquiry, standard price-list / Stock à vérifier

★ Solo a richiesta
Only on request / Sur demande

P - SERIES
MASCHI A RULLARE

Roll form taps - Tarauds à refouler

MASCHI A MACCHINA

MACHINE TAPS - TARAUDS MACHINE

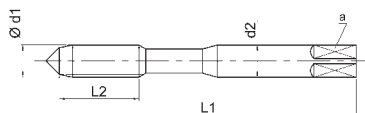
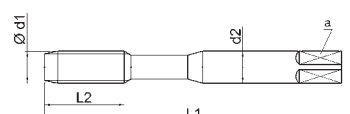
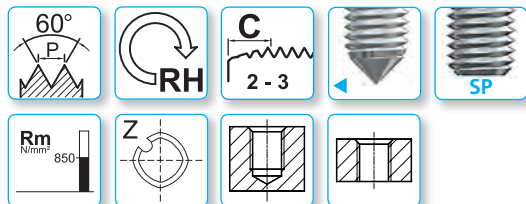
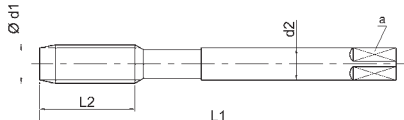
DIN 371

DIN 371

DIN 376

LINE

LINE

LINE

Profond. di filettatura - Thread depth - Profond. de filetage

Materiale - Material - Matériau

Tolleranza - Tolerance - Tolérance

Trattamento superficiale - Surface treatment - Revêtement

3xD	3xD	3xD
HSSP	HSSP	HSSP
6GX	6GX	6GX
BR	V	TiN
1.1 1.2 1.3	1.1 1.2	1.1 1.2 1.3 1.4
4.1 4.2	4.1 4.2	2.1 2.2 2.3
	5.1 5.2	4.1 4.2 4.3
		5.1 5.2

 Numero gruppi materiali
 Material's groups number
 Nombre de groupes du matériau

DIN 371	Ød1 M	P mm	L ₁	L ₂	d ₂ h ₉	a h ₁₂	Z	
3	0,5	56	10	3,5	2,7	2	2,80	
3,5	0,6	56	11	4	3	2	3,25	
4	0,7	63	13	4,5	3,4	4	3,70	
5	0,8	70	13	6	4,9	5	4,65	
6	1	80	16	6	4,9	5	5,55	
8	1,25	90	18	8	6,2	5	7,40	
10	1,5	100	20	10	8	5	9,30	
8	1,25	90	18	8	6,2	5	7,40	
10	1,5	100	20	10	8	5	9,30	

CODICE - CODE		
P3CCM...	P3CCM...V	P3CCM...T
<input type="radio"/>	<input type="radio"/>	<input type="radio"/>
<input type="radio"/>	<input type="radio"/>	<input type="radio"/>
<input type="radio"/>	<input type="radio"/>	<input type="radio"/>
<input type="radio"/>	<input type="radio"/>	<input type="radio"/>
<input type="radio"/>	<input type="radio"/>	<input type="radio"/>
<input type="radio"/>	<input type="radio"/>	<input type="radio"/>
P3CCM...SP	P3CCM...SP-V	P3CCM...SP-T
<input type="radio"/>	<input type="radio"/>	<input type="radio"/>
<input type="radio"/>	<input type="radio"/>	<input type="radio"/>

DIN 376	Ød1 M	P mm	L ₁	L ₂	d ₂ h ₉	a h ₁₂	Z	
12	1,75	110	25	9	7	5	11,20	
14	2	110	28	11	9	6	13,10	
16	2	110	28	12	9	6	15,10	

CODICE - CODE		
P3CCM...	P3CCM...V	P3CCM...T
<input type="radio"/>	<input type="radio"/>	<input type="radio"/>
<input type="radio"/>	<input type="radio"/>	<input type="radio"/>
<input type="radio"/>	<input type="radio"/>	<input type="radio"/>

★ Ad esaurimento scorte
 Stock clearance - Stock épuisé

Confezione / Box / Colis: M3 – M10: 10 pezzi / pcs M12 – M16: 5 pezzi / pcs	€ Pag. listino - Price list - Liste des prix • Standard	39 ○ Disponibilità da richiedere, prezzo a listino On enquiry, standard price-list / Stock à vérifier	39 ★ Solo a richiesta Only on request / Sur demande
---	--	---	---

Filettatura metrica ISO passo grosso DIN 13**ISO Metric coarse thread DIN 13**

Metrisches ISO-Regelgewinde DIN13 – Maschinengewindebohrer

Filetage métrique ISO DIN 13 – Tarauds machine

Rosca ISO métrica regular DIN13 – Machos de rosca a máquina

P - SERIES**MASCHI A RULLARE**

Roll form taps - Tarauds à refoiler

MASCHI A MACCHINA

MACHINE TAPS - TARAUDS MACHINE

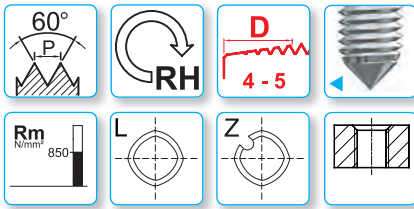
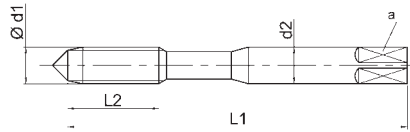
DIN 371

Profond. di filettatura - Thread depth - Profond. de filetage

Materiale - Material - Matériau

Tolleranza - Tolerance - Tolérance

Trattamento superficiale - Surface treatment - Revêtement

Numero gruppi materiali

Material's groups number

Nombre de groupes du matériau

LINE



LINE



LINE



LINE

**3xD****3xD****3xD****3xD****HSSP****HSSP****HSSP****HSSP****6HX****6HX****6HX****6HX****BR****TiN****BR****TiN**

1.1 1.2 1.3

1.1 1.2 1.3 1.4

1.1 1.2 1.3

1.1 1.2 1.3 1.4

4.1 4.2

2.1 2.2 2.3

4.1 4.2

2.1 2.2 2.3

4.1 4.2 4.3

4.1 4.2 4.3

5.1 5.2

5.1 5.2

DIN 371	Ød1 M	P mm	L ₁	L ₂	d ₂ h9	a h12	Z	
3	0,5	56	10	3,5	2,7	2	2,80	
4	0,7	63	13	4,5	3,4	4	3,70	
5	0,8	70	13	6	4,9	5	4,65	
6	1	80	16	6	4,9	5	5,55	
8	1,25	90	18	8	6,2	5	7,40	
10	1,5	100	20	10	8	5	9,30	

CODICE - CODE

P2SCM...FP

P2SCM...FP-T

P2CCM...FP

P2CCM...FP-T

*

*

*

*

*

*

*

*

*

*

*

*

*

*

*

*

*

*

*

*



Ad esaurimento scorte

Stock clearance - Stock épuisé

 Confezione / Box / Colis:
 M3 – M10: 10 pezzi / pcs
 M12 – M16: 5 pezzi / pcs

€ Pag. listino - Price list - Liste des prix

39**40****40****40**

● Standard

○ Disponibilità da richiedere, prezzo a listino
On enquiry, standard price-list / Stock à vérifier★ Solo a richiesta
Only on request / Sur demande

P - SERIES

MASCHI A RULLARE

Roll form taps - Tarauds à refouler

MASCHI A MACCHINA, FILETTATURA SINISTRA

LEFT THREAD MACHINE TAPS - TARAUDS MACHINE GAUCHE

DIN 371

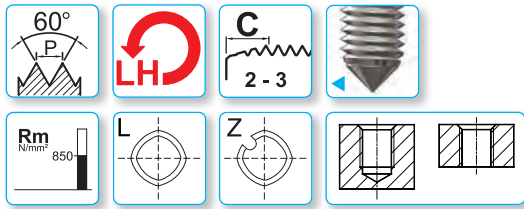
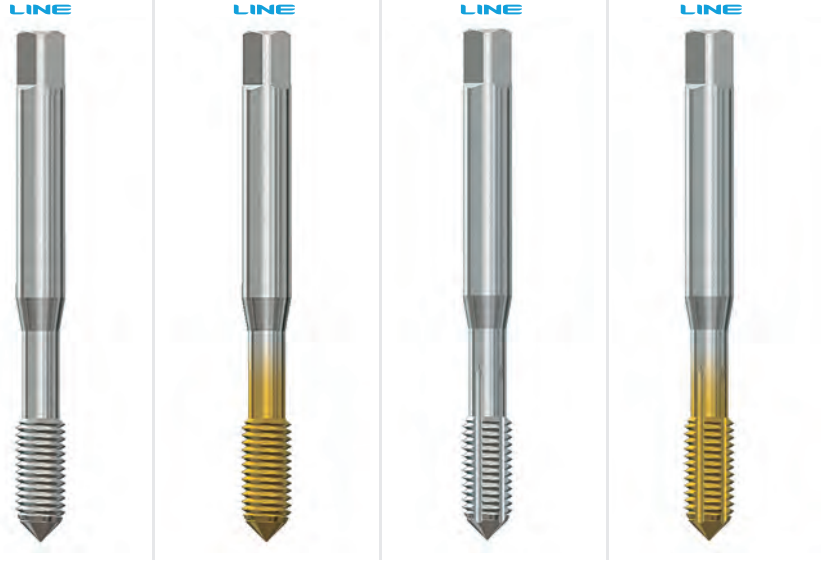
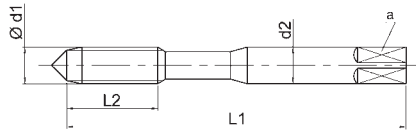

Profond. di filettatura - Thread depth - Profond. de filetage

Materiale - Material - Matériau

Tolleranza - Tolerance - Tolérance

Trattamento superficiale - Surface treatment - Revêtement

Numero gruppi materiali
Material's groups number
Nombre de groupes du matériau

3xD	3xD	3xD	3xD
HSSP	HSSP	HSSP	HSSP
6HX	6HX	6HX	6HX
BR	TiN	BR	TiN
1.1 1.2 1.3	1.1 1.2 1.3 1.4	1.1 1.2 1.3	1.1 1.2 1.3 1.4
4.1 4.2	2.1 2.2 2.3	4.1 4.2	2.1 2.2 2.3
	4.1 4.2 4.3		4.1 4.2 4.3
	5.1 5.2		5.1 5.2

DIN 371	Ød1 M	P mm	L1	L2	d2 h9	a h12	Z	
3	0,5	56	10	3,5	2,7	2	2,80	
4	0,7	63	13	4,5	3,4	4	3,70	
5	0,8	70	13	6	4,9	5	4,65	
6	1	80	16	6	4,9	5	5,55	
8	1,25	90	18	8	6,2	5	7,40	
10	1,5	100	20	10	8	5	9,30	

P2SCM...LH	CODICE - CODE		
	P2SCM...LH-T	P2CCM...LH	P2CCM...LH-T
○	○	○	○
○	○	○	○
○	○	○	○
○	○	○	○
○	○	○	○

Confezione / Box / Colis: M3 – M10: 10 pezzi / pcs M12 – M16: 5 pezzi / pcs	€ Pag. listino - Price list - Liste des prix	40	40	40	40
	● Standard	○ Disponibilità da richiedere, prezzo a listino On enquiry, standard price-list / Stock à vérifier		★ Solo a richiesta Only on request / Sur demande	

Filettatura metrica ISO passo grosso DIN 13

ISO Metric coarse thread DIN 13

Metrisches ISO-Regelgewinde DIN13 – Maschinengewindebohrer

Filetage métrique ISO DIN 13 – Tarauds machine

Rosca ISO métrica regular DIN13 – Machos de rosca a máquina

X - SERIES

MASCHI A RULLARE

Roll form taps - Tarauds à refouler

MASCHI A MACCHINA

MACHINE TAPS - TARAUDS MACHINE

DIN 371

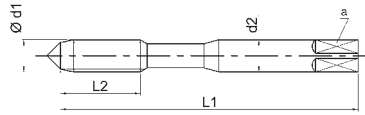

DIN 371

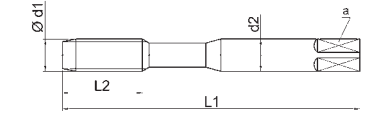

DIN 376

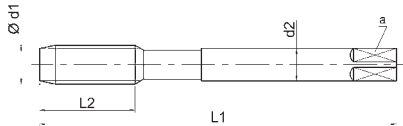

Profond. di filettatura - Thread depth - Profond. de filetage

Materiale - Material - Matériau

Tolleranza - Tolerance - Tolérance

Trattamento superficiale - Surface treatment - Revêtement

Numero gruppi materiali

Material's groups number

Nombre de groupes du matériau

TOP



TOP



TOP



TOP



3xD	3xD	3xD	3xD
PM3	PM3	PM3	PM3
6HX	6HX	6HX	6GX
CrN	TiN-G	TiCN	TiN-G
1.1 1.2	1.1 1.2 1.3 1.4 1.5	1.1 1.2 1.3 1.4 1.5	1.1 1.2 1.3 1.4 1.5
4.1 4.2 4.3	2.1 2.2 2.3 2.4	2.1 2.2 2.3 2.4	2.1 2.2 2.3 2.4
5.1 5.2	4.1 4.2 4.3	4.1 4.2 4.3	4.1 4.2 4.3
6.1	5.1 5.2 7.1 7.2	5.1 5.2 7.1 7.2	5.1 5.2 7.1 7.2

DIN 371	Ød1 M	P mm	L1	L2	d2 h9	a h12	Z	
◀	3	0,5	56	10	3,5	2,7	-	2,80
◀	4	0,7	63	13	4,5	3,4	-	3,70
◀	5	0,8	70	13	6	4,9	-	4,65
◀	6	1	80	16	6	4,9	-	5,55
◀	8	1,25	90	18	8	6,2	-	7,40
◀	10	1,5	100	20	10	8	-	9,30
	8	1,25	90	18	8	6,2	-	7,40
	10	1,5	100	20	10	8	-	9,30

CODICE - CODE			
X2SCM...NC	X2SCM...TG	X2SCM...CT	X3SCM...TG
○	●	○	○
○	●	○	○
○	●	○	○
○	●	○	○
○	●	○	○
○	●	○	○
X2SCM ...SP-NC	X2SCM ...SP-TG	X2SCM ...SP-CT	X3SCM...SP-TG
○	○	○	○
○	○	○	○

DIN 376	Ød1 M	P mm	L1	L2	d2 h9	a h12	Z	
	12	1,75	110	25	9	7	-	11,20
	14	2	110	28	11	9	-	13,10
	16	2	110	28	12	9	-	15,10

CODICE - CODE			
X2SCM...NC	X2SCM...TG	X2SCM...CT	X3SCM...TG
○	○	○	○
○	○	○	○
○	○	○	○

***** Ad esaurimento scorte
Stock clearance - Stock épuisé

Confezione / Box / Colis:
M3 – M10: 10 pezzi / pcs
M12 – M16: 5 pezzi / pcs

€ Pag. listino - Price list - Liste des prix

40

40

41

41

● Standard

○ Disponibilità da richiedere, prezzo a listino
On enquiry, standard price-list / Stock à vérifier

★ Solo a richiesta
Only on request / Sur demande

X - SERIES

MASCHI A RULLARE

Roll form taps - Tarauds à refouler

MASCHI A MACCHINA

MACHINE TAPS - TARAUDS MACHINE

DIN 371

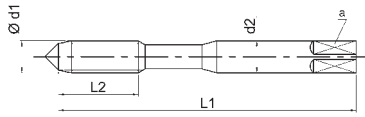

DIN 371

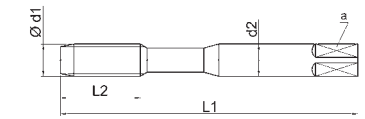

DIN 376

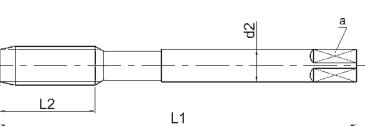

TOP



TOP



TOP



TOP



Profond. di filettatura - Thread depth - Profond. de filetage

Materiale - Material - Matériau

Tolleranza - Tolerance - Tolérance

Trattamento superficiale - Surface treatment - Revêtement

Numero gruppi materiali

Material's groups number

Nombre de groupes du matériau

3xD	3xD	3xD	3xD
PM3	PM3	PM3	PM3
6HX	6HX	6HX	6GX
CrN	TiN-G	TiCN	TiN-G
1.1 1.2	1.1 1.2 1.3 1.4 1.5	1.1 1.2 1.3 1.4 1.5	1.1 1.2 1.3 1.4 1.5
4.1 4.2 4.3	2.1 2.2 2.3 2.4	2.1 2.2 2.3 2.4	2.1 2.2 2.3 2.4
5.1 5.2	4.1 4.2 4.3	4.1 4.2 4.3	4.1 4.2 4.3
6.1	5.1 5.2 7.1 7.2	5.1 5.2 7.1 7.2	5.1 5.2 7.1 7.2

DIN 371	Ød1 M	P mm	L1	L2	d2 h9	a h12	Z	
3	0,5	56	10	3,5	2,7	2	2,80	
4	0,7	63	13	4,5	3,4	4	3,70	
5	0,8	70	13	6	4,9	5	4,65	
6	1	80	16	6	4,9	5	5,55	
8	1,25	90	18	8	6,2	5	7,40	
10	1,5	100	20	10	8	5	9,30	
8	1,25	90	18	8	6,2	5	7,40	
10	1,5	100	20	10	8	5	9,30	

CODICE - CODE			
X2CCM...NC	X2CCM...TG	X2CCM...CT	X3CCM...TG
<input type="radio"/>	<input checked="" type="radio"/>	<input type="radio"/>	<input type="radio"/>
<input type="radio"/>	<input checked="" type="radio"/>	<input type="radio"/>	<input type="radio"/>
<input type="radio"/>	<input checked="" type="radio"/>	<input type="radio"/>	<input type="radio"/>
<input type="radio"/>	<input checked="" type="radio"/>	<input type="radio"/>	<input type="radio"/>
<input type="radio"/>	<input checked="" type="radio"/>	<input type="radio"/>	<input type="radio"/>
<input type="radio"/>	<input checked="" type="radio"/>	<input type="radio"/>	<input type="radio"/>
X2CCM ...SP-NC	X2CCM ...SP-TG	X2CCM ...SP-CT	X3CCM...SP-TG
<input type="radio"/>	<input type="radio"/>	<input type="radio"/>	<input type="radio"/>
<input type="radio"/>	<input type="radio"/>	<input type="radio"/>	<input type="radio"/>

DIN 376	Ød1 M	P mm	L1	L2	d2 h9	a h12	Z	
12	1,75	110	25	9	7	5	11,20	
14	2	110	28	11	9	6	13,10	
16	2	110	28	12	9	6	15,10	

CODICE - CODE			
X2CCM...NC	X2CCM...TG	X2CCM...CT	X3CCM...TG
<input type="radio"/>	<input type="radio"/>	<input type="radio"/>	<input type="radio"/>
<input type="radio"/>	<input type="radio"/>	<input type="radio"/>	<input type="radio"/>
<input type="radio"/>	<input type="radio"/>	<input type="radio"/>	<input type="radio"/>

Ad esaurimento scorte
Stock clearance - Stock épuisé

Vedi nuova serie
See new series
Voir nouvelle série
K-ROLL pag. XXXV

Vedi nuova serie
See new series
Voir nouvelle série
K-ROLL pag. XXXV

Confezione / Box / Colis: M3 – M10: 10 pezzi / pcs M12 – M16: 5 pezzi / pcs	€ Pag. listino - Price list - Liste des prix ● Standard	41	41	41	41
	○ Disponibilità da richiedere, prezzo a listino On enquiry, standard price-list / Stock à vérifier			★ Solo a richiesta Only on request / Sur demande	

Filettatura metrica ISO passo grosso DIN 13**ISO Metric coarse thread DIN 13**

Metrisches ISO-Regelgewinde DIN13 – Maschinengewindebohrer

Filetage métrique ISO DIN 13 – Tarauds machine

Rosca ISO métrica regular DIN13 – Machos de roscar a máquina

X - SERIES**MASCHI A RULLARE**

Roll form taps - Tarauds à refolder

MASCHI A MACCHINA

MACHINE TAPS - TARAUDS MACHINE

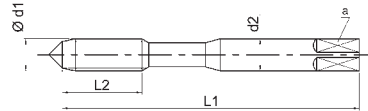
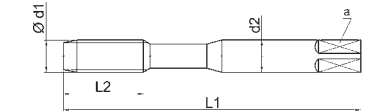
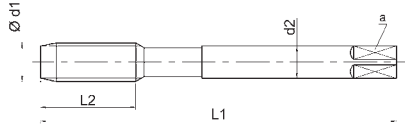
DIN 371**DIN 371****DIN 376**

Profond. di filettatura - Thread depth - Profond. de filetage

Materiale - Material - Matériau

Tolleranza - Tolerance - Tolérance

Trattamento superficiale - Surface treatment - Revêtement

Numero gruppi materiali

Material's groups number

Nombre de groupes du matériau

TOP



TOP



TOP

**3xD****3xD****3xD****PM3****PM3****PM3****6HX****6HX****6HX****TXC****TiN-G****TiN-G**

1.1 1.2

1.1 1.2 1.3 1.4 1.5

1.1 1.2 1.3 1.4 1.5

4.1 4.2 4.3

2.1 2.2 2.3 2.4

2.1 2.2 2.3 2.4

5.1 5.2

4.1 4.2 4.3

4.1 4.2 4.3

5.1 5.2 7.1 7.2

5.1 5.2 7.1 7.2

DIN 371	Ød1 M	P mm	L1	L2	d2 h9	a h12	Z	
◀	3	0,5	56	10	3,5	2,7	2	2,80
◀	4	0,7	63	13	4,5	3,4	4	3,70
◀	5	0,8	70	13	6	4,9	5	4,65
◀	6	1	80	16	6	4,9	5	5,55
◀	8	1,25	90	18	8	6,2	5	7,40
◀	10	1,5	100	20	10	8	5	9,30
	6	1	80	16	6	4,9	5	5,55
	8	1,25	90	18	8	6,2	5	7,40
	10	1,5	100	20	10	8	5	9,30
◀	6	1	80	16	6	4,9	2	5,55
◀	8	1,25	90	18	8	6,2	2	7,40
◀	10	1,5	100	20	10	8	2	9,30

DIN 376	Ød1 M	P mm	L1	L2	d2 h9	a h12	Z	
	12	1,75	110	25	9	7	5	11,20
	14	2	110	28	11	9	6	13,10
	16	2	110	28	12	9	6	15,10
	12	1,75	110	25	9	7	3	11,20
	14	2	110	28	11	9	3	13,10
	16	2	110	28	12	9	3	15,10

CODICE - CODE

X2CCM...TXC

○

○

○

○

○

○

X2CCM...FOR-TG

-

-

-

X2CCM...FORY-TG

-

-

-

○ 4L/Z2

○ 4L/Z2

○ 4L/Z2

CODICE - CODE

X2CCM...TXC

X2CCM...FOR-TG

○

○

○

X2CCM...FORY-TG

-

-

-

○ 6L/Z3

○ 6L/Z3

○ 6L/Z3

N° lobi
Lobes' Number / N° de LobesN° canalini / Oil grooves' Number
N° de rainures de lubrificationsAd esaurimento scorte
Stock clearance - Stock épuiséConfezione / Box / Colis:
M3 – M10: 10 pezzi / pcs
M12 – M16: 5 pezzi / pcs

€ Pag. listino - Price list - Liste des prix

42**42****42**

● Standard

○ Disponibilità da richiedere, prezzo a listino
On enquiry, standard price-list / Stock à vérifier★ Solo a richiesta
Only on request / Sur demande

X - SERIES

MASCHI A RULLARE

Roll form taps - Tarauds à refouler

MASCHI A MACCHINA

MACHINE TAPS - TARAUDS MACHINE

DIN 371

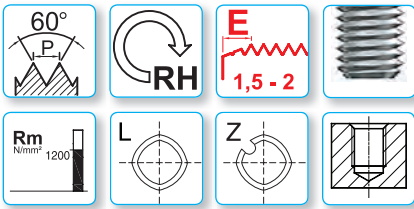
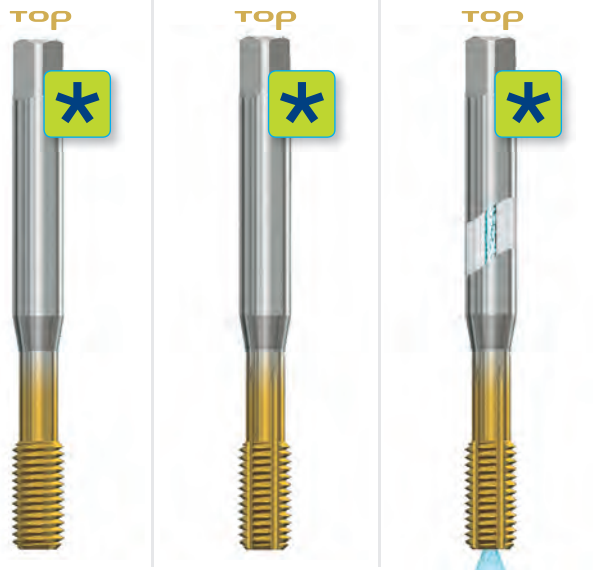
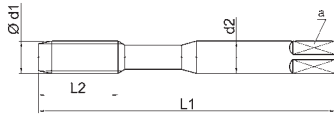

Profond. di filettatura - Thread depth - Profond. de filetage

Materiale - Material - Matériau

Tolleranza - Tolerance - Tolérance

Trattamento superficiale - Surface treatment - Revêtement

Numero gruppi materiali

Material's groups number

Nombre de groupes du matériau

3xD	3xD	3xD
PM3	PM3	PM3
6HX	6HX	6HX
TiN-G	TiN-G	TiN-G
1.1 1.2 1.3 1.4 1.5	1.1 1.2 1.3 1.4 1.5	1.1 1.2 1.3 1.4 1.5
2.1 2.2 2.3 2.4	2.1 2.2 2.3 2.4	2.1 2.2 2.3 2.4
4.1 4.2 4.3	4.1 4.2 4.3	4.1 4.2 4.3
5.1 5.2 7.1 7.2	5.1 5.2 7.1 7.2	5.1 5.2 7.1 7.2

DIN 371	Ød1 M	P mm	L1	L2	d2 h9	a h12	Z	
6	1	80	16	6	4,9	5	5,55	
8	1,25	90	18	8	6,2	5	7,40	
10	1,5	100	20	10	8	5	9,30	

X2SCEM...TG	CODICE - CODE	
	X2CCEM...TG	X2CCEM...FOR-TG
○	○	○
○	○	○
○	○	○

***** Ad esaurimento scorte
Stock clearance - Stock épuisé

Vedi nuova serie
See new series - Voir nouvelle série
K-ROLL pag. XXXVI

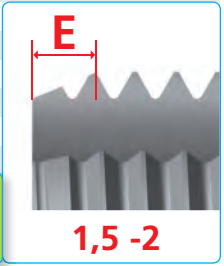

M Filettatura metrica ISO passo grosso DIN 13

ISO Metric coarse thread DIN 13

Metrisches ISO-Regelgewinde DIN13 – Maschinengewindebohrer

Filetage métrique ISO DIN 13 – Tarauds machine

Rosca ISO métrica regular DIN13 – Machos de rosca a máquina

MDI-HM

METALLO DURO INTEGRALE - MASCHI A RULLARE

Integral hard metal, roll form taps - Carbure, tarauds à refouler

MASCHI A MACCHINA

MACHINE TAPS - TARAUDS MACHINE

DIN 371

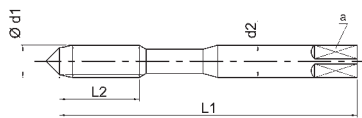

DIN 371

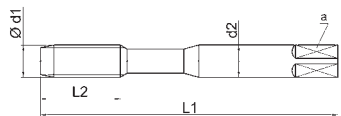

Profond. di filettatura - Thread depth - Profond. de filetage

Materiale - Material - Matériau

Tolleranza - Tolerance - Tolérance

Trattamento superficiale - Surface treatment - Revêtement

Numero gruppi materiali

Material's groups number

Nombre de groupes du matériau

TOP



3xD

MDI/HM

6HX

TiN

1.1 1.2 1.3 1.4 1.5

2.1 2.2 2.3 2.4

4.1 4.2 4.3

5.1 5.2 7.1 7.2

TOP



3xD

MDI/HM

6HX

TiCN

1.1 1.2 1.3 1.4 1.5

2.1 2.2 2.3 2.4

4.1 4.2 4.3

5.1 5.2 7.1 7.2

DIN 371	Ød1 M	P mm	L ₁	L ₂	d ₂ h6	a h12	Z	
5	0,8	70	8,5	6	4,9	-	4,65	
6	1	80	11	6	4,9	-	5,55	
8	1,25	90	14	8	6,2	-	7,40	
10	1,5	100	10	10	8	-	9,30	

CODICE - CODE	
HM2SCM...FOR-T	HM2CCM...FOR-CT
*	*
*	*
*	*
*	*

Confezione / Box / Colis:
M3 – M10: 10 pezzi / pcs
M12 – M16: 5 pezzi / pcs

€ Pag. listino - Price list - Liste des prix

42

42

• Standard

○ Disponibilità da richiedere, prezzo a listino
On enquiry, standard price-list / Stock à vérifier

★ Solo a richiesta
Only on request / Sur demande

UNI 5870 - ISO 1502

Calibri a tampone filettati passa / non passa

Thread plug gauges go/no-go

Calibres de filetage entre/n'entre pas



Tolleranza - Tolerance - Tolérance

6H

Trattamento superficiale - Surface treatment - Revêtement

BR

Ød1 M	P mm	CODICE - CODE P-NPM...
2	0,4	○
2,2	0,45	○
2,5	0,45	○
3	0,5	○
3,5	0,6	○
4	0,7	○
4,5	0,75	○
5	0,8	○
6	1	○
7	1	○
8	1,25	○
9	1,25	○
10	1,5	○
11	1,5	○
12	1,75	○
14	2	○
16	2	○
18	2,5	○
20	2,5	○
22	2,5	○
24	3	○
27	3	○
30	3,5	○
33	3,5	○
36	4	○
39	4	○
42	4,5	○
45	4,5	○
48	5	○

Confezione: Singola
Box: Single
Colis: Unique

€ Pag. listino - Price list - Liste des prix

108

● Standard

○ Disponibilità da richiedere, prezzo a listino
On enquiry, standard price-list / Stock à vérifier

★ Solo a richiesta
Only on request / Sur demande



MF

MF



MF

Filettatura metrica ISO passo fine DIN 13

ISO metric fine thread DIN13

Metrisches ISO-Feingewinde DIN 13 – Handgewindebohrer

Filetage métrique ISO à pas fin DIN 13 – Tarauds à main

Rosca ISO métrica fina DIN 13 – Machos de rosca a mano



N

USO GENERALE

General purpose - Usage Général

MASCHI A MANO

HAND TAPS - TARAUDS MAIN

DIN 2181

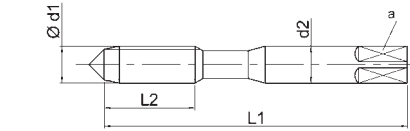

DIN 2181

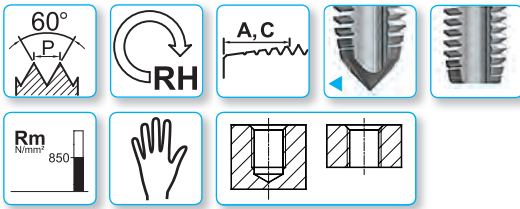
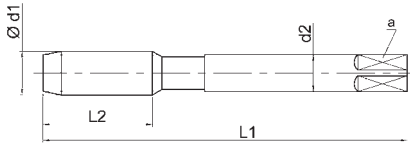

LINE



A
5-6

LINE



C
2-3

LINE



Profond. di filettatura - Thread depth - Profond. de filetage

Materiale - Material - Matériau

Tolleranza - Tolerance - Tolérance

Trattamento superficiale - Surface treatment - Revêtement

Numero gruppi materiali

Material's groups number

Nombre de groupes du matériau

2xD

2xD

2xD

HSS

HSS

HSS

-

ISO2/6H

ISO2/6H

BR

BR

BR

1.1 1.2 1.3 1.4

1.1 1.2 1.3 1.4

1.1 1.2 1.3 1.4

2.1 2.2 2.3 3.1 3.4

2.1 2.2 2.3 3.1 3.4

2.1 2.2 2.3 3.1 3.4

4.1 4.2 4.3 4.4

4.1 4.2 4.3 4.4

4.1 4.2 4.3 4.4

5.1 5.2 5.3

5.1 5.2 5.3

5.1 5.2 5.3

DIN 2181	Ød1 MF	P mm	L1	L2	d2 h9	a h12	Z	
4	0,5	45	11	4,5	3,4	3	3,5	
4,5	0,5	50	13	6	4,9	3	4	
5	0,5	50	13	6	4,9	3	4,5	
6	0,75	56	15	6	4,9	3	5,25	
7	0,75	56	16	6	4,9	3	6,25	
8	0,75	63	19	6	4,9	3	7,25	
8	1	63	19	6	4,9	3	7	
9	1	63	19	7	5,5	3	8	
10	0,75	63	20	7	5,5	3	9,25	
10	1	63	20	7	5,5	3	9	
10	1,25	70	22	7	5,5	3	8,75	
11	1	63	20	8	6,2	3	10	
12	1	70	22	9	7	4	11	
12	1,25	70	22	9	7	4	10,75	
12	1,5	70	22	9	7	4	10,5	
14	1	70	22	11	9	4	13	
14	1,25	70	22	11	9	4	12,75	
14	1,5	70	22	11	9	4	12,5	
15	1	70	22	12	9	4	14	
15	1,5	70	22	12	9	4	13,5	
16	1	70	22	12	9	4	15	
16	1,25	70	22	12	9	4	14,75	
16	1,5	70	22	12	9	4	14,5	
18	1	80	22	14	11	4	17	
18	1,5	80	22	14	11	4	16,5	
18	2	80	22	14	11	4	16	

CODICE - CODE		01MF...	03MF...	00MF...
		<input type="radio"/>	<input type="radio"/>	<input type="radio"/>
		<input type="radio"/>	<input type="radio"/>	<input type="radio"/>
		<input type="radio"/>	<input type="radio"/>	<input type="radio"/>
		<input type="radio"/>	<input type="radio"/>	<input checked="" type="radio"/>
		<input type="radio"/>	<input type="radio"/>	<input type="radio"/>
		<input type="radio"/>	<input type="radio"/>	<input type="radio"/>
		<input type="radio"/>	<input type="radio"/>	<input checked="" type="radio"/>
		<input type="radio"/>	<input type="radio"/>	<input type="radio"/>
		<input type="radio"/>	<input type="radio"/>	<input type="radio"/>
		<input type="radio"/>	<input type="radio"/>	<input checked="" type="radio"/>
		<input type="radio"/>	<input type="radio"/>	<input type="radio"/>
		<input type="radio"/>	<input type="radio"/>	<input type="radio"/>
		<input type="radio"/>	<input type="radio"/>	<input checked="" type="radio"/>
		<input type="radio"/>	<input type="radio"/>	<input type="radio"/>
		<input type="radio"/>	<input type="radio"/>	<input type="radio"/>
		<input type="radio"/>	<input type="radio"/>	<input checked="" type="radio"/>
		<input type="radio"/>	<input type="radio"/>	<input type="radio"/>
		<input type="radio"/>	<input type="radio"/>	<input type="radio"/>
		<input type="radio"/>	<input type="radio"/>	<input checked="" type="radio"/>
		<input type="radio"/>	<input type="radio"/>	<input type="radio"/>
		<input type="radio"/>	<input type="radio"/>	<input type="radio"/>
		<input type="radio"/>	<input type="radio"/>	<input checked="" type="radio"/>
		<input type="radio"/>	<input type="radio"/>	<input type="radio"/>
		<input type="radio"/>	<input type="radio"/>	<input type="radio"/>
		<input type="radio"/>	<input type="radio"/>	<input checked="" type="radio"/>
		<input type="radio"/>	<input type="radio"/>	<input type="radio"/>
		<input type="radio"/>	<input type="radio"/>	<input type="radio"/>
		<input type="radio"/>	<input type="radio"/>	<input checked="" type="radio"/>
		<input type="radio"/>	<input type="radio"/>	<input type="radio"/>

Ad esaurimento scorte
Stock clearance - Stock épuisé

Segue diametri
Diameters, to be continued
Diamètres à suivre

Pag. 83-84

Confezione: Singola Box: Single Colis: Unique	€ Pag. listino - Price list - Liste des prix	43	43	43
● Standard	○ Disponibilità da richiedere, prezzo a listino On enquiry, standard price-list / Stock à vérifier			★ Solo a richiesta Only on request / Sur demande

N **USO GENERALE**
General purpose - Usage Général

MASCHI A MANO
HAND TAPS - TARAUDS MAIN

DIN
2181

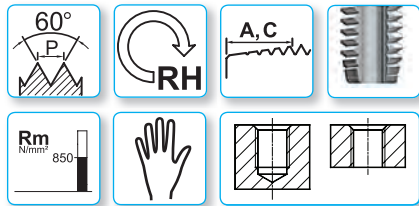
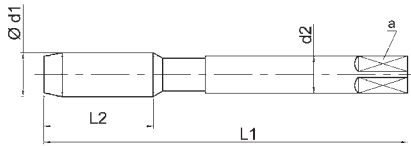

LINE

LINE

LINE



A
5-6



C
2-3



Profond. di filettatura - Thread depth - Profond. de filetage

Materiale - Material - Matériau

Tolleranza - Tolerance - Tolérance

Trattamento superficiale - Surface treatment - Revêtement

Numero gruppi materiali
Material's groups number
Nombre de groupes du matériau

2xD	2xD	2xD
HSS	HSS	HSS
-	ISO2/6H	ISO2/6H
BR	BR	BR
1.1 1.2 1.3 1.4	1.1 1.2 1.3 1.4	1.1 1.2 1.3 1.4
2.1 2.2 2.3 3.1 3.4	2.1 2.2 2.3 3.1 3.4	2.1 2.2 2.3 3.1 3.4
4.1 4.2 4.3 4.4	4.1 4.2 4.3 4.4	4.1 4.2 4.3 4.4
5.1 5.2 5.3	5.1 5.2 5.3	5.1 5.2 5.3

DIN 2181	Ød1 MF	P mm	L ₁	L ₂	d ₂ h9	a h12	Z	
	20	1	80	22	16	12	4	19
	20	1,5	80	22	16	12	4	18,5
	20	2	80	22	16	12	4	18
	22	1	80	22	18	14,5	4	21
	22	1,5	80	22	18	14,5	4	20,5
	22	2	80	22	18	14,5	4	20
	24	1	90	22	18	14,5	4	23
	24	1,5	90	22	18	14,5	4	22,5
	24	2	90	22	18	14,5	4	22
	25	1,5	90	22	18	14,5	4	23,5
	25	2	90	22	18	14,5	4	23
	26	1,5	90	22	18	14,5	4	24,5
	26	2	90	22	18	14,5	4	24
	27	1,5	90	22	20	16	4	25,5
	27	2	90	22	20	16	4	25
	28	1,5	90	22	20	16	4	26,5
	28	2	90	22	20	16	4	26
	30	1,5	90	22	22	18	4	28,5
	30	2	90	22	22	18	4	28
	32	1,5	90	22	22	18	5	30,5
	32	2	90	22	22	18	5	30
	33	2	100	25	25	20	5	31
	35	1,5	100	25	28	22	5	33,5
	35	2	125	30	28	22	5	33
	36	1,5	100	25	28	22	5	34,5
	36	2	125	36	28	22	4	34
	36	3	125	36	28	22	4	33

Ad esaurimento scorte
Stock clearance - Stock épuisé

CODICE - CODE		
01MF...	03MF...	00MF...
<input type="radio"/>	<input type="radio"/>	<input type="radio"/>
<input type="radio"/>	<input type="radio"/>	<input checked="" type="radio"/>
<input type="radio"/>	<input type="radio"/>	<input type="radio"/>
<input type="radio"/>	<input type="radio"/>	<input type="radio"/>
<input type="radio"/>	<input type="radio"/>	<input checked="" type="radio"/>
<input type="radio"/>	<input type="radio"/>	<input type="radio"/>
<input type="radio"/>	<input type="radio"/>	<input type="radio"/>
<input type="radio"/>	<input type="radio"/>	<input type="radio"/>
<input type="radio"/>	<input type="radio"/>	<input type="radio"/>
<input type="radio"/>	<input type="radio"/>	<input type="radio"/>
<input type="radio"/>	<input type="radio"/>	<input type="radio"/>
<input type="radio"/>	<input type="radio"/>	<input type="radio"/>
<input type="radio"/>	<input type="radio"/>	<input type="radio"/>
<input type="radio"/>	<input type="radio"/>	<input type="radio"/>
<input type="radio"/>	<input type="radio"/>	<input type="radio"/>
<input type="radio"/>	<input type="radio"/>	<input type="radio"/>
<input type="radio"/>	<input type="radio"/>	<input type="radio"/>
<input type="radio"/>	<input type="radio"/>	<input type="radio"/>
<input type="radio"/>	<input type="radio"/>	<input type="radio"/>
<input type="radio"/>	<input type="radio"/>	<input type="radio"/>
<input type="radio"/>	<input type="radio"/>	<input type="radio"/>
<input type="radio"/>	<input type="radio"/>	<input type="radio"/>

Segue diametri
Diameters, to be continued, Diamètres à suivre ▶ Pag. 84

MASCHI A MANO

HAND TAPS - TARAUDS MAIN

DIN 2181

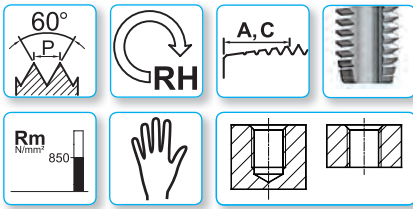
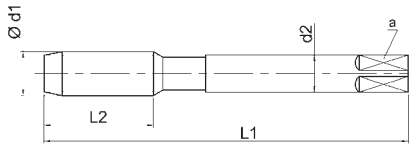

LINE

LINE

LINE



A 5-6

C 2-3

Profond. di filettatura - Thread depth - Profond. de filetage

Materiale - Material - Matériau

Tolleranza - Tolerance - Tolérance

Trattamento superficiale - Surface treatment - Revêtement

Numero gruppi materiali

Material's groups number

Nombre de groupes du matériau

2xD

2xD

2xD

HSS

HSS

HSS

-

ISO2/6H

ISO2/6H

BR

BR

BR

1.1 1.2 1.3 1.4

1.1 1.2 1.3 1.4

1.1 1.2 1.3 1.4

2.1 2.2 2.3 3.1 3.4

2.1 2.2 2.3 3.1 3.4

2.1 2.2 2.3 3.1 3.4

4.1 4.2 4.3 4.4

4.1 4.2 4.3 4.4

4.1 4.2 4.3 4.4

5.1 5.2 5.3

5.1 5.2 5.3

5.1 5.2 5.3

DIN 2181	Ød1 MF	P mm	L1	L2	d2 h9	a h12	Z	
	38	1,5	100	25	28	22	6	36,5
	39	1,5	110	25	32	24	6	37,5
	39	2	125	36	32	24	4	37
	39	3	125	36	32	24	4	36
	40	1,5	110	25	32	24	6	38,5
	40	2	125	36	32	24	5	38
	40	3	125	36	32	24	5	37
	42	1,5	110	25	32	24	6	40,5
	42	2	125	36	32	24	5	40
	42	3	125	36	32	24	5	39
	45	1,5	110	25	36	29	6	43,5
	45	2	125	36	36	29	5	43
	45	3	125	36	36	29	5	42
	48	1,5	140	36	36	29	6	46,5
	48	2	140	36	36	29	6	46
	48	3	140	36	36	29	6	45
	50	1,5	140	36	36	29	6	48,5
	50	2	140	36	36	29	6	48
	50	3	140	36	36	29	6	47
	52	1,5	140	36	40	32	6	50,5
	52	2	140	36	40	32	6	50
	52	3	140	36	40	32	6	49

CODICE - CODE

01MF...

03MF...

00MF...

*

o

o

*

o

o

*

o

o

*

o

o

*

o

o

*

o

o

*

o

o

*

o

o

*

o

o

*

o

o

*

o

o

*

o

o

*

o

o

*

o

o

*

o

o

*

o

o

*

o

o

*

o

o

*

o

o

*

o

o



Ad esaurimento scorte
Stock clearance - Stock épuisé

Confezione: Singola
Box: Single
Colis: Unique

€ Pag. listino - Price list - Liste des prix

44

44

44

• Standard

o Disponibilità da richiedere, prezzo a listino
On enquiry, standard price-list / Stock à vérifier

* Solo a richiesta
Only on request / Sur demande

N **USO GENERALE**
General purpose - Usage Général

MASCHI A MANO, FILETTATURA SINISTRA
LEFT HAND TAPS - TARAUDS MAIN GAUCHE

DIN 2181

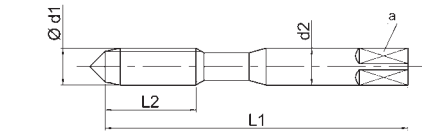

DIN 2181

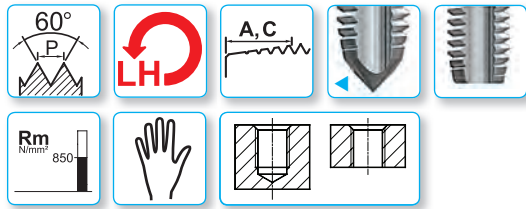
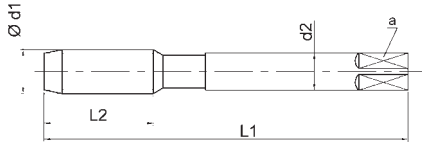

LINE

LINE

LINE



A
5-6



C
2-3



Profond. di filettatura - Thread depth - Profond. de filetage
Materiale - Material - Matériau
Tolleranza - Tolerance - Tolérance
Trattamento superficiale - Surface treatment - Revêtement

Numero gruppi materiali
Material's groups number
Nombre de groupes du matériau

1.1	1.2	1.3	1.4	1.1	1.2	1.3	1.4	1.1	1.2	1.3	1.4			
2.1	2.2	2.3	3.1	3.4	2.1	2.2	2.3	3.1	3.4	2.1	2.2	2.3	3.1	3.4
4.1	4.2	4.3	4.4	4.1	4.2	4.3	4.4	4.1	4.2	4.3	4.4			
5.1	5.2	5.3	5.1	5.2	5.3	5.1	5.2	5.3						

2xD	2xD	2xD
HSS	HSS	HSS
-	ISO2/6H	ISO2/6H
BR	BR	BR

DIN 2181	Ød1 MF	P mm	L ₁	L ₂	d ₂ h9	a h12	Z	Icon
◀	4	0,5	45	11	4,5	3,4	3	3,5
◀	5	0,5	50	13	6	4,9	3	4,5
◀	6	0,75	56	15	6	4,9	3	5,25
	8	1	63	19	6	4,9	3	7
	10	1,25	70	22	7	5,5	3	8,75
	10	1	63	20	7	5,5	3	9
	11	1	63	20	8	6,2	3	10
	12	1,5	70	22	9	7	4	10,5
	12	1,25	70	22	9	7	4	10,75
	12	1	70	22	9	7	4	11
	14	1,5	70	22	11	9	4	12,5
	16	1,5	70	22	12	9	4	14,5
	18	1,5	80	22	14	11	4	16,5
	20	1,5	80	22	16	12	4	18,5

CODICE - CODE	01MF...LH		03MF...LH		00MF...LH	
	○	●	○	●	○	●
○			○		○	
○			○		○	
○			○		○	
○			○		○	
○			○		○	
○			○		○	
○			○		○	
○			○		○	
○			○		○	
○			○		○	
○			○		○	
○			○		○	
○			○		○	
○			○		○	
○			○		○	
○			○		○	
○			○		○	
○			○		○	
○			○		○	
○			○		○	
○			○		○	
○			○		○	

***** Ad esaurimento scorte
Stock clearance - Stock épuisé

MF Filettatura metrica ISO passo fine DIN 13

ISO metric fine thread DIN13
 Metrisches ISO-Feingewinde DIN 13 – Maschinengewindebohrer
 Filetage métrique ISO à pas fin DIN 13 – Tarauds machine
 Rosca ISO métrica fina DIN 13 – Machos de rosca a máquina



N

USO GENERALE
 General purpose - Usage Général

MASCHI A MACCHINA

MACHINE TAPS - TARAUDS MACHINE

DIN 371

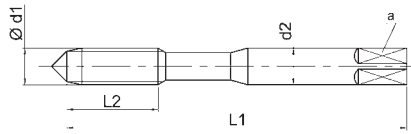

DIN 371

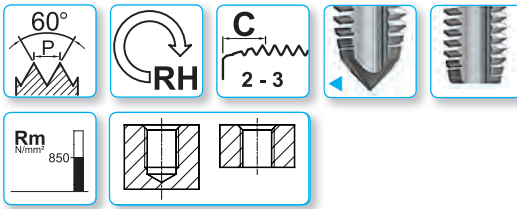
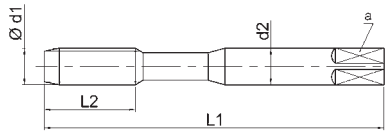

LINE



LINE



Profond. di filettatura - Thread depth - Profond. de filetage

Materiale - Material - Matériau

Tolleranza - Tolerance - Tolérance

Trattamento superficiale - Surface treatment - Revêtement

1,5xD

HSSE

ISO2/6H

BR

1.1 1.2 1.3 1.4 3.4

4.2 4.3 5.2 5.3

8.2

1,5xD

HSSE

ISO2/6H

TiN

1.1 1.2 1.3 1.4 3.4

4.2 4.3 5.2 5.3

8.2

Numero gruppi materiali
 Material's groups number
 Nombre de groupes du matériau

DIN 371	Ød1 MF	P mm	L ₁	L ₂	d ₂ h9	a h12	Z	
◀	4	0,5	63	13	4,5	3,4	3	3,5
◀	5	0,5	70	13	6	4,9	3	4,5
◀	6	0,5	80	16	6	4,9	3	5,5
◀	6	0,75	80	16	6	4,9	3	5,25
◀	7	0,75	80	16	7	5,5	3	6,25
◀	8	0,5	90	18	8	6,2	3	7,5
◀	8	0,75	90	18	8	6,2	3	7,25
◀	8	1	90	18	8	6,2	3	7
	9	0,5	90	18	9	7	3	8,5
	9	0,75	90	18	9	7	3	8,25
	9	1	90	18	9	7	3	8
◀	10	0,5	90	15	10	8	3	9,5
◀	10	0,75	90	15	10	8	3	9,25
◀	10	1	90	15	10	8	3	9
◀	10	1,25	100	20	10	8	3	8,75

CODICE - CODE	
E20MF...	E20MF...T
○	○
○	○
○	○
●	○
○	○
○	○
○	○
●	○
★	★
★	★
○	○
○	○
○	○
○	○
●	○
●	○

Segue diametri
 Diameters, to be continued

▶ Pag. 87...92

Confezione: Singola
 Box: Single
 Colis: Unique

€ Pag. listino - Price list - Liste des prix

45

45

● Standard

○ Disponibilità da richiedere, prezzo a listino
 On enquiry, standard price-list / Stock à vérifier

★ Solo a richiesta
 Only on request / Sur demande

N
USO GENERALE

General purpose - Usage Général

MASCHI A MACCHINA

MACHINE TAPS - TARAUDS MACHINE

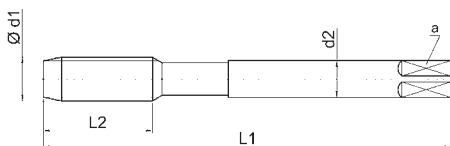
DIN 374

LINE

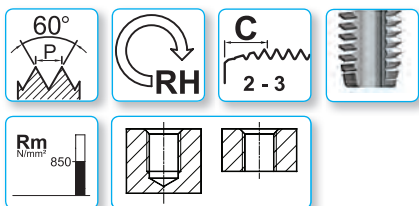
Profond. di filettatura - Thread depth - *Profond. de filetage*
1,5xD
Materiale - Material - *Matériau*
HSSE
Tolleranza - Tolerance - *Tolérance*
ISO2/6H
Trattamento superficiale - Surface treatment - *Revêtement*
BR
Numero gruppi materiali

Material's groups number

Nombre de groupes du matériau

 1.1 1.2 1.3 1.4 3.4

 4.2 4.3 5.2 5.3

 8.2

DIN 374	Ød1 MF	P mm	L ₁	L ₂	d ₂ h9	a h12	Z	
	25	1	140	25	18	14,5	4	24
	25	1,5	140	25	18	14,5	4	23,5
	25	2	140	25	18	14,5	4	23
	26	1	140	25	18	14,5	4	25
	26	1,5	140	25	18	14,5	4	24,5
	26	2	140	25	18	14,5	4	24
	27	1	140	25	20	16	4	26
	27	1,5	140	25	20	16	4	25,5
	27	2	140	25	20	16	4	25
	28	1	140	25	20	16	4	27
	28	1,5	140	25	20	16	4	26,5
	28	2	140	25	20	16	4	26
	30	1	150	28	22	18	4	29
	30	1,5	150	28	22	18	4	28,5
	30	2	150	28	22	18	4	28
	30	3	180	46	22	18	4	27
	32	1,5	150	28	22	18	5	30,5
	32	2	150	28	22	18	5	30
	33	1,5	160	30	25	20	5	31,5
	33	2	160	30	25	20	5	31
	33	3	180	46	25	20	4	30
	34	1	170	30	28	22	5	33
	34	1,5	170	30	28	22	5	32,5
	34	2	170	30	28	22	5	32
	35	1,5	170	30	28	22	5	33,5
	35	2	170	30	28	22	5	33
	35	3	200	50	28	22	4	32

CODICE - CODE

E21MF

 Segue diametri
 Diameters, to be continued
 Diamètres à suivre

Pag. 90...92

 Confezione: Singola
 Box: Single
 Colis: Unique

€ Pagina listino - Price list page
45
 Standard

 Disponibilità da richiedere, prezzo a listino
 On enquiry, standard price-list / Stock à vérifier

 Solo a richiesta
 Only on request / Sur demande

MASCHI A MACCHINA

MACHINE TAPS - TARAUDS MACHINE

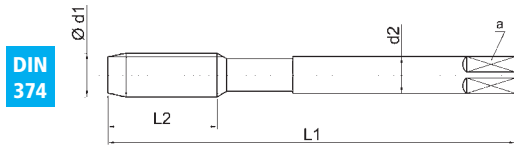

DIN 374

LINE

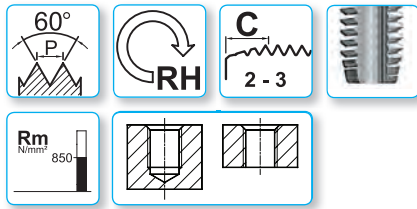

Profond. di filettatura - Thread depth - Profond. de filetage

1,5xD

Materiale - Material - Matériau

HSSE

Tolleranza - Tolerance - Tolérance

ISO2/6H

Trattamento superficiale - Surface treatment - Revêtement

BR

Numero gruppi materiali

Material's groups number

Nombre de groupes du matériau

1.1 1.2 1.3 1.4 3.4

4.2 4.3 5.2 5.3

8.2

DIN 374	Ød1 MF	P mm	L ₁	L ₂	d ₂ h9	a h12	Z	
	36	1	170	30	28	22	5	35
	36	1,25	170	30	28	22	5	34,75
	36	1,5	170	30	28	22	5	34,5
	36	2	170	30	28	22	5	34
	36	3	200	50	28	22	4	33
	37	1	170	30	28	22	6	36
	37	1,5	170	30	28	22	6	35,5
	38	1	170	30	28	22	6	37
	38	1,5	170	30	28	22	6	36,5
	38	2	170	30	28	22	6	36
	38	3	200	50	28	22	4	35
	39	1	170	30	32	24	6	38
	39	1,5	170	30	32	24	6	37,5
	39	2	170	30	32	24	6	37
	39	3	200	50	32	24	4	36
	40	1	170	30	32	24	6	39
	40	1,5	170	30	32	24	6	38,5
	40	2	170	30	32	24	6	38
	40	3	200	50	32	24	5	37
	42	1	170	30	32	24	6	41
	42	1,5	170	30	32	24	6	40,5
	42	2	170	30	32	24	6	40
	42	3	200	55	32	24	5	39
■	45	1	180	32	36	29	6	44
■	45	1,5	180	32	36	29	6	43,5
■	45	2	180	32	36	29	6	43
■	45	3	200	50	36	29	5	42

■ = Acciaio HSS / HSS Steel / Acier HSS

CODICE - CODE

E21MF...

○

○

○

○

○

○

○

○

○

○

○

○

○

○

○

○

○

○

○

○

○

○

○

○

○

Segue diametri
Diameters, to be continued
Diamètres à suivre

Pag. 91...92

Confezione: Singola
Box: Single
Colis: Unique

€ Pag. listino - Price list - Liste des prix

45

● Standard

○ Disponibilità da richiedere, prezzo a listino
On enquiry, standard price-list / Stock à vérifier

★ Solo a richiesta
Only on request / Sur demande

N **USO GENERALE**
General purpose - Usage Général

MASCHI A MACCHINA
MACHINE TAPS - TARAUDS MACHINE

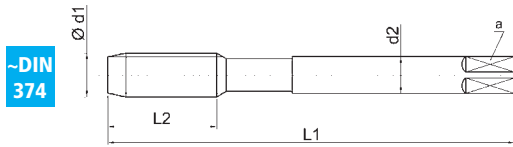

LINE

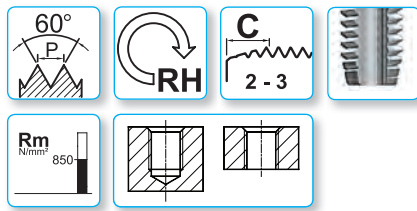

Profond. di filettatura - Thread depth - Profond. de filetage

1,5xD

Materiale - Material - Matériau

HSSE

Tolleranza - Tolerance - Tolérance

ISO2/6H

Trattamento superficiale - Surface treatment - Revêtement

BR

Numero gruppi materiali

Material's groups number

Nombre de groupes du matériau

1.1 1.2 1.3 1.4 3.4

4.2 4.3 5.2 5.3

8.2

-DIN 374	$\varnothing d1$ MF	P mm	L ₁	L ₂	d ₂ h9	a h12	Z	
■	48	1	190	32	36	29	6	47
■	48	1,5	190	32	36	29	6	46,5
■	48	2	190	32	36	29	6	46
■	*48	3	220	65	36	29	6	45
■	49	1,5	190	32	36	29	6	47,5
■	49	3	220	65	36	29	6	46
■	50	1	190	32	36	29	6	49
■	50	1,5	190	32	36	29	6	48,5
■	50	2	190	32	36	29	6	48
■	*50	3	220	65	36	29	6	47
■	52	1,5	190	32	40	32	6	50,5
■	52	2	190	32	40	32	6	50
■	*52	3	220	65	40	32	6	49
■	*54	1,5	190	32	40	32	6	52,5
■	*54	2	190	32	40	32	6	52
■	*55	1,5	190	32	40	32	6	53,5
■	*55	2	190	32	40	32	6	53
■	*55	3	220	65	40	32	6	52
■	*56	1,5	190	32	40	32	6	54,5
■	*56	2	190	32	40	32	6	54
■	*56	3	220	65	40	32	6	53
■	*56	4	220	65	40	32	6	52
■	*58	1,5	190	32	40	32	6	56,5
■	*58	2	190	32	40	32	6	56
■	*58	3	220	65	40	32	6	55

■ = Acciaio HSS / HSS Steel / Acier HSS

* Dimensioni a norma UFS / Dimensions according UFS' norms / Dimensions selon norme UFS

CODICE - CODE

E21MF...

○

○

○

○

○

○

○

○

○

○

○

○

○

○

○

○

○

○

○

○

○

○

○

Segue diametri
Diameters, to be continued
Diamètres à suivre

▶ Pag. 92

Confezione: Singola
Box: Single
Colis: Unique

€ Pag. listino - Price list - Liste des prix

45-46

● Standard

○ Disponibilità da richiedere, prezzo a listino
On enquiry, standard price-list / Stock à vérifier

★ Solo a richiesta
Only on request / Sur demande

MASCHI A MACCHINA

MACHINE TAPS - TARAUDS MACHINE

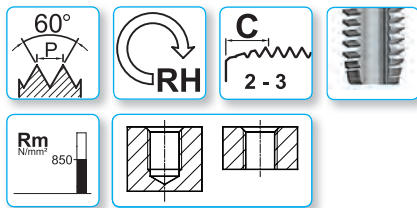
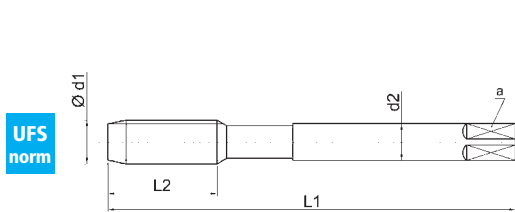

LINE



Profond. di filettatura - Thread depth - Profond. de filetage

1,5xD

Materiale - Material - Matériau

HSSE

Tolleranza - Tolerance - Tolérance

ISO2/6H

Trattamento superficiale - Surface treatment - Revêtement

BR

Numero gruppi materiali

Material's groups number

Nombre de groupes du matériau

1.1 1.2 1.3 1.4 3.4

4.2 4.3 5.2 5.3

8.2

UFS norm	Ød1 MF	P mm	L ₁	L ₂	d ₂ h9	a h12	Z	
■	*60	1,5	190	32	45	35	6	58,5
■	*60	2	190	32	45	35	6	58
■	*60	3	220	65	45	35	6	57
■	*60	4	220	65	45	35	6	56
■	*62	1,5	190	32	50	39	6	60,5
■	*62	2	190	32	50	39	6	60
■	*63	1,5	190	32	50	39	6	61,5
■	*64	1,5	190	32	50	39	6	62,5
■	*64	2	190	32	50	39	6	62
■	*64	3	220	65	50	39	6	61
■	*64	4	220	65	50	39	6	60

CODICE - CODE

E21MF...

○

○

○

○

○

○

○

○

○

○

■ = Acciaio HSS / HSS Steel / Acier HSS

* Dimensioni a norma UFS / Dimensions according UFS' norms / Dimensions selon norme UFS

Confezione: Singola
Box: Single
Colis: Unique

€ Pag. listino - Price list - Liste des prix

46

● Standard

○ Disponibilità da richiedere, prezzo a listino
On enquiry, standard price-list / Stock à vérifier

★ Solo a richiesta
Only on request / Sur demande

N

USO GENERALE

General purpose - Usage Général

MASCHI A MACCHINA, FILETTATURA SINISTRA

LEFT THREAD MACHINE TAPS - TARAUDS MACHINE GAUCHE

DIN 374

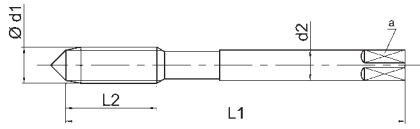

DIN 374

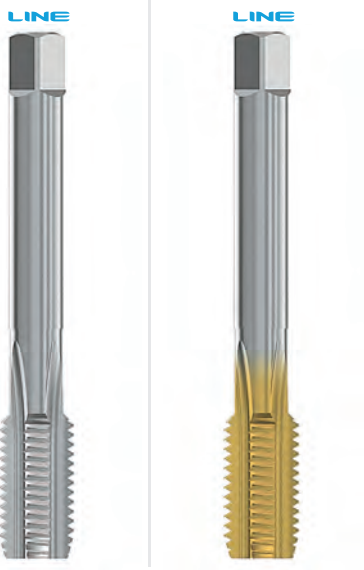
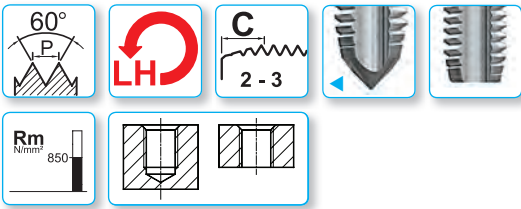
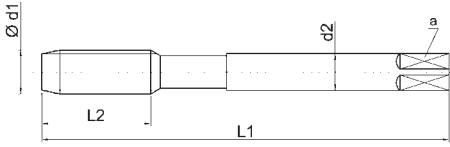

Profond. di filettatura - Thread depth - Profond. de filetage

1,5xD

1,5xD

Materiale - Material - Matériau

HSSE

HSSE

Tolleranza - Tolerance - Tolérance

ISO2/6H

ISO2/6H

Trattamento superficiale - Surface treatment - Revêtement

BR

TiN

Numero gruppi materiali

Material's groups number

Nombre de groupes du matériau

1.1 1.2 1.3 1.4 3.4

1.1 1.2 1.3 1.4 3.4

4.2 4.3 5.2 5.3

4.2 4.3 5.2 5.3

8.2

8.2

DIN 374	Ød1 MF	P mm	L1	L2	d2 h9	a h12	Z	
◀	6	0,75	80	16	4,5	3,4	3	5,25
◀	8	1	90	18	6	4,9	3	7
◀	10	1	90	15	7	5,5	3	9
◀	10	1,25	100	20	7	5,5	3	8,75
	12	1,25	100	22	9	7	3	10,75
	12	1,5	100	22	9	7	3	10,5
	14	1,5	100	22	11	9	4	12,5
	16	1,5	100	22	12	9	4	14,5
	18	1,5	110	25	14	11	4	16,5
	20	1,5	125	25	16	12	4	18,5

CODICE - CODE	
E21MF...LH	E21MF...LH-T
○	○
○	○
○	○
○	○
○	○
○	○
○	○
○	○
○	○
○	○

Confezione / Box / Colis:
M3 – M10: 10 pezzi / pcs
M12 – M16: 5 pezzi / pcs

€ Pag. listino - Price list - Liste des prix

46

46

• Standard

○ Disponibilità da richiedere, prezzo a listino
On enquiry, standard price-list / Stock à vérifier

★ Solo a richiesta
Only on request / Sur demande

MF Filettatura metrica ISO passo fine DIN 13

ISO metric fine thread DIN13

Metrisches ISO-Feingewinde DIN 13 – Maschinengewindebohrer
 Filetage métrique ISO à pas fin DIN 13 – Tarauds machine
 Rosca ISO métrica fina DIN 13 – Machos de roscar a máquina



GHISA
Cast Iron - Fonte

MASCHI A MACCHINA

MACHINE TAPS - TARAUDS MACHINE

DIN 371

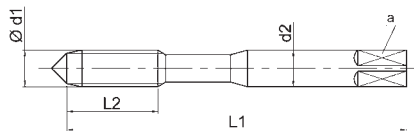

DIN 371

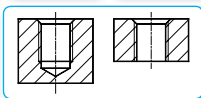
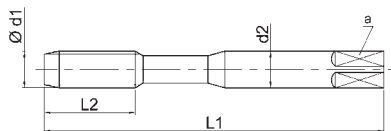

Profond. di filettatura - Thread depth - Profond. de filetage

Materiale - Material - Matériau

Tolleranza - Tolerance - Tolérance

Trattamento superficiale - Surface treatment - Revêtement

Al Si>10%,
Ottone / Brass / Laiton
Bronzo / Bronze / Bronze
truciolo corto / short chip /
coupeaux courts

Numero gruppi materiali
Material's groups number
Nombre de groupes du matériau

3xD	3xD	3,5xD
HSSE	HSSE	HSSE
6HX	6HX	6HX
NQ	TiCN	TiCN
3.1 3.2 3.3 3.4 3.5	3.1 3.2 3.3 3.4 3.5	3.1 3.2 3.3 3.4 3.5
4.3 4.4 4.5 4.6 5.3	4.3 4.4 4.5 4.6 5.3	4.3 4.4 4.5 4.6 5.3
8.2 10.1	8.2 10.1	8.2 10.1

DIN 371	Ød1 MF	P mm	L1	L2	d2 h9	a h12	Z	
◀	4	0,5	63	13	4,5	3,4	3	3,5
◀	5	0,5	70	13	6	4,9	3	4,5
◀	6	0,75	80	16	6	4,9	3	5,25
◀	8	1	90	18	8	6,2	4	7
◀	10	1	90	15	10	8	4	9
◀	10	1,25	100	20	10	8	4	8,75
	6	0,75	80	16	6	4,9	3	5,25
	8	1	90	18	8	6,2	4	7
	10	1	90	15	10	8	4	9
	10	1,25	100	20	10	8	4	8,75

CODICE - CODE		
E26MF...NQ	E26MF...CT	
-	○	
-	○	
-	○	
○	●	
○	○	
○	●	
E26MF...SP-NQ	E26MF...SP-CT	E26MF...FOR-CT
★	★	★
○	○	○
○	○	○
○	○	○

Confezione / Box / Colis:
M3 – M10: 10 pezzi / pcs
M12 – M16: 5 pezzi / pcs

€ Pag. listino - Price list - Liste des prix

46

46

46

● Standard

○ Disponibilità da richiedere, prezzo a listino
On enquiry, standard price-list / Stock à vérifier

★ Solo a richiesta
Only on request / Sur demande

MASCHI A MACCHINA

MACHINE TAPS - TARAUDS MACHINE

DIN 374

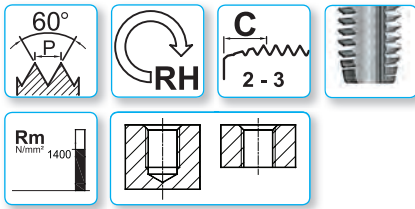
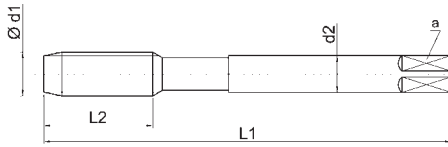

Profond. di filettatura - Thread depth - Profond. de filetage

Materiale - Material - Matériau

Tolleranza - Tolerance - Tolérance

Trattamento superficiale - Surface treatment - Revêtement

Al Si>10%,
Ottone / Brass / Laiton
Bronzo / Bronze / Bronze
truciolo corto / short chip /
coupeaux courts

Numero gruppi materiali
Material's groups number
Nombre de groupes du matériau

TOP



TOP



TOP



TOP



ADITAPS

3xD

3,5xD

3,5xD

3xD

PM3

PM3

PM3

PM3

6HX

6HX

6HX

6HX

TiAlN

TiAlN

TiAlN

TXS

3.1 3.2 3.3 3.4 3.5

3.1 3.2 3.3 3.4 3.5

3.1 3.2 3.3 3.4 3.5

3.1 3.2 3.3 3.4 3.5

4.4 5.3 5.4

4.4 5.3 5.4

4.4 5.3 5.4

4.4 5.3 5.4

10.1

10.1

10.1

10.1

DIN 374	Ød1 MF	P mm	L1	L2	d2 h9	a h12	Z	
	8	1	90	18	6	4,9	4	7
	10	1	90	15	7	5,5	4	9
	10	1,25	100	20	7	5,5	4	8,75
	12	1,25	100	22	9	7	4	10,75
	12	1,5	100	22	9	7	4	10,5
	14	1,5	100	22	11	9	4	12,5
	16	1,5	100	22	12	9	4	14,5
	18	1,5	110	25	14	11	5	16,5
	20	1,5	125	25	16	12	5	18,5
	22	1,5	125	25	18	14,5	6	20,5
	24	1,5	140	25	18	14,5	6	22,5

CODICE - CODE

K27MF...TX

K27MF...FOR-TX

K27MF...FORY-TX

K27MF...TXS

<input type="radio"/>
<input type="radio"/>
<input type="radio"/>
<input type="radio"/>
<input type="radio"/>
<input type="radio"/>
<input type="radio"/>
<input type="radio"/>
<input type="radio"/>
<input type="radio"/>
<input type="radio"/>
<input type="radio"/>
<input type="radio"/>
<input type="radio"/>
<input type="radio"/>
<input type="radio"/>
<input type="radio"/>
<input type="radio"/>
<input type="radio"/>
<input type="radio"/>

<input type="radio"/>
<input type="radio"/>
<input type="radio"/>
<input type="radio"/>
<input type="radio"/>
<input type="radio"/>
<input type="radio"/>
<input type="radio"/>
<input type="radio"/>
<input type="radio"/>
<input type="radio"/>
<input type="radio"/>
<input type="radio"/>
<input type="radio"/>
<input type="radio"/>
<input type="radio"/>
<input type="radio"/>
<input type="radio"/>
<input type="radio"/>

<input type="radio"/>
<input type="radio"/>
<input type="radio"/>
<input type="radio"/>
<input type="radio"/>
<input type="radio"/>
<input type="radio"/>
<input type="radio"/>
<input type="radio"/>
<input type="radio"/>
<input type="radio"/>
<input type="radio"/>
<input type="radio"/>
<input type="radio"/>
<input type="radio"/>
<input type="radio"/>
<input type="radio"/>
<input type="radio"/>
<input type="radio"/>

<input type="radio"/>
<input type="radio"/>
<input type="radio"/>
<input type="radio"/>
<input type="radio"/>
<input type="radio"/>
<input type="radio"/>
<input type="radio"/>
<input type="radio"/>
<input type="radio"/>
<input type="radio"/>
<input type="radio"/>
<input type="radio"/>
<input type="radio"/>
<input type="radio"/>
<input type="radio"/>
<input type="radio"/>
<input type="radio"/>
<input type="radio"/>

Esecuzione in metallo duro integrale:
In HM material:
En carbure:
Pag. 99

Confezione / Box / Colis:
M3 – M12: 5 pezzi / pcs
>M12: singoli / single pcs

€ Pag. listino - Price list - Liste des prix

47

48

48

47

● Standard

○ Disponibilità da richiedere, prezzo a listino
On enquiry, standard price-list / Stock à vérifier

★ Solo a richiesta
Only on request / Sur demande

DIN 374

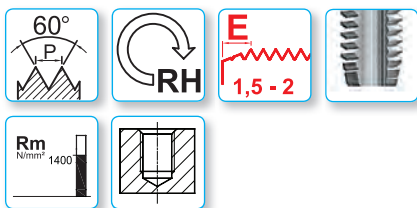
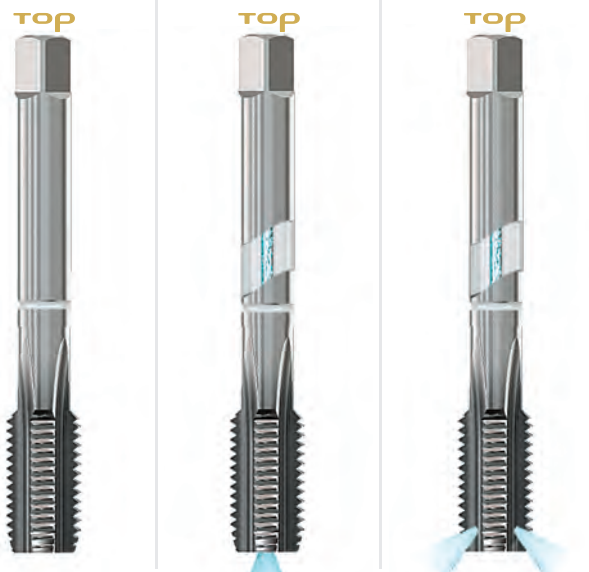
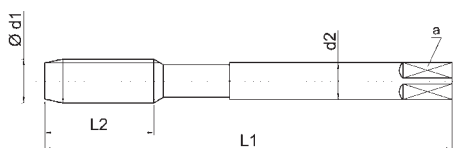

Profond. di filettatura - Thread depth - Profond. de filetage

Materiale - Material - Matériau

Tolleranza - Tolerance - Tolérance

Trattamento superficiale - Surface treatment - Revêtement

Al Si > 10%,
Ottone / Brass / Laiton
Bronzo / Bronze / Bronze
truciolo corto / short chip /
coupeaux courts

Numero gruppi materiali
Material's groups number
Nombre de groupes du matériau

DIN 374	Ød1 MF	P mm	L ₁	L ₂	d ₂ h9	a h12	Z	
	8	1	90	18	6	4,9	4	7
	10	1	90	15	7	5,5	4	9
	10	1,25	100	20	7	5,5	4	8,75
	12	1,25	100	22	9	7	4	10,75
	12	1,5	100	22	9	7	4	10,5
	14	1,5	100	22	11	9	4	12,5
	16	1,5	100	22	12	9	4	14,5
	18	1,5	110	25	14	11	5	16,5
	20	1,5	125	25	16	12	5	18,5
	22	1,5	125	25	18	14,5	6	20,5
	24	1,5	140	25	18	14,5	6	22,5

	3xD	3,5xD	3,5xD
	PM3	PM3	PM3
	6HX	6HX	6HX
	TiAIN	TiAIN	TiAIN
	3.1 3.2 3.3 3.4 3.5	3.1 3.2 3.3 3.4 3.5	3.1 3.2 3.3 3.4 3.5
	4.4 5.3	4.4 5.3	4.4 5.3
	10.1	10.1	10.1

	CODICE - CODE		
	K27EMF...TX	K27EMF...FOR-TX	K27EMF...FORY-TX
<input type="checkbox"/>	<input type="checkbox"/>	<input type="checkbox"/>	
<input type="checkbox"/>	<input type="checkbox"/>	<input type="checkbox"/>	
<input type="checkbox"/>	<input type="checkbox"/>	<input type="checkbox"/>	
<input type="checkbox"/>	<input type="checkbox"/>	<input type="checkbox"/>	
<input type="checkbox"/>	<input type="checkbox"/>	<input type="checkbox"/>	
<input type="checkbox"/>	<input type="checkbox"/>	<input type="checkbox"/>	
<input type="checkbox"/>	<input type="checkbox"/>	<input type="checkbox"/>	
<input type="checkbox"/>	<input type="checkbox"/>	<input type="checkbox"/>	
<input type="checkbox"/>	<input type="checkbox"/>	<input type="checkbox"/>	
<input type="checkbox"/>	<input type="checkbox"/>	<input type="checkbox"/>	
<input type="checkbox"/>	<input type="checkbox"/>	<input type="checkbox"/>	
<input type="checkbox"/>	<input type="checkbox"/>	<input type="checkbox"/>	
<input type="checkbox"/>	<input type="checkbox"/>	<input type="checkbox"/>	
<input type="checkbox"/>	<input type="checkbox"/>	<input type="checkbox"/>	
<input type="checkbox"/>	<input type="checkbox"/>	<input type="checkbox"/>	
<input type="checkbox"/>	<input type="checkbox"/>	<input type="checkbox"/>	
<input type="checkbox"/>	<input type="checkbox"/>	<input type="checkbox"/>	
<input type="checkbox"/>	<input type="checkbox"/>	<input type="checkbox"/>	
<input type="checkbox"/>	<input type="checkbox"/>	<input type="checkbox"/>	
<input type="checkbox"/>	<input type="checkbox"/>	<input type="checkbox"/>	
<input type="checkbox"/>	<input type="checkbox"/>	<input type="checkbox"/>	
<input type="checkbox"/>	<input type="checkbox"/>	<input type="checkbox"/>	
<input type="checkbox"/>	<input type="checkbox"/>	<input type="checkbox"/>	
<input type="checkbox"/>	<input type="checkbox"/>	<input type="checkbox"/>	
<input type="checkbox"/>	<input type="checkbox"/>	<input type="checkbox"/>	
<input type="checkbox"/>	<input type="checkbox"/>	<input type="checkbox"/>	

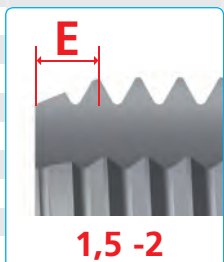

MF Filettatura metrica ISO passo fine DIN 13

ISO metric fine thread DIN13
Metrisches ISO-Feingewinde DIN 13 – Maschinengewindebohrer
Filetage métrique ISO à pas fin DIN 13 – Tardaubs machine
Rosca ISO métrica fina DIN 13 – Machos de rosca a máquina



**SYNCHRO
RIGID**

MASCHIATURA RIGIDA SINCRONIZZATA
Rigid Tapping Synchro - Taraudage rigide synchronisé

MASCHI A MACCHINA

MACHINE TAPS - TARAUDS MACHINE

MF

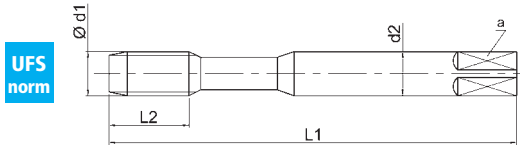

UFS
norm

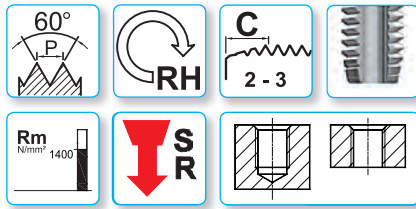

Profond. di filettatura - Thread depth - Profond. de filetage

Materiale - Material - Matériau

Tolleranza - Tolerance - Tolérance

Trattamento superficiale - Surface treatment - Revêtement

Ghisa / Cast iron / Fonte
Acciaio alta resistenza
Hight resistance Steel
Acier haute résistance
Al Si > 10%

Numero gruppi materiali
Material's groups number
Nombre de groupes du matériau

UFS norm	Ød1 MF	P mm	L1	L2	d2 h6	a h12	Z	
8	1	90	13	8	6,2	4	7	
10	1	100	15	10	8	4	9	
10	1,25	100	15	10	8	4	8,75	
12	1,25	110	18	12	9	4	10,75	
12	1,5	110	18	12	9	4	10,5	
14	1,5	110	20	12	9	4	12,5	
16	1,5	110	20	16	12	4	14,5	

top



top



top



3xD	3,5xD	3,5xD
PM3	PM3	PM3
6HX	6HX	6HX
TXC	TXC	TXC
1.5 1.6	1.5 1.6	1.5 1.6
3.1 3.2 3.3 3.4 3.5	3.1 3.2 3.3 3.4 3.5	3.1 3.2 3.3 3.4 3.5
4.3 4.4 4.5 4.6 5.3 5.4	4.3 4.4 4.5 4.6 5.3 5.4	4.3 4.4 4.5 4.6 5.3 5.4
8.2 8.3 10.1	8.2 8.3 10.1	8.2 8.3 10.1

S20MF...TXC	CODICE - CODE	
	S20MF...FOR-TXC	S20MF...FORY-TXC
<input type="checkbox"/>	<input type="checkbox"/>	<input type="checkbox"/>
<input type="checkbox"/>	<input type="checkbox"/>	<input type="checkbox"/>
<input type="checkbox"/>	<input type="checkbox"/>	<input type="checkbox"/>
<input type="checkbox"/>	<input type="checkbox"/>	<input type="checkbox"/>
<input type="checkbox"/>	<input type="checkbox"/>	<input type="checkbox"/>
<input type="checkbox"/>	<input type="checkbox"/>	<input type="checkbox"/>
<input type="checkbox"/>	<input type="checkbox"/>	<input type="checkbox"/>
<input type="checkbox"/>	<input type="checkbox"/>	<input type="checkbox"/>
<input type="checkbox"/>	<input type="checkbox"/>	<input type="checkbox"/>
<input type="checkbox"/>	<input type="checkbox"/>	<input type="checkbox"/>
<input type="checkbox"/>	<input type="checkbox"/>	<input type="checkbox"/>
<input type="checkbox"/>	<input type="checkbox"/>	<input type="checkbox"/>
<input type="checkbox"/>	<input type="checkbox"/>	<input type="checkbox"/>
<input type="checkbox"/>	<input type="checkbox"/>	<input type="checkbox"/>
<input type="checkbox"/>	<input type="checkbox"/>	<input type="checkbox"/>
<input type="checkbox"/>	<input type="checkbox"/>	<input type="checkbox"/>
<input type="checkbox"/>	<input type="checkbox"/>	<input type="checkbox"/>
<input type="checkbox"/>	<input type="checkbox"/>	<input type="checkbox"/>
<input type="checkbox"/>	<input type="checkbox"/>	<input type="checkbox"/>
<input type="checkbox"/>	<input type="checkbox"/>	<input type="checkbox"/>
<input type="checkbox"/>	<input type="checkbox"/>	<input type="checkbox"/>
<input type="checkbox"/>	<input type="checkbox"/>	<input type="checkbox"/>
<input type="checkbox"/>	<input type="checkbox"/>	<input type="checkbox"/>
<input type="checkbox"/>	<input type="checkbox"/>	<input type="checkbox"/>
<input type="checkbox"/>	<input type="checkbox"/>	<input type="checkbox"/>
<input type="checkbox"/>	<input type="checkbox"/>	<input type="checkbox"/>

A richiesta:
On request:
Sur demande:
Con Weldon DIN1835 B



HR **ALTA RESISTENZA**
High Resistance - Haute Résistance

MASCHI A MACCHINA
MACHINE TAPS - TARAUDS MACHINE

DIN 371

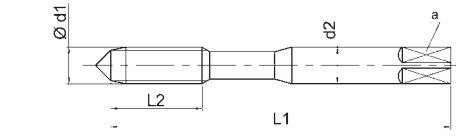

DIN 374

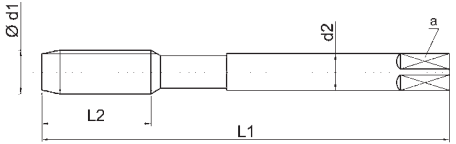
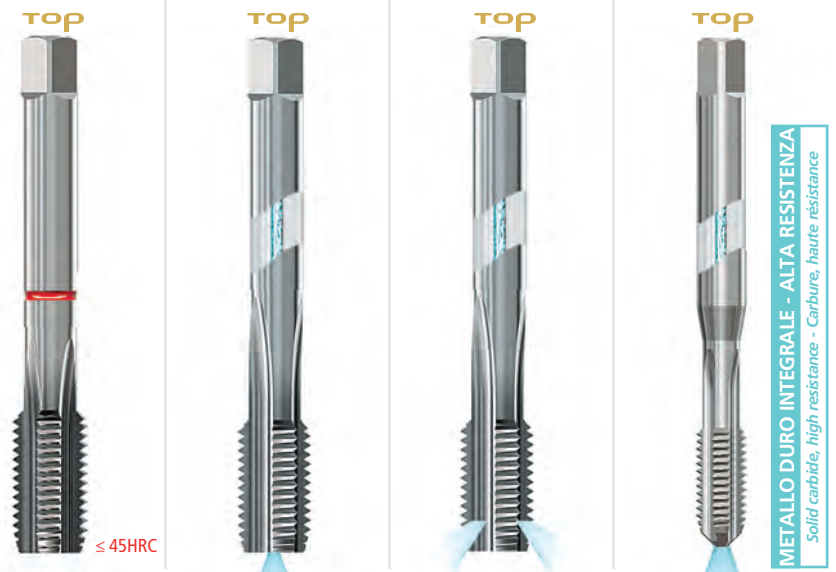
METALLO DURO INTEGRALE - ALTA RESISTENZA
Solid carbide, high resistance - Carbure, haute résistance

Profond. di filettatura - Thread depth - Profond. de filetage

Materiale - Material - Matériau

Tolleranza - Tolerance - Tolérance

Trattamento superficiale - Surface treatment - Revêtement

Ghisa / Cast iron / Fonte
Al Si > 10%
Ottone / Brass / Laiton
Bronzo / Bronze / Bronze
truciolo corto / short chip /
coupeaux courts

Numero gruppi materiali
Material's groups number
Nombre de groupes du matériau

2xD	3,5xD	3,5xD	3,5xD
PM3	PM3	PM3	MDI-HM
6HX	ISO2/6H	ISO2/6H	6HX
TXC	TXC	TXC	BR
1.5 1.6	1.3 1.4 1.5 1.6	1.3 1.4 1.5 1.6	3.1 3.2 3.3 3.4 3.5
4.3 4.4 4.5 4.6 5.3 5.4	3.1 3.2 3.3 3.4 3.5	3.1 3.2 3.3 3.4 3.5	4.3 4.4 4.5 4.6
8.2 8.3 10.1	4.3 4.4 4.5 4.6 5.3 5.4	4.3 4.4 4.5 4.6 5.3 5.4	5.3 5.4 8.2 8.3
	8.2 8.3 10.1	8.2 8.3 10.1	10.1

DIN 371	Ød1 MF	P mm	L1	L2	d2 h9	a h12	Z	
	8	1	90	18	8	6,2	-	7
	10	1	100	20	10	8	-	9
	10	1,25	100	20	10	8	-	8,75

CODICE - CODE			
			*HM20MF...FOR
			*
			*
			*

DIN 374	Ød1 MF	P mm	L1	L2	d2 h9	a h12	Z	
	8	1	90	18	6	4,9	4	7
	10	1	90	15	7	5,5	4	9
	10	1,25	100	20	7	5,5	4	8,75
	12	1,25	100	22	9	7	4	10,75
	12	1,5	100	22	9	7	4	10,5
	14	1,5	100	22	11	9	4	12,5
	16	1,5	100	22	12	9	4	14,5

CODICE - CODE			
K21MF...TXC			*HM21MF...FOR
○			-
○			-
○			-
○			*
○			*
○			*
○			*
	K23MF...FOR-TXC	K23MF...FOR-TXC	*A richiesta rivestimento: On request coating: Sur demande revêtement:
	○	○	
	○	○	TiCN
	○	○	
	○	○	
	○	○	
	○	○	
	○	○	

N

USO GENERALE

General purpose - Usage Général

MASCHI A MACCHINA

MACHINE TAPS - TARAUDS MACHINE

DIN 371

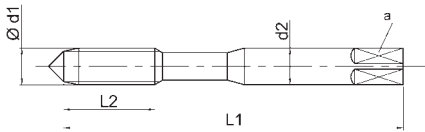

DIN 371

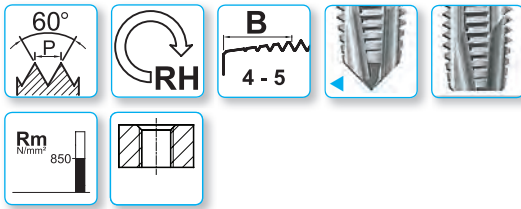
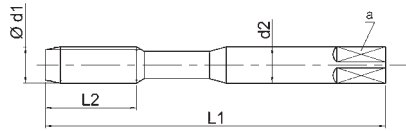

Profond. di filettatura - Thread depth - Profond. de filetage

Materiale - Material - Matériau

Tolleranza - Tolerance - Tolérance

Trattamento superficiale - Surface treatment - Revêtement

3xD	3xD	3xD	3xD
HSSE	HSSE	HSSE	HSSE
ISO2/6H	ISO2/6H	ISO2/6H	ISO2/6H
BR	V	TiN	TXC
1.1 1.2 1.3 1.4	1.1 1.2 1.3 1.4	1.1 1.2 1.3 1.4	1.1 1.2 1.3 1.4
4.1 4.2	4.1 4.2	3.3 3.4	2.1 2.2 3.3 3.4
5.1 5.2	5.1 5.2	4.1 4.2 4.3	4.2 4.3
	6.1 7.1	5.1 5.2	5.2

Numero gruppi materiali
Material's groups number
Nombre de groupes du matériau

DIN 371	Ød1 MF	P mm	L1	L2	d2 h9	a h12	Z	Icon
4	0,5	63	13	4,5	3,4	3	3,5	
5	0,5	70	13	6	4,9	3	4,5	
6	0,75	80	16	6	4,9	3	5,25	
7	0,75	80	16	7	5,5	3	6,25	
8	0,75	90	18	8	6,2	3	7,25	
8	1	90	18	8	6,2	3	7	
9	1	90	18	9	7	3	8	
10	0,75	90	15	10	8	3	9,25	
10	1	90	15	10	8	3	9	
10	1,25	100	20	10	8	3	8,75	

E24MF...	CODICE - CODE		
	E24MF...V	E24MF...T	E24MF...TXC
○	○	○	○
○	○	○	○
○	○	○	○
○	○	○	○
○	○	○	○
●	●	○	○
○	○	○	○
○	○	○	○
●	●	○	○
●	●	○	○

Segue diametri
Diameters, to be continued
Diamètres à suivre

Pag. 101...103

Confezione / Box / Colis:
M3 – M10: 10 pezzi / pcs
M12 – M16: 5 pezzi / pcs

€ Pag. listino - Price list - Liste des prix

49

49

49

49

● Standard

○ Disponibilità da richiedere, prezzo a listino
On enquiry, standard price-list / Stock à vérifier

★ Solo a richiesta
Only on request / Sur demande

N **USO GENERALE**
 General purpose - Usage Général

MASCHI A MACCHINA
 MACHINE TAPS - TARAUDS MACHINE

DIN 374

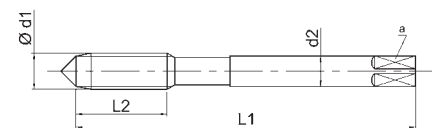

DIN 374

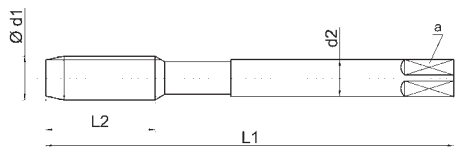

LINE



LINE



LINE



LINE



MF



Profond. di filettatura - Thread depth - Profond. de filetage

Materiale - Material - Matériau

Tolleranza - Tolerance - Tolérance

Trattamento superficiale - Surface treatment - Revêtement

3xD	3xD	3xD	3xD
HSSE	HSSE	HSSE	HSSE
ISO2/6H	ISO2/6H	ISO2/6H	ISO2/6H
BR	V	TiN	TXC
1.1 1.2 1.3 1.4	1.1 1.2 1.3 1.4	1.1 1.2 1.3 1.4	1.1 1.2 1.3 1.4
4.1 4.2	4.1 4.2	3.3 3.4	2.1 2.2 3.3 3.4
5.1 5.2	5.1 5.2	4.1 4.2 4.3	4.2 4.3
	6.1 7.1	5.1 5.2	5.2

Numero gruppi materiali
 Material's groups number
 Nombre de groupes du matériau

DIN 374	Ød1 MF	P mm	L ₁	L ₂	d ₂ h9	a h12	Z	Z
◀	6	0,75	80	16	4,5	3,4	3	5,25
◀	8	1	90	18	6	4,9	3	7
◀	10	1	90	15	7	5,5	3	9
◀	10	1,25	100	20	7	5,5	3	8,75
	12	1	100	22	9	7	3	11
	12	1,25	100	22	9	7	3	10,75
	12	1,5	100	22	9	7	3	10,5
	14	1	100	22	11	9	4	13
	14	1,25	100	22	11	9	4	12,75
	14	1,5	100	22	11	9	4	12,5
	16	1	100	22	12	9	4	15
	16	1,5	100	22	12	9	4	14,5
	18	1	110	25	14	11	4	17
	18	1,5	110	25	14	11	4	16,5
	20	1	125	25	16	12	4	19
	20	1,5	125	25	16	12	4	18,5
	22	1	125	25	18	14,5	4	21
	22	1,5	125	25	18	14,5	4	20,5
	24	1	140	25	18	14,5	4	23
	24	1,5	140	25	18	14,5	4	22,5
	24	2	140	25	18	14,5	4	22
	25	1,5	140	25	18	14,5	4	23,5
	25	2	140	25	18	14,5	4	23
	26	1,5	140	25	18	14,5	4	24,5
	26	2	140	25	18	14,5	4	24

E25MF...	CODICE - CODE		
	E25MF...V	E25MF...T	E25MF...TXC
○	○	○	○
●	○	○	○
○	○	○	○
●	○	○	○
○	○	○	○
●	●	●	○
○	○	○	○
○	○	○	○
○	○	○	○
●	●	●	○
○	○	○	○
○	○	○	○
○	○	○	○
○	○	○	○
○	○	○	○
○	○	○	○
○	○	○	○
○	○	○	○
○	○	○	○
○	○	○	○
○	○	○	○

Segue diametri
 Diameters, to be continued
 Diamètres à suivre

▶ Pag. 102...103

Confezione / Box / Colis: M3 – M10: 10 pezzi / pcs M12 – M16: 5 pezzi / pcs	€ Pag. listino - Price list - Liste des prix ● Standard	50	50	51	51
		○ Disponibilità da richiedere, prezzo a listino On enquiry, standard price-list / Stock à vérifier		★ Solo a richiesta Only on request / Sur demande	

MF Filettatura metrica ISO passo fine DIN 13

ISO metric fine thread DIN13

Metrisches ISO-Feingewinde DIN 13 - Maschinengewindebohrer
Filetage métrique ISO à pas fin DIN 13 - Tarauds machine
Rosca ISO métrica fina DIN 13 - Machos de roscar a máquina



N

USO GENERALE
General purpose - Usage Général

MASCHI A MACCHINA

MACHINE TAPS - TARAUDS MACHINE

MF

DIN 374

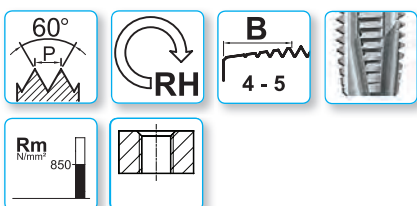
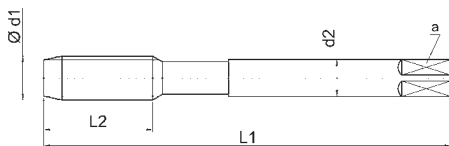

Profond. di filettatura - Thread depth - Profond. de filetage

Materiale - Material - Matériau

Tolleranza - Tolerance - Tolérance

Trattamento superficiale - Surface treatment - Revêtement

Numero gruppi materiali
Material's groups number
Nombre de groupes du matériau

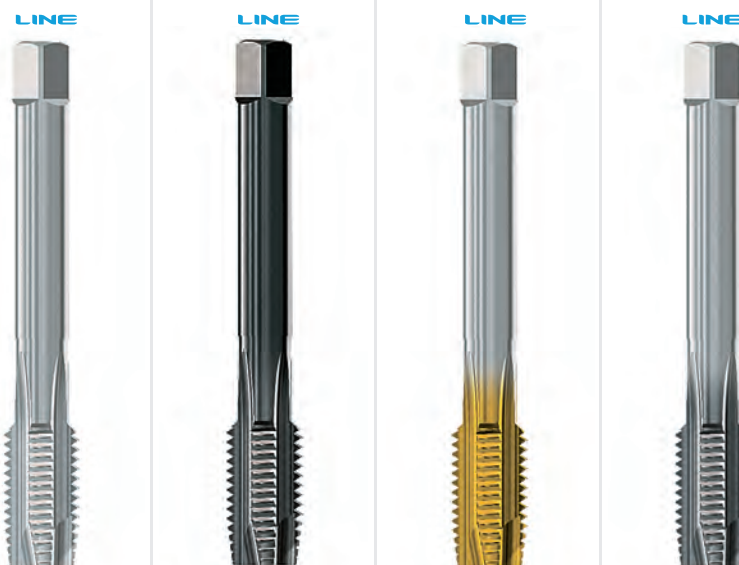

3xD	3xD	3xD	3xD
HSSE	HSSE	HSSE	HSSE
ISO2/6H	ISO2/6H	ISO2/6H	ISO2/6H
BR	V	TiN	TXC
1.1 1.2 1.3 1.4	1.1 1.2 1.3 1.4	1.1 1.2 1.3 1.4	1.1 1.2 1.3 1.4
4.1 4.2	4.1 4.2	3.3 3.4	2.1 2.2 3.3 3.4
5.1 5.2	5.1 5.2	4.1 4.2 4.3	4.2 4.3
	6.1 7.1	5.1 5.2	5.2

DIN 374	$\varnothing d_1$ MF	P mm	L ₁	L ₂	d ₂ h9	a h12	Z	
27	1	140	25	20	16	4	26	
27	1,5	140	25	20	16	4	25,5	
27	2	140	25	20	16	4	25	
28	1,5	140	25	20	16	4	26,5	
28	2	140	25	20	16	4	26	
30	1,5	150	28	22	18	4	28,5	
30	2	150	28	22	18	4	28	
30	3	180	46	22	18	4	27	
32	1,5	150	28	22	18	5	30,5	
32	2	150	28	22	18	5	30	
33	1,5	160	30	25	20	5	31,5	
33	2	160	30	25	20	5	31	
33	3	180	46	25	20	4	30	
34	1,5	170	30	28	22	5	32,5	
35	1,5	170	30	28	22	5	33,5	
36	1,5	170	30	28	22	5	34,5	
36	2	170	30	28	22	5	34	
36	3	200	50	28	22	4	33	
38	1,5	170	30	28	22	6	36,5	
39	1,5	170	30	32	24	6	37,5	
40	1,5	170	30	32	24	6	38,5	
40	2	170	30	32	24	6	38	
40	3	200	50	32	24	5	37	
42	1,5	170	30	32	24	6	40,5	
42	2	170	30	32	24	6	40	
42	3	200	55	32	24	5	39	

CODICE - CODE			
E25MF...	E25MF...V	E25MF...T	E25MF...TXC
<input type="radio"/>	<input type="radio"/>	<input type="radio"/>	<input type="radio"/>
<input checked="" type="radio"/>	<input type="radio"/>	<input type="radio"/>	<input type="radio"/>
<input type="radio"/>	<input type="radio"/>	<input type="radio"/>	<input type="radio"/>
<input type="radio"/>	<input type="radio"/>	<input type="radio"/>	<input type="radio"/>
<input checked="" type="radio"/>	<input type="radio"/>	<input type="radio"/>	<input type="radio"/>
<input type="radio"/>	<input type="radio"/>	<input type="radio"/>	<input checked="" type="radio"/>
<input type="radio"/>	<input type="radio"/>	<input type="radio"/>	<input checked="" type="radio"/>
<input type="radio"/>	<input type="radio"/>	<input type="radio"/>	<input checked="" type="radio"/>
<input type="radio"/>	<input type="radio"/>	<input type="radio"/>	<input checked="" type="radio"/>
<input type="radio"/>	<input type="radio"/>	<input type="radio"/>	<input checked="" type="radio"/>
<input type="radio"/>	<input type="radio"/>	<input type="radio"/>	<input checked="" type="radio"/>
<input type="radio"/>	<input type="radio"/>	<input type="radio"/>	<input checked="" type="radio"/>
<input type="radio"/>	<input type="radio"/>	<input type="radio"/>	<input checked="" type="radio"/>
<input type="radio"/>	<input type="radio"/>	<input type="radio"/>	<input checked="" type="radio"/>
<input type="radio"/>	<input type="radio"/>	<input type="radio"/>	<input checked="" type="radio"/>
<input type="radio"/>	<input type="radio"/>	<input type="radio"/>	<input checked="" type="radio"/>
<input type="radio"/>	<input type="radio"/>	<input type="radio"/>	<input checked="" type="radio"/>
<input type="radio"/>	<input type="radio"/>	<input type="radio"/>	<input checked="" type="radio"/>
<input type="radio"/>	<input type="radio"/>	<input type="radio"/>	<input checked="" type="radio"/>
<input type="radio"/>	<input type="radio"/>	<input type="radio"/>	<input checked="" type="radio"/>

Segue diametri
Diameters, to be continued
Diamètres à suivre

N

USO GENERALE

General purpose - Usage Général

MASCHI A MACCHINA

MACHINE TAPS - TARAUDS MACHINE

DIN 374

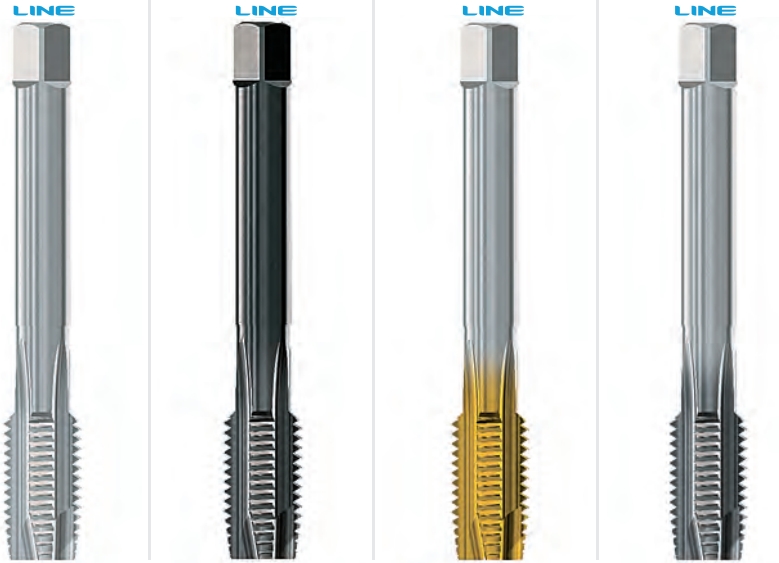
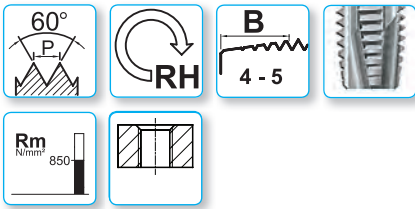
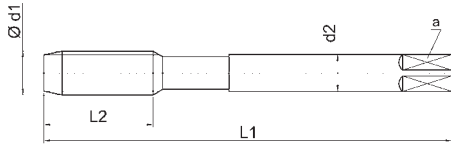

MF

Profond. di filettatura - Thread depth - Profond. de filetage

Materiale - Material - Matériau

Tolleranza - Tolerance - Tolérance

Trattamento superficiale - Surface treatment - Revêtement

Numero gruppi materiali
Material's groups number
Nombre de groupes du matériau

3xD	3xD	3xD	3xD
HSSE	HSSE	HSSE	HSSE
ISO2/6H	ISO2/6H	ISO2/6H	ISO2/6H
BR	V	TiN	TXC

1.1 1.2 1.3 1.4	1.1 1.2 1.3 1.4	1.1 1.2 1.3 1.4	1.1 1.2 1.3 1.4
4.1 4.2	4.1 4.2	3.3 3.4	2.1 2.2 3.3 3.4
5.1 5.2	5.1 5.2	4.1 4.2 4.3	4.2 4.3
	6.1 7.1	5.1 5.2	5.2

DIN 374	Ød1 MF	P mm	L ₁	L ₂	d ₂ h9	a h12	Z	
■	45	1	180	32	36	29	6	44
■	45	1,5	180	32	36	29	6	43,5
■	45	2	180	32	36	29	6	43
■	45	3	200	50	36	29	5	42
■	48	1,5	190	32	36	29	6	46,5
■	48	2	190	32	36	29	6	46
■	*48	3	220	65	36	29	6	45
■	50	1,5	190	32	36	29	6	48,5
■	50	2	190	32	36	29	6	48
■	*50	3	220	65	36	29	6	47
■	52	1,5	190	32	40	32	6	50,5
■	52	2	190	32	40	32	6	50
■	*52	3	220	65	40	32	6	49

■ = Acciaio HSS / HSS Steel / Acier HSS

* Dimensioni a norma UFS / Dimensions according UFS' norms /
Dimensions selon norme UFS

E25MF...	CODICE - CODE			E25MF...TXC
	E25MF...V	E25MF...T		
○	○	○	*	
○	○	○	*	
○	○	○	*	
○	○	○	*	
○	○	○	*	
○	○	○	*	
○	○	○	*	
○	○	○	*	
○	○	○	*	
○	○	○	*	
○	○	○	*	
○	○	○	*	
○	○	○	*	
○	○	○	*	

Confezione / Box / Colis: M3 – M10: 10 pezzi / pcs M12 – M16: 5 pezzi / pcs	€ Pag. listino - Price list - Liste des prix	50	50	51	51
	● Standard	○ Disponibilità da richiedere, prezzo a listino On enquiry, standard price-list / Stock à vérifier		★ Solo a richiesta Only on request / Sur demande	

MF

Filettatura metrica ISO passo fine DIN 13

ISO metric fine thread DIN13

Metrisches ISO-Feingewinde DIN 13 – Maschinengewindebohrer
 Filetage métrique ISO à pas fin DIN 13 – Tarauds machine
 Rosca ISO métrica fina DIN 13 – Machos de roscar a máquina



N

USO GENERALE
 General purpose - Usage Général

MASCHI A MACCHINA, FILETTATURA SINISTRA

LEFT THREAD MACHINE TAPS - TARAUDS MACHINE GAUCHE

MF

DIN 371

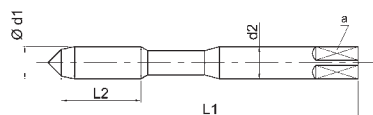

DIN 374

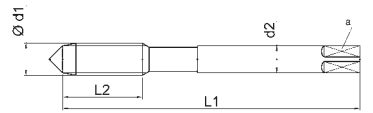

DIN 374

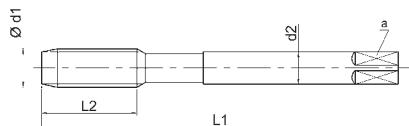

LINE



LINE



Profond. di filettatura - Thread depth - Profond. de filetage

Materiale - Material - Matériau

Tolleranza - Tolerance - Tolérance

Trattamento superficiale - Surface treatment - Revêtement

3xD	3xD
HSSE	HSSE
6H	6H
BR	TiN
1.1 1.2 1.3 1.4	1.1 1.2 1.3 1.4
4.1 4.2	3.3 3.4
5.1 5.2	4.1 4.2 4.3
	5.1 5.2

Numero gruppi materiali
 Material's groups number
 Nombre de groupes du matériau

DIN	Ød1	P	L1	L2	d2	a	Z	
371	MF	mm			h9	h12		
◀	8	1	90	18	8	6,2	3	7
◀	10	1	90	15	10	8	3	9
◀	10	1,25	100	20	10	8	3	8,75

CODICE - CODE	
E24MF...LH	E24MF...LH-T
○	○
○	○
○	○

DIN	Ød1	P	L1	L2	d2	a	Z	
374	MF	mm			h9	h12		
◀	8	1	90	18	6	4,9	3	7
◀	10	1	90	15	7	5,5	3	9
◀	10	1,25	100	20	7	5,5	3	8,75
	12	1,25	100	22	9	7	3	10,75
	12	1,5	100	22	9	7	3	10,5
	14	1,5	100	22	11	9	4	12,5
	16	1,5	100	22	12	9	4	14,5

CODICE - CODE	
E25MF...LH	E25MF...LH-T
○	○
○	○
○	○
○	○
○	○
○	○

Confezione / Box / Colis:
 M3 – M10: 10 pezzi / pcs
 M12 – M16: 5 pezzi / pcs

€ Pag. listino - Price list - Liste des prix

52

52

• Standard

○ Disponibilità da richiedere, prezzo a listino
 On enquiry, standard price-list / Stock à vérifier

★ Solo a richiesta
 Only on request / Sur demande

N USO GENERALE
General purpose - Usage Général

MASCHI A MACCHINA
MACHINE TAPS - TARAUDS MACHINE

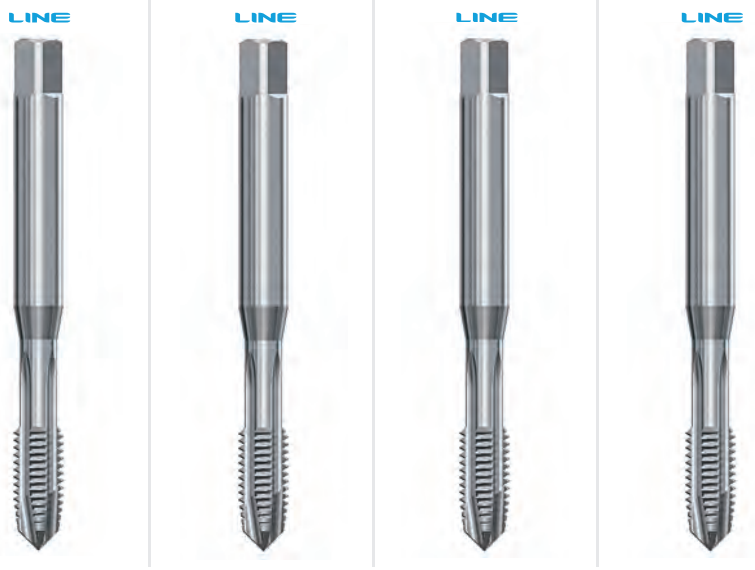
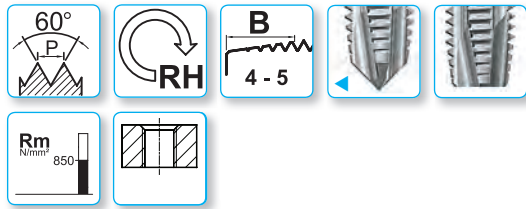
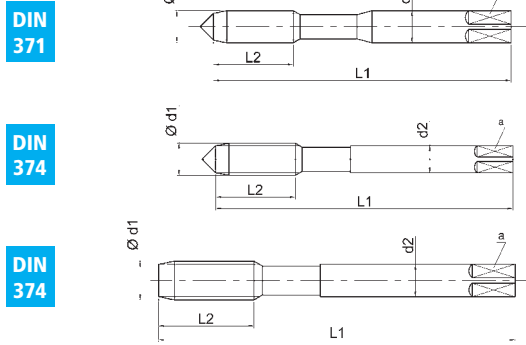

MF

Profond. di filettatura - Thread depth - Profond. de filetage	3xD	3xD	3xD	3xD
Materiale - Material - Matériau	HSSE	HSSE	HSSE	HSSE
Tolleranza - Tolerance - Tolérance	ISO1/4H	ISO3/6G	7G(6H+0,05)	6H+0,1
Trattamento superficiale - Surface treatment - Revêtement	BR	BR	BR	BR
Numero gruppi materiali Material's groups number Nombre de groupes du matériau	1.1 1.2 1.3 1.4 4.1 4.2 5.1 5.2	1.1 1.2 1.3 1.4 4.1 4.2 5.1 5.2	1.1 1.2 1.3 1.4 4.1 4.2 5.1 5.2	1.1 1.2 1.3 1.4 4.1 4.2 5.1 5.2

DIN 371	Ød1 MF	P mm	L1	L2	d2 h9	a h12	Z	
◀	8	1	90	18	8	6,2	3	7
◀	10	1	90	15	10	8	3	9
◀	10	1,25	100	20	10	8	3	8,75

CODICE - CODE			
E24MF...-4H	E24MF...-6G	E24MF...-7G	E24MF...+0,1
*	*	*	*
*	*	*	*
*	*	*	*

DIN 374	Ød1 MF	P mm	L1	L2	d2 h9	a h12	Z	
◀	8	1	90	18	6	4,9	3	7
◀	10	1	90	15	7	5,5	3	9
◀	10	1,25	100	20	7	5,5	3	8,75
	12	1,25	100	22	9	7	3	10,75
	12	1,5	100	22	9	7	3	10,5
	14	1,5	100	22	11	9	4	12,5
	16	1,5	100	22	12	9	4	14,5

CODICE - CODE			
E25MF...-4H	E25MF...-6G	E25MF...-7G	E25MF...+0,1
○	●	○	○
○	●	○	○
○	●	○	○
○	●	○	○
○	●	○	○
○	●	○	○
○	●	○	○

Confezione / Box / Colis: M3 – M10: 10 pezzi / pcs M12 – M16: 5 pezzi / pcs	€ Pag. listino - Price list - Liste des prix ● Standard	52	52	52	52
	○ Disponibilità da richiedere, prezzo a listino On enquiry, standard price-list / Stock à vérifier			★ Solo a richiesta Only on request / Sur demande	

MF

MASCHI A MACCHINA

MACHINE TAPS - TARAUDS MACHINE

Al-Cu-Fe
ALLUMINIO, RAME, ACCIAIO R ≤ 700 N/mm²
 Al, Cu, Steel R ≤ 700 N/mm² - Al, Cu, Acier R ≤ 700 N/mm²

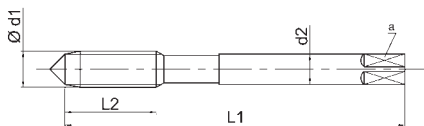
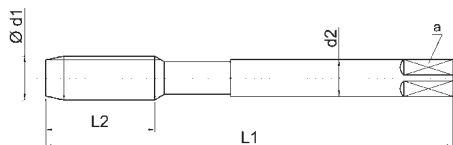
DIN 374

DIN 374

Profond. di filettatura - Thread depth - Profond. de filetage

Materiale - Material - Matériau

Tolleranza - Tolerance - Tolérance

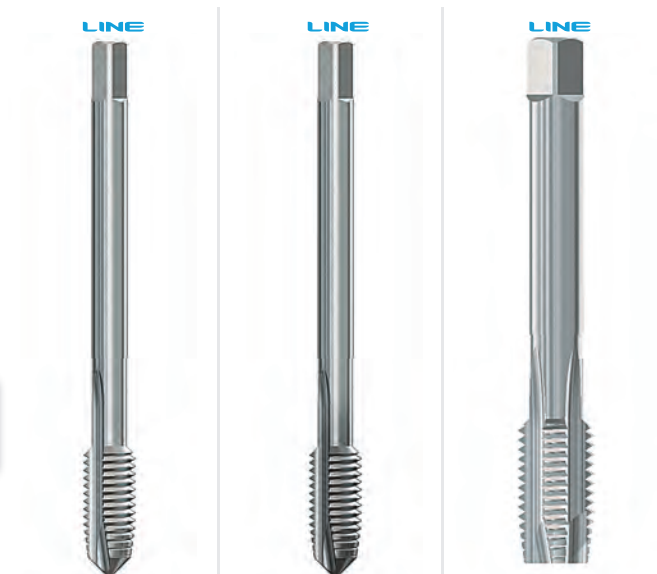
Trattamento superficiale - Surface treatment - Revêtement

 Numero gruppi materiali
Material's groups number
Nombre de groupes du matériau

3xD	3xD	3xD
HSSE	HSSE	HSSE
6H	6H	6H
BR	VS	CrN
1.1 4.1 4.2	1.1	1.1 1.2 1.3 1.4
5.1 5.2	4.1 4.2	5.1 5.2
6.1 7.1	5.1 5.2	
8.1	8.1	

DIN 374	Ød1 MF	P mm	L1	L2	d2 h9	a h12	Z	Icona
◀	6	0,75	80	16	4,5	3,4	2	5,25
◀	8	1	90	18	6	4,9	2	7
◀	10	1	90	15	7	5,5	2	9
◀	10	1,25	100	20	7	5,5	2	8,75
	12	1,25	100	22	9	7	3	10,75
	12	1,5	100	22	9	7	3	10,5
	14	1,5	100	22	11	9	3	12,5
	16	1,5	100	22	12	9	3	14,5
◀	6	0,75	80	16	4,5	3,4	3	5,25
◀	8	1	90	18	6	4,9	3	7
◀	10	1	90	15	7	5,5	3	9
◀	10	1,25	100	20	7	5,5	3	8,75
	12	1,25	100	22	9	7	3	10,75
	12	1,5	100	22	9	7	3	10,5
	14	1,5	100	22	11	9	4	12,5
	16	1,5	100	22	12	9	4	14,5
	18	1,5	110	25	14	11	4	16,5
	20	1,5	125	25	16	12	4	18,5
	22	1,5	125	25	18	14,5	4	20,5
	24	1,5	140	25	18	14,5	4	22,5
	24	2	140	25	18	14,5	4	22
	26	1,5	140	25	18	14,5	4	24,5

CODICE - CODE			
E25MF...AL	E25MF...AL-VS	E25MF...NC	
○	○		
○	○		
○	○		
○	○		
○	○		
○	○		
○	○		
○	○		
○	○		

N USO GENERALE R ≤ 1000N/mm²
General purpose R ≤ 1000N/mm² - Usage Général R ≤ 1000N/mm²

MASCHI A MACCHINA
MACHINE TAPS - TARAUDS MACHINE

DIN 374

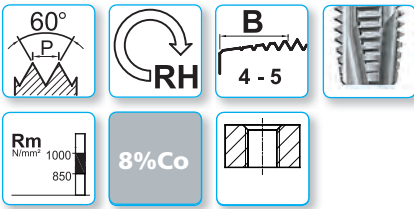
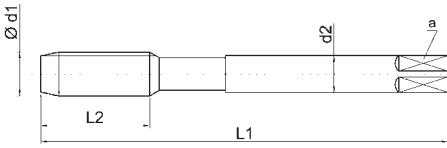

Profond. di filettatura - Thread depth - Profond. de filetage
Materiale - Material - Matériau
Tolleranza - Tolerance - Tolérance
Trattamento superficiale - Surface treatment - Revêtement

3xD	3xD	3xD	3xD
HSSP	HSSP	HSSP	HSSP
6H	6H	6H	6H
BR	V	TiN	TiCN
1.1 1.2 1.3 1.4	1.1 1.2 1.3 1.4	1.1 1.2 1.3 1.4 1.5	1.1 1.2 1.3 1.4 1.5
4.1 4.2	4.1 4.2	3.3 3.4 4.1 4.2 4.3	2.1 2.2
5.1 5.2	5.1 5.2	5.1 5.2	3.3 3.4 4.2 4.3
	6.1 7.1		5.2

Numero gruppi materiali
Material's groups number
Nombre de groupes du matériau

DIN 374	Ød1 MF	P mm	L1	L2	d2 h9	a h12	Z	
	8	1	90	18	6	4,9	3	7
	10	1	90	15	7	5,5	3	9
	10	1,25	100	20	7	5,5	3	8,75
	12	1,25	100	22	9	7	4	10,75
	12	1,5	100	22	9	7	4	10,5
	14	1,5	100	22	11	9	4	12,5
	16	1,5	100	22	12	9	4	14,5
	18	1,5	110	25	14	11	4	16,5
	20	1,5	125	25	16	12	4	18,5

P25MF...	CODICE - CODE		
	P25MF...V	P25MF...T	P25MF...CT
○	○	○	○
○	○	○	○
○	○	○	○
○	○	○	○
○	○	○	○
*	*	*	*
*	*	*	*
*	*	*	*
*	*	*	*

★ Solo a richiesta
Only on request / Sur demande

MF Filettatura metrica ISO passo fine DIN 13 ISO metric fine thread DIN13

Metrisches ISO-Feingewinde DIN 13 – Maschinengewindebohrer
Filetage métrique ISO à pas fin DIN 13 – Tarauds machine
Rosca ISO métrica fina DIN 13 – Machos de rosca a máquina



U

APPLICAZIONI UNIVERSALI R ≤ 1200 N/mm²
Universal R ≤ 1200 N/mm² - Universal R ≤ 1200 N/mm²

MASCHI A MACCHINA

MACHINE TAPS - TARAUDS MACHINE

DIN 374

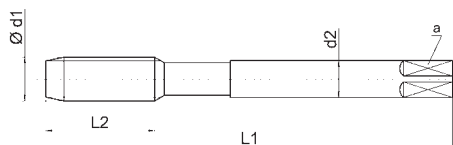

TOP



TOP



Profond. di filettatura - Thread depth - Profond. de filetage

Materiale - Material - Matériau

Tolleranza - Tolerance - Tolérance

Trattamento superficiale - Surface treatment - Revêtement

3xD

3,5xD

PM3

PM3

6HX

6HX

XP

XP

1.1 1.2 1.3 1.4 1.5

1.1 1.2 1.3 1.4 1.5

2.1 2.2 2.3

2.1 2.2 2.3

3.3 3.4 4.2 4.3

3.3 3.4 4.2 4.3

5.2

5.2

Numero gruppi materiali
Material's groups number
Nombre de groupes du matériau

DIN 374	Ød1 MF	P mm	L ₁	L ₂	d ₂ h9	a h12	Z	
8	1	90	18	6	4,9	3	7	
10	1	90	15	7	5,5	3	9	
10	1,25	100	20	7	5,5	3	8,75	
12	1,25	100	22	9	7	4	10,75	
12	1,5	100	22	9	7	4	10,5	
14	1,5	100	22	11	9	4	12,5	
16	1,5	100	22	12	9	4	14,5	
18	1,5	110	25	14	11	4	16,5	
20	1,5	125	25	16	12	4	18,5	
new 22	1,5	125	25	18	14,5	4	20,5	
new 24	1,5	140	25	18	14,5	4	22,5	

CODICE - CODE			
K25MF...XP	K25MF...FORY-XP		
○	○		
○	○		
○	○		
○	○		
○	○		
○	○		
○	○		
○	○		
○	○		
○	○		
○	○		
○	○		
○	○		
○	○		
○	○		
○	○		
○	○		
○	○		
○	○		
○	○		
○	○		
○	○		

Confezione / Box / Colis:
M3 - M10: 10 pezzi / pcs
M12 - M16: 5 pezzi / pcs

€ Pag. listino - Price list - Liste des prix

53

54

● Standard

○ Disponibilità da richiedere, prezzo a listino
On enquiry, standard price-list / Stock à vérifier

★ Solo a richiesta
Only on request / Sur demande

SYNCHRO RIGID

MASCHIATURA RIGIDA SINCRONIZZATA

Rigid Tapping Synchro - Taraudage rigide synchronisé

MASCHI A MACCHINA

MACHINE TAPS - TARAUDS MACHINE

UFS norm

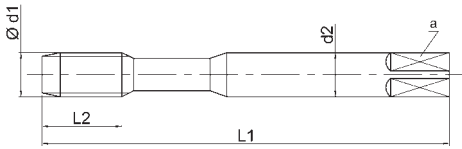

-
-
-
-
-
-
-

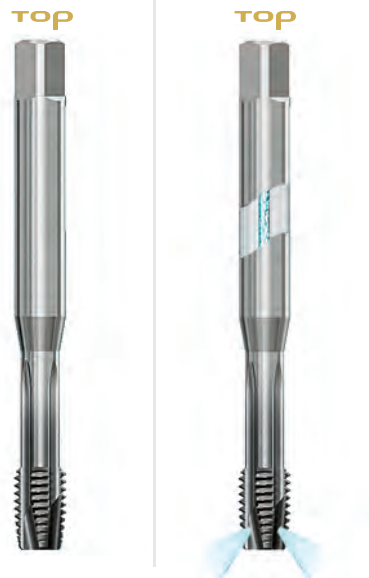

Profond. di filettatura - Thread depth - Profond. de filetage
 Materiale - Material - Matériau
 Tolleranza - Tolerance - Tolérance
 Trattamento superficiale - Surface treatment - Revêtement

3xD **3,5xD**
PM3 **PM3**
6HX **6HX**
TXC **TXC**

Numero gruppi materiali
 Material's groups number
 Nombre de groupes du matériau

1.1	1.2	1.3	1.4	1.5	1.1	1.2	1.3	1.4	1.5		
2.1	2.2	2.3	2.4	3.3	3.4	2.1	2.2	2.3	2.4	3.3	3.4
4.1	4.2	4.3	4.5	4.6	5.1	4.1	4.2	4.3	4.5	4.6	5.1
5.2	5.3	6.1	6.2	7.1	7.2	5.2	5.3	6.1	6.2	7.1	7.2

UFS norm	Ød1 MF	P mm	L1	L2	d2 h6	a h12	Z		CODICE - CODE	
									S24MF...TXC	S24MF...FORY-TXC
	8	1	90	13	8	6,2	3	7	<input type="radio"/>	<input type="radio"/>
	10	1	100	15	10	8	3	9	<input type="radio"/>	<input type="radio"/>
	10	1,25	100	15	10	8	3	8,75	<input type="radio"/>	<input type="radio"/>
	12	1,25	110	18	12	9	3	10,75	<input type="radio"/>	<input type="radio"/>
	12	1,5	110	18	12	9	3	10,5	<input type="radio"/>	<input type="radio"/>
	14	1,5	110	20	12	9	3	12,5	<input type="radio"/>	<input type="radio"/>
	16	1,5	110	20	16	12	4	14,5	<input type="radio"/>	<input type="radio"/>

MF Filettatura metrica ISO passo fine DIN 13

ISO metric fine thread DIN13

Metrisches ISO-Feingewinde DIN 13 – Maschinengewindebohrer
 Filetage métrique ISO à pas fin DIN 13 – Tarauds machine
 Rosca ISO métrica fina DIN 13 – Machos de rosca a máquina



HR

ALTA RESISTENZA
 High Resistance - Haute Résistance

MASCHI A MACCHINA

MACHINE TAPS - TARAUDS MACHINE

MF

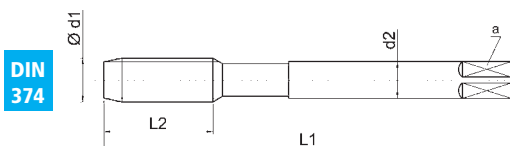

DIN 374

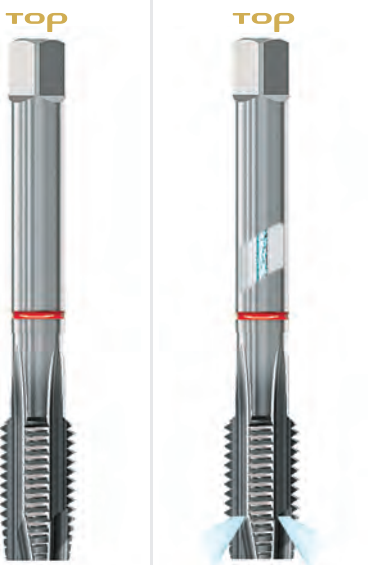
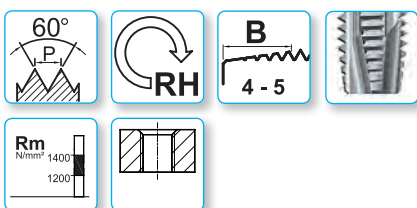

Profond. di filettatura - Thread depth - Profond. de filetage

Materiale - Material - Matériau

Tolleranza - Tolerance - Tolérance

Trattamento superficiale - Surface treatment - Revêtement

Numero gruppi materiali
 Material's groups number
 Nombre de groupes du matériau

3xD	3,5xD
PM3	PM3
6HX	6HX
TXC	TXC
1.5 1.6	1.5 1.6
3.3 3.4	3.3 3.4
4.4 5.3	4.4 5.3

DIN 374	ød1 MF	P mm	L ₁	L ₂	d ₂ h9	a h12	Z	
8	1	90	18	6	4,9	3	7	
10	1	90	15	7	5,5	3	9	
10	1,25	100	20	7	5,5	3	8,75	
12	1,25	100	22	9	7	4	10,75	
12	1,5	100	22	9	7	4	10,5	
14	1,5	100	22	11	9	4	12,5	
16	1,5	100	22	12	9	4	14,5	

CODICE - CODE	
K25MF...TXC	K25MF...FORY-TXC
○	○
○	○
○	○
○	○
○	○
○	○
○	○
○	○
○	○
○	○
○	○
○	○
○	○
○	○
○	○
○	○
○	○
○	○
○	○
○	○
○	○

MASCHI A MACCHINA
 MACHINE TAPS - TARAUDS MACHINE

MF

DIN 374

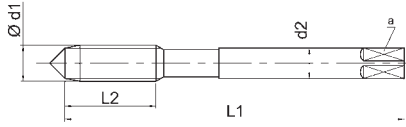

DIN 374

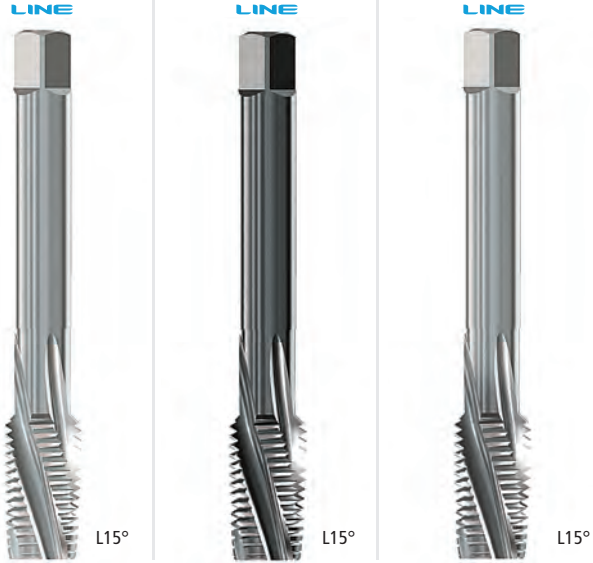
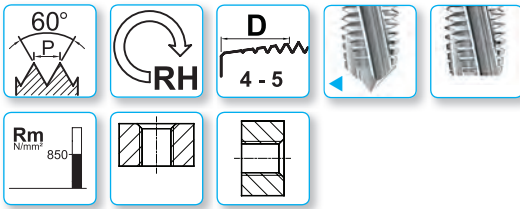
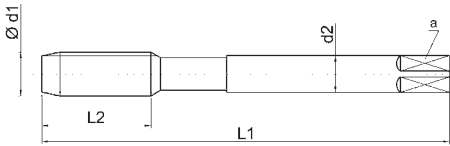

Profond. di filettatura - Thread depth - Profond. de filetage

Materiale - Material - Matériau

Tolleranza - Tolerance - Tolérance

Trattamento superficiale - Surface treatment - Revêtement

Numero gruppi materiali
 Material's groups number
 Nombre de groupes du matériau

3xD	3xD	3xD
HSSE	HSSE	HSSE
ISO2/6H	ISO2/6H	ISO2/6H
BR	V	XP
1.1 1.2 1.3 1.4	1.1 1.2 1.3 1.4	1.1 1.2 1.3 1.4
	4.2 5.2	3.3 3.4
	6.1 7.1	4.3 5.2

DIN 374	Ød1 MF	P mm	L1	L2	d2 h9	a h12	Z	
◀	6	0,75	80	16	4,5	3,4	3	5,25
◀	8	1	90	18	6	4,9	3	7
◀	10	1	90	15	7	5,5	3	9
◀	10	1,25	100	20	7	5,5	3	8,75
	12	1	100	22	9	7	3	11
	12	1,25	100	22	9	7	3	10,75
	12	1,5	100	22	9	7	3	10,5
	14	1	100	22	11	9	3	13
	14	1,25	100	22	11	9	3	12,75
	14	1,5	100	22	11	9	3	12,5
	16	1	100	22	12	9	3	15
	16	1,25	100	22	12	9	3	14,75
	16	1,5	100	22	12	9	3	14,5
	18	1,5	110	25	14	11	4	16,5
	20	1	125	25	16	12	4	19
	20	1,5	125	25	16	12	4	18,5
	22	1,5	125	25	18	14,5	4	20,5
	24	1,5	140	25	18	14,5	4	22,5
	24	2	140	25	18	14,5	4	22
	26	1,5	140	25	18	14,5	4	24,5
	27	2	140	25	20	16	4	25
	30	1,5	150	28	22	18	4	28,5
	30	2	150	28	22	18	4	28

E51MF...	CODICE - CODE	
	E51MF...V	E51MF...XP
○	○	○
●	○	○
○	○	○
●	○	○
○	○	○
●	○	○
○	○	○
○	○	○
●	○	○
○	○	○
○	○	○
○	○	○
○	○	○
○	○	○
○	○	○
○	○	○
○	○	○
○	○	○
○	○	○
○	○	○
○	○	○
○	○	○
○	○	○
○	○	○

Da usare in alternativa ai maschi con imbocco corretto per fori profondi specialmente in filettatura orizzontale.
 To be used with deep holes, specially in horizontal threading.
 À utiliser en alternative aux tarauds entrée GUN pour trous profonds.
 Particulièrement pour les taraudages horizontaux.

Ti

TITANIO

Titanium - Titane

MASCHI A MACCHINA

MACHINE TAPS - TARAUDS MACHINE

DIN 371

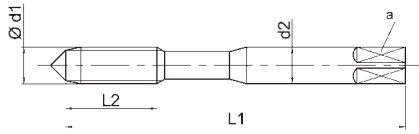

DIN 374

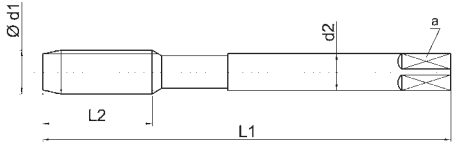

top



L15°

top



L15°

top



L15°



Profond. di filettatura - Thread depth - Profond. de filetage

Materiale - Material - Matériau

Tolleranza - Tolerance - Tolérance

Trattamento superficiale - Surface treatment - Revêtement

Numero gruppi materiali

Material's groups number

Nombre de groupes du matériau

3xD	3xD	3xD
PM3	PM3	PM3
6HX	6HX	4H
V	TiCN	V
6.1	1.6 2.4	6.1
	3.3 3.4	
	4.4 5.3 5.4 6.2 6.3	
	7.2 9.2	

DIN 371	Ød1 MF	P mm	L1	L2	d2 h9	a h12	Z	
◀	8	1	90	18	8	6,2	3	*7
◀	10	1	100	20	10	8	3	*9
◀	10	1,25	100	20	10	8	3	*8,75

CODICE - CODE		
K52MF...V	K52MF...CT	*K52MJF...V
<input type="radio"/>	<input type="radio"/>	<input type="radio"/>
<input type="radio"/>	<input type="radio"/>	<input type="radio"/>
<input type="radio"/>	<input type="radio"/>	<input type="radio"/>

DIN 374	Ød1 MF	P mm	L1	L2	d2 h9	a h12	Z	
	12	1,25	100	22	9	7	3	*10,75
	12	1,5	100	22	9	7	3	*10,5
	14	1,5	100	22	11	9	3	*12,5
	16	1,5	100	22	12	9	3	*14,5

CODICE - CODE		
K53MF...V	K53MF...CT	*K53MJF...V
<input type="radio"/>	<input type="radio"/>	<input type="radio"/>
<input type="radio"/>	<input type="radio"/>	<input type="radio"/>
<input type="radio"/>	<input type="radio"/>	<input type="radio"/>
<input type="radio"/>	<input type="radio"/>	<input type="radio"/>

* Per MJ vedi tabella di foratura pag. 252
 * Drills' diameters for MJ: table page 252
 * Pour MJ voir le tableau de perçage page 252

* Rivestimento TiCN a richiesta
 * TiCN coating on request
 * Revêtement TiCN sur demande

Confezione / Box / Colis: M3 – M10: 10 pezzi / pcs M12 – M16: 5 pezzi / pcs	€ Pag. listino - Price list - Liste des prix	55	56	56
● Standard	○ Disponibilità da richiedere, prezzo a listino On enquiry, standard price-list / Stock à vérifier			★ Solo a richiesta Only on request / Sur demande

MF Filettatura metrica ISO passo fine DIN 13

ISO metric fine thread DIN13

Metrisches ISO-Feingewinde DIN 13 – Maschinengewindebohrer
 Filetage métrique ISO à pas fin DIN 13 – Tarauds machine
 Rosca ISO métrica fina DIN 13 – Machos de roscar a máquina



Ni

NICHEL
Nickel - Nickel

MASCHI A MACCHINA

MACHINE TAPS - TARAUDS MACHINE

MF

UFS norm

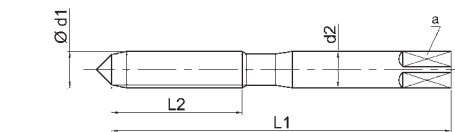

UFS norm

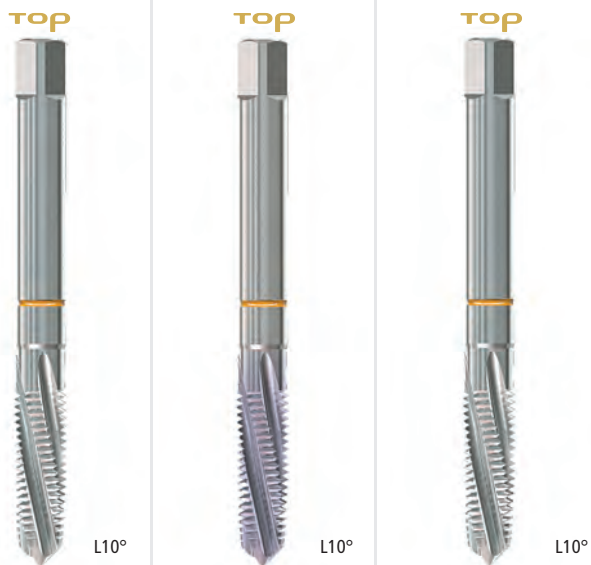
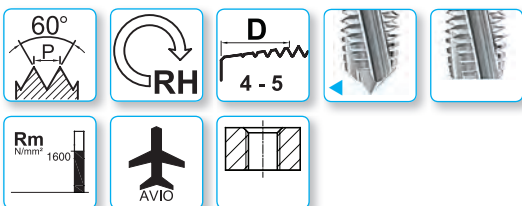
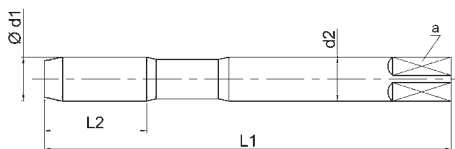

Profond. di filettatura - Thread depth - Profond. de filetage

Materiale - Material - Matériau

Tolleranza - Tolerance - Tolérance

Trattamento superficiale - Surface treatment - Revêtement

Numero gruppi materiali
Material's groups number
Nombre de groupes du matériau

3xD	3xD	3xD
PM3	PM3	PM3
6HX	6HX	4HX
BR	TiCN	BR
7.3 9.3	1.6 5.4	7.3 9.3
	7.2 9.1	

UFS norm	Ød1 MF	P mm	L1	L2	d2 h9	a h12	Z	
◀	8	1	90	25	8	6,2	3	*7
◀	10	1	100	30	10	8	3	*9
◀	10	1,25	100	30	10	8	3	*8,75
	12	1,25	110	30	12	9	3	*10,75
	12	1,5	110	30	12	9	3	*10,5
	14	1,5	110	30	12	9	3	*12,5
	16	1,5	110	30	16	12	3	*12,5

CODICE - CODE		
K52MF...NI	K52MF...NI-CT	K52MF...NI-4HX
○	○	★
○	○	★
○	○	★
○	○	★
○	○	★
○	○	★
○	○	★

* Per MJ vedi tabella di foratura pag. 252
 * Drills' diameters for MJ: table page 252
 * Pour MJ voir le tableau de perçage page 252

Confezione / Box / Colis: M3 – M10: 10 pezzi / pcs M12 – M16: 5 pezzi / pcs	€ Pag. listino - Price list - Liste des prix ● Standard	56 ○ Disponibilità da richiedere, prezzo a listino On enquiry, standard price-list / Stock à vérifier	56 ★ Solo a richiesta Only on request / Sur demande
---	--	---	---

N USO GENERALE
General purpose - Usage Général

MASCHI A MACCHINA
MACHINE TAPS - TARAUDS MACHINE

DIN 371

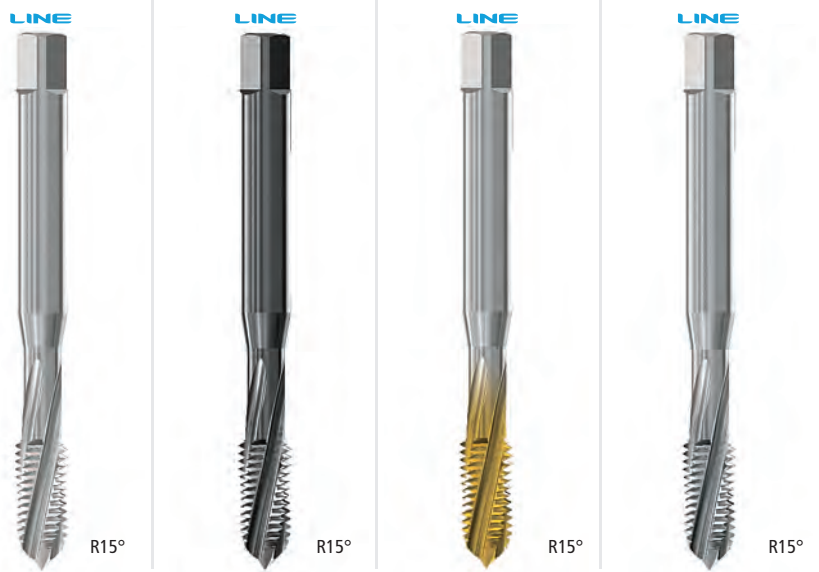
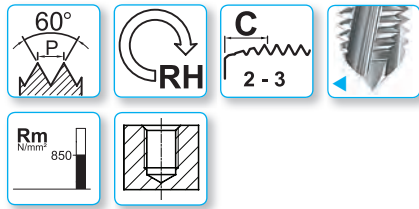
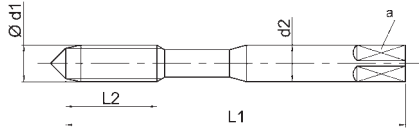

Profond. di filettatura - Thread depth - Profond. de filetage
 Materiale - Material - Matériau
 Tolleranza - Tolerance - Tolérance
 Trattamento superficiale - Surface treatment - Revêtement

1,5xD	1,5xD	1,5xD	1,5xD
HSSE	HSSE	HSSE	HSSE
ISO2/6H	ISO2/6H	ISO2/6H	ISO2/6H
BR	V	TiN	XP
1.1 1.2 1.3 1.4	1.1 1.2 1.3 1.4	1.1 1.2 1.3 1.4	1.1 1.2 1.3 1.4
4.1 4.2	4.1 4.2	3.3 3.4	3.3 3.4
5.1 5.2	5.1 5.2	4.1 4.2 4.3	4.2 4.3
	6.1 7.1	5.1 5.2	5.2

Numero gruppi materiali
Material's groups number
Nombre de groupes du matériau

DIN 371	Ød1 MF	P mm	L ₁	L ₂	d ₂ h9	a h12	Z	
◀	4	0,5	63	13	4,5	3,4	3	3,5
◀	5	0,5	70	13	6	4,9	3	4,5
◀	6	0,75	80	16	6	4,9	3	5,25
◀	8	0,75	90	18	8	6,2	3	7,25
◀	8	1	90	18	8	6,2	3	7
◀	10	1	90	15	10	8	3	9
◀	10	1,25	100	20	10	8	3	8,75

E40MF...	CODICE - CODE		
	E40MF...V	E40MF...T	E40MF...XP
○	○	○	○
○	○	○	○
●	○	○	○
○	○	○	○
●	○	○	○
○	○	○	○
●	○	○	○

Segue diametri
Diameters, to be continued
Diamètres à suivre

▶ Pag. 116

MF Filettatura metrica ISO passo fine DIN 13

ISO metric fine thread DIN13

Metrisches ISO-Feingewinde DIN 13 – Maschinengewindebohrer
Filetage métrique ISO à pas fin DIN 13 – Tarauds machine
Rosca ISO métrica fina DIN 13 – Machos de roscar a máquina



N **USO GENERALE**
General purpose - Usage Général

MASCHI A MACCHINA

MACHINE TAPS - TARAUDS MACHINE

DIN 374

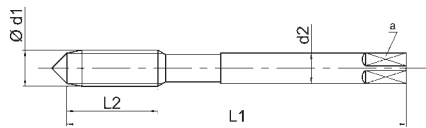

DIN 374

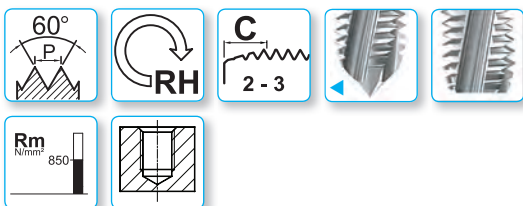
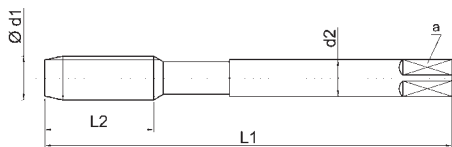

LINE



R15°

LINE



R15°

LINE



R15°

LINE



R15°

Profond. di filettatura - Thread depth - Profond. de filetage

Materiale - Material - Matériau

Tolleranza - Tolerance - Tolérance

Trattamento superficiale - Surface treatment - Revêtement

Numero gruppi materiali
Material's groups number
Nombre de groupes du matériau

1,5xD	1,5xD	1,5xD	1,5xD
HSSE	HSSE	HSSE	HSSE
ISO2/6H	ISO2/6H	ISO2/6H	ISO2/6H
BR	V	TiN	XP
1.1 1.2 1.3 1.4	1.1 1.2 1.3 1.4	1.1 1.2 1.3 1.4	1.1 1.2 1.3 1.4
4.1 4.2	4.1 4.2	3.3 3.4	3.3 3.4
5.1 5.2	5.1 5.2	4.1 4.2 4.3	4.2 4.3
	6.1 7.1	5.1 5.2	5.2

DIN 374	$\varnothing d1$	P	L ₁	L ₂	d ₂	a	Z	
MF	mm	mm	mm	mm	h9	h12		
6	0,75	80	16	4,5	3,4	3	5,25	
8	0,75	90	18	6	4,9	3	7,25	
8	1	90	18	6	4,9	3	7	
9	1	90	18	7	5,5	3	8	
10	0,75	90	15	7	5,5	3	9,15	
10	1	90	15	7	5,5	3	9	
10	1,25	100	20	7	5,5	3	8,75	
11	1	100	20	8	6,2	3	10	
11	1,25	100	20	8	6,2	3	9,75	
12	1	100	22	9	7	3	11	
12	1,25	100	22	9	7	3	10,75	
12	1,5	100	22	9	7	3	10,5	
14	1	100	22	11	9	3	13	
14	1,25	100	22	11	9	3	12,75	
14	1,5	100	22	11	9	3	12,5	
15	1	100	22	12	9	3	14	
15	1,5	100	22	12	9	3	13,5	
16	1	100	22	12	9	3	15	
16	1,25	100	22	12	9	3	14,75	
16	1,5	100	22	12	9	3	14,5	
17	1	110	25	14	11	4	16	
17	1,5	110	25	14	11	4	15,5	
18	1	110	25	14	11	4	17	
18	1,5	110	25	14	11	4	16,5	
19	1	125	25	16	12	4	19	
19	1,5	125	25	16	12	4	18,5	

E41MF...	CODICE - CODE			E41MF...XP
	E41MF...V	E41MF...T		
<input type="radio"/>	<input type="radio"/>	<input type="radio"/>	<input type="radio"/>	
<input type="radio"/>	<input type="radio"/>	<input type="radio"/>	<input type="radio"/>	
<input checked="" type="radio"/>	<input checked="" type="radio"/>	<input type="radio"/>	<input type="radio"/>	
<input type="radio"/>	<input type="radio"/>	<input type="radio"/>	<input checked="" type="radio"/>	
<input type="radio"/>	<input type="radio"/>	<input type="radio"/>	<input checked="" type="radio"/>	
<input checked="" type="radio"/>	<input checked="" type="radio"/>	<input type="radio"/>	<input type="radio"/>	
<input type="radio"/>	<input type="radio"/>	<input type="radio"/>	<input checked="" type="radio"/>	
<input checked="" type="radio"/>	<input checked="" type="radio"/>	<input checked="" type="radio"/>	<input checked="" type="radio"/>	
<input checked="" type="radio"/>	<input checked="" type="radio"/>	<input type="radio"/>	<input checked="" type="radio"/>	
<input checked="" type="radio"/>	<input checked="" type="radio"/>	<input type="radio"/>	<input checked="" type="radio"/>	
<input type="radio"/>	<input type="radio"/>	<input type="radio"/>	<input checked="" type="radio"/>	
<input type="radio"/>	<input type="radio"/>	<input type="radio"/>	<input checked="" type="radio"/>	
<input checked="" type="radio"/>	<input checked="" type="radio"/>	<input type="radio"/>	<input type="radio"/>	
<input type="radio"/>	<input type="radio"/>	<input type="radio"/>	<input checked="" type="radio"/>	
<input type="radio"/>	<input type="radio"/>	<input type="radio"/>	<input checked="" type="radio"/>	
<input checked="" type="radio"/>	<input type="radio"/>	<input type="radio"/>	<input type="radio"/>	
<input type="radio"/>	<input type="radio"/>	<input type="radio"/>	<input checked="" type="radio"/>	
<input type="radio"/>	<input type="radio"/>	<input type="radio"/>	<input checked="" type="radio"/>	

Segue diametri
Diameters, to be continued
Diamètres à suivre

▶ Pag. 117

N **USO GENERALE**
General purpose - Usage Général

MASCHI A MACCHINA
MACHINE TAPS - TARAUDS MACHINE

DIN 374

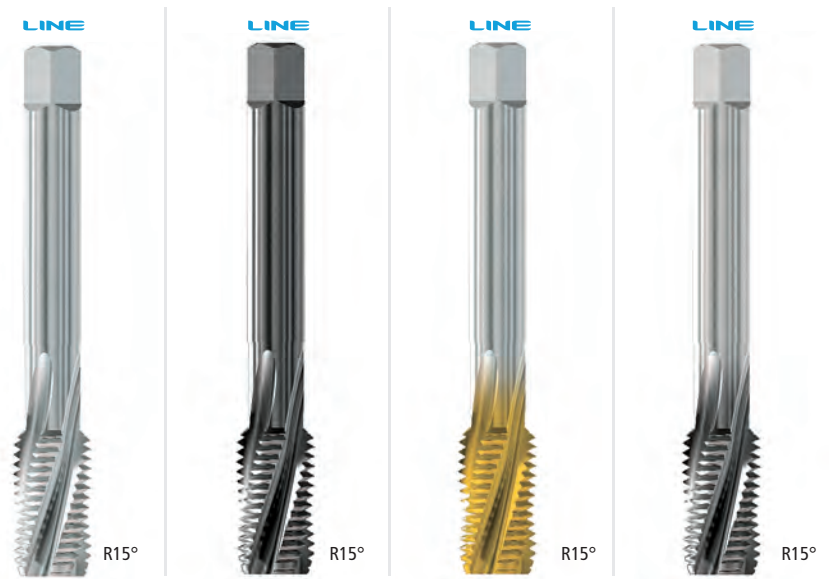
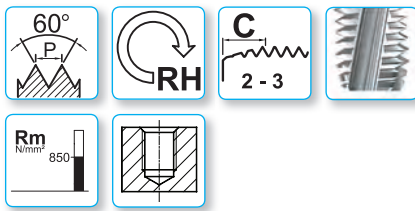
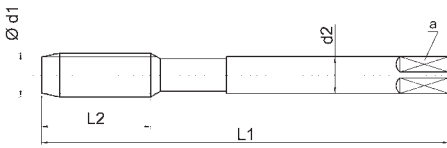

Profond. di filettatura - Thread depth - Profond. de filetage

Materiale - Material - Matériau

Tolleranza - Tolerance - Tolérance

Trattamento superficiale - Surface treatment - Revêtement

1,5xD	1,5xD	1,5xD	1,5xD
HSSE	HSSE	HSSE	HSSE
ISO2/6H	ISO2/6H	ISO2/6H	ISO2/6H
BR	V	TiN	XP
1.1 1.2 1.3 1.4	1.1 1.2 1.3 1.4	1.1 1.2 1.3 1.4	1.1 1.2 1.3 1.4
4.1 4.2	4.1 4.2	3.3 3.4	3.3 3.4
5.1 5.2	5.1 5.2	4.1 4.2 4.3	4.2 4.3
	6.1 7.1	5.1 5.2	5.2

Numero gruppi materiali
Material's groups number
Nombre de groupes du matériau

DIN 374	Ød1 MF	P mm	L ₁	L ₂	d ₂ h9	a h12	Z	🌀
	20	1	125	25	16	12	4	19
	20	1,5	125	25	16	12	4	18,5
	20	2	140	33	16	12	4	18
	22	1	125	25	18	14,5	4	21
	22	1,5	125	25	18	14,5	4	20,5
	22	2	140	33	18	14,5	4	20
	24	1	140	25	18	14,5	4	23
	24	1,5	140	25	18	14,5	4	22,5
	24	2	140	25	18	14,5	4	22
	25	1	140	25	18	14,5	4	24
	25	1,5	140	25	18	14,5	4	23,5
	25	2	140	25	18	14,5	4	23
	26	1	140	25	18	14,5	4	25
	26	1,5	140	25	18	14,5	4	24,5
	26	2	140	25	18	14,5	4	24
	27	1	140	25	20	16	4	26
	27	1,5	140	25	20	16	4	25,5
	27	2	140	25	20	16	4	25
	28	1	140	25	20	16	4	27
	28	1,5	140	25	20	16	4	26,5
	28	2	140	25	20	16	4	26
	30	1	150	28	22	18	4	29
	30	1,5	150	28	22	18	4	28,5
	30	2	150	28	22	18	4	28
	30	3	180	46	22	18	4	27

E41MF...	CODICE - CODE		
	E41MF...V	E41MF...T	E41MF...XP
○	○	○	○
●	○	○	○
○	○	○	○
○	○	○	○
●	○	○	○
○	○	○	○
○	○	○	○
○	○	○	○
○	○	○	○
○	○	○	○
○	○	○	○
○	○	○	○
○	○	○	○
○	○	○	○
○	○	○	○
○	○	○	○
○	○	○	○
○	○	○	○
○	○	○	○
○	○	○	○
○	○	○	○
○	○	○	○

Confezione / Box / Colis: M3 – M10: 10 pezzi / pcs M12 – M16: 5 pezzi / pcs	€ Pag. listino - Price list - Liste des prix ● Standard	57 ○ Disponibilità da richiedere, prezzo a listino On enquiry, standard price-list / Stock à vérifier	57 ● Solo a richiesta Only on request / Sur demande	57	58
---	--	--	--	-----------	-----------

MF Filettatura metrica ISO passo fine DIN 13

ISO metric fine thread DIN13

Metrisches ISO-Feingewinde DIN 13 – Maschinengewindebohrer
 Filetage métrique ISO à pas fin DIN 13 – Tarauds machine
 Rosca ISO métrica fina DIN 13 – Machos de roscar a máquina



N

USO GENERALE
 General purpose - Usage Général

MASCHI A MACCHINA

MACHINE TAPS - TARAUDS MACHINE

MF

DIN 371

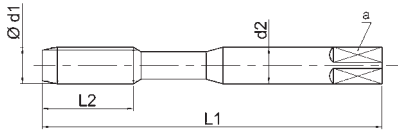

DIN 374

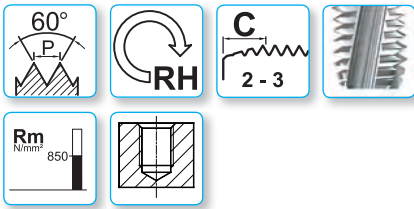
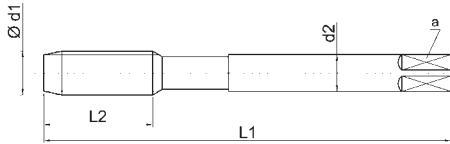

LINE



R15°

LINE



R15°

Profond. di filettatura - Thread depth - Profond. de filetage

Materiale - Material - Matériau

Tolleranza - Tolerance - Tolérance

Trattamento superficiale - Surface treatment - Revêtement

Numero gruppi materiali
 Material's groups number
 Nombre de groupes du matériau

2,5xD

HSSE

ISO2/6H

BR

1.1 1.2 1.3 1.4

4.1 4.2

5.1 5.2

2,5xD

HSSE

ISO2/6H

TiN

1.1 1.2 1.3 1.4

3.3 3.4

4.1 4.2 4.3

5.1 5.2

DIN 371	Ød1 MF	P mm	L1	L2	d2 h9	a h12	Z	
8	1	90	18	8	6,2	3	7	
10	1	90	15	10	8	3	9	
10	1,25	100	20	10	8	3	8,75	

CODICE - CODE	
E40MF...FOR	E40MF...FOR-T
<input type="radio"/>	<input type="radio"/>
<input type="radio"/>	<input type="radio"/>
<input type="radio"/>	<input type="radio"/>

DIN 374	Ød1 MF	P mm	L1	L2	d2 h9	a h12	Z	
12	1,25	100	22	9	7	3	10,75	
12	1,5	100	22	9	7	3	10,5	
14	1,5	100	22	11	9	3	12,5	
16	1,5	100	22	12	9	3	14,5	

CODICE - CODE	
E41MF...FOR	E41MF...FOR-T
<input type="radio"/>	<input type="radio"/>
<input type="radio"/>	<input type="radio"/>
<input type="radio"/>	<input type="radio"/>
<input type="radio"/>	<input type="radio"/>

Confezione / Box / Colis:
 M3 – M10: 10 pezzi / pcs
 M12 – M16: 5 pezzi / pcs

€ Pag. listino - Price list - Liste des prix

58

58

• Standard

○ Disponibilità da richiedere, prezzo a listino
 On enquiry, standard price-list / Stock à vérifier

★ Solo a richiesta
 Only on request / Sur demande

N
USO GENERALE R ≤ 1000N/mm²

General purpose R ≤ 1000N/mm² - Usage Général R ≤ 1000N/mm²

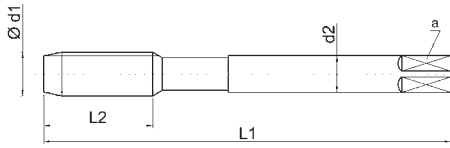
MASCHI A MACCHINA
MACHINE TAPS - TARAUDS MACHINE
DIN 374

Profond. di filettatura - Thread depth - Profond. de filetage

Materiale - Material - Matériau

Tolleranza - Tolerance - Tolérance

Trattamento superficiale - Surface treatment - Revêtement

Numero gruppi materiali

Material's groups number

Nombre de groupes du matériau

DIN 374	Ød1	P	L ₁	L ₂	d ₂	a	Z	
MF	mm	mm	mm	mm	h ₉	h ₁₂		
8	1	90	18	6	4,9	3	7	
10	1	90	15	7	5,5	3	9	
10	1,25	100	20	7	5,5	3	8,75	
12	1,25	100	22	9	7	4	10,75	
12	1,5	100	22	9	7	4	10,5	
14	1,5	100	22	11	9	4	12,5	
16	1,5	100	22	12	9	4	14,5	
18	1,5	110	25	14	11	4	16,5	
20	1,5	125	25	16	12	4	18,5	

1,5xD	1,5xD	1,5xD	1,5xD
HSSP	HSSP	HSSP	HSSP
ISO2/6H	ISO2/6H	ISO2/6H	ISO2/6H
BR	V	TiN	TiCN
1.1 1.2 1.3 1.4	1.1 1.2 1.3 1.4	1.1 1.2 1.3 1.4 1.5	1.1 1.2 1.3 1.4 1.5
4.1 4.2	4.1 4.2	3.3 3.4 4.1 4.2 4.3	3.3 3.4 4.2 4.3
5.1 5.2	5.1 5.2	5.1 5.2	5.2
	6.1 7.1		

DIN 374	CODICE - CODE			
	P41MF...	P41MF... V	P41MF... T	P41MF... CT
8	○	○	○	○
10	○	○	○	○
10	○	○	○	○
12	○	○	○	○
12	○	○	○	○
14	○	○	○	○
16	○	○	○	○
18	○	○	○	○
20	○	○	○	○

***** Ad esaurimento scorte
Stock clearance - Stock épuisé

Confezione / Box / Colis:	€ Pag. listino - Price list - Liste des prix	58	58	58	58
M3 – M10: 10 pezzi / pcs M12 – M16: 5 pezzi / pcs	● Standard	○ Disponibilità da richiedere, prezzo a listino On enquiry, standard price-list / Stock à vérifier		★ Solo a richiesta Only on request / Sur demande	

MF Filettatura metrica ISO passo fine DIN 13

ISO metric fine thread DIN13

Metrisches ISO-Feingewinde DIN 13 – Maschinengewindebohrer
 Filetage métrique ISO à pas fin DIN 13 – Tarauds machine
 Rosca ISO métrica fina DIN 13 – Machos de roscar a máquina



Ti

TITANIO
Titanium - Titane

MASCHI A MACCHINA

MACHINE TAPS - TARAUDS MACHINE

MF

DIN 371

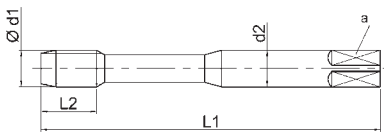

DIN 374

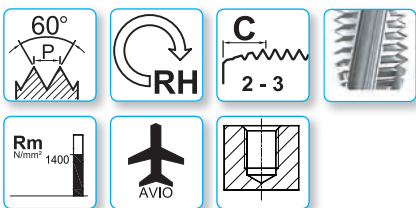
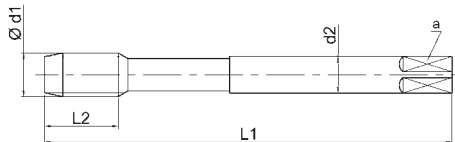

top



R15°

top



R15°

top



R15°

Profond. di filettatura - Thread depth - Profond. de filetage

Materiale - Material - Matériau

Tolleranza - Tolerance - Tolérance

Trattamento superficiale - Surface treatment - Revêtement

Numero gruppi materiali

Material's groups number

Nombre de groupes du matériau

1,5xD

PM3

6HX

V

6.1

1,5xD

PM3

6HX

TiCN

1.6 2.4

3.3 3.4

4.4 5.3 5.4 6.2 6.3

7.2 9.2

1,5xD

PM3

4H

V

6.1

DIN	Ød1	P	L1	L2	d2	a	Z	
371	MF	mm			h9	h12		
	8	1	90	13	8	6,2	3	*7
	10	1	100	15	10	8	3	*9
	10	1,25	100	15	10	8	3	*8,75

CODICE - CODE		
K42MF...V	K42MF...CT	*K42MJF...V
<input type="checkbox"/>	<input type="checkbox"/>	<input type="checkbox"/>
<input type="checkbox"/>	<input type="checkbox"/>	<input type="checkbox"/>
<input type="checkbox"/>	<input type="checkbox"/>	<input type="checkbox"/>

DIN	Ød1	P	L1	L2	d2	a	Z	
374	MF	mm			h9	h12		
	12	1,25	100	13	9	7	4	*10,75
	12	1,5	100	13	9	7	4	*10,5
	14	1,5	100	15	11	9	4	*12,5
	16	1,5	100	15	12	9	4	*14,5

CODICE - CODE		
K43MF...V	K43MF...CT	*K43MJF... V
<input type="checkbox"/>	<input type="checkbox"/>	<input type="checkbox"/>
<input type="checkbox"/>	<input type="checkbox"/>	<input type="checkbox"/>
<input type="checkbox"/>	<input type="checkbox"/>	<input type="checkbox"/>

* Per MJ vedi tabella di foratura pag. 252
 * Drills' diameters for MJ: table page 252
 * Pour MJ voir le tableau de perçage page 252

* Rivestimento TiCN a richiesta
 * TiCN coating on request
 * Revêtement TiCN sur demande

Confezione / Box / Colis:
 M3 – M10: 10 pezzi / pcs
 M12 – M16: 5 pezzi / pcs

€ Pag. listino - Price list - Liste des prix

59

59

59

• Standard

○ Disponibilità da richiedere, prezzo a listino
 On enquiry, standard price-list / Stock à vérifier

★ Solo a richiesta
 Only on request / Sur demande

Ni

NICHEL

Nickel - Nickel

MASCHI A MACCHINA

MACHINE TAPS - TARAUDS MACHINE

UFS norm

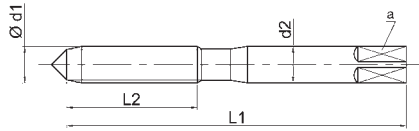

UFS norm

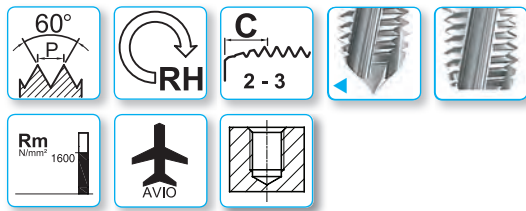
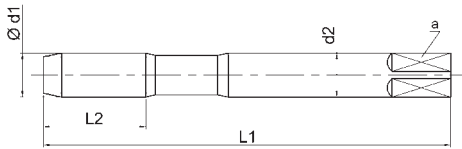

top



R10°

top



R10°

top



R10°

Profond. di filettatura - Thread depth - Profond. de filetage

Materiale - Material - Matériau

Tolleranza - Tolerance - Tolérance

Trattamento superficiale - Surface treatment - Revêtement

Numero gruppi materiali

Material's groups number

Nombre de groupes du matériau

1,5xD

PM3

6HX

BR

7.3 9.3

1,5xD

PM3

6HX

TiCN

1.6 5.4

7.2 9.1

1,5xD

PM3

4HX

BR

7.3 9.3

UFS norm	Ød1 MF	P mm	L ₁	L ₂	d ₂ h9	a h12	Z	
◀	8	1	90	25	8	6,2	3	*7
◀	10	1	100	30	10	8	3	*9
◀	10	1,25	100	30	10	8	3	*8,75
	12	1,25	110	30	12	9	4	*10,75
	12	1,5	110	30	12	9	4	*10,5
	14	1,5	110	30	12	9	4	*12,5
	16	1,5	110	30	16	12	4	*12,5

CODICE - CODE	K42MF...NI		
	K42MF...NI	K42MF...NI-CT	K42MF...NI-4HX
○	○	○	*
○	○	○	*
○	○	○	*
○	○	○	*
○	○	○	*
○	○	○	*
○	○	○	*

* Per MJ vedi tabella di foratura pag. 252
 * Drills' diameters for MJ: table page 252
 * Pour MJ voir le tableau de perçage page 252

Confezione / Box / Colis:
 M3 – M10: 10 pezzi / pcs
 M12 – M16: 5 pezzi / pcs

€ Pag. listino - Price list - Liste des prix

● Standard

59

○ Disponibilità da richiedere, prezzo a listino
 On enquiry, standard price-list / Stock à vérifier

59

59

* Solo a richiesta
 Only on request / Sur demande

MF Filettatura metrica ISO passo fine DIN 13

ISO metric fine thread DIN13

Metrisches ISO-Feingewinde DIN 13 – Maschinengewindebohrer
 Filetage métrique ISO à pas fin DIN 13 – Tarauds machine
 Rosca ISO métrica fina DIN 13 – Machos de rosca a máquina



N

USO GENERALE
 General purpose - Usage Général

MASCHI A MACCHINA

MACHINE TAPS - TARAUDS MACHINE

MF

DIN 371

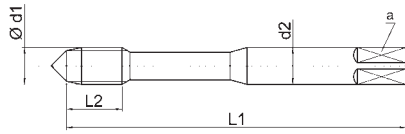

DIN 371

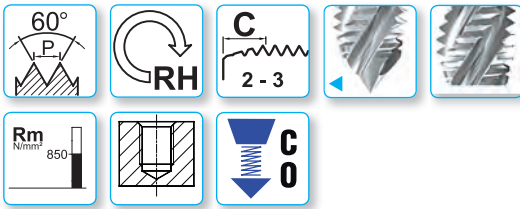
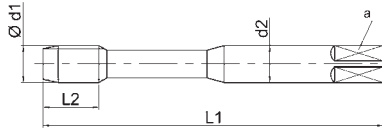

LINE



R40°

LINE



R40°

LINE



R40°

LINE



R40°

Profond. di filettatura - Thread depth - Profond. de filetage

Materiale - Material - Matériau

Tolleranza - Tolerance - Tolérance

Trattamento superficiale - Surface treatment - Revêtement

Numero gruppi materiali

Material's groups number

Nombre de groupes du matériau

2,5xD

HSSE

ISO2/6H

BR

1.1 1.2 1.3 1.4

4.1 4.2

5.1 5.2

2,5xD

HSSE

ISO2/6H

V

1.1 1.2 1.3 1.4

4.1 4.2

5.1 5.2

2,5xD

HSSE

ISO2/6H

TiN

1.1 1.2 1.3 1.4

3.3 3.4

4.1 4.2 4.3

5.1 5.2

2,5xD

HSSE

ISO2/6H

TXC

1.1 1.2 1.3 1.4

2.1 2.2 3.3 3.4

4.2 4.3

5.2

DIN 371	Ød1 MF	P mm	L1	L2	d2 h9	a h12	Z	
◀	4	0,5	63	7	4,5	3,4	3	3,5
◀	5	0,5	70	8	6	4,9	3	4,5
◀	6	0,75	80	10	6	4,9	3	5,25
	8	0,75	90	13	8	6,2	3	7,25
	8	1	90	13	8	6,2	3	7
	10	1	90	15	10	8	3	9
	10	1,25	100	15	10	8	3	8,75

E60MF...	CODICE - CODE		
	E60MF...V	E60MF...T	E60MF...TXC
○	○	○	○
○	○	○	○
●	○	○	●
○	○	○	○
●	○	○	●
●	○	○	●
●	○	○	●

Segue diametri
 Diameters, to be continued
 Diamètres à suivre

▶ Pag. 123...126

Confezione / Box / Colis:
 M3 – M10: 10 pezzi / pcs
 M12 – M16: 5 pezzi / pcs

€ Pag. listino - Price list - Liste des prix

59

59

59

60

● Standard

○ Disponibilità da richiedere, prezzo a listino
 On enquiry, standard price-list / Stock à vérifier

★ Solo a richiesta
 Only on request / Sur demande

N **USO GENERALE**
General purpose - Usage Général

MASCHI A MACCHINA

MACHINE TAPS - TARAUDS MACHINE

DIN 374

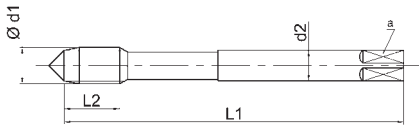

DIN 374

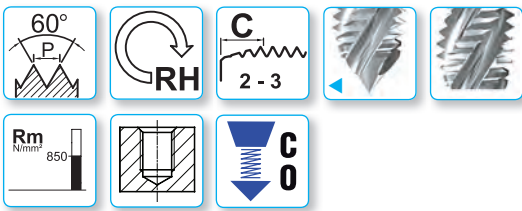
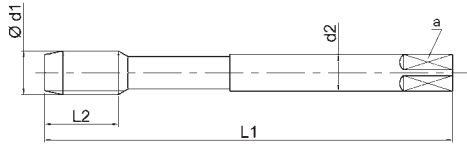

LINE



R40°

LINE



R40°

LINE



R40°

LINE



R40°

Profond. di filettatura - Thread depth - Profond. de filetage

Materiale - Material - Matériau

Tolleranza - Tolerance - Tolérance

Trattamento superficiale - Surface treatment - Revêtement

Numero gruppi materiali

Material's groups number

Nombre de groupes du matériau

2,5xD	2,5xD	2,5xD	2,5xD
HSSE	HSSE	HSSE	HSSE
ISO2/6H	ISO2/6H	ISO2/6H	ISO2/6H
BR	V	TiN	TXC
1.1 1.2 1.3 1.4	1.1 1.2 1.3 1.4	1.1 1.2 1.3 1.4	1.1 1.2 1.3 1.4
4.1 4.2	4.1 4.2	3.3 3.4	2.1 2.2 3.3 3.4
5.1 5.2	5.1 5.2	4.1 4.2 4.3	4.2 4.3
		5.1 5.2	5.2

DIN 374	Ød1 MF	P mm	L1	L2	d2 h9	a h12	Z	Z	
◀	6	0,75	80	10	4,5	3,4	3	5,25	
	8	0,75	90	13	6	4,9	3	7,25	
	8	1	90	13	6	4,9	3	7	
	9	1	90	18	7	5,5	3	8	
	10	1	90	15	7	5,5	3	9	
	10	1,25	100	15	7	5,5	3	8,75	
	11	1	100	15	8	6,2	3	10	
	12	1	100	13	9	7	3	11	
	12	1,25	100	13	9	7	3	10,75	
	12	1,5	100	13	9	7	3	10,5	
	13	1	100	15	11	9	4	12	
	14	1	100	15	11	9	4	13	
	14	1,25	100	15	11	9	4	12,75	
	14	1,5	100	15	11	9	4	12,5	
	15	1	100	22	12	9	4	14	
	15	1,5	100	22	12	9	4	13,5	
	16	1	100	15	12	9	4	15	
	16	1,5	100	15	12	9	4	14,5	
	17	1	110	25	14	11	4	16	
	17	1,5	110	25	14	11	4	15,5	
	18	1	110	17	14	11	4	17	
	18	1,5	110	17	14	11	4	16,5	
	18	2	125	25	14	11	4	16	
	20	1	125	17	16	12	4	19	
	20	1,5	125	17	16	12	4	18,5	
	20	2	140	25	16	12	4	18	

CODICE - CODE			
E61MF...	E61MF...V	E61MF...T	E61MF...TxC
○	○	○	○
○	○	○	○
○	○	○	○
○	○	○	○
○	○	○	○
○	○	○	○
○	○	○	○
○	○	○	○
○	○	○	○
○	○	○	○
○	○	○	○
○	○	○	○
○	○	○	○
○	○	○	○
○	○	○	○
○	○	○	○
○	○	○	○
○	○	○	○
○	○	○	○
○	○	○	○
○	○	○	○
○	○	○	○
○	○	○	○
○	○	○	○
○	○	○	○
○	○	○	○

Segue diametri
Diameters following
Diamètres à suivre ▶ Pag. 124...126

Confezione / Box / Colis: M3 – M10: 10 pezzi / pcs M12 – M16: 5 pezzi / pcs	€ Pag. listino - Price list - Liste des prix	60	60	60	62
	• Standard	○ Disponibilità da richiedere, prezzo a listino On enquiry, standard price-list / Stock à vérifier		★ Solo a richiesta Only on request / Sur demande	

MF Filettatura metrica ISO passo fine DIN 13

ISO metric fine thread DIN13

Metrisches ISO-Feingewinde DIN 13 - Maschinengewindebohrer
 Filetage métrique ISO à pas fin DIN 13 - Tarauds machine
 Rosca ISO métrica fina DIN 13 - Machos de rosca a máquina



N

USO GENERALE
 General purpose - Usage Général

MASCHI A MACCHINA

MACHINE TAPS - TARAUDS MACHINE

DIN 374

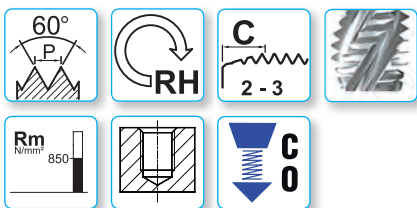
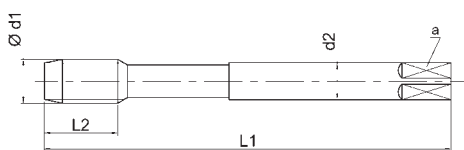

Profond. di filettatura - Thread depth - Profond. de filetage

Materiale - Material - Matériau

Tolleranza - Tolerance - Tolérance

Trattamento superficiale - Surface treatment - Revêtement

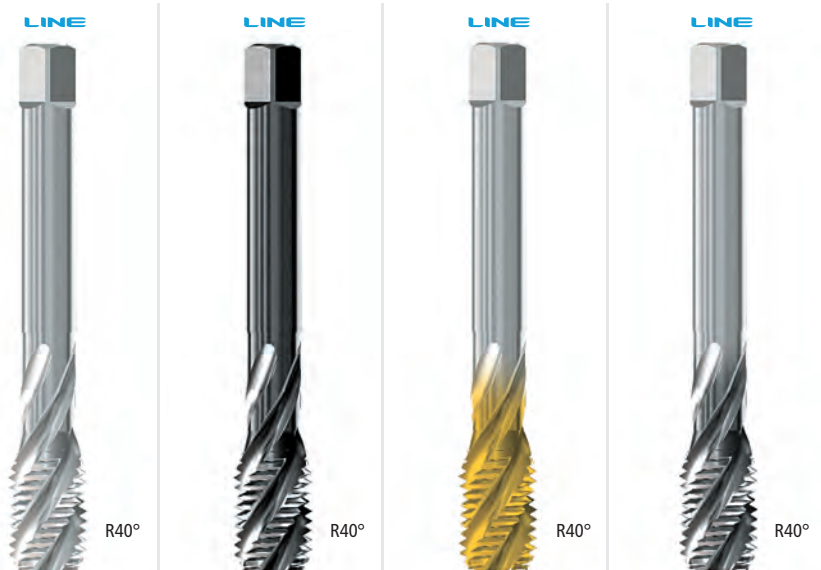

2,5xD 2,5xD 2,5xD 2,5xD

HSSE HSSE HSSE HSSE

ISO2/6H ISO2/6H ISO2/6H ISO2/6H

BR V TiN TxC

Numero gruppi materiali
 Material's groups number
 Nombre de groupes du matériau

1.1 1.2 1.3 1.4	1.1 1.2 1.3 1.4	1.1 1.2 1.3 1.4	1.1 1.2 1.3 1.4
4.1 4.2	4.1 4.2	3.3 3.4	2.1 2.2 3.3 3.4
5.1 5.2	5.1 5.2	4.1 4.2 4.3	4.2 4.3
		5.1 5.2	5.2

DIN 374	Ød1 MF	P mm	L1	L2	d2 h9	a h12	Z	
	21	1	125	18	18	14,5	4	20
	21	1,5	125	18	18	14,5	4	19,5
	21	2	140	25	18	14,5	4	19
	22	1	125	18	18	14,5	4	21
	22	1,5	125	18	18	14,5	4	20,5
	22	2	140	25	18	14,5	4	20
	24	1	140	20	18	14,5	4	23
	24	1,5	140	20	18	14,5	4	22,5
	24	2	140	20	18	14,5	4	22
	25	1	140	20	18	14,5	4	24
	25	1,5	140	20	18	14,5	4	23,5
	25	2	140	20	18	14,5	4	23
	26	1,5	140	20	18	14,5	4	24,5
	27	1	140	20	20	16	4	26
	27	1,5	140	20	20	16	4	25,5
	27	2	140	20	20	16	4	25
	28	1,5	140	20	20	16	4	26,5
	30	1,5	150	22	22	18	4	28,5
	30	2	150	22	22	18	4	28
	30	3	180	35	22	18	4	27
	32	1,5	150	22	22	18	5	30,5
	32	2	150	22	22	18	5	30
	33	1,5	160	24	25	20	5	31,5
	33	2	160	24	25	20	5	31
	33	3	180	35	25	20	4	30
	34	1,5	170	24	28	22	5	32,5
	35	1,5	170	24	28	22	5	33,5

E61MF...	CODICE - CODE		
	E61MF...V	E61MF...T	E61MF...TxC
○	○	○	○
○	○	○	○
○	○	○	○
○	○	○	○
●	○	○	○
○	○	○	○
○	○	○	○
○	○	○	○
○	○	○	○
○	○	○	○
○	○	○	○
○	○	○	○
○	○	○	○
○	○	○	○
○	○	○	○
○	○	○	○
○	○	○	○
○	○	○	○
○	○	○	○
○	○	○	○
○	○	○	○
○	○	○	○
○	○	○	○
○	○	○	○
○	○	○	○
○	○	○	○

Segue diametri
 Diameters, to be continued - Diamètres à suivre ▶ Pag. 125...126

N

USO GENERALE

General purpose - Usage Général

MASCHI A MACCHINA

MACHINE TAPS - TARAUDS MACHINE

~DIN 374

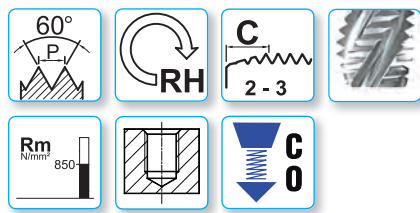
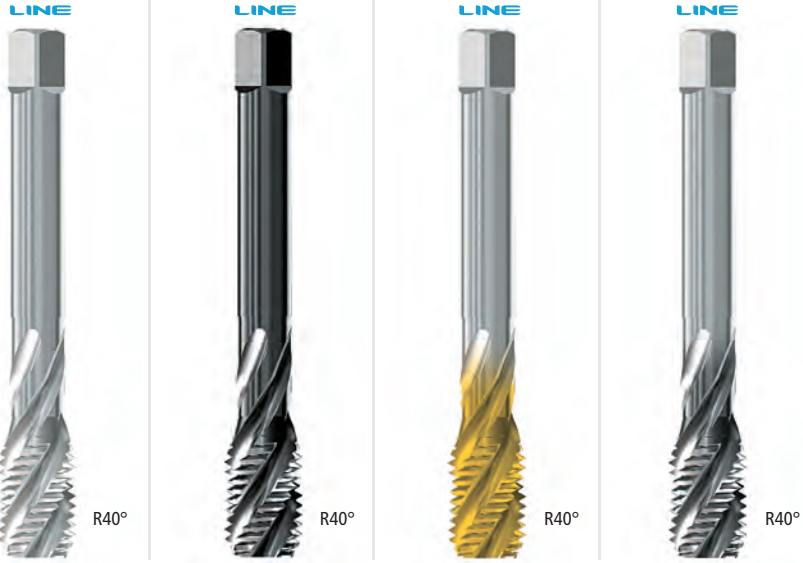
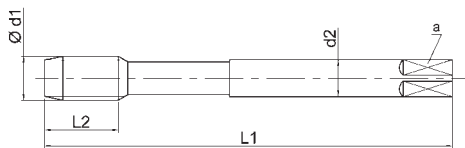

Profond. di filettatura - Thread depth - Profond. de filetage

Materiale - Material - Matériau

Tolleranza - Tolerance - Tolérance

Trattamento superficiale - Surface treatment - Revêtement

Numero gruppi materiali

Material's groups number

Nombre de groupes du matériau

2,5xD	2,5xD	2,5xD	2,5xD
HSSE	HSSE	HSSE	HSSE
ISO2/6H	ISO2/6H	ISO2/6H	ISO2/6H
BR	V	TiN	TXC
1.1 1.2 1.3 1.4	1.1 1.2 1.3 1.4	1.1 1.2 1.3 1.4	1.1 1.2 1.3 1.4
4.1 4.2	4.1 4.2	3.3 3.4	2.1 2.2 3.3 3.4
5.1 5.2	5.1 5.2	4.1 4.2 4.3	4.2 4.3
		5.1 5.2	5.2

~DIN 374	Ød1 MF	P mm	L1	L2	d2 h9	a h12	Z	Icon
	36	1,5	170	24	28	22	5	34,5
	36	2	170	24	28	22	5	34
	36	3	200	40	28	22	4	33
	37	1,5	170	24	28	22	6	35,5
	38	1,5	170	24	28	22	6	36,5
	39	1,5	170	25	32	24	6	37,5
	39	2	170	25	32	24	6	37
	39	3	200	40	32	24	4	36
	40	1,5	170	25	32	24	6	38,5
	40	2	170	25	32	24	6	38
	40	3	200	40	32	24	5	37
	42	1,5	170	25	32	24	6	40,5
	42	2	170	25	32	24	6	40
	42	3	200	40	32	24	5	39
■	45	1,5	180	27	36	29	6	43,5
■	45	2	180	27	36	29	6	43
■	45	3	200	32	36	29	5	42
■	48	1,5	190	27	36	29	6	46,5
■	48	2	190	27	36	29	6	46
■	*48	3	220	36	36	29	6	45
■	50	1,5	190	27	36	29	6	48,5
■	50	2	190	27	36	29	6	48
■	*50	3	220	36	36	29	6	47
■	52	1,5	190	27	40	32	6	50,5
■	52	2	190	27	40	32	6	50
■	*52	3	220	36	40	32	6	49

■ = Acciaio HSS / HSS Steel / Acier HSS
 * Dimensioni a norma UFS / Dimensions according UFS' norms / Dimensions selon norme UFS

CODICE - CODE			
E61MF...	E61MF...V	E61MF...T	E61MF...TXC
○	○	○	*
○	○	○	*
○	○	○	*
○	○	○	*
○	○	○	*
○	○	○	*
○	○	○	*
○	○	○	*
○	○	○	*
○	○	○	*
○	○	○	*
○	○	○	*
○	○	○	*
○	○	○	*
○	○	○	*
○	○	○	*
○	○	○	*
○	○	○	*
○	○	○	*
○	○	○	*
○	○	○	*
○	○	○	*
○	○	○	*
○	○	○	*

Segue diametri / Diameters, to be continued - Diamètres à suivre

Confezione / Box / Colis: M3 – M10: 10 pezzi / pcs M12 – M16: 5 pezzi / pcs	€ Pag. listino - Price list - Liste des prix	61	61	61	62
	● Standard	○ Disponibilità da richiedere, prezzo a listino On enquiry, standard price-list / Stock à vérifier		★ Solo a richiesta Only on request / Sur demande	

MF Filettatura metrica ISO passo fine DIN 13

ISO metric fine thread DIN13
 Metrisches ISO-Feingewinde DIN 13 – Maschinengewindebohrer
 Filetage métrique ISO à pas fin DIN 13 – Tarauds machine
 Rosca ISO métrica fina DIN 13 – Machos de roscar a máquina



N USO GENERALE
 General purpose - Usage Général

MASCHI A MACCHINA MACHINE TAPS - TARAUDS MACHINE

UFS norm

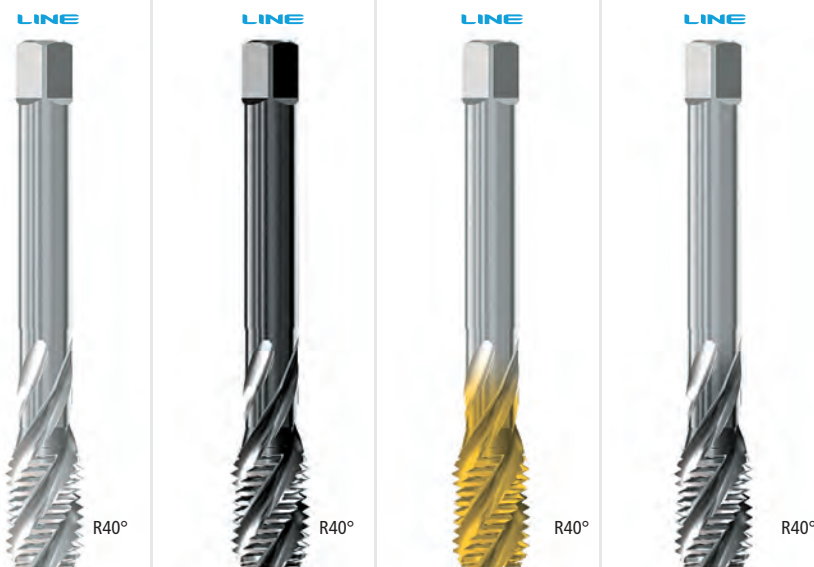
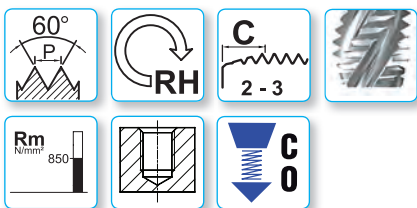
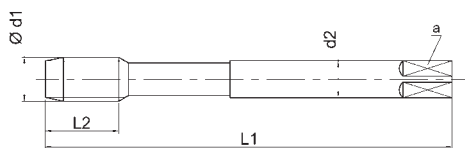

Profond. di filettatura - Thread depth - Profond. de filetage

Materiale - Material - Matériau

Tolleranza - Tolerance - Tolérance

Trattamento superficiale - Surface treatment - Revêtement

2,5xD	2,5xD	2,5xD	2,5xD
HSSE	HSSE	HSSE	HSSE
ISO2/6H	ISO2/6H	ISO2/6H	ISO2/6H
BR	V	TiN	TXC
1.1 1.2 1.3 1.4	1.1 1.2 1.3 1.4	1.1 1.2 1.3 1.4	1.1 1.2 1.3 1.4
4.1 4.2	4.1 4.2	3.3 3.4	2.1 2.2 3.3 3.4
5.1 5.2	5.1 5.2	4.1 4.2 4.3	4.2 4.3
		5.1 5.2	5.2

Numero gruppi materiali
 Material's groups number
 Nombre de groupes du matériau

UFS norm	Ød1 MF	P mm	L ₁	L ₂	d ₂ h9	a h12	Z	
	* 56	1,5	190	27	40	32	6	54,5
	* 56	2	190	27	40	32	6	54
	* 56	3	220	36	40	32	6	53
	* 56	4	220	36	40	32	6	52
	* 58	1,5	190	27	40	32	6	56,5
	* 58	2	190	27	40	32	6	56
	* 58	3	220	36	40	32	6	55
	* 58	4	220	36	40	32	6	54
	* 60	1,5	190	27	45	35	6	58,5
	* 60	2	190	27	45	35	6	58
	* 60	3	220	36	45	35	6	57
	* 60	4	220	36	45	35	6	56

= Acciaio HSS / HSS Steel / Acier HSS
 * Dimensioni a norma UFS / Dimensions according UFS' norms / Dimensions selon norme UFS

E61MF...	CODICE - CODE			E61MF...TXC
	E61MF...V	E61MF...T		
<input type="radio"/>	<input type="radio"/>	<input type="radio"/>		*
<input type="radio"/>	<input type="radio"/>	<input type="radio"/>		*
<input type="radio"/>	<input type="radio"/>	<input type="radio"/>		*
<input type="radio"/>	<input type="radio"/>	<input type="radio"/>		*
<input type="radio"/>	<input type="radio"/>	<input type="radio"/>		*
<input type="radio"/>	<input type="radio"/>	<input type="radio"/>		*
<input type="radio"/>	<input type="radio"/>	<input type="radio"/>		*
<input type="radio"/>	<input type="radio"/>	<input type="radio"/>		*
<input type="radio"/>	<input type="radio"/>	<input type="radio"/>		*
<input type="radio"/>	<input type="radio"/>	<input type="radio"/>		*
<input type="radio"/>	<input type="radio"/>	<input type="radio"/>		*
<input type="radio"/>	<input type="radio"/>	<input type="radio"/>		*
<input type="radio"/>	<input type="radio"/>	<input type="radio"/>		*
<input type="radio"/>	<input type="radio"/>	<input type="radio"/>		*

Confezione / Box / Colis: M3 – M10: 10 pezzi / pcs M12 – M16: 5 pezzi / pcs	€ Pag. listino - Price list - Liste des prix	61	61	61	62
	• Standard	○ Disponibilità da richiedere, prezzo a listino On enquiry, standard price-list / Stock à vérifier		★ Solo a richiesta Only on request / Sur demande	

N USO GENERALE
General purpose - Usage Général

MASCHI A MACCHINA
MACHINE TAPS - TARAUDS MACHINE

DIN 371

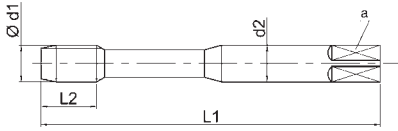

DIN 374

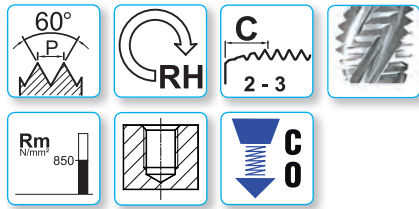
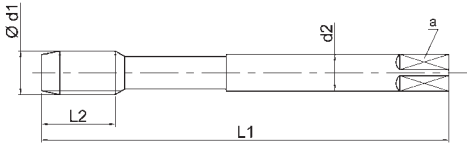

LINE



R40°

LINE



R40°

LINE



R40°

Profond. di filettatura - Thread depth - Profond. de filetage

Materiale - Material - Matériau

Tolleranza - Tolerance - Tolérance

Trattamento superficiale - Surface treatment - Revêtement

Numero gruppi materiali

Material's groups number

Nombre de groupes du matériau

3xD

HSSE

ISO2/6H

BR

1.1 1.2 1.3 1.4

4.1 4.2

5.1 5.2

3xD

HSSE

ISO2/6H

TiN

1.1 1.2 1.3 1.4

3.3 3.4

4.1 4.2 4.3

5.1 5.2

3xD

HSSE

ISO2/6H

TXC

1.1 1.2 1.3 1.4

2.1 2.2 3.3 3.4

4.2 4.3

5.2

DIN 371	Ød1 MF	P mm	L1	L2	d2 h9	a h12	Z	
	8	1	90	13	8	6,2	3	7
	10	1	90	15	10	8	3	9
	10	1,25	100	15	10	8	3	8,75

CODICE - CODE		
E60MF...FOR	E60MF...FOR-T	E60MF...FOR-TXC
<input type="radio"/>	<input type="radio"/>	<input type="radio"/>
<input type="radio"/>	<input type="radio"/>	<input type="radio"/>
<input type="radio"/>	<input type="radio"/>	<input type="radio"/>

DIN 374	Ød1 MF	P mm	L1	L2	d2 h9	a h12	Z	
	12	1,25	100	13	9	7	3	10,75
	12	1,5	100	13	9	7	3	10,5
	14	1,5	100	15	11	9	4	12,5
	16	1,5	100	15	12	9	4	14,5

CODICE - CODE		
E61MF...FOR	E61MF...FOR-T	E61MF...FOR-TXC
<input type="radio"/>	<input type="radio"/>	<input type="radio"/>
<input type="radio"/>	<input type="radio"/>	<input type="radio"/>
<input type="radio"/>	<input type="radio"/>	<input type="radio"/>
<input type="radio"/>	<input type="radio"/>	<input type="radio"/>

MF Filettatura metrica ISO passo fine DIN 13

ISO metric fine thread DIN13

Metrisches ISO-Feingewinde DIN 13 – Maschinengewindebohrer
Filetage métrique ISO à pas fin DIN 13 – Tarauds machine
Rosca ISO métrica fina DIN 13 – Machos de roscar a máquina



N

USO GENERALE

General purpose - Usage Général

MASCHI A MACCHINA, FILETTATURA SINISTRA

LEFT THREAD MACHINE TAPS - TARAUDS MACHINE GAUCHE

MF

DIN 371

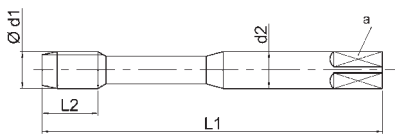

DIN 374

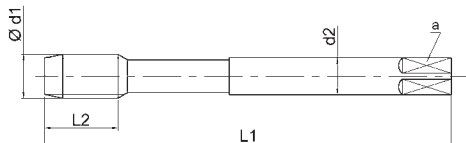

LINE



L 35°

LINE



L 35°

LINE



L 35°

Profond. di filettatura - Thread depth - Profond. de filetage

Materiale - Material - Matériau

Tolleranza - Tolerance - Tolérance

Trattamento superficiale - Surface treatment - Revêtement

Numero gruppi materiali

Material's groups number

Nombre de groupes du matériau

2,5xD	2,5xD	2,5xD
HSSE	HSSE	HSSE
ISO2/6H	ISO2/6H	ISO2/6H
BR	V	XP
1.1 1.2 1.3 1.4	1.1 1.2 1.3 1.4	1.1 1.2 1.3 1.4
4.1 4.2	4.1 4.2	2.1 2.2 3.3 3.4
5.1 5.2	5.1 5.2	4.2 4.3
		5.2

DIN 371	Ød1	P	L1	L2	d2	a	Z	
MF	mm				h9	h12		
8	1	90	13	8	6,2	3	7	
10	1	90	15	10	8	3	9	
10	1,25	100	15	10	8	3	8,75	

CODICE - CODE		
E60MF...LH	E60MF...LH-V	E60MF...LH-XP
○	○	○
○	○	○
○	○	○

DIN 374	Ød1	P	L1	L2	d2	a	Z	
MF	mm				h9	h12		
8	1	90	13	6	4,9	3	7	
10	1	90	15	7	5,5	3	9	
10	1,25	100	15	7	5,5	3	8,75	
12	1,25	100	13	9	7	3	10,75	
12	1,5	100	13	9	7	3	10,5	
14	1,5	100	15	11	9	4	12,5	
16	1,5	100	15	12	9	4	14,5	

CODICE - CODE		
E61MF...LH	E61MF...LH-V	E61MF...LH-XP
○	○	○
○	○	○
○	○	○
○	○	○
○	○	○
○	○	○

Confezione / Box / Colis:
M3 – M10: 10 pezzi / pcs
M12 – M16: 5 pezzi / pcs

€ Pag. listino - Price list - Liste des prix

63

63

63

● Standard

○ Disponibilità da richiedere, prezzo a listino
On enquiry, standard price-list / Stock à vérifier

★ Solo a richiesta
Only on request / Sur demande

N **USO GENERALE**
General purpose - Usage Général

MASCHI A MACCHINA
MACHINE TAPS - TARAUDS MACHINE

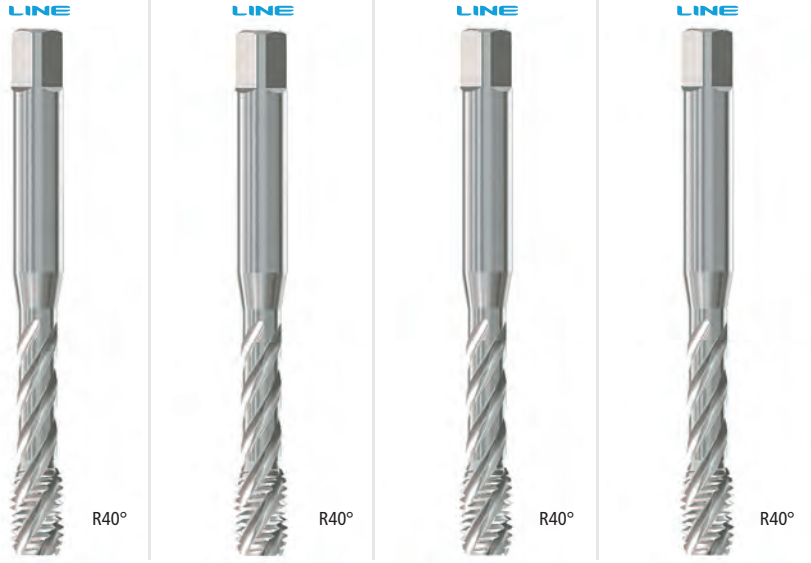
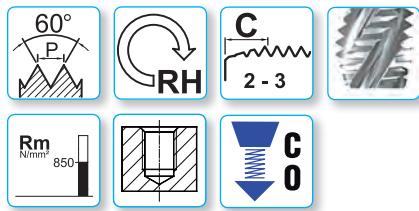
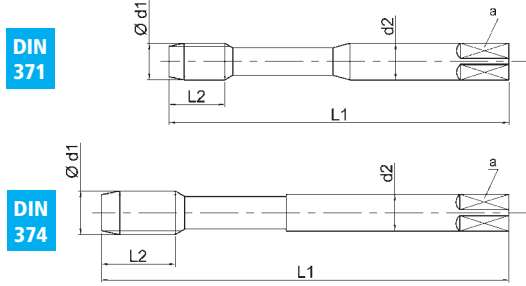

Profond. di filettatura - Thread depth - Profond. de filetage	2,5xD	2,5xD	2,5xD	2,5xD
Materiale - Material - Matériau	HSSE	HSSE	HSSE	HSSE
Tolleranza - Tolerance - Tolérance	ISO1/4H	ISO3/6G	7G(6H+0,05)	6H+0,1
Trattamento superficiale - Surface treatment - Revêtement	BR	BR	BR	BR
Numero gruppi materiali Material's groups number Nombre de groupes du matériau	1.1 1.2 1.3 1.4 4.1 4.2 5.1 5.2	1.1 1.2 1.3 1.4 4.1 4.2 5.1 5.2	1.1 1.2 1.3 1.4 4.1 4.2 5.1 5.2	1.1 1.2 1.3 1.4 4.1 4.2 5.1 5.2

DIN 371	Ød1 MF	P mm	L1	L2	d2 h9	a h12	Z	
	8	1	90	13	8	6,2	3	7
	10	1	90	15	10	8	3	9
	10	1,25	100	15	10	8	3	8,75

CODICE - CODE			
E60MF...-4H	E60MF...-6G	E60MF...-7G	E60MF...+0,1
*	*	*	*
*	*	*	*
*	*	*	*

DIN 374	Ød1 MF	P mm	L1	L2	d2 h9	a h12	Z	
	8	1	90	13	6	4,9	3	7
	10	1	90	15	7	5,5	3	9
	10	1,25	100	15	7	5,5	3	8,75
	12	1,25	100	13	9	7	3	10,75
	12	1,5	100	13	9	7	3	10,5
	14	1,5	100	15	11	9	4	12,5
	16	1,5	100	15	12	9	4	14,5

CODICE - CODE			
E61MF...-4H	E61MF...-6G	E61MF...-7G	E61MF...+0,1
o	o	o	o
o	o	o	o
o	o	o	o
o	o	o	o
o	o	o	o
o	o	o	o
o	o	o	o

Confezione / Box / Colis: M3 – M10: 10 pezzi / pcs M12 – M16: 5 pezzi / pcs	€ Pag. listino - Price list - Liste des prix	63	63	63	63
	• Standard	o Disponibilità da richiedere, prezzo a listino On enquiry, standard price-list / Stock à vérifier		★ Solo a richiesta Only on request / Sur demande	

N **USO GENERALE R ≤ 1000N/mm²**
 General purpose R ≤ 1000N/mm² - Usage Général R ≤ 1000N/mm²

MASCHI A MACCHINA
 MACHINE TAPS - TARAUDS MACHINE

DIN 371

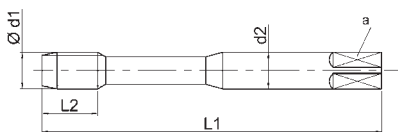

DIN 374

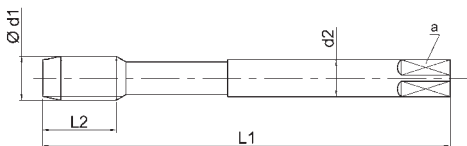

60°

RH

C 2-3

Rm 1000 / 850

8%Co

SR



Profond. di filettatura - Thread depth - Profond. de filetage

Materiale - Material - Matériau

Tolleranza - Tolerance - Tolérance

Trattamento superficiale - Surface treatment - Revêtement

Numero gruppi materiali
 Material's groups number
 Nombre de groupes du matériau

2,5xD	2,5xD	2,5xD	2,5xD
HSSP	HSSP	HSSP	HSSP
ISO2/6H	ISO2/6H	ISO2/6H	ISO2/6H
BR	V	TiN	XP
1.1 1.2 1.3 1.4	1.1 1.2 1.3 1.4	1.1 1.2 1.3 1.4 1.5	1.1 1.2 1.3 1.4 1.5
4.1 4.2	4.1 4.2	3.3 3.4 4.1 4.2 4.3	2.1 2.2
5.1 5.2	5.1 5.2	5.1 5.2	3.3 3.4 4.2 4.3
			5.2

DIN 371	Ød1 MF	P mm	L1	L2	d2 h9	a h12	Z	
	8	1	90	13	8	6,2	3	7
	10	1	90	15	10	8	3	9
	10	1,25	100	15	10	8	3	8,75

CODICE - CODE			
P60MF...	P60MF...V	P60MF...T	P60MF...XP
○	○	○	○
○	○	○	○
○	○	○	○

DIN 374	Ød1 MF	P mm	L1	L2	d2 h9	a h12	Z	
	8	1	90	13	6	4,9	3	7
	10	1	90	15	7	5,5	3	9
	10	1,25	100	15	7	5,5	3	8,75
	12	1	100	13	9	7	4	11
	12	1,25	100	13	9	7	4	10,75
	12	1,5	100	13	9	7	4	10,5
	14	1,5	100	15	11	9	4	12,5
	16	1,5	100	15	12	9	4	14,5
	18	1,5	110	17	14	11	4	16,5
	20	1,5	125	17	16	12	4	18,5

CODICE - CODE			
P61MF...	P61MF...V	P61MF...T	P61MF...XP
○	○	○	○
○	○	○	○
○	○	○	○
○	○	○	○
○	○	○	○
○	○	○	○
○	○	○	○
○	○	○	○
*	*	*	*
*	*	*	*
*	*	*	*
*	*	*	*

★ Solo a richiesta
 Only on request / Sur demande

RACCOMANDATO per filettatura rigida
 We recommend Syncro rigid threading
 Recommandé pour le taraudage rigide

Confezione / Box / Colis: M3 – M10: 10 pezzi / pcs M12 – M16: 5 pezzi / pcs	€ Pag. listino - Price list - Liste des prix	64	64	64	64
	• Standard	○ Disponibilità da richiedere, prezzo a listino On enquiry, standard price-list / Stock à vérifier			

MF Filettatura metrica ISO passo fine DIN 13

ISO metric fine thread DIN13

Metrisches ISO-Feingewinde DIN 13 – Maschinengewindebohrer
 Filetage métrique ISO à pas fin DIN 13 – Tarauds machine
 Rosca ISO métrica fina DIN 13 – Machos de roscar a máquina



N

USO GENERALE
 General purpose - Usage Général

MASCHI A MACCHINA

MACHINE TAPS - TARAUDS MACHINE

DIN 371

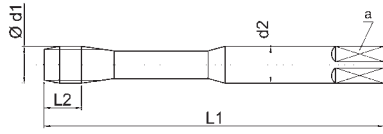

DIN 374

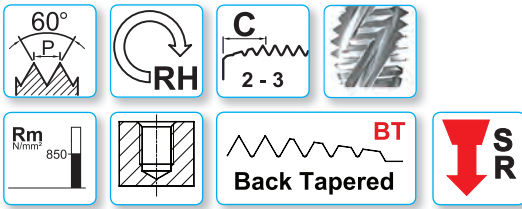
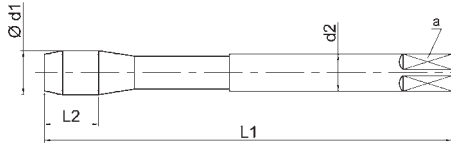

Profond. di filettatura - Thread depth - Profond. de filetage

Materiale - Material - Matériau

Tolleranza - Tolerance - Tolérance

Trattamento superficiale - Surface treatment - Revêtement

Numero gruppi materiali
 Material's groups number
 Nombre de groupes du matériau

2,5÷3xD	2,5÷3xD	2,5÷3xD	2,5÷3xD
HSSE	HSSE	HSSE	HSSE
ISO2/6H	ISO2/6H	ISO2/6H	ISO2/6H
BR	V	TiN	XP
1.1 1.2 1.3 1.4	1.1 1.2 1.3 1.4	1.1 1.2 1.3 1.4	1.1 1.2 1.3 1.4
5.1 5.2	2.1 2.2	5.1 5.2	2.1 2.2
	5.1 5.2		5.2

DIN 371	Ød1 MF	P mm	L1	L2	d2 h9	a h12	Z	
	8	1	90	13	8	6,2	3	7
	10	1	90	15	10	8	3	9
	10	1,25	100	15	10	8	3	8,75

CODICE - CODE			
E80MF...	E80MF...V	E80MF...T	E80MF...XP
<input type="radio"/>	<input type="radio"/>	<input type="radio"/>	<input type="radio"/>
<input type="radio"/>	<input type="radio"/>	<input type="radio"/>	<input type="radio"/>
<input type="radio"/>	<input type="radio"/>	<input type="radio"/>	<input type="radio"/>

DIN 374	Ød1 MF	P mm	L1	L2	d2 h9	a h12	Z	
	8	1	90	13	6	4,9	3	7
	10	1	90	15	7	5,5	3	9
	10	1,25	100	15	7	5,5	3	8,75
	12	1	100	13	9	7	3	11
	12	1,25	100	13	9	7	3	10,75
	12	1,5	100	13	9	7	3	10,5
	14	1,5	100	15	11	9	4	12,5
	16	1,5	100	15	12	9	4	14,5
	18	1,5	110	17	14	11	4	16,5
	20	1,5	125	17	16	12	4	18,5

CODICE - CODE			
E81MF...	E81MF...V	E81MF...T	E81MF...XP
<input checked="" type="radio"/>	<input type="radio"/>	<input type="radio"/>	<input type="radio"/>
<input checked="" type="radio"/>	<input type="radio"/>	<input type="radio"/>	<input type="radio"/>
<input checked="" type="radio"/>	<input type="radio"/>	<input type="radio"/>	<input type="radio"/>
<input checked="" type="radio"/>	<input type="radio"/>	<input type="radio"/>	<input type="radio"/>
<input checked="" type="radio"/>	<input type="radio"/>	<input type="radio"/>	<input type="radio"/>
<input checked="" type="radio"/>	<input type="radio"/>	<input type="radio"/>	<input type="radio"/>
<input checked="" type="radio"/>	<input type="radio"/>	<input type="radio"/>	<input type="radio"/>
<input checked="" type="radio"/>	<input type="radio"/>	<input type="radio"/>	<input type="radio"/>
<input checked="" type="radio"/>	<input type="radio"/>	<input type="radio"/>	<input type="radio"/>

RACCOMANDATO per filettatura rigida
 We recommend Syncro rigid threading
 Recommandé pour le taraudage rigide

***** Ad esaurimento scorte
 Stock clearance - Stock épuisé

Vedi nuova serie - See new series - Voir nouvelle série
 E93 pag. XXXIV

Confezione / Box / Colis: M3 – M10: 10 pezzi / pcs M12 – M16: 5 pezzi / pcs	€ Pag. listino - Price list - Liste des prix	64	64	64	64
• Standard	○ Disponibilità da richiedere, prezzo a listino On enquiry, standard price-list / Stock à vérifier			★ Solo a richiesta Only on request / Sur demande	

N USO GENERALE
General purpose - Usage Général

MASCHI A MACCHINA
MACHINE TAPS - TARAUDS MACHINE

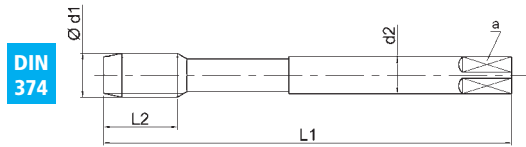

DIN 374

60° P
RH
C 2-3
Rm 850
SR

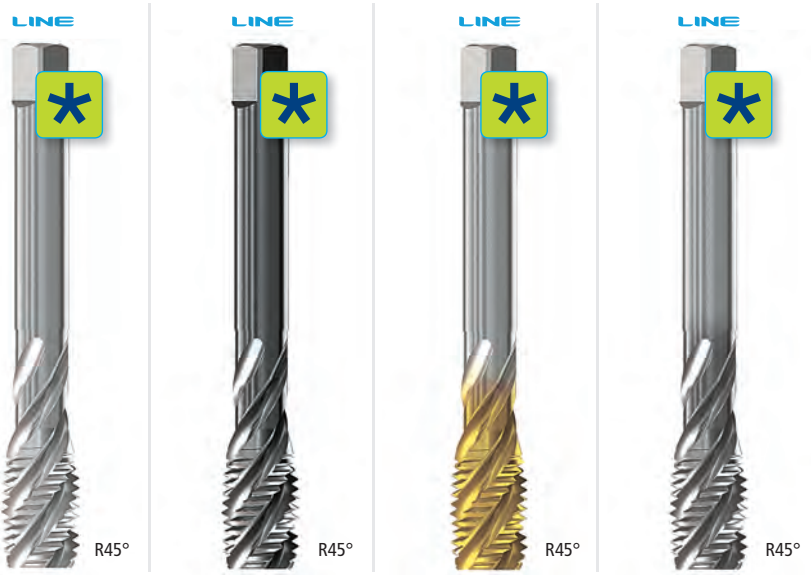

Profond. di filettatura - Thread depth - Profond. de filetage
Materiale - Material - Matériau
Tolleranza - Tolerance - Tolérance
Trattamento superficiale - Surface treatment - Revêtement
Numero gruppi materiali
Material's groups number
Nombre de groupes du matériau

3xD	3xD	3xD	3xD
HSSE	HSSE	HSSE	HSSE
ISO2/6H	ISO2/6H	ISO2/6H	ISO2/6H
BR	V	TiN	XP
1.1 1.2 1.3 1.4	1.1 1.2 1.3 1.4	1.1 1.2 1.3 1.4	1.1 1.2 1.3 1.4
4.2 5.2	2.1 2.2	4.2 5.2	2.1 2.2
	4.2 5.2		4.2 5.2

DIN 374	Ød1 MF	P mm	L1	L2	d2 h9	a h12	Z	
	8	1	90	13	6	4,9	3	7
	10	1	90	15	7	5,5	3	9
	10	1,25	100	15	7	5,5	3	8,75
	12	1	100	13	9	7	4	11
	12	1,25	100	13	9	7	4	10,75
	12	1,5	100	13	9	7	4	10,5
	14	1,5	100	15	11	9	4	12,5
	16	1,5	100	15	12	9	4	14,5
	18	1,5	110	17	14	11	4	16,5
	20	1,5	125	17	16	12	4	18,5

CODICE - CODE			
E83MF...	E83MF...V	E83MF...T	E83MF...XP
<input type="checkbox"/>	<input type="checkbox"/>	<input type="checkbox"/>	<input type="checkbox"/>
<input type="checkbox"/>	<input type="checkbox"/>	<input type="checkbox"/>	<input type="checkbox"/>
<input type="checkbox"/>	<input type="checkbox"/>	<input type="checkbox"/>	<input type="checkbox"/>
<input type="checkbox"/>	<input type="checkbox"/>	<input type="checkbox"/>	<input type="checkbox"/>
<input type="checkbox"/>	<input type="checkbox"/>	<input type="checkbox"/>	<input type="checkbox"/>
<input type="checkbox"/>	<input type="checkbox"/>	<input type="checkbox"/>	<input type="checkbox"/>
<input type="checkbox"/>	<input type="checkbox"/>	<input type="checkbox"/>	<input type="checkbox"/>
<input type="checkbox"/>	<input type="checkbox"/>	<input type="checkbox"/>	<input type="checkbox"/>
<input type="checkbox"/>	<input type="checkbox"/>	<input type="checkbox"/>	<input type="checkbox"/>
<input type="checkbox"/>	<input type="checkbox"/>	<input type="checkbox"/>	<input type="checkbox"/>

RACCOMANDATO per filettatura rigida
We recommend Syncro rigid threading
Recommandé pour le taraudage rigide



Versione ad alto rendimento in PM3 pagina seguente.
High performance PM3 edition in following page.
Version haut performance en PM3 page suivante.

***** Ad esaurimento scorte
Stock clearance - Stock épuisé

Confezione / Box / Colis: M3 – M10: 10 pezzi / pcs M12 – M16: 5 pezzi / pcs	€ Pag. listino - Price list - Liste des prix	65	65	65	65
	• Standard	o Disponibilità da richiedere, prezzo a listino On enquiry, standard price-list / Stock à vérifier			

MASCHI A MACCHINA

MACHINE TAPS - TARAUDS MACHINE

DIN 374

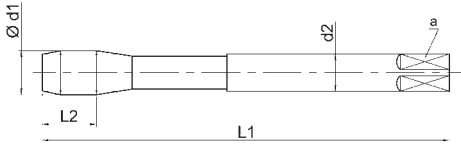

- 60° P
- RH
- C 2-3
- Rm N/mm² 1200
- Back Tapered BT
- SR

Profond. di filettatura - Thread depth - Profond. de filetage

Materiale - Material - Matériau

Tolleranza - Tolerance - Tolérance

Trattamento superficiale - Surface treatment - Revêtement

Numero gruppi materiali

Material's groups number

Nombre de groupes du matériau

top



3xD

PM3

6HX

XP

1.1	1.2	1.3	1.4	1.5
2.1	2.2	2.3		
3.3	3.4	4.2	4.3	
5.2				

top



3,5xD

PM3

6HX

XP

1.1	1.2	1.3	1.4	1.5
2.1	2.2	2.3		
3.3	3.4	4.2	4.3	
5.2				

top



3,5xD

PM3

6HX

XP

1.1	1.2	1.3	1.4	1.5
2.1	2.2	2.3		
3.3	3.4	4.2	4.3	
5.2				

DIN 374	Ød1 MF	P mm	L ₁	L ₂	d ₂ h9	a h12	Z	
8	1	90	13	6	4,9	3	7	
10	1	90	15	7	5,5	3	9	
10	1,25	100	15	7	5,5	3	8,75	
12	1	100	13	9	7	4	11	
12	1,25	100	13	9	7	4	10,75	
12	1,5	100	13	9	7	4	10,5	
14	1,5	100	15	11	9	4	12,5	
16	1,5	100	15	12	9	4	14,5	
18	1,5	110	17	14	11	4	16,5	
20	1,5	125	17	16	12	4	18,5	
22	1,5	125	18	18	14,5	4	20,5	
24	1,5	140	20	18	14,5	4	22,5	

CODICE - CODE		K83MF...XP			K83MF...FOR-XP			K83MF...FORY-XP		
○	○	○	○	○	○	○	○	○	○	
○	○	○	○	○	○	○	○	○	○	
○	○	○	○	○	○	○	○	○	○	
○	○	○	○	○	○	○	○	○	○	
○	○	○	○	○	○	○	○	○	○	
○	○	○	○	○	○	○	○	○	○	
○	○	○	○	○	○	○	○	○	○	
○	○	○	○	○	○	○	○	○	○	
○	○	○	○	○	○	○	○	○	○	
○	○	○	○	○	○	○	○	○	○	
○	○	○	○	○	○	○	○	○	○	
○	○	○	○	○	○	○	○	○	○	
○	○	○	○	○	○	○	○	○	○	
○	○	○	○	○	○	○	○	○	○	
○	○	○	○	○	○	○	○	○	○	
○	○	○	○	○	○	○	○	○	○	
○	○	○	○	○	○	○	○	○	○	
○	○	○	○	○	○	○	○	○	○	
○	○	○	○	○	○	○	○	○	○	
○	○	○	○	○	○	○	○	○	○	
○	○	○	○	○	○	○	○	○	○	
○	○	○	○	○	○	○	○	○	○	
○	○	○	○	○	○	○	○	○	○	
○	○	○	○	○	○	○	○	○	○	

RACCOMANDATO per filettatura rigida
 We recommend Syncro rigid threading
 Recommandé pour le taraudage rigide



Confezione / Box / Colis: M3 – M10: 10 pezzi / pcs M12 – M16: 5 pezzi / pcs	€ Pag. listino - Price list - Liste des prix	65	65	65
● Standard	○ Disponibilità da richiedere, prezzo a listino On enquiry, standard price-list / Stock à vérifier	○	○	★ Solo a richiesta Only on request / Sur demande

MF Filettatura metrica ISO passo fine DIN 13

ISO metric fine thread DIN13

Metrisches ISO-Feingewinde DIN 13 – Maschinengewindebohrer
 Filetage métrique ISO à pas fin DIN 13 – Tarauds machine
 Rosca ISO métrica fina DIN 13 – Machos de roscar a máquina



HR

ALTA RESISTENZA
 High Resistance - Haute Résistance

MASCHI A MACCHINA

MACHINE TAPS - TARAUDS MACHINE

DIN 374

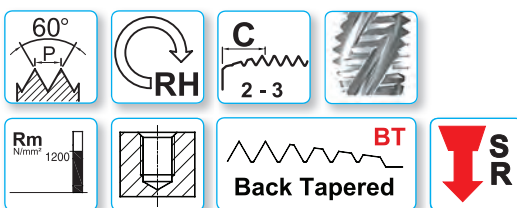
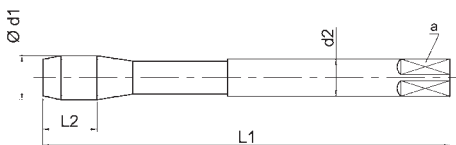

Profond. di filettatura - Thread depth - Profond. de filetage

Materiale - Material - Matériau

Tolleranza - Tolerance - Tolérance

Trattamento superficiale - Surface treatment - Revêtement

Numero gruppi materiali
 Material's groups number
 Nombre de groupes du matériau

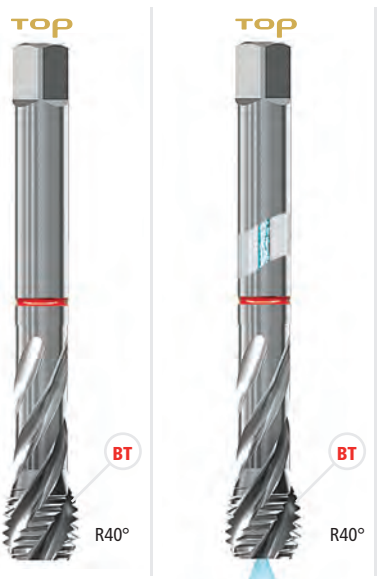

2,5xD	3xD
PM3	PM3
6HX	6HX
TXC	TXC
1.4 1.5	1.4 1.5
3.3 3.4	3.3 3.4

DIN 374	Ød1 MF	P mm	L ₁	L ₂	d ₂ h9	a h12	Z	
	8	1	90	13	6	4,9	3	7
	10	1	90	15	7	5,5	3	9
	10	1,25	100	15	7	5,5	3	8,75
	12	1	100	13	9	7	4	11
	12	1,25	100	13	9	7	4	10,75
	12	1,5	100	13	9	7	4	10,5
	14	1,5	100	15	11	9	4	12,5
	16	1,5	100	15	12	9	4	14,5

CODICE - CODE	
K81MF...TXC	K81MF...FOR-TXC
<input type="checkbox"/>	<input type="checkbox"/>
<input type="checkbox"/>	<input type="checkbox"/>
<input type="checkbox"/>	<input type="checkbox"/>
<input type="checkbox"/>	<input type="checkbox"/>
<input type="checkbox"/>	<input type="checkbox"/>
<input type="checkbox"/>	<input type="checkbox"/>
<input type="checkbox"/>	<input type="checkbox"/>
<input type="checkbox"/>	<input type="checkbox"/>
<input type="checkbox"/>	<input type="checkbox"/>
<input type="checkbox"/>	<input type="checkbox"/>
<input type="checkbox"/>	<input type="checkbox"/>
<input type="checkbox"/>	<input type="checkbox"/>
<input type="checkbox"/>	<input type="checkbox"/>
<input type="checkbox"/>	<input type="checkbox"/>
<input type="checkbox"/>	<input type="checkbox"/>
<input type="checkbox"/>	<input type="checkbox"/>
<input type="checkbox"/>	<input type="checkbox"/>
<input type="checkbox"/>	<input type="checkbox"/>
<input type="checkbox"/>	<input type="checkbox"/>
<input type="checkbox"/>	<input type="checkbox"/>
<input type="checkbox"/>	<input type="checkbox"/>
<input type="checkbox"/>	<input type="checkbox"/>
<input type="checkbox"/>	<input type="checkbox"/>
<input type="checkbox"/>	<input type="checkbox"/>
<input type="checkbox"/>	<input type="checkbox"/>

RACCOMANDATO per filettatura rigida
 We recommend Synchro rigid threading
 Recommandé pour le taraudage rigide



INOX

ACCIAIO INOSSIDABILE

Stainless steel - Acier inoxydable

MASCHI A MACCHINA

MACHINE TAPS - TARAUDS MACHINE

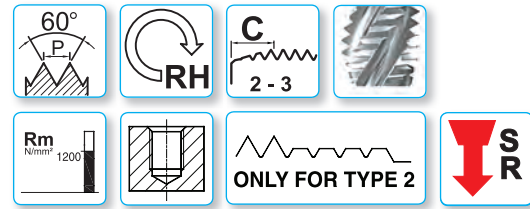
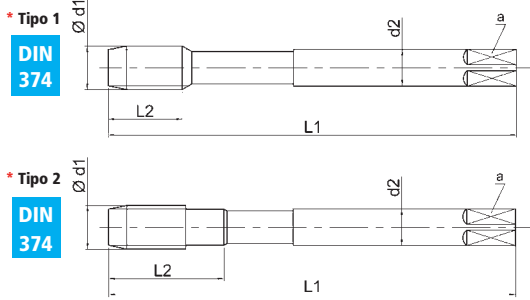

Profond. di filettatura - Thread depth - Profond. de filetage
 Materiale - Material - Matériau
 Tolleranza - Tolerance - Tolérance
 Trattamento superficiale - Surface treatment - Revêtement

Numero gruppi materiali
 Material's groups number
 Nombre de groupes du matériau

DIN 374	Ød1 MF	P mm	L1	L2	d2 h9	a h12	Z	Image
	8	1	90	13	6	4,9	3	7
	10	1	90	15	7	5,5	3	9
	10	1,25	100	15	7	5,5	3	8,75
	12	1	100	13	9	7	4	11
	12	1,25	100	13	9	7	4	10,75
	12	1,5	100	13	9	7	4	10,5
	14	1,5	100	15	11	9	4	12,5
	16	1,5	100	15	12	9	4	14,5
	18	1,5	110	17	14	11	4	16,5
	20	1,5	125	17	16	12	4	18,5
	22	1,5	125	18	18	14,5	4	20,5
	24	1,5	140	20	18	14,5	4	22,5
	8	1	90	18	6	4,9	3	7
	10	1	90	15	7	5,5	3	9
	10	1,25	100	20	7	5,5	3	8,75
	12	1	100	22	9	7	4	11
	12	1,25	100	22	9	7	4	10,75
	12	1,5	100	22	9	7	4	10,5
	14	1,5	100	22	11	9	4	12,5
	16	1,5	100	22	12	9	4	14,5

* Tipo 1: Non rastremato / Not tapered / Sans Détalonnage
 * Tipo 2: Rastremato secondo dis:
 Back tapered according picture / Détalonnage selon dessin:

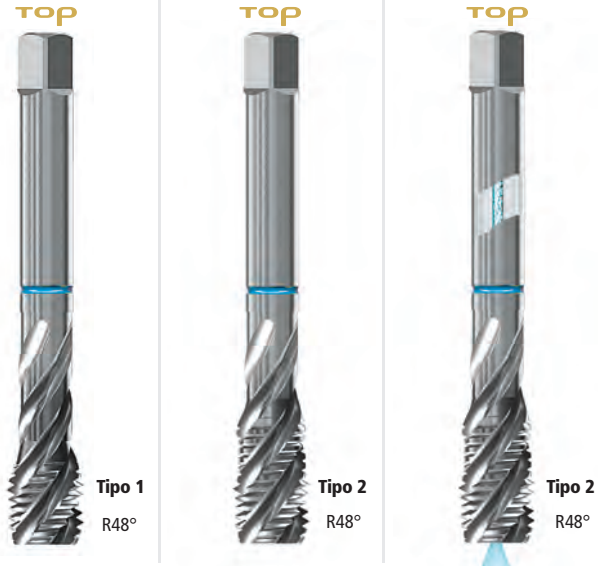

3,5xD	3,5xD	3,5xD
HSSV3	PM3	PM3
6HX	6HX	6HX
TXC	TXC	TXC
1.3 1.4 1.5	1.3 1.4 1.5	1.3 1.4 1.5
2.1 2.2 2.3 2.4	2.1 2.2 2.3 2.4	2.1 2.2 2.3 2.4

CODICE - CODE			
V83MF...TXC			
•			
○			
•			
○			
•			
•			
•			
○			
○			
○			
○			
K83MF...X-TXC	K83MF...XFOR-TXC		
○	○		
○	○		
○	○		
○	○		
○	○		
○	○		
○	○		
○	○		

RACCOMANDATO per filettatura rigida
 We recommend Syncro rigid threading
 Recommandé pour le taraudage rigide

MF

Filettatura metrica ISO passo fine DIN 13

ISO metric fine thread DIN13

Metrisches ISO-Feingewinde DIN 13 – Maschinengewindebohrer
 Filetage métrique ISO à pas fin DIN 13 – Tarauds machine
 Rosca ISO métrica fina DIN 13 – Machos de roscar a máquina



P - SERIES

MASCHI A RULLARE

Roll form taps - Tarauds à refolder

MASCHI A MACCHINA

MACHINE TAPS - TARAUDS MACHINE

DIN 371

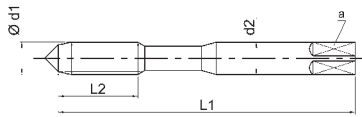

DIN 371

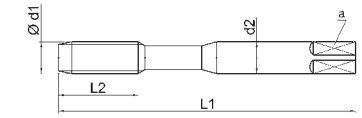

DIN 374

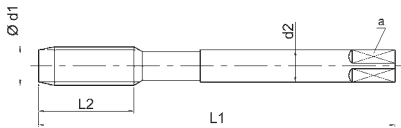

Profond. di filettatura - Thread depth - Profond. de filetage

Materiale - Material - Matériau

Tolleranza - Tolerance - Tolérance

Trattamento superficiale - Surface treatment - Revêtement

Numero gruppi materiali

Material's groups number

Nombre de groupes du matériau

LINE



LINE



LINE



3xD	3xD	3xD
HSSP	HSSP	HSSP
6HX	6HX	6HX
BR	V	TiN
1.1 1.2 1.3	1.1 1.2	1.1 1.2 1.3 1.4
4.1 4.2	4.1 4.2	2.1 2.2 2.3
	5.1 5.2	4.1 4.2 4.3
		5.1 5.2

DIN 371	Ød1 MF	P mm	L1	L2	d2 h9	a h12	Z	
◀	4	0,5	63	13	4,5	3,4	-	3,80
◀	5	0,5	70	13	6	4,9	-	4,80
◀	6	0,75	80	16	6	4,9	-	5,65
◀	8	0,75	90	18	8	6,2	-	7,65
◀	8	1	90	18	8	6,2	-	7,55
◀	10	1	90	15	10	8	-	9,55
◀	10	1,25	100	20	10	8	-	9,40
	8	1	90	18	8	6,2	-	7,55
	10	1	90	15	10	8	-	9,55
	10	1,25	100	20	10	8	-	9,40

CODICE - CODE		
P2SCMF...	P2SCMF...V	P2SCMF...T
○	○	○
○	○	○
○	○	○
○	○	○
●	○	○
●	○	○
●	○	○
P2SCMF...SP	P2SCMF...SP-V	P2SCMF...SP-T
○	○	○
○	○	○
○	○	○

DIN 374	Ød1 MF	P mm	L1	L2	d2 h9	a h12	Z	
	12	1	100	22	9	7	-	11,55
	12	1,25	100	22	9	7	-	11,40
	12	1,5	100	22	9	7	-	11,30
	14	1,25	100	22	11	9	-	13,45
	14	1,5	100	22	11	9	-	13,30
	16	1,5	100	22	12	9	-	15,30

CODICE - CODE		
P2SCMF...	P2SCMF...V	P2SCMF...T
○	○	○
●	○	○
●	○	○
○	○	○
●	○	○
●	○	○

★ Ad esaurimento scorte
 Stock clearance - Stock épuisé

Confezione / Box / Colis:	€ Pag. listino - Price list - Liste des prix	66	67	67
M3 – M10: 10 pezzi / pcs M12 – M16: 5 pezzi / pcs	● Standard	○ Disponibilità da richiedere, prezzo a listino On enquiry, standard price-list / Stock à vérifier	★ Solo a richiesta Only on request / Sur demande	

P - SERIES

MASCHI A RULLARE

Roll form taps - Tarauds à refouler

MASCHI A MACCHINA

MACHINE TAPS - TARAUDS MACHINE

DIN 371

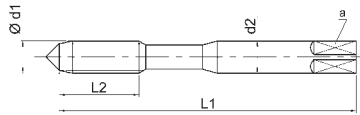

DIN 371

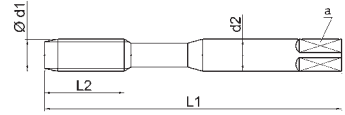

DIN 374

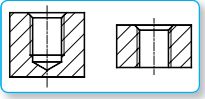
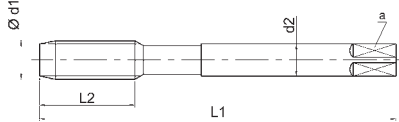

LINE



LINE



LINE



Profond. di filettatura - Thread depth - Profond. de filetage

Materiale - Material - Matériau

Tolleranza - Tolerance - Tolérance

Trattamento superficiale - Surface treatment - Revêtement

Numero gruppi materiali
Material's groups number
Nombre de groupes du matériau

3xD

HSSP

6GX

BR

1.1 1.2 1.3

4.1 4.2

3xD

HSSP

6GX

V

1.1 1.2

4.1 4.2

5.1 5.2

3xD

HSSP

6GX

TiN

1.1 1.2 1.3 1.4

2.1 2.2 2.3

4.1 4.2 4.3

5.1 5.2

DIN 371	Ød1 MF	P mm	L1	L2	d2 h9	a h12	Z	
4	0,5	63	13	4,5	3,4	-	3,80	
5	0,5	70	13	6	4,9	-	4,80	
6	0,75	80	16	6	4,9	-	5,65	
8	0,75	90	18	8	6,2	-	7,65	
8	1	90	18	8	6,2	-	7,55	
10	1	90	15	10	8	-	9,55	
10	1,25	100	20	10	8	-	9,40	
8	1	90	18	8	6,2	-	7,55	
10	1	90	15	10	8	-	9,55	
10	1,25	100	20	10	8	-	9,40	

CODICE - CODE		
P3SCMF...	P3SCMF...V	P3SCMF...T
○	○	○
○	○	○
○	○	○
○	○	○
○	○	○
○	○	○
○	○	○
○	○	○
○	○	○
○	○	○
○	○	○
○	○	○

DIN 374	Ød1 MF	P mm	L1	L2	d2 h9	a h12	Z	
12	1	100	22	9	7	-	11,55	
12	1,25	100	22	9	7	-	11,40	
12	1,5	100	22	9	7	-	11,30	
14	1,25	100	22	11	9	-	13,45	
14	1,5	100	22	11	9	-	13,30	
16	1,5	100	22	12	9	-	15,30	

CODICE - CODE		
P3SCMF...	P3SCMF...V	P3SCMF...T
○	○	○
○	○	○
○	○	○
○	○	○
○	○	○
○	○	○
○	○	○
○	○	○
○	○	○
○	○	○

★ Ad esaurimento scorte
Stock clearance - Stock épuisé

Confezione / Box / Colis:	€ Pag. listino - Price list - Liste des prix	67	67	67
M3 – M10: 10 pezzi / pcs M12 – M16: 5 pezzi / pcs	● Standard	○ Disponibilità da richiedere, prezzo a listino On enquiry, standard price-list / Stock à vérifier	○ Solo a richiesta Only on request / Sur demande	

MASCHI A MACCHINA

MACHINE TAPS - TARAUDS MACHINE

MF

DIN 371

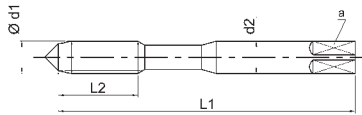

DIN 371

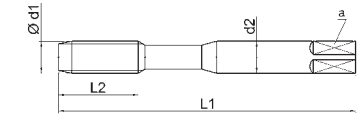

DIN 374

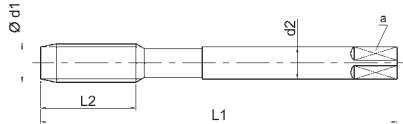

LINE



LINE



LINE



Profond. di filettatura - Thread depth - Profond. de filetage

Materiale - Material - Matériau

Tolleranza - Tolerance - Tolérance

Trattamento superficiale - Surface treatment - Revêtement

Numero gruppi materiali

Material's groups number

Nombre de groupes du matériau

3xD	3xD	3xD
HSSP	HSSP	HSSP
6HX	6HX	6HX
BR	V	TiN
1.1 1.2 1.3	1.1 1.2	1.1 1.2 1.3 1.4
4.1 4.2	4.1 4.2	2.1 2.2 2.3
	5.1 5.2	4.1 4.2 4.3
		5.1 5.2

DIN 371	Ød1 MF	P mm	L1	L2	d2 h9	a h12	Z	
	4	0,5	63	13	4,5	3,4	4	3,80
	5	0,5	70	13	6	4,9	5	4,80
	6	0,75	80	16	6	4,9	5	5,65
	8	0,75	90	18	8	6,2	5	7,65
	8	1	90	18	8	6,2	5	7,55
	10	1	90	15	10	8	5	9,55
	10	1,25	100	20	10	8	5	9,40
	8	1	90	18	8	6,2	5	7,55
	10	1	90	15	10	8	5	9,55
	10	1,25	100	20	10	8	5	9,40

DIN 374	Ød1 MF	P mm	L1	L2	d2 h9	a h12	Z	
	12	1	100	22	9	7	6	11,55
	12	1,25	100	22	9	7	6	11,40
	12	1,5	100	22	9	7	6	11,30
	14	1,25	100	22	11	9	6	13,45
	14	1,5	100	22	11	9	6	13,30
	16	1,5	100	22	12	9	6	15,30
	18	1,5	110	25	14	11	6	17,30
	20	1,5	125	25	16	12	8	19,30

CODICE - CODE		
P2CCMF...	P2CCMF...V	P2CCMF...T
○	○	○
○	○	○
○	○	○
○	○	○
●	○	○
●	○	○
●	○	○
P2CCMF...SP	P2CCMF...SP-V	P2CCMF...SP-T
○	○	○
○	○	○
○	○	○

Ad esaurimento scorte
Stock clearance - Stock épuisé

Confezione / Box / Colis: M3 – M10: 10 pezzi / pcs M12 – M16: 5 pezzi / pcs	€ Pag. listino - Price list - Liste des prix ● Standard	68 ○ Disponibilità da richiedere, prezzo a listino On enquiry, standard price-list / Stock à vérifier	68 ● Solo a richiesta Only on request / Sur demande
---	--	--	--

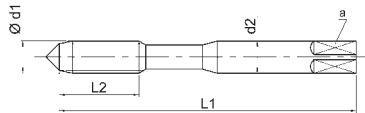
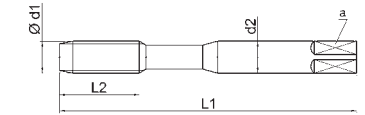
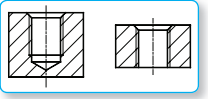
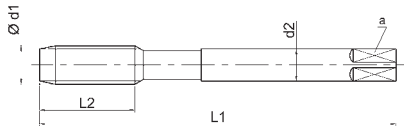
P - SERIES
MASCHI A RULLARE
Roll form taps - Tarauds à refouler
MASCHI A MACCHINA
MACHINE TAPS - TARAUDS MACHINE
DIN 371

DIN 371

DIN 374

LINE

LINE

LINE

MF
Profond. di filettatura - Thread depth - Profond. de filetage
Materiale - Material - Matériau
Tolleranza - Tolerance - Tolérance
Trattamento superficiale - Surface treatment - Revêtement
Numero gruppi materiali
Material's groups number
Nombre de groupes du matériau

3xD	3xD	3xD
HSSP	HSSP	HSSP
6GX	6GX	6GX
BR	V	TiN
1.1 1.2 1.3	1.1 1.2	1.1 1.2 1.3 1.4
4.1 4.2	4.1 4.2	2.1 2.2 2.3
	5.1 5.2	4.1 4.2 4.3
		5.1 5.2

DIN 371	Ød1 MF	P mm	L1	L2	d2 h9	a h12	Z	
◀	4	0,5	63	13	4,5	3,4	4	3,80
◀	5	0,5	70	13	6	4,9	5	4,80
◀	6	0,75	80	16	6	4,9	5	5,65
◀	8	0,75	90	18	8	6,2	5	7,65
◀	8	1	90	18	8	6,2	5	7,55
◀	10	1	90	15	10	8	5	9,55
◀	10	1,25	100	20	10	8	5	9,40
	8	1	90	18	8	6,2	5	7,55
	10	1	90	15	10	8	5	9,55
	10	1,25	100	20	10	8	5	9,40

CODICE - CODE		
P3CCMF...	P3CCMF...V	P3CCMF...T
○	○	○
○	○	○
○	○	○
○	○	○
○	○	○
○	○	○
○	○	○
○	○	○
○	○	○
○	○	○
○	○	○

DIN 374	Ød1 MF	P mm	L1	L2	d2 h9	a h12	Z	
	12	1	100	22	9	7	6	11,55
	12	1,25	100	22	9	7	6	11,40
	12	1,5	100	22	9	7	6	11,30
	14	1,25	100	22	11	9	6	13,45
	14	1,5	100	22	11	9	6	13,30
	16	1,5	100	22	12	9	6	15,30
	18	1,5	110	25	14	11	6	17,30
	20	1,5	125	25	16	12	8	19,30

CODICE - CODE		
P3CCMF...	P3CCMF...V	P3CCMF...T
*	*	*
○	○	○
○	○	○
○	○	○
○	○	○
○	○	○
○	○	○
○	○	○
○	○	○
○	○	○

Ad esaurimento scorte
Stock clearance - Stock épuisé

MF Filettatura metrica ISO passo fine DIN 13

ISO metric fine thread DIN13

Metrisches ISO-Feingewinde DIN 13 – Maschinengewindebohrer
Filetage métrique ISO à pas fin DIN 13 – Tarauds machine
Rosca ISO métrica fina DIN 13 – Machos de roscar a máquina



P - SERIES

MASCHI A RULLARE

Roll form taps - Tarauds à refoiler

MASCHI A MACCHINA

MACHINE TAPS - TARAUDS MACHINE

MF

DIN 371

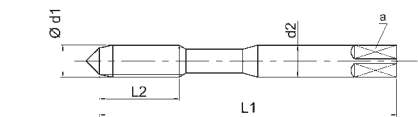

DIN 374

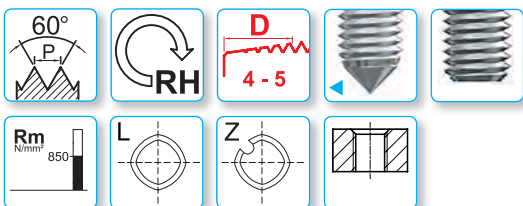
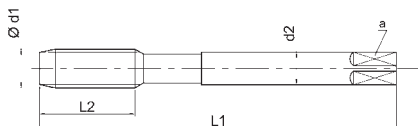

Profond. di filettatura - Thread depth - Profond. de filetage

Materiale - Material - Matériau

Tolleranza - Tolerance - Tolérance

Trattamento superficiale - Surface treatment - Revêtement

Numero gruppi materiali
Material's groups number
Nombre de groupes du matériau



3xD	3xD	3xD	3xD
HSSP	HSSP	HSSP	HSSP
6HX	6HX	6HX	6HX
BR	TiN	BR	TiN
1.1 1.2 1.3	1.1 1.2 1.3 1.4	1.1 1.2 1.3	1.1 1.2 1.3 1.4
4.1 4.2	2.1 2.2 2.3	4.1 4.2	2.1 2.2 2.3
	4.1 4.2 4.3		4.1 4.2 4.3
	5.1 5.2		5.1 5.2

DIN 371	Ød1 MF	P mm	L1	L2	d2 h9	a h12	Z	Icon
8	1	90	18	8	6,2	5	7,55	
10	1	90	15	10	8	5	9,55	
10	1,25	100	20	10	8	5	9,40	

CODICE - CODE			
P2SCMF...FP	P2SCMF...FP-T	P2CCMF...FP	P2CCMF...FP-T
*	*	*	*
*	*	*	*
*	*	*	*

DIN 374	Ød1 MF	P mm	L1	L2	d2 h9	a h12	Z	Icon
12	1	100	22	9	7	6	11,55	
12	1,5	100	22	9	7	6	11,30	
14	1,5	100	22	11	9	6	13,30	
16	1,5	100	22	12	9	6	15,30	
18	1,5	110	25	14	11	6	17,30	
20	1,5	125	25	16	12	8	19,30	

CODICE - CODE			
P2SCMF...FP	P2SCMF...FP-T	P2CCMF...FP	P2CCMF...FP-T
*	*	*	*
*	*	*	*
*	*	*	*
*	*	*	*
*	*	*	*
*	*	*	*

***** Ad esaurimento scorte
Stock clearance - Stock épuisé

Confezione / Box / Colis:
M3 – M10: 10 pezzi / pcs
M12 – M16: 5 pezzi / pcs

€ Pag. listino - Price list - Liste des prix
● Standard

69
○ Disponibilità da richiedere, prezzo a listino
On enquiry, standard price-list / Stock à vérifier

69
★ Solo a richiesta
Only on request / Sur demande

P - SERIES
MASCHI A RULLARE

Roll form taps - Tarauds à refouler

MASCHI A MACCHINA, FILETTATURA SINISTRA

LEFT THREAD MACHINE TAPS - TARAUDS MACHINE GAUCHE

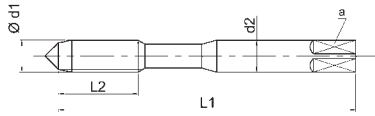
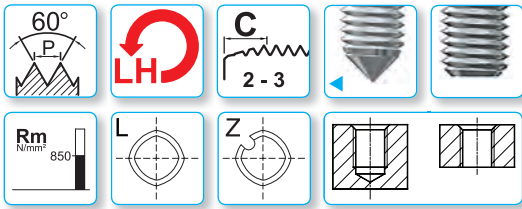
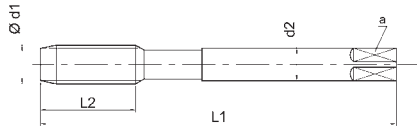
DIN 371

DIN 374

LINE



LINE



LINE



LINE



MF

Profond. di filettatura - Thread depth - Profond. de filetage

Materiale - Material - Matériau

Tolleranza - Tolerance - Tolérance

Trattamento superficiale - Surface treatment - Revêtement

Numero gruppi materiali

Material's groups number

Nombre de groupes du matériau

3xD
HSSP
6HX
BR

1.1 1.2 1.3

4.1 4.2

3xD
HSSP
6HX
TiN

1.1 1.2 1.3 1.4

2.1 2.2 2.3

4.1 4.2 4.3

5.1 5.2

3xD
HSSP
6HX
BR

1.1 1.2 1.3

4.1 4.2

3xD
HSSP
6HX
TiN

1.1 1.2 1.3 1.4

2.1 2.2 2.3

4.1 4.2 4.3

5.1 5.2

DIN 371	$\varnothing d1$ MF	P mm	L ₁	L ₂	d ₂ h ₉	a h ₁₂	Z	
◀	8	1	90	18	8	6,2	5	7,55
◀	10	1	90	15	10	8	5	9,55
◀	10	1,25	100	20	10	8	5	9,40

CODICE - CODE			
P2SCMF...LH	P2SCMF...LH-T	P2CCMF...LH	P2CCMF...LH-T
<input type="radio"/>	<input type="radio"/>	<input type="radio"/>	<input type="radio"/>
<input type="radio"/>	<input type="radio"/>	<input type="radio"/>	<input type="radio"/>
<input type="radio"/>	<input type="radio"/>	<input type="radio"/>	<input type="radio"/>

DIN 374	$\varnothing d1$ MF	P mm	L ₁	L ₂	d ₂ h ₉	a h ₁₂	Z	
	12	1	100	22	9	7	6	11,55
	12	1,5	100	22	9	7	6	11,30
	14	1,5	100	22	11	9	6	13,30
	16	1,5	100	22	12	9	6	15,30
	18	1,5	110	25	14	11	6	17,30
	20	1,5	125	25	16	12	8	19,30

CODICE - CODE			
P2SCMF...LH	P2SCMF...LH-T	P2CCMF...LH	P2CCMF...LH-T
<input type="radio"/>	<input type="radio"/>	<input type="radio"/>	<input type="radio"/>
<input type="radio"/>	<input type="radio"/>	<input type="radio"/>	<input type="radio"/>
<input type="radio"/>	<input type="radio"/>	<input type="radio"/>	<input type="radio"/>
<input type="radio"/>	<input type="radio"/>	<input type="radio"/>	<input type="radio"/>
<input type="radio"/>	<input type="radio"/>	<input type="radio"/>	<input type="radio"/>
<input type="radio"/>	<input type="radio"/>	<input type="radio"/>	<input type="radio"/>

Confezione / Box / Colis: M3 – M10: 10 pezzi / pcs M12 – M16: 5 pezzi / pcs	€ Pag. listino - Price list - Liste des prix	69	69	69	69
● Standard	○ Disponibilità da richiedere, prezzo a listino On enquiry, standard price-list / Stock à vérifier			★ Solo a richiesta Only on request / Sur demande	

MF Filettatura metrica ISO passo fine DIN 13

ISO metric fine thread DIN13
Metrisches ISO-Feingewinde DIN 13 – Maschinengewindebohrer
Filetage métrique ISO à pas fin DIN 13 – Tarauds machine
Rosca ISO métrica fina DIN 13 – Machos de rosca a máquina



X - SERIES

MASCHI A RULLARE
Roll form taps - Tarauds à refouler

MASCHI A MACCHINA

MACHINE TAPS - TARAUDS MACHINE

DIN 371

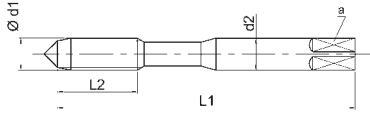

DIN 374

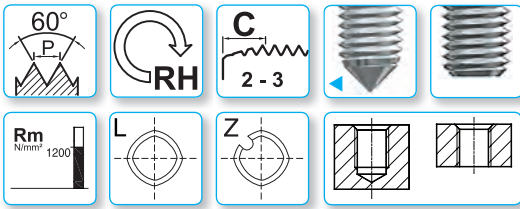
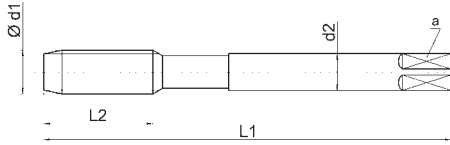

Profond. di filettatura - Thread depth - Profond. de filetage

Materiale - Material - Matériau

Tolleranza - Tolerance - Tolérance

Trattamento superficiale - Surface treatment - Revêtement

Numero gruppi materiali
Material's groups number
Nombre de groupes du matériau

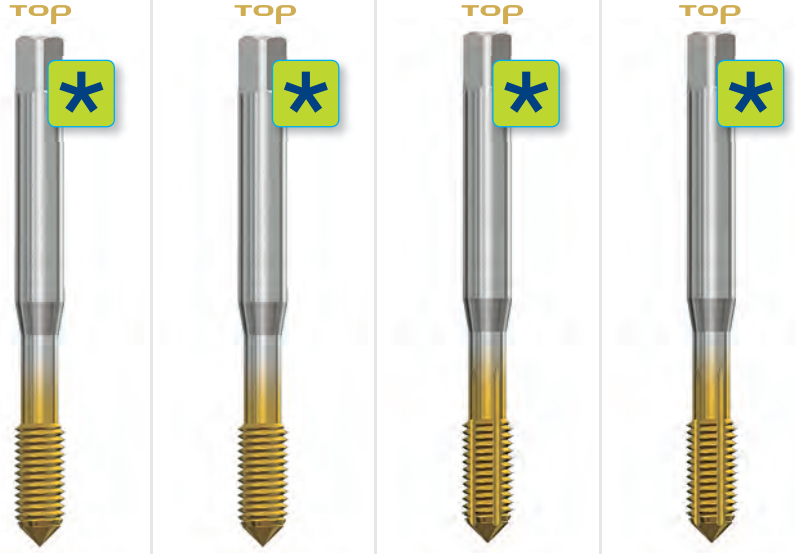

3xD	3xD	3xD	3xD
PM3	PM3	PM3	PM3
6HX	6GX	6HX	6GX
TiN-G	TiN-G	TiN-G	TiN-G
1.1 1.2 1.3 1.4 1.5	1.1 1.2 1.3 1.4 1.5	1.1 1.2 1.3 1.4 1.5	1.1 1.2 1.3 1.4 1.5
2.1 2.2 2.3 2.4	2.1 2.2 2.3 2.4	2.1 2.2 2.3 2.4	2.1 2.2 2.3 2.4
4.1 4.2 4.3	4.1 4.2 4.3	4.1 4.2 4.3	4.1 4.2 4.3
5.1 5.2 7.1 7.2	5.1 5.2 7.1 7.2	5.1 5.2 7.1 7.2	5.1 5.2 7.1 7.2

DIN 371	Ød1 MF	P mm	L1	L2	d2 h9	a h12	Z	
4	0,5	63	13	4,5	3,4	4	3,75	
5	0,5	70	13	6	4,9	5	4,75	
6	0,75	80	16	6	4,9	5	5,65	
8	1	90	18	8	6,2	5	7,55	
10	1	90	15	10	8	5	9,55	
10	1,25	100	20	10	8	5	9,45	

CODICE - CODE			
X2SCMF...TG	X3SCMF...TG	X2CCMF...TG	X3CCMF...TG
<input type="checkbox"/>	<input type="checkbox"/>	<input type="checkbox"/>	<input type="checkbox"/>
<input type="checkbox"/>	<input type="checkbox"/>	<input type="checkbox"/>	<input type="checkbox"/>
<input type="checkbox"/>	<input type="checkbox"/>	<input type="checkbox"/>	<input type="checkbox"/>
<input type="checkbox"/>	<input type="checkbox"/>	<input type="checkbox"/>	<input type="checkbox"/>
<input type="checkbox"/>	<input type="checkbox"/>	<input type="checkbox"/>	<input type="checkbox"/>
<input type="checkbox"/>	<input type="checkbox"/>	<input type="checkbox"/>	<input type="checkbox"/>

DIN 374	Ød1 MF	P mm	L1	L2	d2 h9	a h12	Z	
12	1	100	22	9	7	6	11,55	
12	1,25	100	22	9	7	6	11,45	
12	1,5	100	22	9	7	6	11,30	
14	1,25	100	22	11	9	6	13,45	
14	1,5	100	22	11	9	6	13,30	
16	1,5	100	22	12	9	6	15,30	

CODICE - CODE			
X2SCMF...TG	X3SCMF...TG	X2CCMF...TG	X3CCMF...TG
<input type="checkbox"/>	<input type="checkbox"/>	<input type="checkbox"/>	<input type="checkbox"/>
<input type="checkbox"/>	<input type="checkbox"/>	<input type="checkbox"/>	<input type="checkbox"/>
<input type="checkbox"/>	<input type="checkbox"/>	<input type="checkbox"/>	<input type="checkbox"/>
<input type="checkbox"/>	<input type="checkbox"/>	<input type="checkbox"/>	<input type="checkbox"/>
<input type="checkbox"/>	<input type="checkbox"/>	<input type="checkbox"/>	<input type="checkbox"/>
<input type="checkbox"/>	<input type="checkbox"/>	<input type="checkbox"/>	<input type="checkbox"/>

***** Ad esaurimento scorte
Stock clearance - Stock épuisé

Vedi nuova serie - See new series - Voir nouvelle série
K-ROLL pag. XXXVIII

Confezione / Box / Colis:	€ Pag. listino - Price list - Liste des prix	70	70	70	70
M3 - M10: 10 pezzi / pcs M12 - M16: 5 pezzi / pcs	• Standard	<input type="checkbox"/> Disponibilità da richiedere, prezzo a listino On enquiry, standard price-list / Stock à vérifier	<input type="checkbox"/> Solo a richiesta Only on request / Sur demande		

X - SERIES

MASCHI A RULLARE

Roll form taps - Tarauds à refouler

MASCHI A MACCHINA

MACHINE TAPS - TARAUDS MACHINE

DIN 371

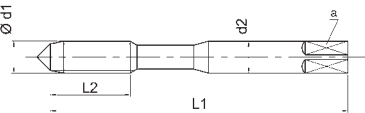

DIN 371

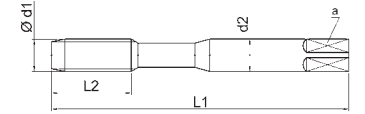

DIN 374

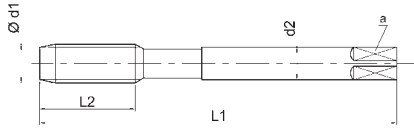

TOP



TOP



TOP



Profond. di filettatura - Thread depth - Profond. de filetage

Materiale - Material - Matériau

Tolleranza - Tolerance - Tolérance

Trattamento superficiale - Surface treatment - Revêtement

Numero gruppi materiali

Material's groups number

Nombre de groupes du matériau

3xD

PM3

6HX

TXC

1.1 1.2

4.1 4.2 4.3

5.1 5.2

3xD

PM3

6HX

TiN-G

1.1 1.2 1.3 1.4 1.5

2.1 2.2 2.3 2.4

4.1 4.2 4.3

5.1 5.2 7.1 7.2

3xD

PM3

6HX

TiN-G

1.1 1.2 1.3 1.4 1.5

2.1 2.2 2.3 2.4

4.1 4.2 4.3

5.1 5.2 7.1 7.2

DIN 371	Ød1 MF	P mm	L1	L2	d2 h9	a h12	Z	
◀	8	1	90	18	8	6,2	5	7,55
◀	10	1	90	15	10	8	5	9,55
◀	10	1,25	100	20	10	8	5	9,45
	8	1	90	18	8	6,2	5	7,55
	10	1	90	15	10	8	5	9,55
	10	1,25	100	20	10	8	5	9,45
◀	8	1	90	18	8	6,2	2	7,55
◀	10	1	90	15	10	8	2	9,55
◀	10	1,25	100	20	10	8	2	9,45

CODICE - CODE	
X2CCMF...TXC	
○	
○	
○	
	X2CCMF...FOR-TG
-	○
-	○
-	○
	X2CCMF...FORY-TG
-	○ 4L/Z2
-	○ 4L/Z2
-	○ 4L/Z2

DIN 374	Ød1 MF	P mm	L1	L2	d2 h9	a h12	Z	
	12	1	100	22	9	7	6	11,55
	12	1,25	100	22	9	7	6	11,45
	12	1,5	100	22	9	7	6	11,30
	14	1,5	100	22	11	9	6	13,30
	16	1,5	100	22	12	9	6	15,30
	12	1	100	22	9	7	3	11,55
	12	1,25	100	22	9	7	3	11,45
	12	1,5	100	22	9	7	3	11,30
	14	1,5	100	22	11	9	3	13,30
	16	1,5	100	22	12	9	3	15,30

CODICE - CODE	
X2CCMF...TXC	X2CCMF...FOR-TG
○	○
○	○
○	○
○	○
○	○
	X2CCMF...FORY-TG
-	○ 6L/Z3
-	○ 6L/Z3
-	○ 6L/Z3
-	○ 6L/Z3
-	○ 6L/Z3

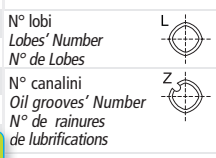

★ Ad esaurimento scorte
Stock clearance - Stock épuisé

Vedi nuova serie - See new series
Voir nouvelle série: K-ROLL pag. XXXIX

Confezione / Box / Colis: M3 - M10: 10 pezzi / pcs M12 - M16: 5 pezzi / pcs	€ Pag. listino - Price list - Liste des prix	70	70	70
● Standard	○ Disponibilità da richiedere, prezzo a listino On enquiry, standard price-list / Stock à vérifier			★ Solo a richiesta Only on request / Sur demande

MF Filettatura metrica ISO passo fine DIN 13

ISO metric fine thread DIN13
 Metrisches ISO-Feingewinde DIN 13 – Maschinengewindebohrer
 Filetage métrique ISO à pas fin DIN 13 – Tarauds machine
 Rosca ISO métrica fina DIN 13 – Machos de roscar a máquina



X - SERIES

MASCHI A RULLARE
 Roll form taps - Tarauds à refouler

MASCHI A MACCHINA

MACHINE TAPS - TARAUDS MACHINE

MF

DIN 371

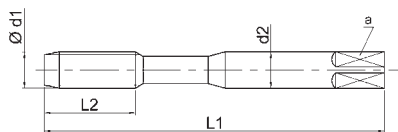

DIN 374

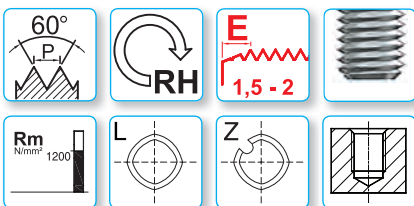
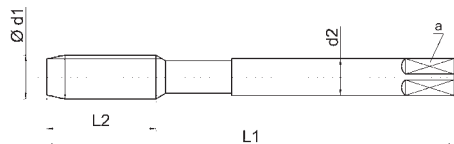

Profond. di filettatura - Thread depth - Profond. de filetage

Materiale - Material - Matériau

Tolleranza - Tolerance - Tolérance

Trattamento superficiale - Surface treatment - Revêtement

Numero gruppi materiali
 Material's groups number
 Nombre de groupes du matériau

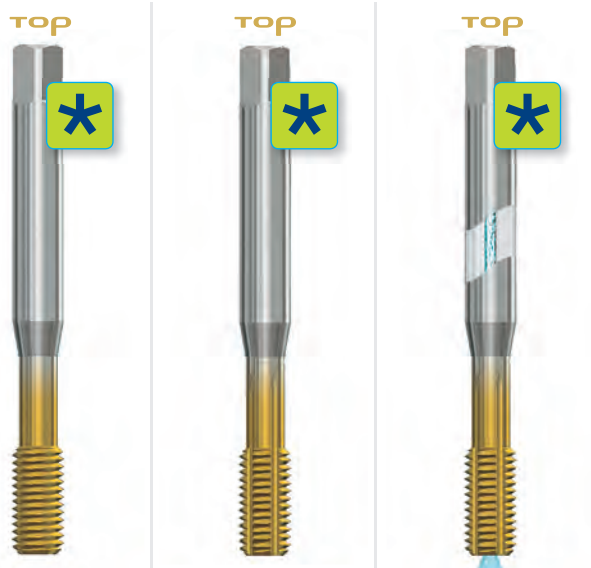

3xD	3xD	3xD
PM3	PM3	PM3
6HX	6HX	6HX
TiN-G	TiN-G	TiN-G
1.1 1.2 1.3 1.4 1.5	1.1 1.2 1.3 1.4 1.5	1.1 1.2 1.3 1.4 1.5
2.1 2.2 2.3 2.4	2.1 2.2 2.3 2.4	2.1 2.2 2.3 2.4
4.1 4.2 4.3	4.1 4.2 4.3	4.1 4.2 4.3
5.1 5.2 7.1 7.2	5.1 5.2 7.1 7.2	5.1 5.2 7.1 7.2

DIN 371	Ød1	P	L1	L2	d2	a	Z	
MF	mm				h9	h12		
8	1	90	18	8	6,2	5	7,55	
10	1	90	15	10	8	5	9,55	
10	1,25	100	20	10	8	5	9,45	

CODICE - CODE		
X2SCEMF...TG	X2CCEMF...TG	X2CCEMF...FOR-TG
○	○	○
○	○	○
○	○	○

DIN 374	Ød1	P	L1	L2	d2	a	Z	
MF	mm				h9	h12		
12	1	100	22	9	7	6	11,55	
12	1,25	100	22	9	7	6	11,45	
12	1,5	100	22	9	7	6	11,30	
14	1,5	100	22	11	9	6	13,30	
16	1,5	100	22	12	9	6	15,30	

CODICE - CODE		
X2SCEMF...TG	X2CCEMF...TG	X2CCEMF...FOR-TG
○	○	○
○	○	○
○	○	○
○	○	○
○	○	○

***** Ad esaurimento scorte
 Stock clearance - Stock épuisé

Vedi nuova serie - See new series - Voir nouvelle série
 K-ROLL pag. XL

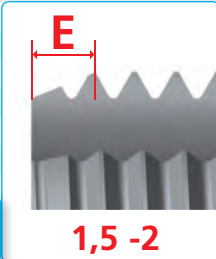

Confezione / Box / Colis: M3 – M10: 10 pezzi / pcs M12 – M16: 5 pezzi / pcs	€ Pag. listino - Price list - Liste des prix	71	71	71
● Standard	○ Disponibilità da richiedere, prezzo a listino On enquiry, standard price-list / Stock à vérifier	★ Solo a richiesta Only on request / Sur demande		

UNI 5870 - ISO 1502

LINE

MF

Calibri a tampone filettati passa / non passa

Thread plug gauges go/no-go

Calibres de filetage entre/n'entre pas



Tolleranza - Tolerance - Tolérance

6H

Trattamento superficiale - Surface treatment - Revêtement

BR

Ød1 MF	P mm	CODICE - CODE P-NPMF...
4	0,5	○
5	0,5	○
6	0,75	○
7	0,75	○
8	0,75	○
8	1	○
9	1	○
10	0,75	○
10	1	○
10	1,25	○
12	1	○
12	1,25	○
12	1,5	○
14	1	○
14	1,25	○
14	1,5	○
16	1	○
16	1,5	○
18	1	○
18	1,5	○
18	2	○
20	1	○
20	1,5	○
20	2	○
22	1	○
22	1,5	○
24	1	○
24	1,5	○
24	2	○
25	1	○
25	1,5	○
25	2	○
26	1,5	○
26	2	○

 Segue diametri
 Diameters, to be continued / Diamètres à suivre ▶ Pag. 148

 Confezione: Singola
 Box: Single
 Colis: Unique

€ Pag. listino - Price list - Liste des prix

108

● Standard

 ○ Disponibilità da richiedere, prezzo a listino
 On enquiry, standard price-list / Stock à vérifier

 ★ Solo a richiesta
 Only on request / Sur demande

CALIBRI FILETTATI

THREAD GAUGES - CALIBRES DE FILETAGE

UNI 5870 - ISO 1502

Calibri a tampone filettati passa / non passa

Thread plug gauges go/no-go

Calibres de filetage entre/n'entre pas



Tolleranza - Tolerance - Tolérance

6H

Trattamento superficiale - Surface treatment - Revêtement

BR

Ød1 MF	P mm	CODICE - CODE P-NPMF...
27	1	○
27	1,5	○
28	1,5	○
28	2	○
30	1	○
30	1,5	○
30	2	○
32	1	○
32	1,5	○
32	2	○
33	2	○
35	1,5	○
35	2	○
36	1,5	○
36	2	○
36	3	○
38	1,5	○
39	2	○
40	1,5	○
40	2	○
40	3	○
42	1,5	○
42	2	○
42	3	○
45	1,5	○
45	2	○
45	3	○
48	1,5	○
48	2	○
48	3	○
50	1,5	○
50	2	○
50	3	○

Confezione / Box / Colis:
M3 – M10: 10 pezzi / pcs
M12 – M16: 5 pezzi / pcs

€ Pag. listino - Price list - Liste des prix

108

● Standard

○ Disponibilità da richiedere, prezzo a listino
On enquiry, standard price-list / Stock à vérifier

★ Solo a richiesta
Only on request / Sur demande

UNC



UNC

MASCHI A MANO

HAND TAPS - TARAUDS MAIN

DIN 352

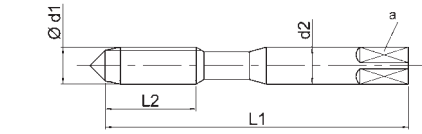

DIN 352

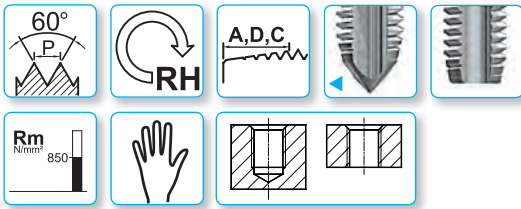
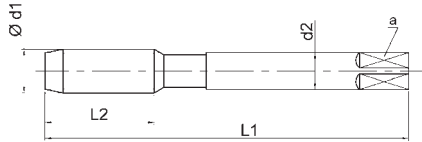

LINE

LINE

LINE

LINE



A 5-6

D 4-5

C 2-3

Profond. di filettatura - Thread depth - Profond. de filetage

Materiale - Material - Matériau

Tolleranza - Tolerance - Tolérance

Trattamento superficiale - Surface treatment - Revêtement

Numero gruppi materiali
Material's groups number
Nombre de groupes du matériau

2xD	2xD	2xD	2xD
HSS	HSS	HSS	HSS
-	-	2B	2B
BR	BR	BR	BR
1.1 1.2 1.3 1.4	1.1 1.2 1.3 1.4	1.1 1.2 1.3 1.4	1.1 1.2 1.3 1.4
2.1 2.2 2.3 3.1 3.4	2.1 2.2 2.3 3.1 3.4	2.1 2.2 2.3 3.1 3.4	2.1 2.2 2.3 3.1 3.4
4.1 4.2 4.3 4.4	4.1 4.2 4.3 4.4	4.1 4.2 4.3 4.4	4.1 4.2 4.3 4.4
5.1 5.2 5.3	5.1 5.2 5.3	5.1 5.2 5.3	5.1 5.2 5.3

DIN 352	Ød1 UNC	P TPI	Ø mm	L1	L2	d2 h9	a h12	Z	
6	32	3,505	45	10	4	3	3	2,85	
8	32	4,166	45	11	4,5	3,4	3	3,5	
10	24	4,826	50	13	6	4,9	3	3,9	
12	24	5,486	56	15	6	4,9	3	4,5	
1/4	20	6,350	56	16	6	4,9	3	5,1	
5/16	18	7,938	63	19	6	4,9	3	6,6	
3/8	16	9,525	70	22	7	5,5	3	8	
7/16	14	11,113	70	22	8	6,2	3	9,4	
1/2	13	12,700	75	28	9	7	3	10,8	
9/16	12	14,288	80	30	11	9	4	12,2	
5/8	11	15,875	80	30	12	9	4	13,5	
3/4	10	19,050	95	34	14	11	4	16,5	
7/8	9	22,225	100	34	18	14,5	4	19,5	
1"	8	25,400	110	38	18	14,5	4	22,25	
1 1/8	7	28,575	125	45	22	18	4	25	
1 1/4	7	31,750	125	45	22	18	4	28	
1 3/8	6	34,925	150	55	28	22	4	30,75	
1 1/2	6	38,100	150	55	28	22	4	34	
1 3/4	5	44,450	160	60	36	29	5	39,5	
2"	4 1/2	50,800	180	65	40	32	5	45	

★ Ad esaurimento scorte
Stock clearance - Stock épuisé

CODICE - CODE			
01UNC...	02UNC...	03UNC...	00UNC...
○	○	○	○
○	○	○	○
○	○	○	○
○	○	○	○
○	○	○	●
○	○	○	●
○	○	○	●
○	○	○	●
○	○	○	○
○	○	○	○
○	○	○	○
○	○	○	○
○	○	○	○
○	○	○	○
○	○	○	○
○	○	○	○
○	○	○	○
○	○	○	○
○	○	○	○
○	○	○	○
○	○	○	○
○	○	○	○
○	○	○	○
○	○	○	○
○	○	○	○
○	○	○	○
○	○	○	○

Confezione: Singola Box: Single Collis: Unique	€ Pag. listino - Price list - Liste des prix	72	72	72	72
● Standard	○ Disponibilità da richiedere, prezzo a listino On enquiry, standard price-list / Stock à vérifier	★ Solo a richiesta Only on request / Sur demande			

N **USO GENERALE**
 General purpose - Usage Général

MASCHI A MACCHINA
 MACHINE TAPS - TARAUDS MACHINE

DIN 371

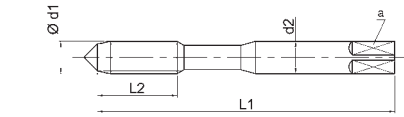

DIN 376

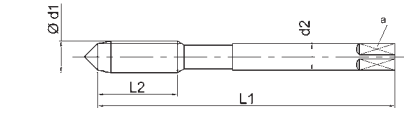

DIN 376

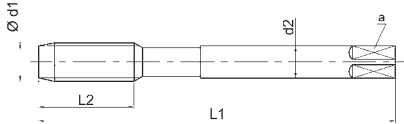

LINE



LINE

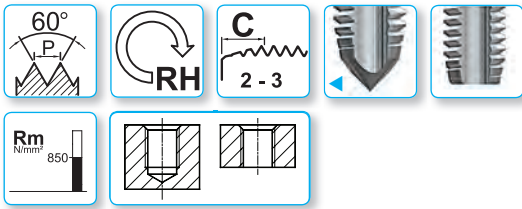

Profond. di filettatura - Thread depth - Profond. de filetage
Materiale - Material - Matériau
Tolleranza - Tolerance - Tolérance
Trattamento superficiale - Surface treatment - Revêtement

1,5xD	1,5xD
HSSE	HSSE
2B	2B
BR	TiN
1.1 1.2 1.3 1.4 3.4	1.1 1.2 1.3 1.4 3.4
4.2 4.3 5.2 5.3	4.2 4.3 5.2 5.3
8.2	8.2

Numero gruppi materiali
 Material's groups number
 Nombre de groupes du matériau

DIN 371	Ød1 UNC	P TPI	Ø mm	L ₁	L ₂	d ₂ h9	a h12	Z	
◀	6	32	3,505	56	11	4	3	3	2,85
◀	8	32	4,166	63	13	4,5	3,4	3	3,5
◀	10	24	4,826	70	13	6	4,9	3	3,9
◀	12	24	5,486	80	16	6	4,9	3	4,5
◀	1/4	20	6,350	80	16	7	5,5	3	5,1
◀	5/16	18	7,938	90	18	8	6,2	3	6,6
◀	3/8	16	9,525	100	20	10	8	3	8

CODICE - CODE	
E20UNC...	E20UNC...T
•	○
•	○
•	○
○	○
•	○
○	○
○	○

DIN 376	Ød1 UNC	P TPI	Ø mm	L ₁	L ₂	d ₂ h9	a h12	Z	
◀	1/4	20	6,350	80	16	4,5	3,4	3	5,1
◀	5/16	18	7,938	90	18	6	4,9	3	6,6
◀	3/8	16	9,525	100	20	7	5,5	3	8
	7/16	14	11,113	100	20	8	6,2	3	9,4
	1/2	13	12,700	110	25	9	7	3	10,8
	9/16	12	14,288	110	28	11	9	3	12,2
	5/8	11	15,875	110	28	12	9	3	13,5
	3/4	10	19,050	125	32	14	11	4	16,5
	7/8	9	22,225	140	32	18	14,5	4	19,5
	1"	8	25,400	160	36	18	14,5	4	22,25
	1"1/8	7	28,575	180	46	22	18	4	25
	1"1/4	7	31,750	180	46	22	18	4	28
	1"3/8	6	34,925	200	50	28	22	4	30,75
	1"1/2	6	38,100	200	50	28	22	4	34
■	1"3/4	5	44,450	220	60	36	29	5	39,5
■	2"	4 1/2	50,800	250	65	40	32	5	45

CODICE - CODE	
E21UNC...	E21UNC...T
○	○
•	○
•	○
•	○
•	○
○	○
•	○
•	○
○	○
○	○
○	○
○	○
○	○
○	○
○	○

■ = Acciaio HSS
 HSS Steel / Acier HSS

Confezione: Singola
 Box: Single
 Colis: Unique

€ Pag. listino - Price list - Liste des prix **72** **73**

• Standard ○ Disponibilità da richiedere, prezzo a listino
 On enquiry, standard price-list / Stock à vérifier

★ Solo a richiesta
 Only on request / Sur demande

UNC

Filettatura americana UNC passo grosso ASME B1.1

UNC coarse thread ASME B1.1

Unified Grobgewinde UNC ASME B1.1 – Maschinengewindebohrer

Filetage américain UNC ASME B1.1 – Tarauds machine

Rosca gruesa UNC ASME B1.1 – Machos de rosar a máquina



GHISA
Cast Iron - Fonte

MASCHI A MACCHINA MACHINE TAPS

DIN 371

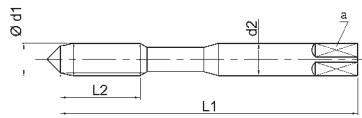

DIN 371

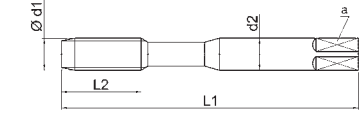

DIN 376

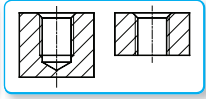
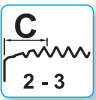
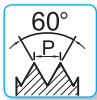
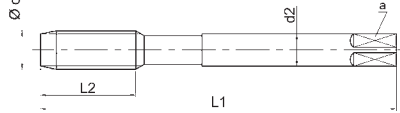

LINE



LINE



TOP



TOP



Profond. di filettatura - Thread depth - Profond. de filetage

Materiale - Material - Matériau

Tolleranza - Tolerance - Tolérance

Trattamento superficiale - Surface treatment - Revêtement

Al Si>10%,
Ottone / Brass / Laiton
Bronzo / Bronze / Bronze
truciolo corto / short chip /
coupeaux courts

Numero gruppi materiali
Material's groups number
Nombre de groupes du matériau

3xD	3xD	3xD	3,5xD
HSSE	HSSE	PM3	PM3
2BX	2BX	2BX	2BX
NQ	TiCN	TiAlN	TiAlN
3.1 3.2 3.3 3.4 3.5	3.1 3.2 3.3 3.4 3.5	3.1 3.2 3.3 3.4 3.5	3.1 3.2 3.3 3.4 3.5
4.3 4.4 4.5 4.6 5.3	4.3 4.4 4.5 4.6 5.3	4.4 5.3 5.4	4.4 5.3 5.4
8.2 10.1	8.2 10.1	10.1	10.1

DIN 371	Ød1 UNC	P TPI	Ø mm	L1	L2	d2 h9	a h12	Z	Thread
6	32	3,505	56	11	4	3	3	2,85	▶
8	32	4,166	63	13	4,5	3,4	3	3,5	▶
10	24	4,826	70	13	6	4,9	3	3,9	▶
12	24	5,486	80	16	6	4,9	3	4,5	▶
1/4	20	6,350	80	16	7	5,5	3	5,1	▶
1/4	20	6,350	80	16	7	5,5	4	5,1	▶
5/16	18	7,938	90	18	8	6,2	4	6,6	▶
3/8	16	9,525	100	20	10	8	4	8	▶
1/4	20	6,350	80	16	7	5,5	3	5,1	▶
1/4	20	6,350	80	16	7	5,5	4	5,1	▶

CODICE - CODE			
E26UNC...NQ	E26UNC...CT	K26UNC...TX	
*	o	-	
*	o	-	
*	●	-	
*	o	-	
*	●	-	
-	-	o	
-	-	o	
-	-	o	
E26UNC...SP-NQ	E26UNC...SP-CT	K26UNC...SP-TX	K26UNC...FOR-TX
*	o	-	-
-	-	o	o

DIN 376	Ød1 UNC	P TPI	Ø mm	L1	L2	d2 h9	a h12	Z	Thread
5/16	18	7,938	90	18	6	4,9	4	6,6	▶
3/8	16	9,525	100	20	7	5,5	4	8	▶
7/16	14	11,113	100	20	8	6,2	4	9,4	▶
1/2	13	12,700	110	25	9	7	4	10,8	▶
9/16	12	14,288	110	28	11	9	4	12,2	▶
5/8	11	15,875	110	28	12	9	4	13,5	▶
3/4	10	19,050	125	32	14	11	4	16,5	▶
7/8	9	22,225	140	32	18	14,5	4	19,5	▶
1"	8	25,400	160	36	18	14,5	4	22,25	▶
3/4	10	19,050	125	32	14	11	5	16,5	▶
7/8	9	22,225	140	32	18	14,5	5	19,5	▶
1"	8	25,400	160	36	18	14,5	5	22,25	▶

CODICE - CODE			
E27UNC...NQ	E27UNC...CT	K27UNC...TX	K27UNC...FOR-TX
*	●	-	-
*	●	-	-
*	●	o	o
*	●	o	o
*	o	o	o
*	o	o	o
*	o	-	-
*	o	-	-
*	o	-	-
*	o	-	-
		o	o
		o	o
		o	o

Confezione / Box / Colis:
6 - 7/16: 10 pezzi / pcs
1/2 - 9/16: 5 pezzi / pcs
>9/16: singoli / single pcs

€ Pag. listino - Price list - Liste des prix

73

73

73

73

• Standard

o Disponibilità da richiedere, prezzo a listino
On enquiry, standard price-list / Stock à vérifier

* Solo a richiesta
Only on request / Sur demande

N **USO GENERALE**
General purpose

MASCHI A MACCHINA MACHINE TAPS

DIN 371

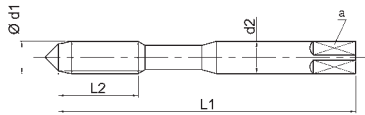

DIN 376

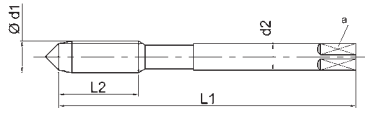

DIN 376

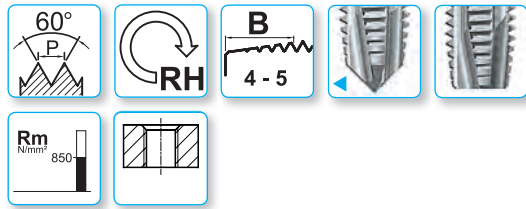
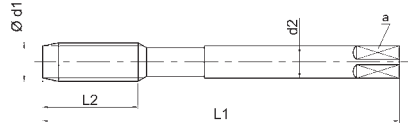

LINE



LINE



LINE



LINE



UNC

Profond. di filettatura - Thread depth - Profond. de filetage
 Materiale - Material - Matériau
 Tolleranza - Tolerance - Tolérance
 Trattamento superficiale - Surface treatment - Revêtement
 Numero gruppi materiali
 Material's groups number
 Nombre de groupes du matériau

3xD	3xD	3xD	3xD
HSSE	HSSE	HSSE	HSSE
2B	2B	2B	2B
BR	V	TiN	XP
1.1 1.2 1.3 1.4	1.1 1.2 1.3 1.4	1.1 1.2 1.3 1.4	1.1 1.2 1.3 1.4
4.1 4.2	4.1 4.2	3.3 3.4	2.1 2.2 3.3 3.4
5.1 5.2	5.1 5.2	4.1 4.2 4.3	4.2 4.3
	6.1 7.1	5.1 5.2	5.2

DIN 371	Ød1 UNC	P TPI	Ø mm	L ₁	L ₂	d ₂ h9	a h12	Z	
◀	6	32	3,505	56	11	4	3	3	2,85
◀	8	32	4,166	63	13	4,5	3,4	3	3,5
◀	10	24	4,826	70	13	6	4,9	3	3,9
◀	12	24	5,486	80	16	6	4,9	3	4,5
◀	1/4	20	6,350	80	16	7	5,5	3	5,1
◀	5/16	18	7,938	90	18	8	6,2	3	6,6
◀	3/8	16	9,525	100	20	10	8	3	8

CODICE - CODE			
E24UNC...	E24UNC...V	E24UNC...T	E24UNC...XP
•	○	○	○
•	○	○	○
•	○	○	○
○	○	○	○
•	○	○	○
○	○	○	○
○	○	○	○

DIN 376	Ød1 UNC	P TPI	Ø mm	L ₁	L ₂	d ₂ h9	a h12	Z	
◀	1/4	20	6,350	80	16	4,5	3,4	3	5,1
◀	5/16	18	7,938	90	18	6	4,9	3	6,6
◀	3/8	16	9,525	100	20	7	5,5	3	8
	7/16	14	11,113	100	20	8	6,2	3	9,4
	1/2	13	12,700	110	25	9	7	3	10,8
	9/16	12	14,288	110	28	11	9	3	12,2
	5/8	11	15,875	110	28	12	9	3	13,5
	3/4	10	19,050	125	32	14	11	4	16,5
	7/8	9	22,225	140	32	18	14,5	4	19,5
	1"	8	25,400	160	36	18	14,5	4	22,25
	1"1/8	7	28,575	180	46	22	18	4	25
	1"1/4	7	31,750	180	46	22	18	4	28
	1"3/8	6	34,925	200	50	28	22	4	30,75
	1"1/2	6	38,100	200	50	28	22	4	34
■	1"3/4	5	44,450	220	60	36	29	5	39,5
■	2"	4 1/2	50,800	250	65	40	32	5	45

CODICE - CODE			
E25UNC...	E25UNC...V	E25UNC...T	E25UNC...XP
○	○	○	○
•	○	○	○
•	○	○	○
•	○	○	○
•	○	○	○
○	○	○	○
•	○	○	○
•	○	○	○
○	○	○	○
•	○	○	○
○	○	○	○
○	○	○	○
○	○	○	○
○	○	○	○
○	○	○	○
○	○	○	○
○	○	○	○
○	○	○	○
○	○	○	○

■ = Acciaio HSS / HSS Steel / Acier HSS
 Confezione / Box / Collis:
 6 – 7/16: 10 pezzi / pcs
 1/2 – 9/16: 5 pezzi / pcs
 >9/16: singoli / single pcs

€ Pag. listino - Price list - Liste des prix

74	74	74	74
----	----	----	----

● Standard ○ Disponibilità da richiedere, prezzo a listino
 On enquiry, standard price-list / Stock à vérifier ★ Solo a richiesta
 Only on request / Sur demande

MASCHI A MACCHINA

MACHINE TAPS - TARAUDS MACHINE

DIN 371

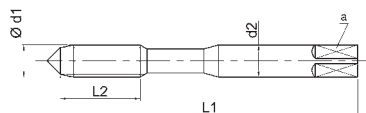

DIN 376

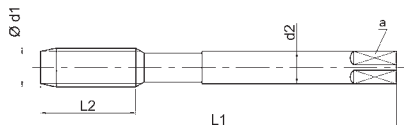

Profond. di filettatura - Thread depth - Profond. de filetage

Materiale - Material - Matériau

Tolleranza - Tolerance - Tolérance

Trattamento superficiale - Surface treatment - Revêtement

Numero gruppi materiali

Material's groups number

Nombre de groupes du matériau

TOP



TOP



3xD

3xD

PM3

PM3

2BX

2BX

XP

XP

1.1 1.2 1.3 1.4 1.5

1.1 1.2 1.3 1.4 1.5

2.1 2.2 2.3

2.1 2.2 2.3

3.3 3.4 4.2 4.3

3.3 3.4 4.2 4.3

5.2

5.2

DIN 371	Ød1 UNC	P TPI	Ø mm	L ₁	L ₂	d ₂ h ₉	a h ₁₂	Z	
◀	4	40	2,845	56	10	3,5	2,7	3	2,35
◀	5	40	3,175	56	10	3,5	2,7	3	2,65
◀	6	32	3,505	56	11	4	3	3	2,85
◀	8	32	4,166	63	13	4,5	3,4	3	3,5
◀	10	24	4,826	70	13	6	4,9	3	3,9
◀	1/4	20	6,350	80	16	7	5,5	3	5,1
◀	5/16	18	7,938	90	18	8	6,2	3	6,6
◀	3/8	16	9,525	100	20	10	8	3	8

CODICE - CODE	
K24UNC...XP	K24UNC...FORY-XP
○	-
○	-
○	-
○	-
○	-
○	○
○	○
○	○
○	○
○	○

DIN 376	Ød1 UNC	P TPI	Ø mm	L ₁	L ₂	d ₂ h ₉	a h ₁₂	Z	
	7/16	14	11,113	100	20	8	6,2	3	9,4
	1/2	13	12,700	110	25	9	7	4	10,8
	9/16	12	14,288	110	28	11	9	4	12,2
	5/8	11	15,875	110	28	12	9	4	13,5
	3/4	10	19,050	125	32	14	11	4	16,5
	7/8	9	22,225	140	32	18	14,5	4	19,5
	1"	8	25,400	160	36	18	14,5	4	22,25

CODICE - CODE	
K25UNC...XP	K25UNC...FORY-XP
○	○
○	○
○	○
○	○
○	○
○	○
○	○

Confezione / Box / Colis:
6 - 7/16: 10 pezzi / pcs
1/2 - 9/16: 5 pezzi / pcs
>9/16: singoli / single pcs

€ Pag. listino - Price list - Liste des prix

75

75

• Standard

○ Disponibilità da richiedere, prezzo a listino
On enquiry, standard price-list / Stock à vérifier

★ Solo a richiesta
Only on request / Sur demande

MASCHI A MACCHINA

MACHINE TAPS - TARAUDS MACHINE

DIN 371

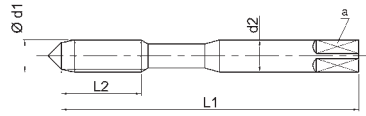

DIN 376

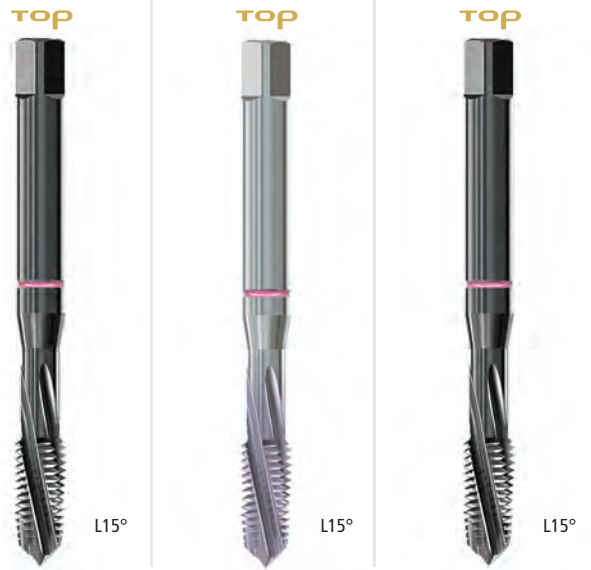
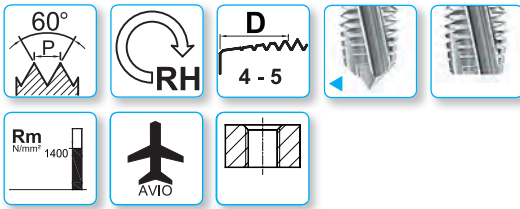
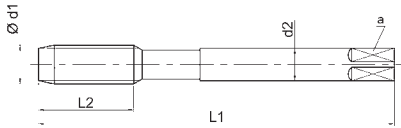

Profond. di filettatura - Thread depth - Profond. de filetage
 Materiale - Material - Matériau
 Tolleranza - Tolerance - Tolérance
 Trattamento superficiale - Surface treatment - Revêtement

3xD	3xD	3xD
PM3	PM3	PM3
2BX	2BX	3BX
V	TiCN	V
6.1	1.6 2.4	6.1
	3.3 3.4	
	4.4 5.3 5.4 6.2 6.3	
	7.2 9.2	

Numero gruppi materiali
 Material's groups number
 Nombre de groupes du matériau

DIN 371	$\varnothing d1$ UNC	P TPI	\varnothing mm	L ₁	L ₂	d ₂ h ₉	a h ₁₂	Z	
6	32	3,505	56	11	4	3	3	*2,85	
8	32	4,166	63	13	4,5	3,4	3	*3,5	
10	24	4,826	70	13	6	4,9	3	*3,9	
1/4	20	6,350	80	16	7	5,5	3	*5,1	
5/16	18	7,938	90	18	8	6,2	3	*6,6	
3/8	16	9,525	100	20	10	8	3	*8	

CODICE - CODE		
K52UNC...V	K52UNC...CT	K52UNC...V-3BX
<input type="radio"/>	<input type="radio"/>	<input type="radio"/>
<input type="radio"/>	<input type="radio"/>	<input type="radio"/>
<input type="radio"/>	<input type="radio"/>	<input type="radio"/>
<input type="radio"/>	<input type="radio"/>	<input type="radio"/>
<input type="radio"/>	<input type="radio"/>	<input type="radio"/>
<input type="radio"/>	<input type="radio"/>	<input type="radio"/>
<input type="radio"/>	<input type="radio"/>	<input type="radio"/>
<input type="radio"/>	<input type="radio"/>	<input type="radio"/>
<input type="radio"/>	<input type="radio"/>	<input type="radio"/>
<input type="radio"/>	<input type="radio"/>	<input type="radio"/>

DIN 376	$\varnothing d1$ UNC	P TPI	\varnothing mm	L ₁	L ₂	d ₂ h ₉	a h ₁₂	Z	
new 7/16	13	11,113	100	20	8	6,2	3	*9,4	
1/2	14	12,700	110	25	9	7	3	*10,8	
5/8	11	15,875	110	28	12	9	3	*13,5	
3/4	10	19,050	125	32	14	11	4	*16,5	

CODICE - CODE		
K53UNC...V	K53UNC...CT	K53UNC...V-3BX
<input type="radio"/>	<input type="radio"/>	<input type="radio"/>
<input type="radio"/>	<input type="radio"/>	<input type="radio"/>
<input type="radio"/>	<input type="radio"/>	<input type="radio"/>
<input type="radio"/>	<input type="radio"/>	<input type="radio"/>
<input type="radio"/>	<input type="radio"/>	<input type="radio"/>
<input type="radio"/>	<input type="radio"/>	<input type="radio"/>
<input type="radio"/>	<input type="radio"/>	<input type="radio"/>
<input type="radio"/>	<input type="radio"/>	<input type="radio"/>
<input type="radio"/>	<input type="radio"/>	<input type="radio"/>
<input type="radio"/>	<input type="radio"/>	<input type="radio"/>

* Per UNJC vedi tabella di foratura pag. 254
 * Drills' diameters for UNJC: table page 254
 * Pour UNJC voir le tableau de perçage page 254

MASCHI A MACCHINA

MACHINE TAPS - TARAUDS MACHINE

DIN 371

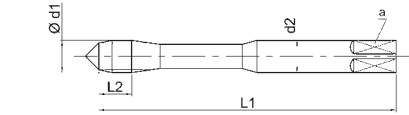

DIN 371

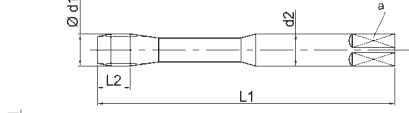

DIN 376

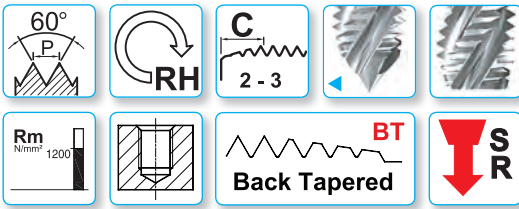
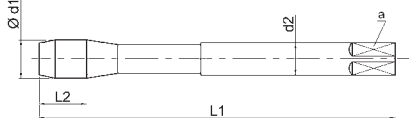

Profond. di filettatura - Thread depth - Profond. de filetage

Materiale - Material - Matériau

Tolleranza - Tolerance - Tolérance

Trattamento superficiale - Surface treatment - Revêtement

Numero gruppi materiali
 Material's groups number
 Nombre de groupes du matériau

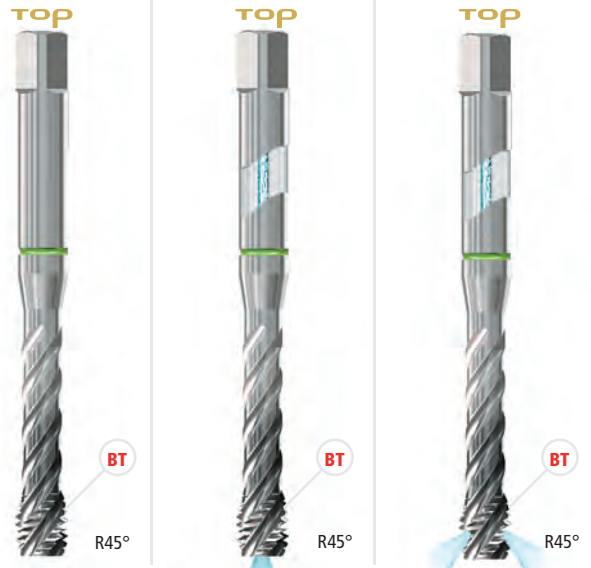

3xD	3,5xD	3,5xD
PM3	PM3	PM3
2BX	2BX	2BX
XP	XP	XP
1.1 1.2 1.3 1.4 1.5	1.1 1.2 1.3 1.4 1.5	1.1 1.2 1.3 1.4 1.5
2.1 2.2 2.3	2.1 2.2 2.3	2.1 2.2 2.3
3.3 3.4 4.2 4.3	3.3 3.4 4.2 4.3	3.3 3.4 4.2 4.3
5.2	5.2	5.2

DIN 371	Ød1 UNC	P TPI	Ø mm	L ₁	L ₂	d ₂ h ₉	a h ₁₂	Z	
4	40	2,845	56	5	3,5	2,7	3	2,35	
5	40	3,175	56	5	3,5	2,7	3	2,65	
6	32	3,505	56	7	4	3	3	2,85	
8	32	4,166	63	7	4,5	3,4	3	3,5	
10	24	4,826	70	8	6	4,9	3	3,9	
1/4	20	6,350	80	10	7	5,5	3	5,1	
5/16	18	7,938	90	13	8	6,2	3	6,6	
3/8	16	9,525	100	15	10	8	3	8	

CODICE - CODE		
K82UNC...XP	K82UNC...FOR-XP	K82UNC...FORY-XP
○	-	-
○	-	-
○	-	-
○	-	-
○	-	-
○	○	○
○	○	○
○	○	○
○	○	○
○	○	○
○	○	○

DIN 376	Ød1 UNC	P TPI	Ø mm	L ₁	L ₂	d ₂ h ₉	a h ₁₂	Z	
7/16	14	11,113	100	15	8	6,2	3	9,4	
1/2	13	12,700	110	18	9	7	4	10,8	
9/16	12	14,288	110	20	11	9	4	12,2	
5/8	11	15,875	110	20	12	9	4	13,5	
3/4	10	19,050	125	25	14	11	4	16,5	
7/8	9	22,225	140	25	18	14,5	4	19,5	
1"	8	25,400	160	30	18	14,5	4	22,25	

CODICE - CODE		
K83UNC...XP	K83UNC...FOR-XP	K83UNC...FORY-XP
○	○	○
○	○	○
○	○	○
○	○	○
○	○	○
○	○	○
○	○	○

RACCOMANDATO per filettatura rigida
 We recommend Syncro rigid threading
 Recommandé pour le taraudage rigide





UNF



UNF

N **USO GENERALE**
 General purpose - Usage Général

MASCHI A MACCHINA
 MACHINE TAPS - TARAUDS MACHINE

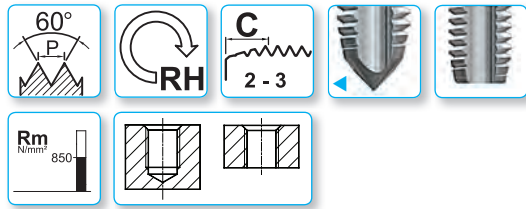
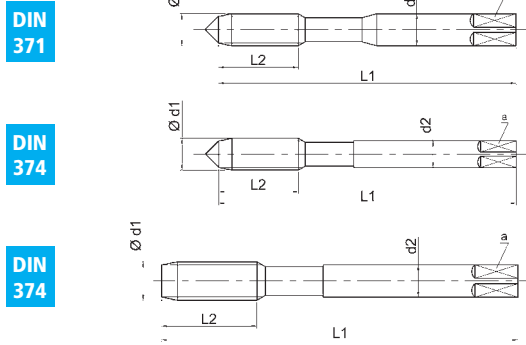

Profond. di filettatura - Thread depth - Profond. de filetage
 Materiale - Material - Matériau
 Tolleranza - Tolerance - Tolérance
 Trattamento superficiale - Surface treatment - Revêtement

Numero gruppi materiali
 Material's groups number
 Nombre de groupes du matériau

1,5xD	1,5xD
HSSE	HSSE
2B	2B
BR	TiN
1.1 1.2 1.3 1.4 3.4	1.1 1.2 1.3 1.4 3.4
4.2 4.3 5.2 5.3	4.2 4.3 5.2 5.3
8.2	8.2

DIN 371	Ød1 UNF	P TPI	Ø mm	L ₁	L ₂	d ₂ h9	a h12	Z	Icon
◀	6	40	3,505	56	11	4	3	3	2,95
◀	8	36	4,166	63	13	4,5	3,4	3	3,5
◀	10	32	4,826	70	13	6	4,9	3	4,1
◀	12	28	5,486	80	16	6	4,9	3	4,6
◀	1/4	28	6,350	80	16	7	5,5	3	5,5

CODICE - CODE	
E20UNF...	E20UNF...T
•	○
•	○
•	○
○	○
•	○

DIN 374	Ød1 UNF	P TPI	Ø mm	L ₁	L ₂	d ₂ h9	a h12	Z	Icon
◀	1/4	28	6,350	80	16	4,5	3,4	3	5,5
◀	5/16	24	7,938	90	18	6	4,9	3	6,9
◀	3/8	24	9,525	90	15	7	5,5	3	8,5
	7/16	20	11,113	100	20	8	6,2	3	9,9
	1/2	20	12,700	100	20	9	7	3	11,5
	9/16	18	14,288	100	22	11	9	4	12,9
	5/8	18	15,875	100	22	12	9	4	14,5
	3/4	16	19,050	110	25	14	11	4	17,5
	7/8	14	22,225	125	25	18	14,5	4	20,4
	1"	12	25,400	140	28	18	14,5	4	23,25
	1" 1/8	12	28,575	150	28	22	18	4	26,5
	1" 1/4	12	31,750	150	28	22	18	5	29,5
	1" 3/8	12	34,925	170	30	28	22	5	32,75
	1" 1/2	12	38,100	170	30	28	22	6	36

CODICE - CODE	
E21UNF...	E21UNF...T
○	○
•	○
•	○
•	○
•	○
○	○
•	○
•	○
○	○
•	○
○	○
•	○

Confezione / Box / Colis: 6 - 7/16: 10 pezzi / pcs
 1/2 - 9/16: 5 pezzi / pcs
 >9/16: singoli / single pcs

€ Pag. listino - Price list - Liste des prix

82 82

• Standard ○ Disponibilità da richiedere, prezzo a listino
 On enquiry, standard price-list / Stock à vérifier

★ Solo a richiesta
 Only on request / Sur demande

MASCHI A MACCHINA

MACHINE TAPS - TARAUDS MACHINE

DIN 371

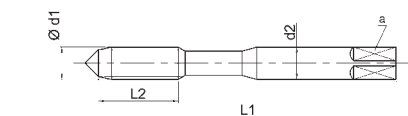

DIN 374

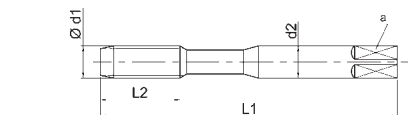

DIN 374

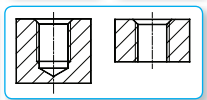
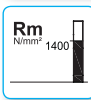
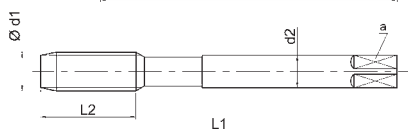

Profond. di filettatura - Thread depth - Profond. de filetage

Materiale - Material - Matériau

Tolleranza - Tolerance - Tolérance

Trattamento superficiale - Surface treatment - Revêtement

Al Si>10%,
Ottone / Brass / Laiton
Bronzo / Bronze / Bronze
truciolo corto / short chip /
coupeaux courts

Numero gruppi materiali
Material's groups number
Nombre de groupes du matériau

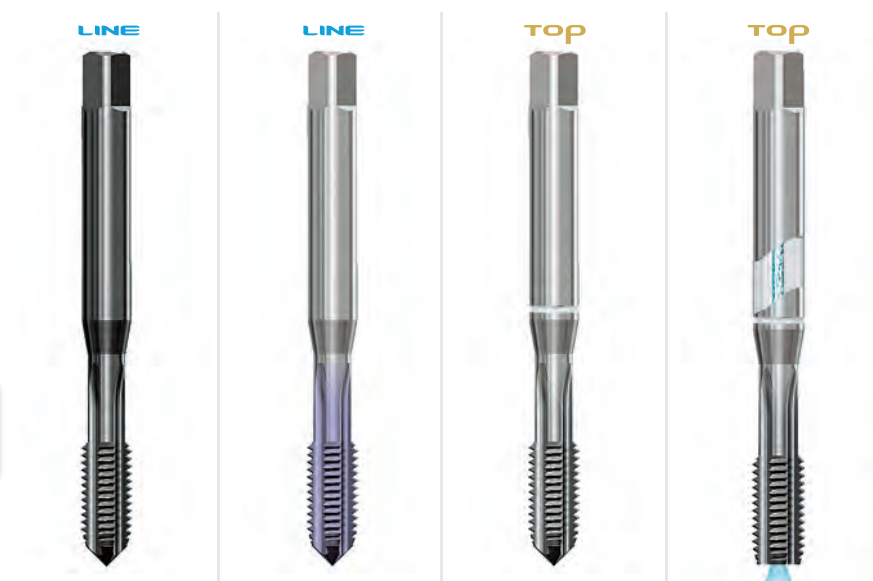

LINE	LINE	TOP	TOP
3xD	3xD	3xD	3,5xD
HSSE	HSSE	PM3	PM3
2BX	2BX	2BX	2BX
NQ	TiCN	TiAlN	TiAlN
3.1 3.2 3.3 3.4 3.5	3.1 3.2 3.3 3.4 3.5	3.1 3.2 3.3 3.4 3.5	3.1 3.2 3.3 3.4 3.5
4.3 4.4 4.5 4.6 5.3	4.3 4.4 4.5 4.6 5.3	4.4 5.3 5.4	4.4 5.3 5.4
8.2 10.1	8.2 10.1	10.1	10.1

DIN 371	$\varnothing d1$ UNF	P TPI	\varnothing mm	L_1	L_2	d_2 h9	a h12	Z	
6	40	3,505	56	11	4	3	3	2,95	
8	36	4,166	63	13	4,5	3,4	3	3,5	
10	32	4,826	70	13	6	4,9	3	4,1	
12	28	5,486	80	16	6	4,9	3	4,6	
1/4	28	6,350	80	16	7	5,5	3	5,5	
1/4	28	6,350	80	16	7	5,5	4	5,5	
1/4	28	6,350	80	16	7	5,5	4	5,5	

DIN 374	$\varnothing d1$ UNF	P TPI	\varnothing mm	L_1	L_2	d_2 h9	a h12	Z	
1/4	28	6,350	80	16	4,5	3,4	3	5,5	
5/16	24	7,938	90	18	6	4,9	4	6,9	
3/8	24	9,525	90	15	7	5,5	4	8,5	
7/16	20	11,113	100	20	8	6,2	4	9,9	
1/2	20	12,700	100	20	9	7	4	11,5	
9/16	18	14,288	100	22	11	9	4	12,9	
5/8	18	15,875	100	22	12	9	4	14,5	
3/4	16	19,050	110	25	14	11	4	17,5	
7/8	14	22,225	125	25	18	14,5	4	20,4	
1"	12	25,400	140	28	18	14,5	4	23,25	
3/4	16	19,050	110	25	14	11	5	17,5	
7/8	14	22,225	125	25	18	14,5	6	20,4	
1"	12	25,400	140	28	18	14,5	6	23,25	

CODICE - CODE			
E26UNF...NQ	E26UNF...CT	K26UNF...TX	
*	o	-	-
*	o	-	-
*	•	-	-
*	o	-	-
*	•	-	-
-	-	o	-
-	-	-	K26UNF...FOR-TX
-	-	-	o

CODICE - CODE			
E27UNF...NQ	E27UNF...CT	K27UNF...TX	K27UNF...FOR-TX
*	*	o (SP, Z=4)	o (SP, Z=4)
*	•	o (SP)	o (SP)
*	•	o (SP)	o (SP)
*	•	o	o
*	•	o	o
*	o	o	o
*	o	o	o
*	o	-	-
*	o	-	-
*	o	-	-
-	-	o	o
-	-	o	o
-	-	o	o

SP= Senza punta anteriore
Without centre male, Sans pointe avant



Confezione / Box / Colis:
6 - 7/16: 10 pezzi / pcs
1/2 - 9/16: 5 pezzi / pcs
>9/16: singoli / single pcs

€ Pag. listino - Price list - Liste des prix

• Standard

82

o Disponibilità da richiedere, prezzo a listino
On enquiry, standard price-list / Stock à vérifier

82

* Solo a richiesta
Only on request / Sur demande

82

83

N **USO GENERALE**
 General purpose - Usage Général

MASCHI A MACCHINA
 MACHINE TAPS - TARAUDS MACHINE

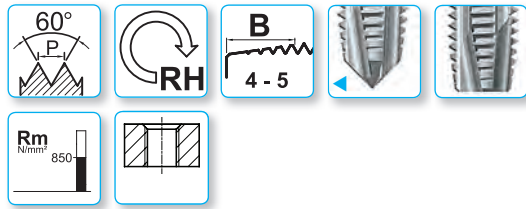
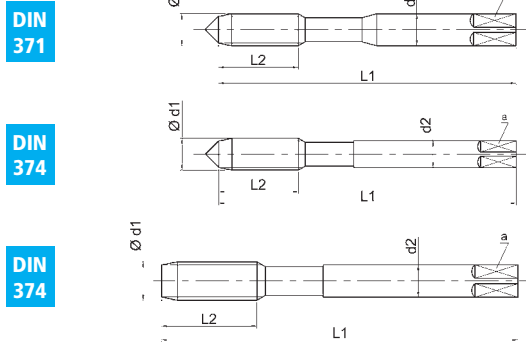

Profond. di filettatura - Thread depth - Profond. de filetage
 Materiale - Material - Matériau
 Tolleranza - Tolerance - Tolérance
 Trattamento superficiale - Surface treatment - Revêtement

3xD	3xD	3xD	3xD
HSSE	HSSE	HSSE	HSSE
2B	2B	2B	2B
BR	V	TiN	XP
1.1 1.2 1.3 1.4	1.1 1.2 1.3 1.4	1.1 1.2 1.3 1.4	1.1 1.2 1.3 1.4
4.1 4.2	4.1 4.2	3.3 3.4	2.1 2.2 3.3 3.4
5.1 5.2	5.1 5.2	4.1 4.2 4.3	4.2 4.3
	6.1 7.1	5.1 5.2	5.2

Numero gruppi materiali
 Material's groups number
 Nombre de groupes du matériau

DIN 371	Ød1 UNF	P TPI	Ø mm	L1	L2	d2 h9	a h12	Z	Icon
◀	6	40	3,505	56	11	4	3	3	2,95
◀	8	36	4,166	63	13	4,5	3,4	3	3,5
◀	10	32	4,826	70	13	6	4,9	3	4,1
◀	12	28	5,486	80	16	6	4,9	3	4,6
◀	1/4	28	6,350	80	16	7	5,5	3	5,5

CODICE - CODE			
E24UNF...	E24UNF...V	E24UNF...T	E24UNF...XP
•	○	○	○
•	○	○	○
•	○	○	○
○	○	○	○
•	○	○	○

DIN 374	Ød1 UNF	P TPI	Ø mm	L1	L2	d2 h9	a h12	Z	Icon
◀	1/4	28	6,350	80	16	4,5	3,4	3	5,5
◀	5/16	24	7,938	90	18	6	4,9	3	6,9
◀	3/8	24	9,525	90	15	7	5,5	3	8,5
	7/16	20	11,113	100	20	8	6,2	3	9,9
	1/2	20	12,700	100	20	9	7	3	11,5
	9/16	18	14,288	100	22	11	9	4	12,9
	5/8	18	15,875	100	22	12	9	4	14,5
	3/4	16	19,050	110	25	14	11	4	17,5
	7/8	14	22,225	125	25	18	14,5	4	20,4
	1"	12	25,400	140	28	18	14,5	4	23,25
	1"1/8	12	28,575	150	28	22	18	4	26,5
	1"1/4	12	31,750	150	28	22	18	5	29,5
	1"3/8	12	34,925	170	30	28	22	5	32,75
	1"1/2	12	38,100	170	30	28	22	6	36

CODICE - CODE			
E25UNF...	E25UNF...V	E25UNF...T	E25UNF...XP
○	○	○	○
•	○	○	○
•	○	○	○
•	○	○	○
•	○	○	○
○	○	○	○
•	○	○	○
•	○	○	○
○	○	○	○
•	○	○	○
•	○	○	○

Confezione / Box / Colis: 6 - 7/16: 10 pezzi / pcs
 1/2 - 9/16: 5 pezzi / pcs
 >9/16: singoli / single pcs

€ Pag. listino - Price list - Liste des prix

83	83	83	83
• Standard	○ Disponibilità da richiedere, prezzo a listino On enquiry, standard price-list / Stock à vérifier	• Solo a richiesta Only on request / Sur demande	

MASCHI A MACCHINA

MACHINE TAPS - TARAUDS MACHINE

DIN 371

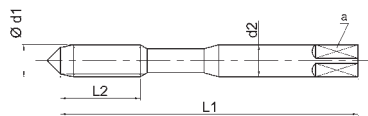

DIN 374

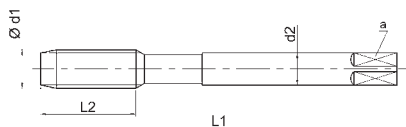

Profond. di filettatura - Thread depth - Profond. de filetage

Materiale - Material - Matériau

Tolleranza - Tolerance - Tolérance

Trattamento superficiale - Surface treatment - Revêtement

Numero gruppi materiali

Material's groups number

Nombre de groupes du matériau







TOP













TOP



3xD	3xD
PM3	PM3
2BX	2BX
XP	XP
1.1 1.2 1.3 1.4 1.5	1.1 1.2 1.3 1.4 1.5
2.1 2.2 2.3	2.1 2.2 2.3
3.3 3.4 4.2 4.3	3.3 3.4 4.2 4.3
5.2	5.2

DIN 371	Ød1 UNF	P TPI	Ø mm	L ₁	L ₂	d ₂ h9	a h12	Z	
4	48	2,845	56	10	3,5	2,7	3	2,4	
6	40	3,505	56	11	4	3	3	2,95	
8	36	4,166	63	13	4,5	3,4	3	3,5	
10	32	4,826	70	13	6	4,9	3	4,1	
1/4	28	6,350	80	16	7	5,5	3	5,5	

CODICE - CODE	
K24UNF...XP	K24UNF...FORY-XP
○	-
○	-
○	-
○	-
○	○

DIN 374	Ød1 UNF	P TPI	Ø mm	L ₁	L ₂	d ₂ h9	a h12	Z	
5/16	24	7,938	90	18	6	4,9	3	6,9	
3/8	24	9,525	90	15	7	5,5	3	8,5	
7/16	20	11,113	100	20	8	6,2	3	9,9	
1/2	20	12,700	100	20	9	7	4	11,5	
9/16	18	14,288	100	22	11	9	4	12,9	
5/8	18	15,875	100	22	12	9	4	14,5	
3/4	16	19,050	110	25	14	11	4	17,5	
7/8	14	22,225	125	25	18	14,5	4	20,4	
1"	12	25,400	140	28	18	14,5	4	23,25	

CODICE - CODE	
K25UNF...XP	K25UNF...FORY-XP
○	○
○	○
○	○
○	○
○	○
○	○
○	○
○	○

Confezione / Box / Colis:
6 - 7/16: 10 pezzi / pcs
1/2 - 9/16: 5 pezzi / pcs
>9/16: singoli / single pcs

€ Pag. listino - Price list - Liste des prix

84

84

● Standard

○ Disponibilità da richiedere, prezzo a listino
On enquiry, standard price-list / Stock à vérifier

★ Solo a richiesta
Only on request / Sur demande

INOX

ACCIAIO INOSSIDABILE
 Stainless steel - Acier inoxydable

MASCHI A MACCHINA

MACHINE TAPS - TARAUDS MACHINE

DIN 371

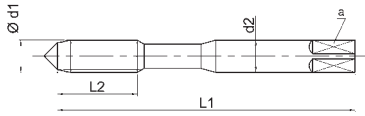

DIN 374

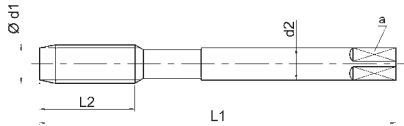

TOP



Profond. di filettatura - Thread depth - Profond. de filetage

3xD

Materiale - Material - Matériau

HSSV3

Tolleranza - Tolerance - Tolérance

2BX

Trattamento superficiale - Surface treatment - Revêtement

TXC

Numero gruppi materiali

Material's groups number

Nombre de groupes du matériau

1.3 1.4 1.5

2.1 2.2 2.3 2.4

DIN 371	Ød1 UNF	P TPI	Ø mm	L ₁	L ₂	d ₂ h9	a h12	Z	
◀	6	40	3,505	56	11	4	3	3	2,95
◀	8	36	4,166	63	13	4,5	3,4	3	3,5
◀	10	32	4,826	70	13	6	4,9	3	4,1
◀	1/4	28	6,350	80	16	7	5,5	3	5,5

CODICE - CODE	
V24UNF...TXC	
○	
○	
○	
○	

DIN 374	Ød1 UNF	P TPI	Ø mm	L ₁	L ₂	d ₂ h9	a h12	Z	
	5/16	24	7,938	90	18	6	4,9	3	6,9
	3/8	24	9,525	90	15	7	5,5	3	8,5
	7/16	20	11,113	100	20	8	6,2	3	9,9
	1/2	20	12,700	100	20	9	7	4	11,5
	9/16	18	14,288	100	22	11	9	4	12,9
	5/8	18	15,875	100	22	12	9	4	14,5
	3/4	16	19,050	110	25	14	11	4	17,5
	7/8	14	22,225	125	25	18	14,5	4	20,4
	1"	12	25,400	140	28	18	14,5	4	23,25

CODICE - CODE	
V25UNF...TXC	
○	
○	
○	
○	
○	
○	
○	
○	

Confezione / Box / Colis:
 6 - 7/16: 10 pezzi / pcs
 1/2 - 9/16: 5 pezzi / pcs
 >9/16: singoli / single pcs

€ Pag. listino - Price list - Liste des prix

84

● Standard

○ Disponibilità da richiedere, prezzo a listino
 On enquiry, standard price-list / Stock à vérifier

★ Solo a richiesta
 Only on request / Sur demande

UNF

Filettatura americana UNF passo fine ASME B1.1

UNF fine thread ASME B1.1

Unified-Feingewinde UNF ASME B1.1 - Maschinengewindebohrer

Filetage américain à pas fin UNF - Tarauds machine

Rosca fina UNF ASME B1.1 - Machos de roscar a máquina



Ti

TITANIO

Titanium - Titane

MASCHI A MACCHINA

MACHINE TAPS - TARAUDS MACHINE

DIN 371

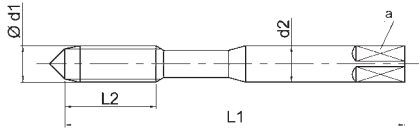

DIN 374

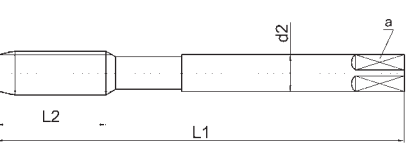

UNF

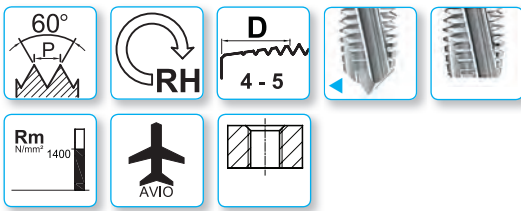

Profond. di filettatura - Thread depth - Profond. de filetage

Materiale - Material - Matériau

Tolleranza - Tolerance - Tolérance

Trattamento superficiale - Surface treatment - Revêtement

Numero gruppi materiali

Material's groups number

Nombre de groupes du matériau

TOP



115°

TOP



115°

TOP



115°

3xD	3xD	3xD
PM3	PM3	PM3
2BX	2BX	3BX
V	TiCN	V
6.1	1.6 2.4	6.1
	3.3 3.4	
	4.4 5.3 5.4 6.2 6.3	
	7.2 9.2	

DIN 371	Ød1 UNF	P TPI	Ø mm	L1	L2	d2 h9	a h12	Z	
6	40	3,505	56	11	4	3	3	*2,95	
8	36	4,166	63	13	4,5	3,4	3	*3,5	
10	32	4,826	70	13	6	4,9	3	*4,1	
1/4	28	6,350	80	16	7	5,5	3	*5,5	
5/16	24	7,938	90	18	8	6,2	3	*6,9	
3/8	24	9,525	100	20	10	8	3	*8,5	

CODICE - CODE		
K52UNF...V	K52UNF...CT	K52UNF...V-3BX
<input type="radio"/>	<input type="radio"/>	<input type="radio"/>
<input type="radio"/>	<input type="radio"/>	<input type="radio"/>
<input type="radio"/>	<input type="radio"/>	<input type="radio"/>
<input type="radio"/>	<input type="radio"/>	<input type="radio"/>
<input type="radio"/>	<input type="radio"/>	<input type="radio"/>
<input type="radio"/>	<input type="radio"/>	<input type="radio"/>
<input type="radio"/>	<input type="radio"/>	<input type="radio"/>

DIN 374	Ød1 UNF	P TPI	Ø mm	L1	L2	d2 h9	a h12	Z	
7/16	20	11,113	100	20	8	6,2	3	*9,9	
1/2	20	12,700	100	20	9	7	3	*11,5	
5/8	18	15,875	100	22	12	9	3	*14,5	
3/4	16	19,050	110	25	14	11	4	*17,5	

CODICE - CODE		
K53UNF...V	K53UNF...CT	K53UNF...V-3BX
<input type="radio"/>	<input type="radio"/>	<input type="radio"/>
<input type="radio"/>	<input type="radio"/>	<input type="radio"/>
<input type="radio"/>	<input type="radio"/>	<input type="radio"/>
<input type="radio"/>	<input type="radio"/>	<input type="radio"/>

* Per UNF vedi tabella di foratura pag. 255
 * Drills' diameters for UNF: table page 255
 * Pour UNF voir le tableau de perçage page 255

Confezione / Box / Colis:
 6 - 7/16: 10 pezzi / pcs
 1/2 - 9/16: 5 pezzi / pcs
 >9/16: singoli / single pcs

€ Pag. listino - Price list - Liste des prix

84

84

85

• Standard

○ Disponibilità da richiedere, prezzo a listino
 On enquiry, standard price-list / Stock à vérifier

★ Solo a richiesta
 Only on request / Sur demande

N **USO GENERALE**
 General purpose - Usage Général

MASCHI A MACCHINA
 MACHINE TAPS - TARAUDS MACHINE

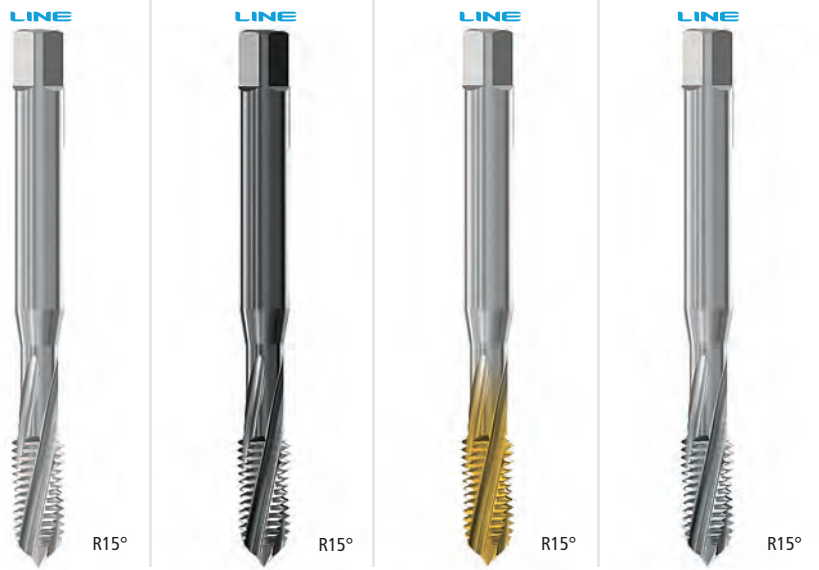
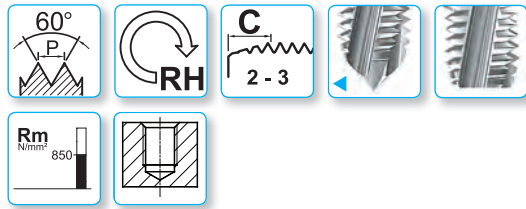
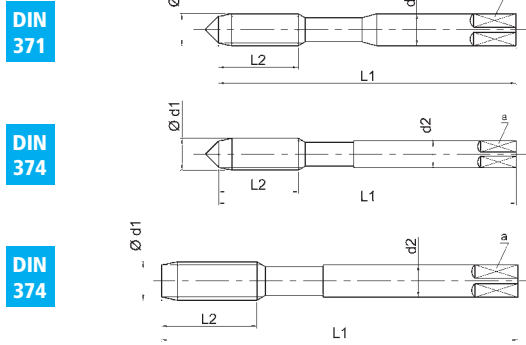

Profond. di filettatura - Thread depth - Profond. de filetage	1,5xD	1,5xD	1,5xD	1,5xD
Materiale - Material - Matériau	HSSE	HSSE	HSSE	HSSE
Tolleranza - Tolerance - Tolérance	2B	2B	2B	2B
Trattamento superficiale - Surface treatment - Revêtement	BR	V	TiN	XP
Numero gruppi materiali Material's groups number Nombre de groupes du matériau	1.1 1.2 1.3 1.4 4.1 4.2 5.1 5.2	1.1 1.2 1.3 1.4 4.1 4.2 5.1 5.2 6.1 7.1	1.1 1.2 1.3 1.4 3.3 3.4 4.1 4.2 4.3 5.1 5.2	1.1 1.2 1.3 1.4 3.3 3.4 4.2 4.3 5.2

DIN 371	Ød1 UNF	P TPI	Ø mm	L1	L2	d2 h9	a h12	Z	Icon
◀	6	40	3,505	56	11	4	3	3	2,95
◀	8	36	4,166	63	13	4,5	3,4	3	3,5
◀	10	32	4,826	70	13	6	4,9	3	4,1
◀	12	28	5,486	80	16	6	4,9	3	4,6
◀	1/4	28	6,350	80	16	7	5,5	3	5,5

CODICE - CODE			
E40UNF...	E40UNF...V	E40UNF...T	E40UNF...XP
•	○	○	○
•	○	○	○
•	○	○	○
○	○	○	○
•	○	○	○

DIN 374	Ød1 UNF	P TPI	Ø mm	L1	L2	d2 h9	a h12	Z	Icon
◀	1/4	28	6,350	80	16	4,5	3,4	3	5,5
◀	5/16	24	7,938	90	18	6	4,9	3	6,9
◀	3/8	24	9,525	90	15	7	5,5	3	8,5
	7/16	20	11,113	100	20	8	6,2	3	9,9
	1/2	20	12,700	100	20	9	7	3	11,5
	9/16	18	14,288	100	22	11	9	3	12,9
	5/8	18	15,875	100	22	12	9	3	14,5
	3/4	16	19,050	110	25	14	11	4	17,5
	7/8	14	22,225	125	25	18	14,5	4	20,4
	1"	12	25,400	140	28	18	14,5	4	23,25
	1"1/8	12	28,575	150	28	22	18	4	26,5
	1"1/4	12	31,750	150	28	22	18	5	29,5
	1"3/8	12	34,925	170	30	28	22	5	32,75
	1"1/2	12	38,100	170	30	28	22	6	36

CODICE - CODE			
E41UNF...	E41UNF...V	E41UNF...T	E41UNF...XP
○	○	○	○
•	○	○	○
•	○	○	○
•	○	○	○
•	○	○	○
○	○	○	○
•	○	○	○
•	○	○	○
○	○	○	○
•	○	○	○
•	○	○	○

Confezione / Box / Colis: 6 - 7/16: 10 pezzi / pcs 1/2 - 9/16: 5 pezzi / pcs >9/16: singoli / single pcs	€ Pag. listino - Price list - Liste des prix	85	85	85	85
	• Standard	○ Disponibilità da richiedere, prezzo a listino On enquiry, standard price-list / Stock à vérifier		★ Solo a richiesta Only on request / Sur demande	

UNF

Filettatura americana UNF passo fine ASME B1.1

UNF fine thread ASME B1.1

Unified-Feingewinde UNF ASME B1.1 – Maschinengewindebohrer

Filetage américain à pas fin UNF – Tarauds machine

Rosca fina UNF ASME B1.1 – Machos de rosca a máquina



Ti

TITANIO

Titanium - Titane

MASCHI A MACCHINA

MACHINE TAPS - TARAUDS MACHINE

DIN 371

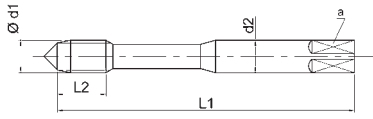

DIN 371

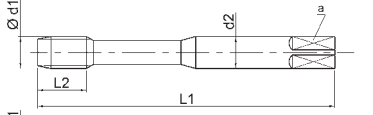

DIN 374

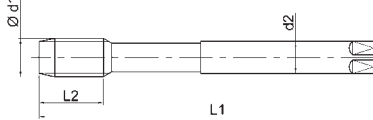

top



R15°

top



R15°

top



R15°

Profond. di filettatura - Thread depth - Profond. de filetage

Materiale - Material - Matériau

Tolleranza - Tolerance - Tolérance

Trattamento superficiale - Surface treatment - Revêtement

Numero gruppi materiali

Material's groups number

Nombre de groupes du matériau

1,5xD

1,5xD

1,5xD

PM3

PM3

PM3

2BX

2BX

3BX

V

TiCN

V

6.1	1.6 2.4	6.1
	3.3 3.4	
	4.4 5.3 5.4 6.2 6.3	
	7.2 9.2	

DIN 371	Ød1 UNF	P TPI	Ø mm	L ₁	L ₂	d ₂ h9	a h12	Z	
6	40	3,505	56	7	4	3	3	*2,95	
8	36	4,166	63	7	4,5	3,4	3	*3,5	
10	32	4,826	70	8	6	4,9	3	*4,1	
1/4	28	6,350	80	10	7	5,5	3	*5,5	
5/16	24	7,938	90	13	8	6,2	3	*6,9	
3/8	24	9,525	100	15	10	8	3	*8,5	

K42UNF...V	CODICE - CODE	
	K42UNF...CT	K42UNF...V-3BX
<input type="radio"/>	<input type="radio"/>	<input type="radio"/>
<input type="radio"/>	<input type="radio"/>	<input type="radio"/>
<input type="radio"/>	<input type="radio"/>	<input type="radio"/>
<input type="radio"/>	<input type="radio"/>	<input type="radio"/>
<input type="radio"/>	<input type="radio"/>	<input type="radio"/>
<input type="radio"/>	<input type="radio"/>	<input type="radio"/>
<input type="radio"/>	<input type="radio"/>	<input type="radio"/>
<input type="radio"/>	<input type="radio"/>	<input type="radio"/>
<input type="radio"/>	<input type="radio"/>	<input type="radio"/>
<input type="radio"/>	<input type="radio"/>	<input type="radio"/>

DIN 374	Ød1 UNF	P TPI	Ø mm	L ₁	L ₂	d ₂ h9	a h12	Z	
7/16	20	11,113	100	15	8	6,2	3	*9,9	
1/2	20	12,700	100	13	9	7	4	*11,5	
5/8	18	15,875	100	15	12	9	4	*14,5	
3/4	16	19,050	110	17	14	11	4	*17,5	

K43UNF...V	CODICE - CODE	
	K43UNF...CT	K43UNF...V-3BX
<input type="radio"/>	<input type="radio"/>	<input type="radio"/>
<input type="radio"/>	<input type="radio"/>	<input type="radio"/>
<input type="radio"/>	<input type="radio"/>	<input type="radio"/>
<input type="radio"/>	<input type="radio"/>	<input type="radio"/>
<input type="radio"/>	<input type="radio"/>	<input type="radio"/>
<input type="radio"/>	<input type="radio"/>	<input type="radio"/>
<input type="radio"/>	<input type="radio"/>	<input type="radio"/>
<input type="radio"/>	<input type="radio"/>	<input type="radio"/>
<input type="radio"/>	<input type="radio"/>	<input type="radio"/>
<input type="radio"/>	<input type="radio"/>	<input type="radio"/>

* Per UNJF vedi tabella di foratura pag. 255
 * Drills' diameters for UNJF: table page 255
 * Pour UNJF voir le tableau de perçage page 255

Confezione / Box / Colis:
 6 - 7/16: 10 pezzi / pcs
 1/2 - 9/16: 5 pezzi / pcs
 >9/16: singoli / single pcs

€ Pag. listino - Price list - Liste des prix

86

86

86

• Standard

○ Disponibilità da richiedere, prezzo a listino
 On enquiry, standard price-list / Stock à vérifier

★ Solo a richiesta
 Only on request / Sur demande

N **USO GENERALE**
 General purpose - Usage Général

MASCHI A MACCHINA
 MACHINE TAPS - TARAUDS MACHINE

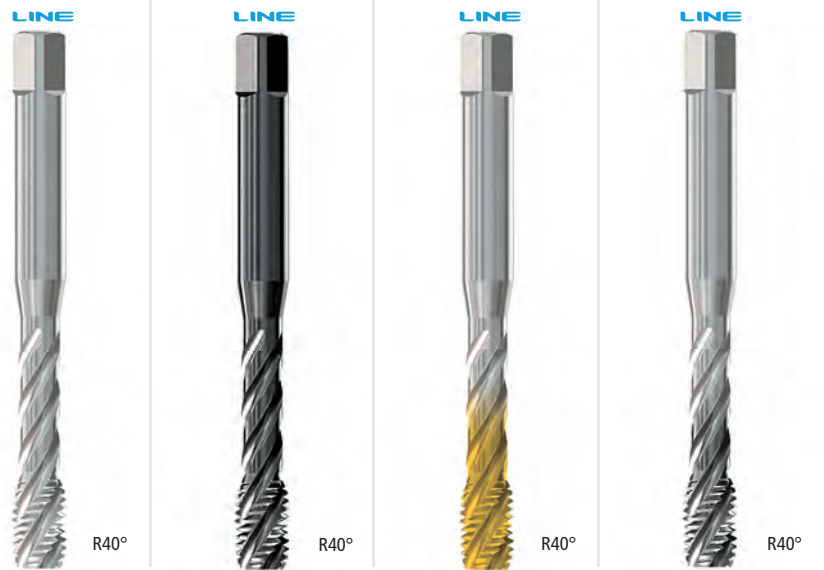
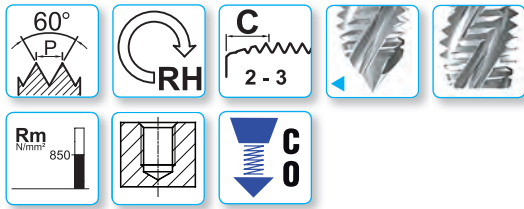
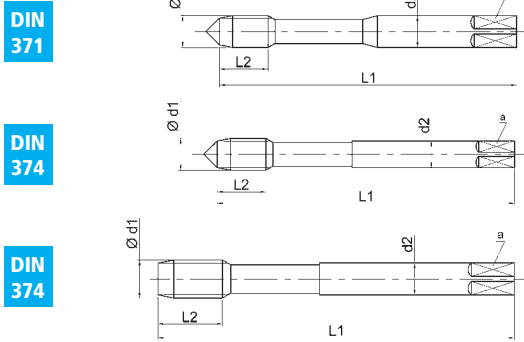

Profond. di filettatura - Thread depth - Profond. de filetage
 Materiale - Material - Matériau
 Tolleranza - Tolerance - Tolérance
 Trattamento superficiale - Surface treatment - Revêtement

2,5xD	2,5xD	2,5xD	2,5xD
HSSE	HSSE	HSSE	HSSE
2B	2B	2B	2B
BR	V	TiN	XP
1.1 1.2 1.3 1.4	1.1 1.2 1.3 1.4	1.1 1.2 1.3 1.4	1.1 1.2 1.3 1.4
4.1 4.2	4.1 4.2	3.3 3.4	2.1 2.2 3.3 3.4
5.1 5.2	5.1 5.2	4.1 4.2 4.3	4.2 4.3
		5.1 5.2	5.2

Numero gruppi materiali
 Material's groups number
 Nombre de groupes du matériau

DIN 371	Ød1 UNF	P TPI	Ø mm	L1	L2	d2 h9	a h12	Z	Icon
◀	6	40	3,505	56	7	4	3	3	2,95
◀	8	36	4,166	63	7	4,5	3,4	3	3,5
◀	10	32	4,826	70	8	6	4,9	3	4,1
◀	12	28	5,486	80	10	6	4,9	3	4,6
◀	1/4	28	6,350	80	10	7	5,5	3	5,5

CODICE - CODE			
E60UNF...	E60UNF...V	E60UNF...T	E60UNF...XP
•	○	○	○
•	○	○	○
•	○	○	○
○	○	○	○
•	○	○	○

DIN 374	Ød1 UNF	P TPI	Ø mm	L1	L2	d2 h9	a h12	Z	Icon
◀	1/4	28	6,350	80	10	4,5	3,4	3	5,5
	5/16	24	7,938	90	13	6	4,9	3	6,9
	3/8	24	9,525	90	15	7	5,5	3	8,5
	7/16	20	11,113	100	15	8	6,2	3	9,9
	1/2	20	12,700	100	13	9	7	3	11,5
	9/16	18	14,288	100	15	11	9	4	12,9
	5/8	18	15,875	100	15	12	9	4	14,5
	3/4	16	19,050	110	17	14	11	4	17,5
	7/8	14	22,225	125	18	18	14,5	4	20,4
	1"	12	25,400	140	22	18	14,5	4	23,25
	1"1/8	12	28,575	150	22	22	18	4	26,5
	1"1/4	12	31,750	150	22	22	18	5	29,5
	1"3/8	12	34,925	170	24	28	22	5	32,75
	1"1/2	12	38,100	170	24	28	22	6	36

CODICE - CODE			
E61UNF...	E61UNF...V	E61UNF...T	E61UNF...XP
○	○	○	○
•	○	○	○
•	○	○	○
•	○	○	○
•	○	○	○
○	○	○	○
•	○	○	○
•	○	○	○
○	○	○	○
•	○	○	○
○	○	○	○
○	○	○	○

Confezione / Box / Colis: 6 - 7/16: 10 pezzi / pcs
 1/2 - 9/16: 5 pezzi / pcs
 >9/16: singoli / single pcs

€ Pag. listino - Price list - Liste des prix

86	86	86	87
----	----	----	----

• Standard ○ Disponibilità da richiedere, prezzo a listino
 On enquiry, standard price-list / Stock à vérifier ★ Solo a richiesta
 Only on request / Sur demande

MASCHI A MACCHINA

MACHINE TAPS - TARAUDS MACHINE

DIN 371

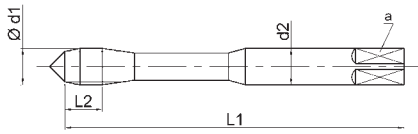

DIN 374

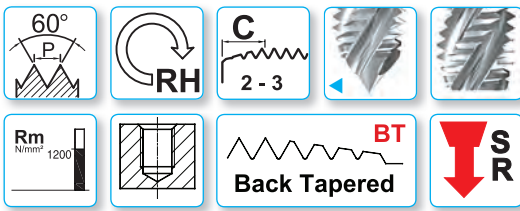
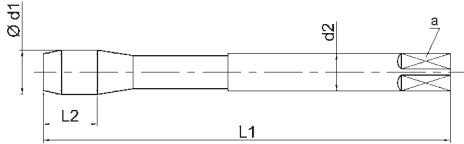

Profond. di filettatura - Thread depth - Profond. de filetage

Materiale - Material - Matériau

Tolleranza - Tolerance - Tolérance

Trattamento superficiale - Surface treatment - Revêtement

Numero gruppi materiali

Material's groups number

Nombre de groupes du matériau

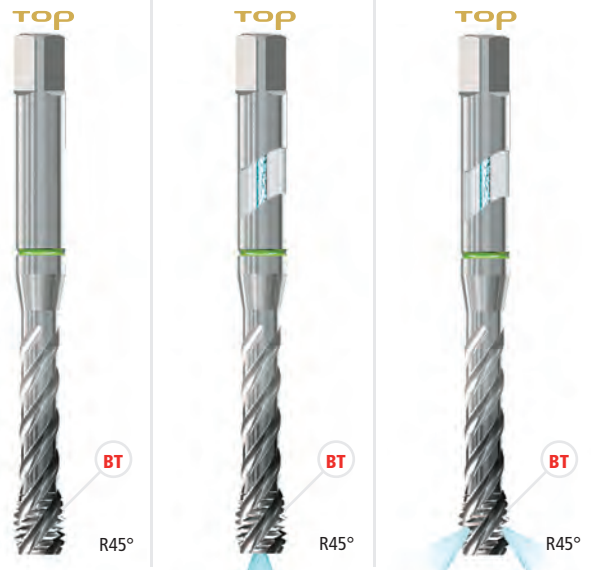

3xD	3,5xD	3,5xD
PM3	PM3	PM3
2BX	2BX	2BX
XP	XP	XP
1.1 1.2 1.3 1.4 1.5	1.1 1.2 1.3 1.4 1.5	1.1 1.2 1.3 1.4 1.5
2.1 2.2 2.3	2.1 2.2 2.3	2.1 2.2 2.3
3.3 3.4 4.2 4.3	3.3 3.4 4.2 4.3	3.3 3.4 4.2 4.3
5.2	5.2	5.2

DIN 371	Ød1 UNF	P TPI	Ø mm	L ₁	L ₂	d ₂ h9	a h12	Z	
4	48	2,845	56	5	3,5	2,7	3	2,4	
6	40	3,505	56	7	4	3	3	2,95	
8	36	4,166	63	7	4,5	3,4	3	3,5	
10	32	4,826	70	8	6	4,9	3	4,1	
1/4	28	6,350	80	10	7	5,5	3	5,5	

CODICE - CODE		
K82UNF...XP	K82UNF...FOR-XP	K82UNF...FORY-XP
○	-	-
○	-	-
○	-	-
○	-	-
○	○	○

DIN 374	Ød1 UNF	P TPI	Ø mm	L ₁	L ₂	d ₂ h9	a h12	Z	
5/16	24	7,938	90	13	6	4,9	3	6,9	
3/8	24	9,525	90	15	7	5,5	3	8,5	
7/16	20	11,113	100	15	8	6,2	3	9,9	
1/2	20	12,700	100	13	9	7	4	11,5	
9/16	18	14,288	100	15	11	9	4	12,9	
5/8	18	15,875	100	15	12	9	4	14,5	
3/4	16	19,050	110	17	14	11	4	17,5	
7/8	14	22,225	125	18	18	14,5	4	20,4	
1"	12	25,400	140	22	18	14,5	4	23,25	

CODICE - CODE		
K83UNF...XP	K83UNF...FOR-XP	K83UNF...FORY-XP
○	○	○
○	○	○
○	○	○
○	○	○
○	○	○
○	○	○
○	○	○
○	○	○
○	○	○

RACCOMANDATO per filettatura rigida
We recommend Syncro rigid threading
Recommandé pour le taraudage rigide



INOX

ACCIAIO INOSSIDABILE
 Stainless steel - Acier inoxydable

MASCHI A MACCHINA

MACHINE TAPS - TARAUDS MACHINE

DIN 371

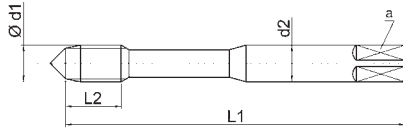

DIN 374

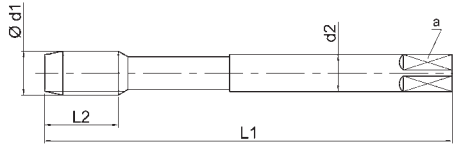

TOP



R48°

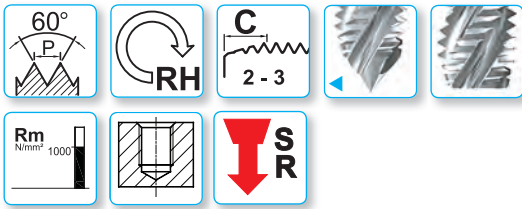

Profond. di filettatura - Thread depth - Profond. de filetage

3,5xD

Materiale - Material - Matériau

HSSV3

Tolleranza - Tolerance - Tolérance

2BX

Trattamento superficiale - Surface treatment - Revêtement

TXC

Numero gruppi materiali

Material's groups number

Nombre de groupes du matériau

1.3 1.4 1.5

2.1 2.2 2.3 2.4

DIN 371	Ød1 UNF	P TPI	Ø mm	L ₁	L ₂	d ₂ h9	a h12	Z	
◀	6	40	3,505	56	7	4	3	3	2,95
◀	8	36	4,166	63	7	4,5	3,4	3	3,5
◀	10	32	4,826	70	8	6	4,9	3	4,1
◀	1/4	28	6,350	80	10	7	5,5	3	5,5

CODICE - CODE	
V82UNF...TXC	
○	
○	
○	
○	

DIN 374	Ød1 UNF	P TPI	Ø mm	L ₁	L ₂	d ₂ h9	a h12	Z	
	5/16	24	7,938	90	13	6	4,9	3	6,9
	3/8	24	9,525	90	15	7	5,5	3	8,5
	7/16	20	11,113	100	15	8	6,2	3	9,9
	1/2	20	12,700	100	13	9	7	4	11,5
	9/16	18	14,288	100	15	11	9	4	12,9
	5/8	18	15,875	100	15	12	9	4	14,5
	3/4	16	19,050	110	17	14	11	4	17,5
	7/8	14	22,225	125	18	18	14,5	4	20,4
	1"	12	25,400	140	22	18	14,5	4	23,25

CODICE - CODE	
V83UNF...TXC	
○	
○	
○	
○	
○	
○	
○	
○	
○	

RACCOMANDATO
 per filettatura rigida
 We recommend
 Syncro rigid
 threading
 Recommandé
 pour le
 taraudage rigide



Confezione / Box / Colis:
 6 - 7/16: 10 pezzi / pcs
 1/2 - 9/16: 5 pezzi / pcs
 >9/16: singoli / single pcs

€ Pag. listino - Price list - Liste des prix

88

● Standard

○ Disponibilità da richiedere, prezzo a listino
 On enquiry, standard price-list / Stock à vérifier

★ Solo a richiesta
 Only on request / Sur demande

MASCHI A MACCHINA

MACHINE TAPS - TARAUDS MACHINE

DIN 371

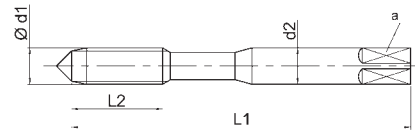

DIN 374

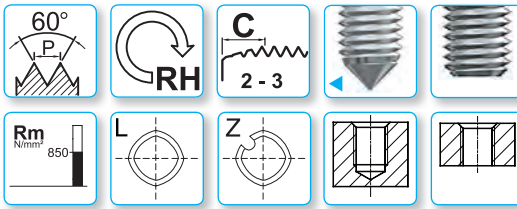
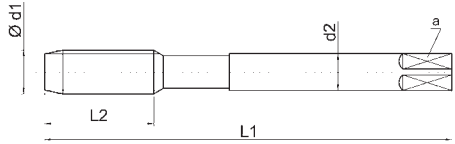

Profond. di filettatura - Thread depth - Profond. de filetage

Materiale - Material - Matériau

Tolleranza - Tolerance - Tolérance

Trattamento superficiale - Surface treatment - Revêtement

Numero gruppi materiali
Material's groups number
Nombre de groupes du matériau

LINE



LINE



LINE



LINE



3xD	3xD	3xD	3xD
HSSP	HSSP	HSSP	HSSP
2BX	2BX	2BX	2BX
BR	TiN	BR	TiN
1.1 1.2 1.3	1.1 1.2 1.3 1.4	1.1 1.2 1.3	1.1 1.2 1.3 1.4
4.1 4.2	2.1 2.2 2.3	4.1 4.2	2.1 2.2 2.3
	4.1 4.2 4.3		4.1 4.2 4.3
	5.1 5.2		5.1 5.2

DIN 371	$\varnothing d_1$ UNF	P TPI	\varnothing mm	L_1	L_2	d_2 h9	a h12	Z	
6	40	3,505	56	11	4	3	2	3,2	
8	36	4,166	63	13	4,5	3,4	4	3,85	
10	32	4,826	70	13	6	4,9	4	4,45	
1/4	28	6,350	80	16	7	5,5	5	5,9	
5/16	24	7,938	90	18	8	6,2	5	7,45	
3/8	24	9,525	90	15	10	8	5	9	

CODICE - CODE			
P2SCUNF...	P2SCUNF...T	P2CCUNF...	P2CCUNF...T
<input type="radio"/>	<input type="radio"/>	<input type="radio"/>	<input type="radio"/>
<input type="radio"/>	<input type="radio"/>	<input type="radio"/>	<input type="radio"/>
<input type="radio"/>	<input type="radio"/>	<input type="radio"/>	<input type="radio"/>
<input type="radio"/>	<input type="radio"/>	<input type="radio"/>	<input type="radio"/>
<input type="radio"/>	<input type="radio"/>	<input type="radio"/>	<input type="radio"/>

DIN 374	$\varnothing d_1$ UNF	P TPI	\varnothing mm	L_1	L_2	d_2 h9	a h12	Z	
7/16	20	11,113	100	20	8	6,2	5	10,5	
1/2	20	12,700	100	20	9	7	6	12,1	
9/16	18	14,288	100	22	11	9	6	13,7	
3/4	16	19,050	110	25	14	11	8	18,4	
1"	12	25,400	140	28	18	14,5	8	24,45	

CODICE - CODE			
P2SCUNF...	P2SCUNF...T	P2CCUNF...	P2CCUNF...T
<input type="radio"/>	<input type="radio"/>	<input type="radio"/>	<input type="radio"/>
<input type="radio"/>	<input type="radio"/>	<input type="radio"/>	<input type="radio"/>
<input type="radio"/>	<input type="radio"/>	<input type="radio"/>	<input type="radio"/>
<input type="radio"/>	<input type="radio"/>	<input type="radio"/>	<input type="radio"/>
<input type="radio"/>	<input type="radio"/>	<input type="radio"/>	<input type="radio"/>

Confezione / Box / Colis: M3 – M10: 10 pezzi / pcs M12 – M16: 5 pezzi / pcs	€ Pag. listino - Price list - Liste des prix	88	88	88	88
● Standard	○ Disponibilità da richiedere, prezzo a listino On enquiry, standard price-list / Stock à vérifier	★ Solo a richiesta Only on request / Sur demande			

ANSI / ASME B1.2

Calibri a tampone filettati passa / non passa

Thread plug gauges go/no-go
Calibres de filetage entre/n’entre pas

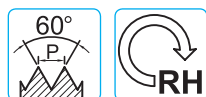

Tolleranza - Tolerance - Tolérance	2B
Trattamento superficiale - Surface treatment - Revêtement	BR

$\varnothing d1$ UNF	TPI	CODICE - CODE P-NPUNF...
6	40	○
8	36	○
10	32	○
12	28	○
1/4	28	○
5/16	24	○
3/8	24	○
7/16	20	○
1/2	20	○
9/16	18	○
5/8	18	○
3/4	16	○
7/8	14	○
1"	12	○
1"1/8	12	○
1"1/4	12	○
1"3/8	12	○
1"1/2	12	○

UNF

FILETTATURA AMERICANA UN

AMERICAN UNIFIED THREAD UN - FILETAGE AMÉRICAIN UN

UNF

Ø	PASSO - PITCH																						
	8	9	10	11	12	13	14	16	18	20	24	27	28	32	36	40	44	48	56	60	64	72	80
0																							UNF
1																					UNC	UNF	
2																			UNC	UNF			
3																		UNC	UNF				
4																UNC		UNF					
5															UNC	UNF							
6														UNC	UNF								
9/64																							
8														UNC	UNF								
11/64																							
10											UNC			UNF	UNS			UNS	UNS				
12											UNC		UNF	UNEF	UNS								
15/64																							
1/4										UNC	UNS		UNF	UNEF	UNS	UNS				UNS			
9/32																							
5/16									UNC		UNF			UNEF		UNS							
3/8								UNC	UNS	UN20	UNF	UNS	UN28	UNEF		UNS							
7/16							UNC			UNF	UNS	UNS	UNEF	UN32									
1/2						UNC				UNF	UNS	UNS	UNEF	UN32									
9/16					UNC					UNF			UNEF										
5/8				UNC						UN16	UNF	UN20	UNEF	UNS	UN28								
11/16										UN16	UNS		UNEF										
3/4			UNC							UNF	UNS	UNEF		UNS	UN28								
13/16										UN16			UNEF										
7/8		UNC			UN12					UNF	UN16	UNS	UNEF	UNS									
15/16										UN16	UNS												
1	UNC				UNF				UNS	UN16	UNS	UNEF	UNS		UN32								
1-1/16					UN12					UN16	UNEF	UN20											
1-1/8	UN8				UNF					UN16	UNEF	UN20											
1-3/16	UN8				UN12					UN16	UNEF												
1-1/4	UN8				UNF				UNS	UN16	UNEF	UN20											
1-5/16					UN12				UNS	UN16													
1-3/8	UN8				UNF						UNEF	UN20											
1-7/16					UN12						UNEF												
1-1/2	UN8				UNF					UN16	UNEF												
1-9/16																							
1-5/8	UN8				UN12																		
1-11/16																							
1-3/4	UN8				UN12																		
1-13/16																							
1-7/8	UN8				UN12							UN20											
1-15/16																							
2	UN8				UN12					UN16													
2-1/8																							
2-1/4	UN8																						
2-3/8																							
2-1/2	UN8				UN12																		
2-3/4																							
2-7/8	UN8																						
3	UN8																						

UNEF-UNS-UN...



UNEF UNS UN...

MASCHI A MACCHINA

MACHINE TAPS - TARAUDS MACHINE

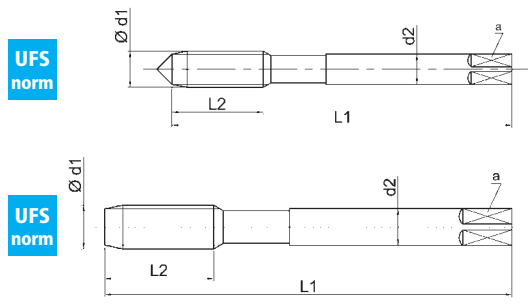

UFS
norm

UFS
norm

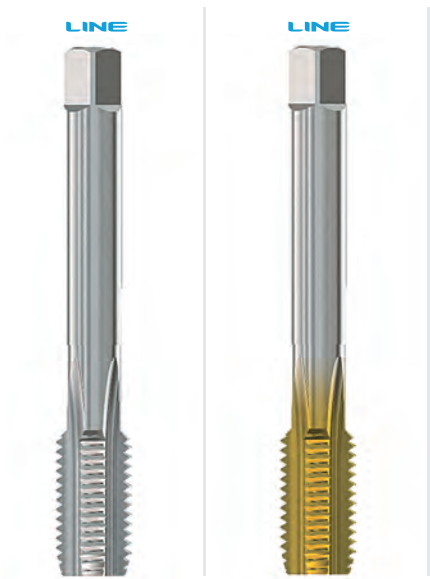
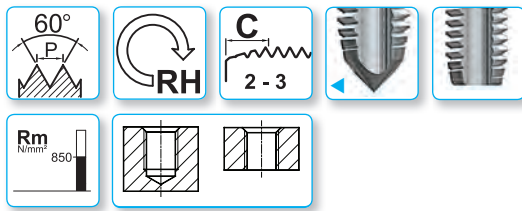

Profond. di filettatura - Thread depth - Profond. de filetage

Materiale - Material - Matériau

Tolleranza - Tolerance - Tolérance

Trattamento superficiale - Surface treatment - Revêtement

Numero gruppi materiali
Material's groups number
Nombre de groupes du matériau

1,5xD	1,5xD
HSSE	HSSE
2B	2B
BR	TiN
1.1 1.2 1.3 1.4 3.4	1.1 1.2 1.3 1.4 3.4
4.2 4.3 5.2 5.3	4.2 4.3 5.2 5.3
8.2	8.2

UFS norm	Ød1 UNEF	P TPI	Ø mm	L1	L2	d2 h9	a h12	Z	Image
1/4	32	6,350	80	16	4,5	3,4	3	5,55	
5/16	32	7,938	90	18	6	4,9	3	7,15	
3/8	32	9,525	90	15	7	5,5	3	8,7	
7/16	28	11,113	100	20	8	6,2	3	10,2	
1/2	28	12,700	100	20	9	7	3	11,8	
9/16	24	14,288	100	22	11	9	4	13,2	
5/8	24	15,875	100	22	12	9	4	14,8	
11/16	24	17,462	110	25	14	11	4	16,4	
3/4	20	19,050	110	25	14	11	4	17,8	
13/16	20	20,638	125	25	16	12	4	19,4	
7/8	20	22,225	125	25	18	14,5	4	20,95	
1"	20	25,400	140	28	18	14,5	4	24,15	
1"1/16	18	26,988	140	25	20	16	4	25,6	
1"1/8	18	28,575	150	28	22	18	4	27,15	
1"3/16	18	30,163	150	28	22	18	4	28,75	
1"1/4	18	31,750	150	28	22	18	5	30,3	
1"3/8	18	34,925	170	30	28	22	5	33,5	
1"7/16	18	36,513	170	30	28	22	6	35,1	
1"1/2	18	38,100	170	30	28	22	6	36,7	

CODICE - CODE	
E21UNEF...	E21UNEF...T
<input type="checkbox"/>	<input type="checkbox"/>
<input type="checkbox"/>	<input type="checkbox"/>
<input type="checkbox"/>	<input type="checkbox"/>
<input type="checkbox"/>	<input type="checkbox"/>
<input type="checkbox"/>	<input type="checkbox"/>
<input type="checkbox"/>	<input type="checkbox"/>
<input type="checkbox"/>	<input type="checkbox"/>
<input type="checkbox"/>	<input type="checkbox"/>
<input type="checkbox"/>	<input type="checkbox"/>
<input type="checkbox"/>	<input type="checkbox"/>
<input type="checkbox"/>	<input type="checkbox"/>
<input type="checkbox"/>	<input type="checkbox"/>
<input type="checkbox"/>	<input type="checkbox"/>
<input type="checkbox"/>	<input type="checkbox"/>
<input type="checkbox"/>	<input type="checkbox"/>
<input type="checkbox"/>	<input type="checkbox"/>
<input type="checkbox"/>	<input type="checkbox"/>
<input type="checkbox"/>	<input type="checkbox"/>
<input type="checkbox"/>	<input type="checkbox"/>
<input type="checkbox"/>	<input type="checkbox"/>
<input type="checkbox"/>	<input type="checkbox"/>
<input type="checkbox"/>	<input type="checkbox"/>
<input type="checkbox"/>	<input type="checkbox"/>
<input type="checkbox"/>	<input type="checkbox"/>

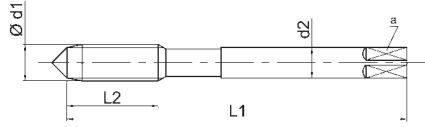
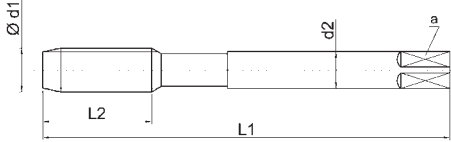
N
USO GENERALE
General purpose
UFS norm

UFS norm

LINE

LINE

Profond. di filettatura - Thread depth - Profond. de filetage
3xD
3xD
Materiale - Material - Matériau
HSSE
HSSE
Tolleranza - Tolerance - Tolérance
2B
2B
Trattamento superficiale - Surface treatment - Revêtement
BR
TiN
Numero gruppi materiali
Material's groups number
Nombre de groupes du matériau

1.1 1.2 1.3 1.4

1.1 1.2 1.3 1.4

4.1 4.2

3.3 3.4

5.1 5.2

4.1 4.2 4.3

5.1 5.2

UFS norm	Ød1 UNEF	P TPI	Ø mm	L ₁	L ₂	d ₂ h9	a h12	Z	
◀	1/4	32	6,350	80	16	4,5	3,4	3	5,55
◀	5/16	32	7,938	90	18	6	4,9	3	7,15
◀	3/8	32	9,525	90	15	7	5,5	3	8,7
	7/16	28	11,113	100	20	8	6,2	3	10,2
	1/2	28	12,700	100	20	9	7	3	11,8
	9/16	24	14,288	100	22	11	9	4	13,2
	5/8	24	15,875	100	22	12	9	4	14,8
	11/16	24	17,462	110	25	14	11	4	16,4
	3/4	20	19,050	110	25	14	11	4	17,8
	13/16	20	20,638	125	25	16	12	4	19,4
	7/8	20	22,225	125	25	18	14,5	4	20,95
	1"	20	25,400	140	28	18	14,5	4	24,15
	1"1/16	18	26,988	140	25	20	16	4	25,6
	1"1/8	18	28,575	150	28	22	18	4	27,15
	1"3/16	18	30,163	150	28	22	18	4	28,75
	1"1/4	18	31,750	150	28	22	18	5	30,3
	1"3/8	18	34,925	170	30	28	22	5	33,5
	1"7/16	18	36,513	170	30	28	22	6	35,1
	1"1/2	18	38,100	170	30	28	22	6	36,7

CODICE - CODE	
E25UNEF...	E25UNEF...T
<input type="radio"/>	<input type="radio"/>
<input type="radio"/>	<input type="radio"/>
<input type="radio"/>	<input type="radio"/>
<input type="radio"/>	<input type="radio"/>
<input type="radio"/>	<input type="radio"/>
<input type="radio"/>	<input type="radio"/>
<input type="radio"/>	<input type="radio"/>
<input type="radio"/>	<input type="radio"/>
<input type="radio"/>	<input type="radio"/>
<input type="radio"/>	<input type="radio"/>
<input type="radio"/>	<input type="radio"/>
<input type="radio"/>	<input type="radio"/>
<input type="radio"/>	<input type="radio"/>
<input type="radio"/>	<input type="radio"/>
<input type="radio"/>	<input type="radio"/>
<input type="radio"/>	<input type="radio"/>
<input type="radio"/>	<input type="radio"/>
<input type="radio"/>	<input type="radio"/>
<input type="radio"/>	<input type="radio"/>
<input type="radio"/>	<input type="radio"/>

Confezione: Singola Box: Single Colis: Unique	€ Pag. listino - Price list - Liste des prix	89	89	• Standard	<input type="radio"/> Disponibilità da richiedere, prezzo a listino On enquiry, standard price-list / Stock à vérifier	★ Solo a richiesta Only on request / Sur demande
---	--	-----------	-----------	------------	---	---

N

USO GENERALE

General purpose - Usage Général

MASCHI A MACCHINA

MACHINE TAPS - TARAUDS MACHINE

UFS norm

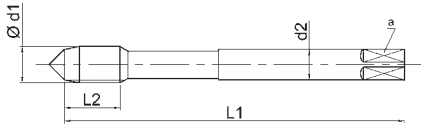

UFS norm

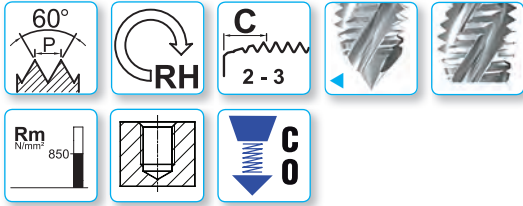
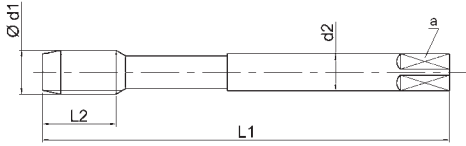

Profond. di filettatura - Thread depth - Profond. de filetage

Materiale - Material - Matériau

Tolleranza - Tolerance - Tolérance

Trattamento superficiale - Surface treatment - Revêtement

Numero gruppi materiali
Material's groups number
Nombre de groupes du matériau

LINE



R40°

LINE



R40°

2,5xD

2,5xD

HSSE

HSSE

2B

2B

BR

XP

1.1 1.2 1.3 1.4

4.1 4.2

5.1 5.2

1.1 1.2 1.3 1.4

2.1 2.2 3.3 3.4

4.2 4.3

5.2

UFS norm	Ø d1 UNEF	P TPI	Ø mm	L1	L2	d2 h9	a h12	Z	
◀	1/4	32	6,350	80	10	4,5	3,4	3	5,55
	5/16	32	7,938	90	13	6	4,9	3	7,15
	3/8	32	9,525	90	15	7	5,5	3	8,7
	7/16	28	11,113	100	15	8	6,2	3	10,2
	1/2	28	12,700	100	13	9	7	3	11,8
	9/16	24	14,288	100	15	11	9	4	13,2
	5/8	24	15,875	100	15	12	9	4	14,8
	11/16	24	17,462	110	17	14	11	4	16,4
	3/4	20	19,050	110	17	14	11	4	17,8
	13/16	20	20,638	125	18	16	12	4	19,4
	7/8	20	22,225	125	18	18	14,5	4	20,95
	1"	20	25,400	140	22	18	14,5	4	24,15
	1"1/16	18	26,988	140	20	20	16	4	25,6
	1"1/8	18	28,575	150	22	22	18	4	27,15
	1"3/16	18	30,163	150	22	22	18	4	28,75
	1"1/4	18	31,750	150	22	22	18	5	30,3
	1"3/8	18	34,925	170	24	28	22	5	33,5
	1"7/16	18	36,513	170	24	28	22	6	35,1
	1"1/2	18	38,100	170	24	28	22	6	36,7

CODICE - CODE			
E61UNEF...	E61UNEF...XP		
<input type="checkbox"/>	<input type="checkbox"/>		
<input type="checkbox"/>	<input type="checkbox"/>		
<input type="checkbox"/>	<input type="checkbox"/>		
<input type="checkbox"/>	<input type="checkbox"/>		
<input type="checkbox"/>	<input type="checkbox"/>		
<input type="checkbox"/>	<input type="checkbox"/>		
<input type="checkbox"/>	<input type="checkbox"/>		
<input type="checkbox"/>	<input type="checkbox"/>		
<input type="checkbox"/>	<input type="checkbox"/>		
<input type="checkbox"/>	<input type="checkbox"/>		
<input type="checkbox"/>	<input type="checkbox"/>		
<input type="checkbox"/>	<input type="checkbox"/>		
<input type="checkbox"/>	<input type="checkbox"/>		
<input type="checkbox"/>	<input type="checkbox"/>		
<input type="checkbox"/>	<input type="checkbox"/>		
<input type="checkbox"/>	<input type="checkbox"/>		
<input type="checkbox"/>	<input type="checkbox"/>		
<input type="checkbox"/>	<input type="checkbox"/>		
<input type="checkbox"/>	<input type="checkbox"/>		
<input type="checkbox"/>	<input type="checkbox"/>		

Confezione: Singola
Box: Single
Colis: Unique

€ Pag. listino - Price list - Liste des prix

89

89

● Standard

○ Disponibilità da richiedere, prezzo a listino
On enquiry, standard price-list / Stock à vérifier

★ Solo a richiesta
Only on request / Sur demande

N **USO GENERALE**
 General purpose - Usage Général

MASCHI A MACCHINA

MACHINE TAPS - TARAUDS MACHINE

UFS norm

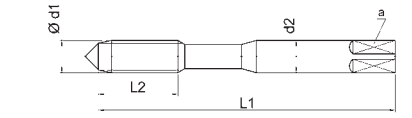

UFS norm

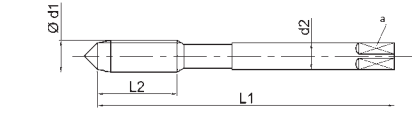

UFS norm

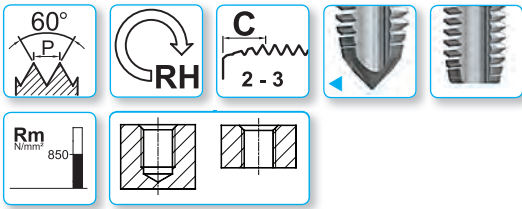
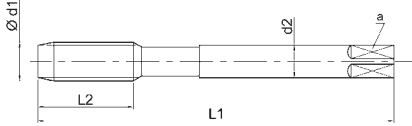

Profond. di filettatura - Thread depth - Profond. de filetage

Materiale - Material - Matériau

Tolleranza - Tolerance - Tolérance

Trattamento superficiale - Surface treatment - Revêtement

Numero gruppi materiali
 Material's groups number
 Nombre de groupes du matériau

1,5xD	1,5xD
HSSE	HSSE
2B	2B
BR	TiN
1.1 1.2 1.3 1.4 3.4	1.1 1.2 1.3 1.4 3.4
4.2 4.3 5.2 5.3	4.2 4.3 5.2 5.3
8.2	8.2

UFS norm	Ød1 UNS	P TPI	Ø mm	L ₁	L ₂	d ₂ h9	a h12	Z	Icon
◀	10	40	4,826	70	13	6	4,9	3	4,2
◀	10	48	4,826	70	13	6	4,9	3	4,3
◀	12	36	5,486	80	16	6	4,9	3	4,8
◀	1/4	24	6,350	80	16	7	5,5	3	5,3
◀	1/4	36	6,350	80	16	7	5,5	3	5,6
◀	1/4	40	6,350	80	16	7	5,5	3	5,7

CODICE - CODE	
E20-...UNS...	E20-...UNS...T
○	○
○	○
○	○
○	○
○	○
○	○

UFS norm	Ød1 UNS	P TPI	Ø mm	L ₁	L ₂	d ₂ h9	a h12	Z	Icon
◀	5/16	40	7,938	90	18	6	4,9	3	7,3
◀	3/8	18	9,525	100	20	7	5,5	3	8,1
◀	3/8	27	9,525	90	15	7	5,5	3	8,6
◀	3/8	40	9,525	90	15	7	5,5	3	8,9
	7/16	24	11,113	100	20	8	6,2	3	10,05
	7/16	27	11,113	100	20	8	6,2	3	10,2
	1/2	24	12,700	100	20	9	7	3	11,6
	1/2	27	12,700	100	20	9	7	3	11,75
	5/8	27	15,875	100	22	12	9	4	14,9
	11/16	18	17,462	110	25	14	11	4	16,05
	3/4	18	19,050	110	25	14	11	4	17,6
	7/8	18	22,225	125	25	18	14,5	4	20,8
	7/8	24	22,225	125	25	18	14,5	4	21,2
	15/16	18	23,813	140	25	18	14,5	4	22,4
	1"	14	25,400	140	28	18	14,5	4	23,6
	1"	18	25,400	140	28	18	14,5	4	24
	1"	24	25,400	140	28	18	14,5	4	24,3
	1"1/4	14	31,750	150	28	22	18	5	29,9
	1"5/16	14	33,338	170	30	28	22	5	31,5

CODICE - CODE	
E21-...UNS...	E21-...UNS...T
○	○
○	○
○	○
○	○
○	○
○	○
○	○
○	○
○	○
○	○
○	○
○	○
○	○
○	○
○	○
○	○
○	○
○	○
○	○
○	○
○	○
○	○

Confezione: Singola
 Box: Single
 Colis: Unique

€ Pag. listino - Price list - Liste des prix

90 90

● Standard ○ Disponibilità da richiedere, prezzo a listino
 On enquiry, standard price-list / Stock à vérifier

★ Solo a richiesta
 Only on request / Sur demande

N

USO GENERALE

General purpose - Usage Général

MASCHI A MACCHINA

MACHINE TAPS - TARAUDS MACHINE

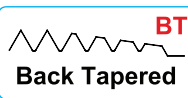
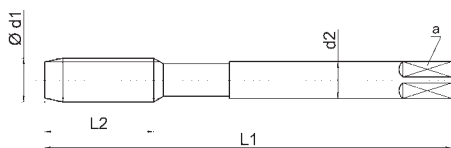

Profond. di filettatura - Thread depth - Profond. de filetage

Materiale - Material - Matériau

Tolleranza - Tolerance - Tolérance

Trattamento superficiale - Surface treatment - Revêtement

Numero gruppi materiali
Material's groups number
Nombre de groupes du matériau

1,5xD	1,5xD	2,5xD
HSSE	HSSE	HSSE
2B	2B	2B
BR	BR	BR
1.1 1.2 1.3 1.4 3.4	1.1 1.2 1.3 1.4 3.4	1.1 1.2 1.3 1.4 3.4
4.2 4.3 5.2 5.3	4.2 4.3 5.2 5.3	4.2 4.3 5.2 5.3
8.2	8.2	8.2

DIN 2184-1	Ød1	P	Ø	L1	L2	d2	a	Z	
8-UN	TPI		mm			h9	h12		
1"1/8	8	28,575	180	40	22	18	4	25,4	
1"1/4	8	31,750	180	40	22	18	4	28,6	
1"3/8	8	34,925	200	50	28	22	4	31,75	
1"1/2	8	38,100	200	50	28	22	4	34,9	
1"5/8	8	41,275	200	50	32	24	5	38,1	
1"3/4	8	44,450	200	50	36	29	5	41,3	
1"7/8	8	47,625	225	60	36	29	5	44,45	
2"	8	50,800	225	60	40	32	5	47,6	
2"1/4	8	57,150	250	65	45	35	6	54	
2"1/2	8	63,500	275	70	50	39	6	60,3	

UFS norm	Ød1	P	Ø	L1	L2	d2	a	Z	
12-UN	TPI		mm			h9	h12		
7/8	12	22,225	125	25	18	14,5	4	20,1	
1"1/16	12	26,988	140	25	20	16	4	24,9	
1"3/16	12	30,163	150	28	22	18	4	28	
1"5/16	12	33,338	170	30	28	22	5	31,2	
1"7/16	12	36,513	170	30	28	22	6	34,4	
1"5/8	12	41,275	170	30	32	24	6	39,2	
1"3/4	12	44,450	180	32	36	29	6	42,3	
2"	12	50,8	190	32	40	32	6	48,7	

UFS norm	Ød1	P	Ø	L1	L2	d2	a	Z	
16-UN	TPI		mm			h9	h12		
1"	16	25,400	140	28	18	14,5	4	23,8	
1"1/8	16	28,575	150	28	22	18	4	27	
1"1/4	16	31,750	150	28	22	18	5	30,15	
1"1/2	16	38,100	170	30	28	22	6	36,5	
2"	16	50,8	190	32	40	32	6	49,2	

CODICE - CODE		
E21-8UN...	E41-8UN...	E81-8UN...
○	○	○
○	○	○
○	○	○
○	○ (Z=5)	○ (Z=5)
○	○	○
○	○	○
○	○	○
○	○	○
○	○	○
○	○	○

RACCOMANDATO per filettatura rigida
We recommend Syncro rigid threading
Recommandé pour le taraudage rigide

CODICE - CODE		
E21-12UN...		
○		
○		
○		
○		
○		
○		
○		
○		
○		
○		

CODICE - CODE		
E21-16UN...		
○		
○		
○		
○		
○		

■ = Acciaio HSS / HSS Steel / Acier HSS

Confezione: Singola Box: Single Colis: Unique	€ Pag. listino - Price list - Liste des prix	91	91	91
	● Standard	○ Disponibilità da richiedere, prezzo a listino On enquiry, standard price-list / Stock à vérifier	★ Solo a richiesta Only on request / Sur demande	

N USO GENERALE
General purpose - Usage Général

MASCHI A MACCHINA

MACHINE TAPS - TARAUDS MACHINE

UFS norm

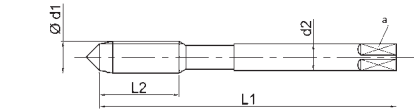

UFS norm

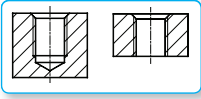
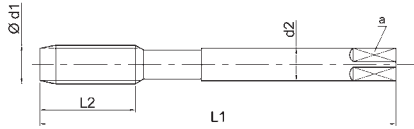

LINE



LINE



Profond. di filettatura - Thread depth - Profond. de filetage

Materiale - Material - Matériau

Tolleranza - Tolerance - Tolérance

Trattamento superficiale - Surface treatment - Revêtement

1,5xD	1,5xD
HSSE	HSSE
2B	2B
BR	TiN
1.1 1.2 1.3 1.4 3.4	1.1 1.2 1.3 1.4 3.4
4.2 4.3 5.2 5.3	4.2 4.3 5.2 5.3
8.2	8.2

Numero gruppi materiali
Material's groups number
Nombre de groupes du matériau

UFS norm	Ød1	P	Ø	L ₁	L ₂	d ₂ h9	a h12	Z	Icon
20-UN	TPI		mm						
3/8	20	20	9,525	100	20	7	5,5	3	8,3
5/8	20	20	15,875	100	22	12	9	4	14,6
1" 1/16	20	20	26,988	140	25	20	16	4	25,7
1" 1/8	20	20	28,575	150	28	22	18	4	27,3
1" 1/4	20	20	31,750	150	28	22	18	5	30,5
1" 3/8	20	20	34,925	170	30	28	22	5	33,7

CODICE - CODE	
E21-20UN...	E21-20UN...T
<input type="radio"/>	<input type="radio"/>
<input type="radio"/>	<input type="radio"/>
<input type="radio"/>	<input type="radio"/>
<input type="radio"/>	<input type="radio"/>
<input type="radio"/>	<input type="radio"/>
<input type="radio"/>	<input type="radio"/>

UFS norm	Ød1	P	Ø	L ₁	L ₂	d ₂ h9	a h12	Z	Icon
28-UN	TPI		mm						
3/8	28	28	9,525	90	15	7	5,5	3	8,6
5/8	28	28	15,875	100	22	12	9	4	15

CODICE - CODE	
E21-28UN...	E21-28UN...T
<input type="radio"/>	<input type="radio"/>
<input type="radio"/>	<input type="radio"/>

UFS norm	Ød1	P	Ø	L ₁	L ₂	d ₂ h9	a h12	Z	Icon
32-UN	TPI		mm						
7/16	32	32	11,113	100	20	8	6,2	3	10,3
1/2	32	32	12,700	100	20	9	7	3	11,9

CODICE - CODE	
E21-32UN...	E21-32UN...T
<input type="radio"/>	<input type="radio"/>
<input type="radio"/>	<input type="radio"/>

Confezione: Singola € Pag. listino - Price list - Liste des prix 91 91
 Box: Single ● Standard ○ Disponibilità da richiedere, prezzo a listino ★ Solo a richiesta
 Colis: Unique On enquiry, standard price-list / Stock à vérifier Only on request / Sur demande

GAS-Rp-NPSM-NPSF



MASCHI A MANO

HAND TAPS - TARAUDS MAIN

DIN
5157

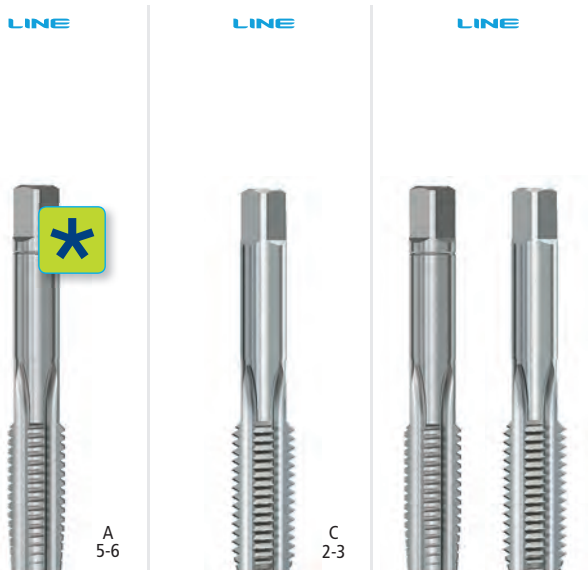
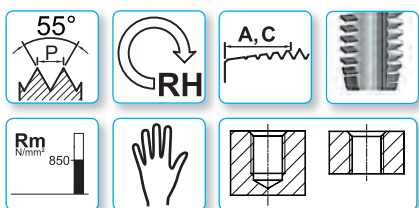
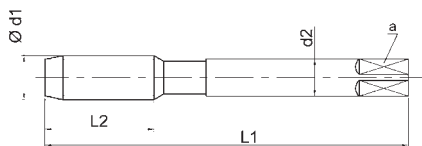

Profond. di filettatura - Thread depth - Profond. de filetage
 Materiale - Material - Matériau
 Tolleranza - Tolerance - Tolérance
 Trattamento superficiale - Surface treatment - Revêtement

2xD	2xD	2xD
HSS	HSS	HSS
-	ISO 228	ISO 228
BR	BR	BR
1.1 1.2 1.3 1.4	1.1 1.2 1.3 1.4	1.1 1.2 1.3 1.4
2.1 2.2 2.3 3.1 3.4	2.1 2.2 2.3 3.1 3.4	2.1 2.2 2.3 3.1 3.4
4.1 4.2 4.3 4.4	4.1 4.2 4.3 4.4	4.1 4.2 4.3 4.4
5.1 5.2 5.3	5.1 5.2 5.3	5.1 5.2 5.3

Numero gruppi materiali
 Material's groups number
 Nombre de groupes du matériau

DIN 5157	Ød1 GAS	P TPI	Ø mm	L ₁	L ₂	d ₂ h9	a h12	Z	
	1/8	28	9,73	63	18	7	5,5	3	8,8
	1/4	19	13,16	70	20	11	9	4	11,8
	3/8	19	16,66	70	20	12	9	4	15,25
	1/2	14	20,96	80	22	16	12	4	19
	5/8	14	22,91	80	22	18	14,5	4	21
	3/4	14	26,44	90	22	20	16	4	24,5
	7/8	14	30,20	90	22	22	18	4	28,25
	1"	11	33,25	100	25	25	20	5	30,75
	1 1/8	11	37,90	125	32	28	22	6	35,5
	1 1/4	11	41,91	125	32	32	24	6	39,5
	1 1/2	11	47,8	140	32	36	29	6	45,25
	1 3/4	11	53,75	140	32	40	32	6	51,10
	2"	11	59,61	160	36	45	35	6	57,2
	2 1/4	11	65,71	160	40	50	39	6	63,10
	2 1/2	11	75,18	160	40	50	39	8	72,6
	2 3/4	11	81,53	160	40	50	39	8	79,1
	3"	11	87,88	160	40	50	39	8	85,3

CODICE - CODE			
01G...	03G...	00G...	
○	○	○	
○	○	○	
○	○	○	
○	○	○	
○	○	○	
○	○	○	
○	○	○	
○	○	○	
○	○	○	
○	○	○	
○	○	○	
○	○	○	
○	○	○	
○	○	○	
○	○	○	
○	○	○	
○	○	○	
○	○	○	
○	○	○	
○	○	○	
○	○	○	
○	○	○	
○	○	○	
○	○	○	
○	○	○	

★ **Ad esaurimento scorte**
 Stock clearance - Stock épuisé

Confezione: Singola Box: Single Colis: Unique	€ Pag. listino - Price list - Liste des prix	92	92	92
	• Standard	○ Disponibilità da richiedere, prezzo a listino On enquiry, standard price-list / Stock à vérifier		★ Solo a richiesta Only on request / Sur demande

N USO GENERALE
General purpose - Usage Général

MASCHI A MACCHINA
MACHINE TAPS - TARAUDS MACHINE

DIN 5156

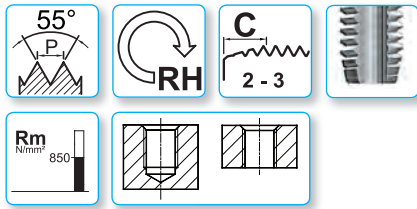
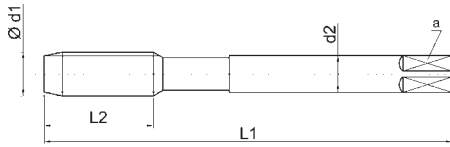

Profond. di filettatura - Thread depth - Profond. de filetage

Materiale - Material - Matériau

Tolleranza - Tolerance - Tolérance

Trattamento superficiale - Surface treatment - Revêtement

1,5xD

1,5xD

HSSE

HSSE

ISO 228

ISO 228

BR

TiN

Numero gruppi materiali

Material's groups number

Nombre de groupes du matériau

1.1 1.2 1.3 1.4 3.4

1.1 1.2 1.3 1.4 3.4

4.2 4.3 5.2 5.3

4.2 4.3 5.2 5.3

8.2

8.2

DIN 5156	Ød1 GAS	P TPI	Ø mm	L ₁	L ₂	d ₂ h9	a h12	Z	
	1/8	28	9,73	90	15	7	5,5	3	8,8
	1/4	19	13,16	100	22	11	9	3	11,8
	3/8	19	16,66	100	22	12	9	3	15,25
	1/2	14	20,96	125	25	16	12	4	19
	5/8	14	22,91	125	25	18	14,5	4	21
	3/4	14	26,44	140	25	20	16	4	24,5
	7/8	14	30,20	150	28	22	18	4	28,25
	1"	11	33,25	160	30	25	20	5	30,75
	1" 1/8	11	37,90	170	30	28	22	6	35,5
	1" 1/4	11	41,91	170	30	32	24	6	39,5
	1" 1/2	11	47,8	190	32	36	29	6	45,25
	1" 3/4	11	53,75	190	32	40	32	6	51,1
	2"	11	59,61	220	40	45	35	6	57,2
	2" 1/2	11	75,18	250	50	45	35	8	72,6

■ = Acciaio HSS / HSS Steel / Acier HSS

CODICE - CODE	
E21G...	E21G...T
•	○
•	○
•	○
•	○
○	○
•	○
•	○
•	○
•	○
•	•
•	•
○	•

Confezione / Box / Collis:
1/8 G: 10 pezzi / pcs
1/4 G – 3/8: 5 pezzi / pcs

€ Pag. listino - Price list - Liste des prix

93

93

● Standard

○ Disponibilità da richiedere, prezzo a listino
On enquiry, standard price-list / Stock à vérifier

★ Solo a richiesta
Only on request / Sur demande

MASCHI A MACCHINA

MACHINE TAPS - TARAUDS MACHINE

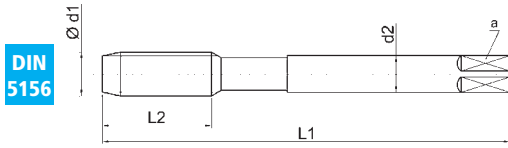

DIN 5156

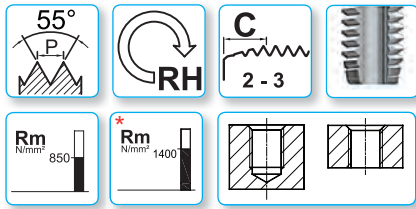

LINE



LINE



TOP



TOP



Profond. di filettatura - Thread depth - Profond. de filetage

Materiale - Material - Matériau

Tolleranza - Tolerance - Tolérance

Trattamento superficiale - Surface treatment - Revêtement

Al Si>10%,
Ottone / Brass / Laiton
Bronzo / Bronze / Bronze
truciolo corto / short chip /
coupeaux courts

Numero gruppi materiali
Material's groups number
Nombre de groupes du matériau

3xD

HSSE

ISO 228X

NQ

3.1 3.2 3.3 3.4 3.5

4.3 4.4 4.5 4.6 5.3

8.2 10.1

3xD

HSSE

ISO 228X

TiCN

3.1 3.2 3.3 3.4 3.5

4.3 4.4 4.5 4.6 5.3

8.2 10.1

3xD

PM3

ISO 228X

TiAIN

3.1 3.2 3.3 3.4 3.5

4.4 5.3 5.4

10.1

3,5xD

PM3

ISO 228X

TiAIN

3.1 3.2 3.3 3.4 3.5

4.4 5.3 5.4

10.1

DIN 5156	Ød1 GAS	P TPI	Ø mm	L ₁	L ₂	d ₂ h9	a h12	Z	
	1/8	28	9,73	90	15	7	5,5	4	8,8
	1/4	19	13,16	100	22	11	9	4	11,8
	3/8	19	16,66	100	22	12	9	4	15,25
	1/2	14	20,96	125	25	16	12	4	19
	5/8	14	22,91	125	25	18	14,5	4	21
	3/4	14	26,44	140	25	20	16	4	24,5
	7/8	14	30,20	150	28	22	18	4	28,25
	1"	11	33,25	160	30	25	20	5	30,75
	1 1/8	11	37,90	170	30	28	22	6	35,5
	1 1/4	11	41,91	170	30	32	24	6	39,5
■	1 1/2	11	47,8	190	32	36	29	6	45,25
	1/8	28	9,73	90	15	7	5,5	4	8,8
	1/4	19	13,16	100	22	11	9	4	11,8
	3/8	19	16,66	100	22	12	9	4	15,25
	1/2	14	20,96	125	25	16	12	6	19
	3/4	14	26,44	140	25	20	16	6	24,5

■ = Acciaio HSS / HSS Steel / Acier HSS

CODICE - CODE			
E27G...NQ	E27G...CT		
○	●		
○	●		
○	●		
○	●		
○	○		
○	○		
○	○		
○	○		
○	○		
○	○		
○	○		
○	○		
○	○		
		*K27G...TX	*K27G...FOR-TX
-	-	○	○
-	-	○	○
-	-	○	○
-	-	○	○
-	-	○	○

A richiesta:
On request:
Sur demande:

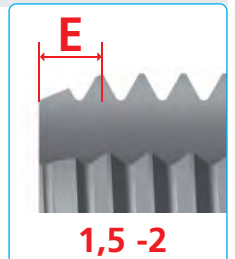

Confezione / Box / Colis:
1/8 G: 10 pezzi / pcs
1/4 G - 3/8 G: 5 pezzi / pcs

€ Pag. listino - Price list - Liste des prix
● Standard

93
○ Disponibilità da richiedere, prezzo a listino
On enquiry, standard price-list / Stock à vérifier

93
★ Solo a richiesta
Only on request / Sur demande

N

USO GENERALE

General purpose - Usage Général

MASCHI A MACCHINA

MACHINE TAPS - TARAUDS MACHINE

DIN 5156

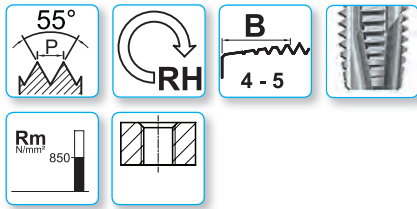
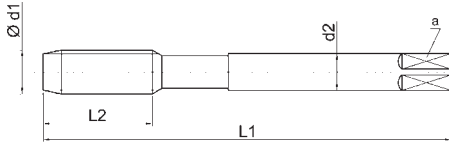

Profond. di filettatura - Thread depth - Profond. de filetage	3xD	3xD	3xD	3xD
Materiale - Material - Matériau	HSSE	HSSE	HSSE	HSSE
Tolleranza - Tolerance - Tolérance	ISO 228	ISO 228	ISO 228	ISO 228
Trattamento superficiale - Surface treatment - Revêtement	BR	V	TiN	XP
Numero gruppi materiali Material's groups number Nombre de groupes du matériau	1.1 1.2 1.3 1.4 4.1 4.2 5.1 5.2	1.1 1.2 1.3 1.4 4.1 4.2 5.1 5.2 6.1 7.1	1.1 1.2 1.3 1.4 3.3 3.4 4.1 4.2 4.3 5.1 5.2	1.1 1.2 1.3 1.4 2.1 2.2 3.3 3.4 4.2 4.3 5.2

DIN 5156	Ød1 GAS	P TPI	Ø mm	L ₁	L ₂	d ₂ h9	a h12	Z	Icon
	1/8	28	9,73	90	15	7	5,5	3	8,8
	1/4	19	13,16	100	22	11	9	3	11,8
	3/8	19	16,66	100	22	12	9	4	15,25
	1/2	14	20,96	125	25	16	12	4	19
	5/8	14	22,91	125	25	18	14,5	4	21
	3/4	14	26,44	140	25	20	16	4	24,5
	7/8	14	30,20	150	28	22	18	4	28,25
	1"	11	33,25	160	30	25	20	5	30,75
	1" 1/8	11	37,90	170	30	28	22	6	35,5
	1" 1/4	11	41,91	170	30	32	24	6	39,5
	1" 1/2	11	47,8	190	32	36	29	6	45,25
	1" 3/4	11	53,75	190	32	40	32	6	51,10
	2"	11	59,61	220	40	45	35	6	57,2

■ = Acciaio HSS / HSS Steel / Acier HSS

CODICE - CODE			
E25G...	E25G...V	E25G...T	E25G...XP
●	○	○	○
●	○	○	○
●	○	○	○
●	○	○	○
○	○	○	○
○	○	○	○
○	○	○	○
○	○	○	○
○	○	○	○
○	○	○	○
○	○	○	○
○	○	○	○
○	○	○	○
○	○	○	○
○	○	○	○
○	○	○	○
○	○	○	○
○	○	○	○

Confezione / Box / Collis: 1/8 G: 10 pezzi / pcs 1/4 G - 3/8 G: 5 pezzi / pcs	€ Pag. listino - Price list - Liste des prix	93	93	94	94
	● Standard	○ Disponibilità da richiedere, prezzo a listino On enquiry, standard price-list / Stock à vérifier		★ Solo a richiesta Only on request / Sur demande	

GAS

MASCHI A MACCHINA

MACHINE TAPS - TARAUDS MACHINE

U

APPLICAZIONI UNIVERSALI R ≤ 1200 N/mm²
 Universal R ≤ 1200 N/mm² - Universal R ≤ 1200 N/mm²

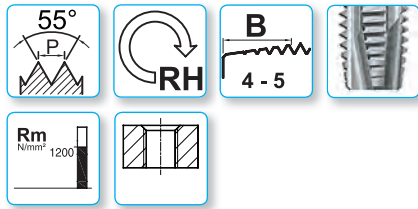
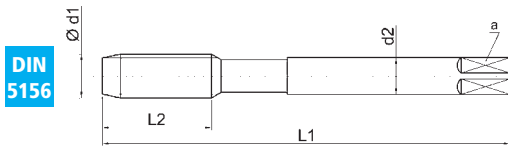

Profond. di filettatura - Thread depth - Profond. de filetage

Materiale - Material - Matériau

Tolleranza - Tolerance - Tolérance

Trattamento superficiale - Surface treatment - Revêtement

Al Si > 10%,
 Ottone / Brass / Laiton
 Bronzo / Bronze / Bronze
 truciolo corto / short chip /
 coupeaux courts

Numero gruppi materiali
 Material's groups number
 Nombre de groupes du matériau

3xD	3,5xD
PM3	PM3
ISO 228X	ISO 228X
XP	XP
1.1 1.2 1.3 1.4 1.5	1.1 1.2 1.3 1.4 1.5
2.1 2.2 2.3	2.1 2.2 2.3
3.3 3.4 4.2 4.3	3.3 3.4 4.2 4.3
5.2	5.2

DIN 5156	Ø d1 GAS	P TPI	Ø mm	L ₁	L ₂	d ₂ h9	a h12	Z	
	1/8	28	9,73	90	15	7	5,5	3	8,8
	1/4	19	13,16	100	22	11	9	4	11,8
	3/8	19	16,66	100	22	12	9	4	15,25
	1/2	14	20,96	125	25	16	12	4	19
	3/4	14	26,44	140	25	20	16	4	24,5

CODICE - CODE	
K25G...XP	K25G...FORY-XP
○	○
○	○
○	○
○	○
○	○

Confezione / Box / Colis:
 1/8 G: 10 pezzi / pcs
 1/4 G - 3/8 G: 5 pezzi / pcs

€ Pag. listino - Price list - Liste des prix
 • Standard

94
 ○ Disponibilità da richiedere, prezzo a listino
 On enquiry, standard price-list / Stock à vérifier

94
 ★ Solo a richiesta
 Only on request / Sur demande

MASCHI A MACCHINA

MACHINE TAPS - TARAUDS MACHINE

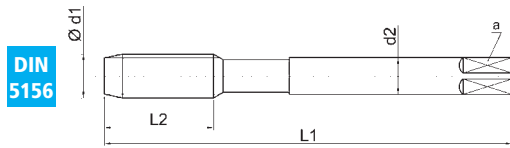

DIN 5156

TOP



Profond. di filettatura - Thread depth - Profond. de filetage

Materiale - Material - Matériau

Tolleranza - Tolerance - Tolérance

Trattamento superficiale - Surface treatment - Revêtement

3xD

HSSV3

ISO 228X

TXC

1.3 1.4 1.5

2.1 2.2 2.3 2.4

Numero gruppi materiali
 Material's groups number
 Nombre de groupes du matériau

GAS

DIN 5156	Ød1 GAS	P TPI	Ø mm	L ₁	L ₂	d ₂ h9	a h12	Z	
	1/8	28	9,73	90	15	7	5,5	3	8,8
	1/4	19	13,16	100	22	11	9	4	11,8
	3/8	19	16,66	100	22	12	9	4	15,25
	1/2	14	20,96	125	25	16	12	4	19
	3/4	14	26,44	140	25	20	16	4	24,5

CODICE - CODE

V25G...TXC

-
-
-
-
-

Confezione / Box / Colis:
 1/8 G: 10 pezzi / pcs
 1/4 G - 3/8 G: 5 pezzi / pcs

€ Pag. listino - Price list - Liste des prix

94

● Standard

○ Disponibilità da richiedere, prezzo a listino
 On enquiry, standard price-list / Stock à vérifier

★ Solo a richiesta
 Only on request / Sur demande

N **USO GENERALE**
General purpose - Usage Général

MASCHI A MACCHINA
MACHINE TAPS - TARAUDS MACHINE

DIN 5156

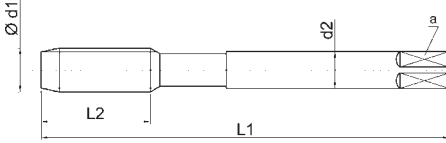

55°
RH
C
2 - 3
Rm
850



Profond. di filettatura - Thread depth - Profond. de filetage	1,5xD	1,5xD	1,5xD	1,5xD
Materiale - Material - Matériau	HSSE	HSSE	HSSE	HSSE
Tolleranza - Tolerance - Tolérance	ISO 228	ISO 228	ISO 228	ISO228+0,05
Trattamento superficiale - Surface treatment - Revêtement	BR	V	TiN	BR
Numero gruppi materiali Material's groups number Nombre de groupes du matériau	1.1 1.2 1.3 1.4 4.1 4.2 5.1 5.2	1.1 1.2 1.3 1.4 4.1 4.2 5.1 5.2 6.1 7.1	1.1 1.2 1.3 1.4 3.3 3.4 4.1 4.2 4.3 5.1 5.2	1.1 1.2 1.3 1.4 4.1 4.2 5.1 5.2

DIN 5156	Ød1 GAS	P TPI	Ø mm	L1	L2	d2 h9	a h12	Z
	1/8	28	9,73	90	15	7	5,5	3 8,8
	1/4	19	13,16	100	22	11	9	3 11,8
	3/8	19	16,66	100	22	12	9	3 15,25
	1/2	14	20,96	125	25	16	12	4 19
	5/8	14	22,91	125	25	18	14,5	4 21
	3/4	14	26,44	140	25	20	16	4 24,5
	7/8	14	30,20	150	28	22	18	4 28,25
	1"	11	33,25	160	30	25	20	5 30,75
	1" 1/8	11	37,90	170	30	28	22	6 35,5
	1" 1/4	11	41,91	170	30	32	24	6 39,5
	1" 1/2	11	47,8	190	32	36	29	6 45,25
	1" 3/4	11	53,75	190	32	40	32	6 51,4
	2"	11	59,61	220	40	45	35	6 57,2
	2" 1/2	11	75,18	250	50	45	35	8 72,8

■ = Acciaio HSS / HSS Steel / Acier HSS

Confezione / Box / Collis:	€ Pag. listino - Price list - Liste des prix	94	95	95	95
1/8 G: 10 pezzi / pcs 1/4 G - 3/8 G: 5 pezzi / pcs	● Standard ○ Disponibilità da richiedere, prezzo a listino On enquiry, standard price-list / Stock à vérifier			★ Solo a richiesta Only on request / Sur demande	

N **USO GENERALE**
 General purpose - Usage Général

MASCHI A MACCHINA

MACHINE TAPS - TARAUDS MACHINE

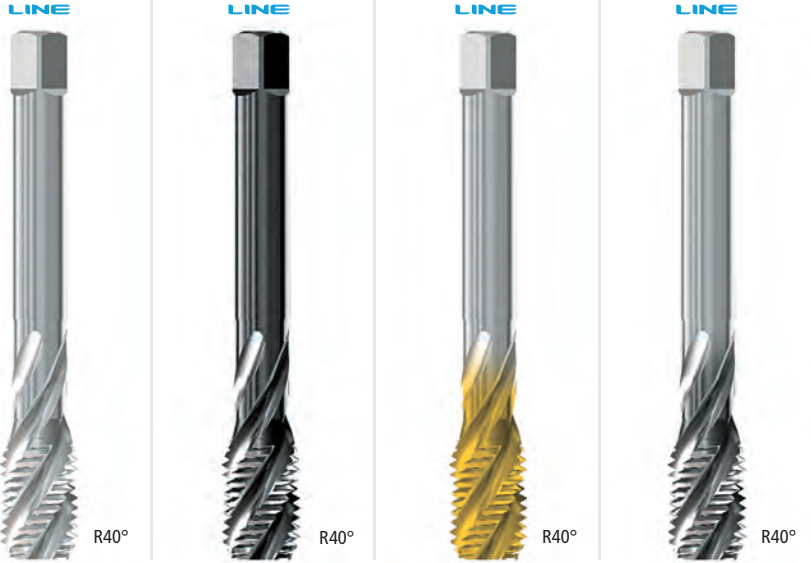
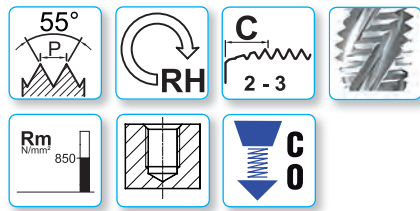
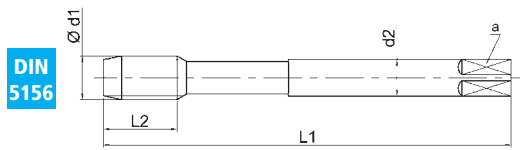

Profond. di filettatura - Thread depth - Profond. de filetage

Materiale - Material - Matériau

Tolleranza - Tolerance - Tolérance

Trattamento superficiale - Surface treatment - Revêtement

2,5xD	2,5xD	2,5xD	2,5xD
HSSE	HSSE	HSSE	HSSE
ISO 228	ISO 228	ISO 228	ISO 228
BR	V	TiN	XP
1.1 1.2 1.3 1.4	1.1 1.2 1.3 1.4	1.1 1.2 1.3 1.4	1.1 1.2 1.3 1.4
4.1 4.2	4.1 4.2	3.3 3.4	2.1 2.2 3.3 3.4
5.1 5.2	5.1 5.2	4.1 4.2 4.3	4.2 4.3
		5.1 5.2	5.2

Numero gruppi materiali
 Material's groups number
 Nombre de groupes du matériau

DIN 5156	Ød1 GAS	P TPI	Ø mm	L ₁	L ₂	d ₂ h9	a h12	Z	
	1/8	28	9,73	90	15	7	5,5	3	8,8
	1/4	19	13,16	100	15	11	9	3	11,8
	3/8	19	16,66	100	15	12	9	4	15,25
	1/2	14	20,96	125	18	16	12	4	19
	5/8	14	22,91	125	18	18	14,5	4	21
	3/4	14	26,44	140	20	20	16	4	24,5
	7/8	14	30,20	150	22	22	18	4	28,25
	1"	11	33,25	160	24	25	20	5	30,75
	1 1/8	11	37,90	170	24	28	22	6	35,5
	1 1/4	11	41,91	170	24	32	24	6	39,5
■	1 1/2	11	47,8	190	27	36	29	6	45,25
■	1 3/4	11	53,75	190	27	40	32	6	51,10
■	2"	11	59,61	220	32	45	35	6	57,2

■ = Acciaio HSS / HSS Steel / Acier HSS

CODICE - CODE			
E61G...	E61G...V	E61G...T	E61G...XP
●	○	○	○
●	○	○	○
●	○	○	○
●	○	○	○
○	○	○	○
●	○	○	○
○	○	○	○
○	○	○	○
○	○	○	○
○	○	○	○
○	○	○	○
○	○	○	○
○	○	○	○
○	○	○	○
○	○	○	○
○	○	○	○
○	○	○	○
○	○	○	○
○	○	○	○
○	○	○	○
○	○	○	○
○	○	○	○
○	○	○	○

U **APPLICAZIONI UNIVERSALI R ≤ 1200 N/mm²**
 Universal R ≤ 1200 N/mm² - Universal R ≤ 1200 N/mm²

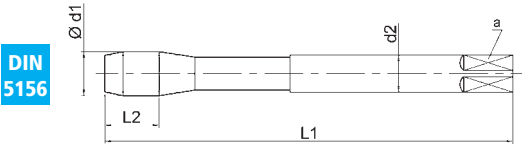
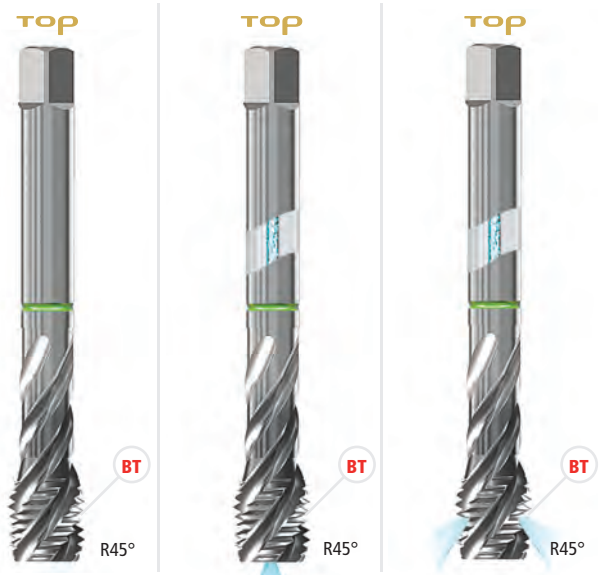
MASCHI A MACCHINA
 MACHINE TAPS - TARAUDS MACHINE



Profond. di filettatura - Thread depth - Profond. de filetage

Materiale - Material - Matériau

Tolleranza - Tolerance - Tolérance

Trattamento superficiale - Surface treatment - Revêtement

Numero gruppi materiali
Material's groups number
Nombre de groupes du matériau

3xD	3,5xD	3,5xD
PM3	PM3	PM3
ISO 228X	ISO 228X	ISO 228X
XP	XP	XP
1.1 1.2 1.3 1.4 1.5	1.1 1.2 1.3 1.4 1.5	1.1 1.2 1.3 1.4 1.5
2.1 2.2 2.3	2.1 2.2 2.3	2.1 2.2 2.3
3.3 3.4 4.2 4.3	3.3 3.4 4.2 4.3	3.3 3.4 4.2 4.3
5.2	5.2	5.2

DIN 5156	Ød1 GAS	P TPI	Ø mm	L ₁	L ₂	d ₂ h9	a h12	Z	Image
	1/8	28	9,73	90	15	7	5,5	3	8,8
	1/4	19	13,16	100	15	11	9	3	11,8
	3/8	19	16,66	100	15	12	9	4	15,25
	1/2	14	20,96	125	18	16	12	4	19
	3/4	14	26,44	140	20	20	16	4	24,5
	1"	11	33,25	160	24	25	20	5	30,75

CODICE - CODE		
K83G...XP	K83G...FOR-XP	K83G...FOR-XP
<input type="radio"/>	<input type="radio"/>	<input type="radio"/>
<input type="radio"/>	<input type="radio"/>	<input type="radio"/>
<input type="radio"/>	<input type="radio"/>	<input type="radio"/>
<input type="radio"/>	<input type="radio"/>	<input type="radio"/>
<input type="radio"/>	<input type="radio"/>	<input type="radio"/>
<input type="radio"/>	<input type="radio"/>	<input type="radio"/>

RACCOMANDATO per filettatura rigida

We recommend Syncro rigid threading

Recommandé pour le taraudage rigide

Confezione / Box / Collis: 1/8 G: 10 pezzi / pcs 1/4 G - 3/8 G: 5 pezzi / pcs	€ Pag. listino - Price list - Liste des prix ● Standard	96 ○ Disponibilità da richiedere, prezzo a listino On enquiry, standard price-list / Stock à vérifier	96 ★ Solo a richiesta Only on request / Sur demande
---	--	---	---

MASCHI A MACCHINA

MACHINE TAPS - TARAUDS MACHINE

SYNCHRO RIGID**MASCHIATURA RIGIDA SINCRONIZZATA**
Rigid Tapping Synchro - Taraudage rigide synchronisé

UFS norm

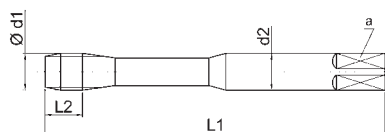

55° P RH C 2-3
 Rm N/mm² 1200
 BT Back Tapered
 SR



Profond. di filettatura - Thread depth - Profond. de filetage

2,5xD

3xD

Materiale - Material - Matériau

PM3

PM3

Tolleranza - Tolerance - Tolérance

ISO 228X

ISO 228X

Trattamento superficiale - Surface treatment - Revêtement

TXC

TXC

Numero gruppi materiali
Material's groups number
Nombre de groupes du matériau

1.1	1.2	1.3	1.4	1.5	1.1	1.2	1.3	1.4	1.5		
2.1	2.2	2.3	2.4	3.3	3.4	2.1	2.2	2.3	2.4	3.3	3.4
4.2	4.3	5.2				4.2	4.3	5.2			

GAS

UFS norm	Ød1 GAS	P TPI	Ø mm	L1	L2 10xP	d2 h6	a h12	Z	
	1/8	28	9,73	90	10	10	8	3	8,8
	1/4	19	13,16	100	13,5	12	9	3	11,8
	3/8	19	16,66	100	13,5	16	12	4	15,25
	1/2	14	20,96	125	18	20	16	4	19

CODICE - CODE

S80G...TXC

S80G...FOR-TXC

○

○

○

○

○

○

○

○

A richiesta:
On request:
Sur demande:

Con Weldon DIN1835 B

Confezione: Singola
Box: Single
Colis: Unique

€ Pag. listino - Price list - Liste des prix

96

96

• Standard

○ Disponibilità da richiedere, prezzo a listino
On enquiry, standard price-list / Stock à vérifier★ Solo a richiesta
Only on request / Sur demande

INOX
ACCIAIO INOSSIDABILE

Stainless steel - Acier inoxydable

MASCHI A MACCHINA

MACHINE TAPS - TARAUDS MACHINE

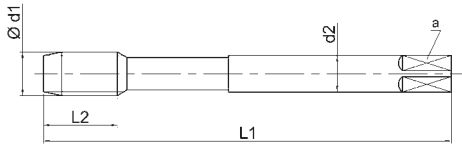
DIN 5156

TOP

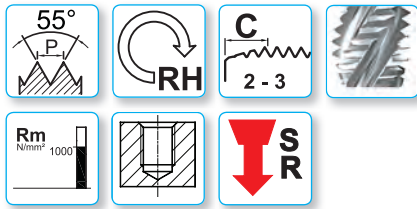
R48°



Profond. di filettatura - Thread depth - Profond. de filetage

3,5xD

Materiale - Material - Matériau

HSSV3

Tolleranza - Tolerance - Tolérance

ISO 228X

Trattamento superficiale - Surface treatment - Revêtement

TXC

Numero gruppi materiali

Material's groups number

Nombre de groupes du matériau

1.3 1.4 1.5

2.1 2.2 2.3 2.4

DIN 5156	Ød1 GAS	P TPI	Ø mm	L ₁	L ₂	d ₂ h9	a h12	Z	
	1/8	28	9,73	90	15	7	5,5	3	8,8
	1/4	19	13,16	100	15	11	9	3	11,8
	3/8	19	16,66	100	15	12	9	4	15,25
	1/2	14	20,96	125	18	16	12	4	19
	3/4	14	26,44	140	20	20	16	4	24,5
	1"	11	33,25	160	24	25	20	5	30,75

CODICE - CODE

V83G...TXC

-
-
-
-
-
-

 RACCOMANDATO per filettatura rigida
 We recommend Syncro rigid threading
 Recommandé pour le taraudage rigide

 Confezione / Box / Colis:
 6 - 7/16: 10 pezzi / pcs
 1/2 - 9/16: 5 pezzi / pcs
 Oltre / up: singoli / single pcs

€ Pag. listino - Price list - Liste des prix

96

● Standard

 ○ Disponibilità da richiedere, prezzo a listino
 On enquiry, standard price-list / Stock à vérifier

 ★ Solo a richiesta
 Only on request / Sur demande

MASCHI A MACCHINA

MACHINE TAPS - TARAUDS MACHINE

P - SERIES

MASCHI A RULLARE

Roll form taps - Tarauds à refouler

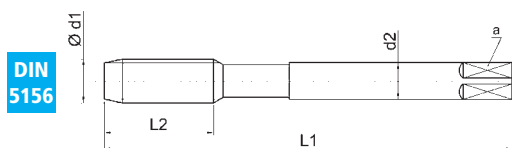

DIN 5156

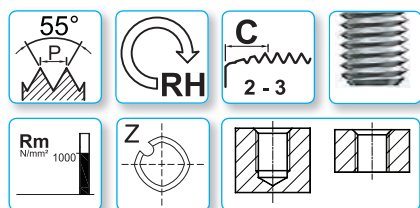

LINE

LINE

TOP

TOP



Profond. di filettatura - Thread depth - Profond. de filetage

Materiale - Material - Matériau

Tolleranza - Tolerance - Tolérance

Trattamento superficiale - Surface treatment - Revêtement

Numero gruppi materiali

Material's groups number
 Nombre de groupes du matériau

3xD	3xD	3xD	3xD
HSSP	HSSP	PM3	PM3
ISO 228X	ISO 228X	ISO 228X	ISO 228X
BR	TiN	TiN-G	TiN-G
1.1 1.2 1.3	1.1 1.2 1.3 1.4	1.1 1.2 1.3 1.4 1.5	1.1 1.2 1.3 1.4 1.5
4.1 4.2	2.1 2.2 2.3	2.1 2.2 2.3 2.4	2.1 2.2 2.3 2.4
	4.1 4.2 4.3	4.1 4.2 4.3	4.1 4.2 4.3
	5.1 5.2	5.1 5.2 7.1 7.2	5.1 5.2 7.1 7.2

DIN 5156	$\varnothing d1$ GAS	P TPI	\varnothing mm	L_1	L_2	d_2 h9	a h12	Z	
	1/8	28	9,73	90	15	7	5,5	5	9,25
	1/4	19	13,16	100	22	11	9	6	12,5
	3/8	19	16,66	100	22	12	9	6	16
	1/2	14	20,96	125	25	16	12	8	20
	3/4	14	26,44	140	25	20	16	8	25,5

CODICE - CODE

P2CCG...	P2CCG...T	X2CCG...TG	X2CCG...FOR-TG
•	○	•	○
•	○	•	○
•	○	•	○
•	○	•	○
○	○	○	○



Ad esaurimento scorte
 Stock clearance - Stock épuisé

Vedi nuova serie
 See new series
 Voir nouvelle série
 K-ROLL pag. XLI

Confezione: Singola
 Box: Single
 Colis: Unique

€ Pag. listino - Price list - Liste des prix

96

96

96

96

• Standard

○ Disponibilità da richiedere, prezzo a listino
 On enquiry, standard price-list / Stock à vérifier

★ Solo a richiesta
 Only on request / Sur demande

NPSM NPSF

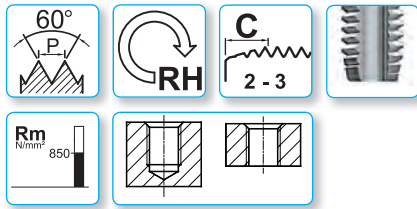
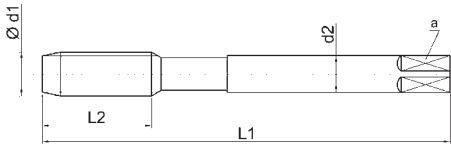

N
USO GENERALE
General purpose - Usage Général
MASCHI A MACCHINA
MACHINE TAPS - TARAUDS MACHINE
DIN 5156

Profond. di filettatura - Thread depth - Profond. de filetage
Materiale - Material - Matériau
Tolleranza - Tolerance - Tolérance
Trattamento superficiale - Surface treatment - Revêtement
1,5xD
1,5xD
HSSE
HSSE
-
-
BR
TiN
Numero gruppi materiali
Material's groups number
Nombre de groupes du matériau
1.1 1.2 1.3 1.4 3.4
1.1 1.2 1.3 1.4 3.4
4.2 4.3 5.2 5.3
4.2 4.3 5.2 5.3
8.2
8.2

DIN 5156	Ød1	P TPI	Ø mm	L ₁	L ₂	d ₂ h9	a h12	F
1/8	27	9,929	90	15	7	5,5	8,7	
1/4	18	13,236	100	22	11	9	11,30	
3/8	18	16,673	100	22	12	9	14,7	
1/2	14	20,819	125	25	16	12	18,2	
3/4	14	26,166	140	25	20	16	23,50	
1"	11,5	32,718	160	30	25	20	29,50	

CODICE - CODE
E21NPSF...
E21NPSF...T

Filettatura a tenuta cilindrica, accoppiata con filettatura esterna conica NPTF.

Dryseal internal straight pipe thread for fuel, combined with external tapered pipe thread NPTF.
Filetage serré cylindrique, couplé avec filetage extérieur conique NPTF.
Zylindrisches Rohrdichtgewinde, gepaart mit kegeligem Außengewinde NPTF
Rosca gas hermética cilíndrica, combinada con rosca exterior cónica NPTF.

Confezione: Singola

Box: Single

Colis: Unique

€ Pag. listino - Price list - Liste des prix
97
97

● Standard

 ○ Disponibilità da richiedere, prezzo a listino
On enquiry, standard price-list / Stock à vérifier

 ★ Solo a richiesta
Only on request / Sur demande



Rc-NPT-NPTF



N

USO GENERALE

General purpose - Usage Général

MASCHI A MACCHINA

MACHINE TAPS - TARAUDS MACHINE

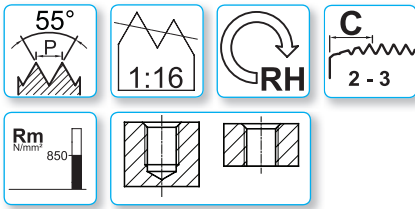
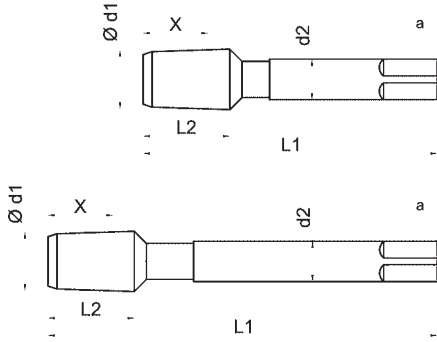

LINE

LINE

LINE

LINE



R15°



Profond. di filettatura - Thread depth - Profond. de filetage

Materiale - Material - Matériau

Tolleranza - Tolerance - Tolérance

Trattamento superficiale - Surface treatment - Revêtement

Numero gruppi materiali

Material's groups number

Nombre de groupes du matériau

-	-	-	-
HSSE	HSSE	HSSE	HSSE
-	-	-	-
BR	V	BR	TXC
1.1 1.2 1.3 1.4	1.1 1.2 1.3 1.4	1.1 1.2 1.3 1.4	1.1 1.2 1.3 1.4
3.3 3.4 4.2 4.3	2.1 2.2 2.3	3.3 3.4 4.2 4.3	2.1 2.2 2.3
5.3	3.1 3.2 3.3 3.4	5.3	3.1 3.2 3.3 3.4
	4.2 4.3 4.4 5.2 5.3		4.2 4.3 4.4 5.2 5.3

Ød1 Rc	P TPI	Ø mm	L ₁	L ₂	d ₂ h9	a h12	X	F*
1/8	28	9,728	63	13	7	5,5	10,1	8,20
1/4	19	13,157	63	20	11	9	15,0	11
3/8	19	16,662	70	20	12	9	15,4	14,5
1/2	14	20,955	80	26	16	12	20,4	18
3/4	14	26,441	100	28	20	16	21,7	23,5
1"	11	33,249	110	34	25	20	26	29,5
1 1/4"	11	41,910	125	36	32	24	28,3	38
1 1/2"	11	47,803	140	36	36	29	28,3	44
2"	11	59,614	160	40	45	35	32,6	55,5

Ød1 Rc	P TPI	Ø mm	L ₁	L ₂	d ₂ h9	a h12	X	F*
1/8	28	9,728	90	13	7	5,5	10,1	8,20
1/4	19	13,157	100	20	11	9	15,0	11
3/8	19	16,662	110	20	12	9	15,4	14,5
1/2	14	20,955	125	26	16	12	20,4	18
3/4	14	26,441	140	28	20	16	21,7	23,5
1"	11	33,249	160	34	25	20	26	29,5
1 1/4"	11	41,910	160	36	32	24	28,3	38
1 1/2"	11	47,803	190	36	36	29	28,3	44
2"	11	59,614	200	40	45	35	32,6	55,5

■ = Acciaio HSS / HSS Steel

Per accoppiamento a tenuta sul filetto.
Where pressure-tight joints are made on the threads.
Pour une tolérance serrée sur le filet.
Für im Gewinde dichtende Verbindungen.
Para conexiones herméticas en la rosca.

* Diametri di foratura cilindrici.
Per alesatura conica vedi tabella pag. 258
* Cylindric hole.
For conic hole see on page 258
* Diamètres de perçage cylindrique.
Pour alésage conique voir tableau page 258

Confezione: Singola Box: Single Colis: Unique	€ Pag. listino - Price list - Liste des prix	97	97	98	98
● Standard	○ Disponibilità da richiedere, prezzo a listino On enquiry, standard price-list / Stock à vérifier	○	○	★ Solo a richiesta Only on request / Sur demande	○

N

USO GENERALE

General purpose - Usage Général

MASCHI A MACCHINA

MACHINE TAPS - TARAUDS MACHINE

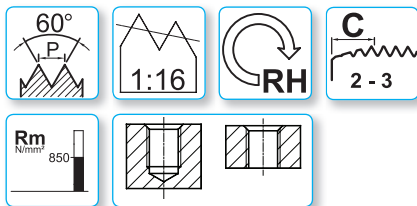
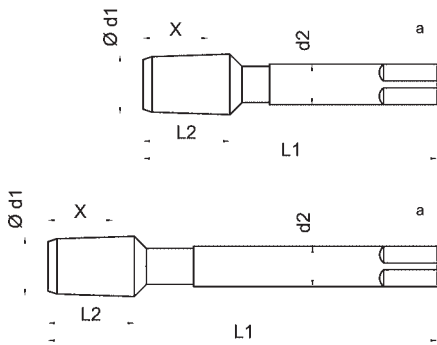

LINE

LINE

LINE

LINE



R15°



Profond. di filettatura - Thread depth - Profond. de filetage

Materiale - Material - Matériau

Tolleranza - Tolerance - Tolérance

Trattamento superficiale - Surface treatment - Revêtement

Numero gruppi materiali

Material's groups number

Nombre de groupes du matériau

-	-	-	-
HSSE	HSSE	HSSE	HSSE
-	-	-	-
BR	V	BR	TXC
1.1 1.2 1.3 1.4	1.1 1.2 1.3 1.4	1.1 1.2 1.3 1.4	1.1 1.2 1.3 1.4
3.3 3.4 4.2 4.3	2.1 2.2 2.3	3.3 3.4 4.2 4.3	2.1 2.2 2.3
5.3	3.1 3.2 3.3 3.4	5.3	3.1 3.2 3.3 3.4
	4.2 4.3 4.4 5.2 5.3		4.2 4.3 4.4 5.2 5.3

Ød1 NPT	P TPI	Ø mm	L ₁	L ₂	d ₂ h9	a h12	X	F*
1/16	27	7,938	63	13	6	4,9	9,3	6,2
1/8	27	10,287	63	13	7	5,5	9,3	8,5
1/4	18	13,716	63	20	11	9	13,5	11
3/8	18	17,145	70	20	12	9	13,9	14,5
1/2	14	21,336	80	26	16	12	18,1	17,9
3/4	14	26,670	100	26	20	16	18,6	23,2
1"	11,5	33,401	110	32	25	20	22,3	29
1 1/4"	11,5	42,164	125	32	32	24	22,8	37,8
1 1/2"	11,5	48,260	140	32	36	29	22,8	44
2"	11,5	60,325	160	36	45	35	23,2	56

CODICE - CODE	
E21CNPT...	E41CNPT...V
○	○
○	○
○	○
○	○
○	○
○	○
○	○
○	○
○	○
○	○

Ød1 NPT	P TPI	Ø mm	L ₁	L ₂	d ₂ h9	a h12	X	F*
1/16	27	7,938	90	13	6	4,9	9,3	6,2
1/8	27	10,287	90	13	7	5,5	9,3	8,5
1/4	18	13,716	100	20	11	9	13,5	11
3/8	18	17,145	110	20	12	9	13,9	14,5
1/2	14	21,336	125	26	16	12	18,1	17,9
3/4	14	26,670	140	26	20	16	18,6	23,2
1"	11,5	33,401	160	32	25	20	22,3	29
1 1/4"	11,5	42,164	160	32	32	24	22,8	37,8
1 1/2"	11,5	48,260	190	32	36	29	22,8	44
2"	11,5	60,325	200	36	45	35	23,2	56

CODICE - CODE	
E21LNPT...	E21LNPT...TXC
○	○
○	○
○	○
○	○
○	○
○	○
○	○
○	○
○	○
○	○

* Diametri di foratura cilindrici.
Per alesatura conica vedi tabella pag. 258

* Cilyndric hole.
For conic hole see on page 258

* Diamètres de perçage cylindrique.
Pour alésage conique voir tableau page 258

■ = Acciaio HSS / HSS Steel / Acier HSS

Confezione: Singola
Box: Single
Collis: Unique

€ Pag. listino - Price list - Liste des prix

98

98

98

98

● Standard

○ Disponibilità da richiedere, prezzo a listino
On enquiry, standard price-list / Stock à vérifier

★ Solo a richiesta
Only on request / Sur demande

N **USO GENERALE**
 General purpose - Usage Général

MASCHI A MACCHINA
 MACHINE TAPS - TARAUDS MACHINE

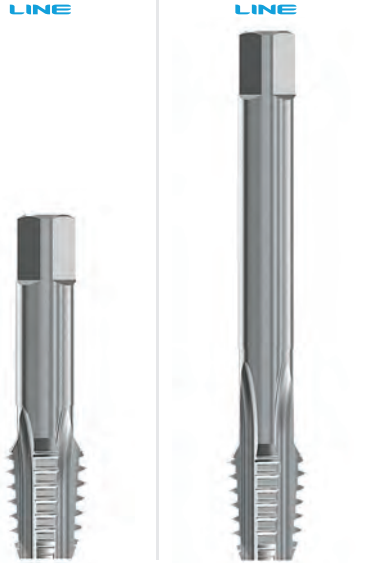
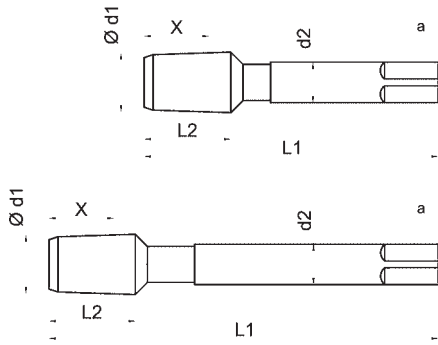

60°
 1:16
 RH
 C
 2-3
 Rm
 850
 AZ

Profond. di filettatura - Thread depth - Profond. de filetage
 Materiale - Material - Matériau
 Tolleranza - Tolerance - Tolérance
 Trattamento superficiale - Surface treatment - Revêtement
 Numero gruppi materiali
 Material's groups number
 Nombre de groupes du matériau

-	-
HSSE	HSSE
-	-
BR	BR
1.1	1.1
2.1 2.2	2.1 2.2
4.1 4.2 5.1 5.2	4.1 4.2 5.1 5.2

Ød1 NPT	P TPI	Ø mm	L ₁	L ₂	d ₂ h ₉	a h ₁₂	X	F*
1/16	27	7,938	63	13	6	4,9	9,3	6,2
1/8	27	10,287	63	13	7	5,5	9,3	8,5
1/4	18	13,716	63	20	11	9	13,5	11
3/8	18	17,145	70	20	12	9	13,9	14,5
1/2	14	21,336	80	26	16	12	18,1	17,9
3/4	14	26,670	100	26	20	16	18,6	23,2
1"	11,5	33,401	110	32	25	20	22,3	29
1 1/4"	11,5	42,164	125	32	32	24	22,8	37,8
1 1/2"	11,5	48,260	140	32	36	29	22,8	44
2"	11,5	60,325	160	36	45	35	23,2	56

E21CNPT...AZ	CODICE - CODE		
○			
○			
○			
○			
○			
○			
○			
○			
○			

Ød1 NPT	P TPI	Ø mm	L ₁	L ₂	d ₂ h ₉	a h ₁₂	X	F*
1/16	27	7,938	90	13	6	4,9	9,3	6,2
1/8	27	10,287	90	13	7	5,5	9,3	8,5
1/4	18	13,716	100	20	11	9	13,5	11
3/8	18	17,145	110	20	12	9	13,9	14,5
1/2	14	21,336	125	26	16	12	18,1	17,9
3/4	14	26,670	140	26	20	16	18,6	23,2
1"	11,5	33,401	160	32	25	20	22,3	29
1 1/4"	11,5	42,164	160	32	32	24	22,8	37,8
1 1/2"	11,5	48,260	190	32	36	29	22,8	44
2"	11,5	60,325	200	36	45	35	23,2	56

E21LNPT...AZ	CODICE - CODE		
*			
○			
○			
○			
○			
○			
○			
○			
○			

■ = Acciaio HSS / HSS Steel / Acier HSS

* Diametri di foratura cilindrici.
 Per alesatura conica vedi tabella pag. 258
 * Cylindric hole.
 For conic hole see on page 258
 * Diamètres de perçage cylindrique.
 Pour alésage conique voir tableau page 258

Confezione: Singola Box: Single Colis: Unique	€ Pag. listino - Price list - Liste des prix	98	99
● Standard	○ Disponibilità da richiedere, prezzo a listino On enquiry, standard price-list / Stock à vérifier		★ Solo a richiesta Only on request / Sur demande

N

USO GENERALE

General purpose - Usage Général

MASCHI A MACCHINA

MACHINE TAPS - TARAUDS MACHINE

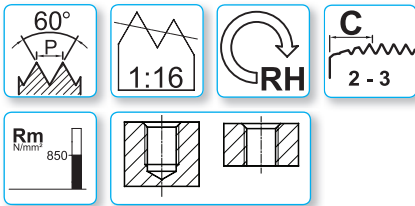
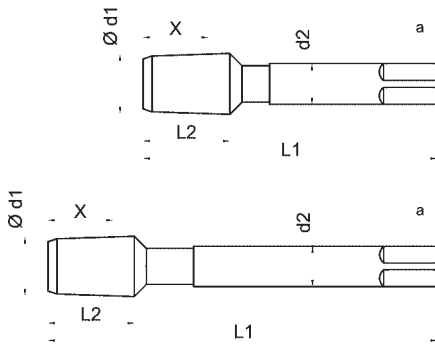

LINE

LINE

LINE

LINE



R15°



Profond. di filettatura - Thread depth - Profond. de filetage

Materiale - Material - Matériau

Tolleranza - Tolerance - Tolérance

Trattamento superficiale - Surface treatment - Revêtement

Numero gruppi materiali

Material's groups number

Nombre de groupes du matériau

-	-	-	-
HSSE	HSSE	HSSE	HSSE
-	-	-	-
BR	V	BR	TXC
1.1 1.2 1.3 1.4	1.1 1.2 1.3 1.4	1.1 1.2 1.3 1.4	1.1 1.2 1.3 1.4
3.3 3.4 4.2 4.3	2.1 2.2 2.3	3.3 3.4 4.2 4.3	2.1 2.2 2.3
5.3	3.1 3.2 3.3 3.4	5.3	3.1 3.2 3.3 3.4
	4.2 4.3 4.4 5.2 5.3		4.2 4.3 4.4 5.2 5.3

NPTF

Ød1 NPTF	P TPI	Ø mm	L ₁	L ₂	d ₂ h9	a h12	X	F*
1/16	27	7,938	63	13	6	4,9	9,3	6,1
1/8	27	10,287	63	13	7	5,5	9,3	8,45
1/4	18	13,716	63	20	11	9	13,5	10,9
3/8	18	17,145	70	20	12	9	13,9	14,3
1/2	14	21,336	80	26	16	12	18,1	17,6
3/4	14	26,670	100	26	20	16	18,6	23,0
1"	11,5	33,401	110	32	25	20	22,3	28,75
1 1/4"	11,5	42,164	125	32	32	24	22,8	37,5
1 1/2"	11,5	48,260	140	32	36	29	22,8	43,75
2"	11,5	60,325	160	36	45	35	23,2	55,75

Ød1 NPTF	P TPI	Ø mm	L ₁	L ₂	d ₂ h9	a h12	X	F*
1/16	27	7,938	90	13	6	4,9	9,3	6,1
1/8	27	10,287	90	13	7	5,5	9,3	8,45
1/4	18	13,716	100	20	11	9	13,5	10,9
3/8	18	17,145	110	20	12	9	13,9	14,3
1/2	14	21,336	125	26	16	12	18,1	17,6
3/4	14	26,670	140	26	20	16	18,6	23,0
1"	11,5	33,401	160	32	25	20	22,3	28,75
1 1/4"	11,5	42,164	160	32	32	24	22,8	37,5
1 1/2"	11,5	48,260	190	32	36	29	22,8	43,75
2"	11,5	60,325	200	36	45	35	23,2	55,75

■ = Acciaio HSS / HSS Steel / Acier HSS

CODICE - CODE	
E21CNPTF...	E41CNPTF...V
*	*
○	○
○	○
○	○
○	○
○	○
○	○
○	○
○	○
○	○

CODICE - CODE	
E21LNPTF...	E21LNPTF...TXC
*	*
○	○
○	○
○	○
○	○
○	○
○	○
*	*
*	*
*	*

* Diametri di foratura cilindrici.
Per alesatura conica vedi tabella pag. 258

* Cylindric hole.
For conic hole see on page 258

* Diamètres de perçage cylindrique.
Pour alésage conique voir tableau page 258

Confezione: Singola
Box: Single
Collis: Unique

€ Pag. listino - Price list - Liste des prix

99

99

99

99

● Standard

○ Disponibilità da richiedere, prezzo a listino
On enquiry, standard price-list / Stock à vérifier

★ Solo a richiesta
Only on request / Sur demande



BSW-PG-Tr-Rd



N **USO GENERALE**
General purpose - Usage Général

MASCHI A MACCHINA
MACHINE TAPS - TARAUDS MACHINE

DIN 371

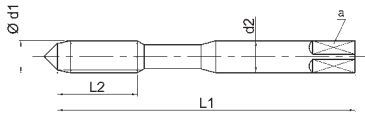

DIN 376

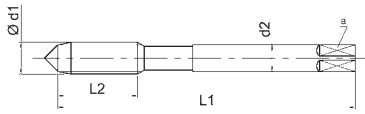

DIN 376

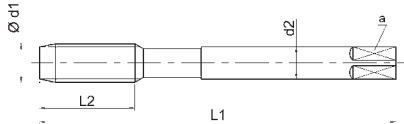

LINE



LINE

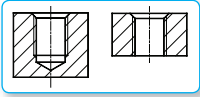

Profond. di filettatura - Thread depth - Profond. de filetage

Materiale - Material - Matériau

Tolleranza - Tolerance - Tolérance

Trattamento superficiale - Surface treatment - Revêtement

Numero gruppi materiali
Material's groups number
Nombre de groupes du matériau

1,5xD	1,5xD
HSSE	HSSE
med.	med.
BR	TiN
1.1 1.2 1.3 1.4 3.4	1.1 1.2 1.3 1.4 3.4
4.2 4.3 5.2 5.3	4.2 4.3 5.2 5.3
8.2	8.2

DIN 371	$\varnothing d_1$ BSW	P TPI	\varnothing mm	L_1	L_2	d_2 h9	a h12	Z	
◀	1/8	40	3,175	56	10	3,5	2,7	3	2,5
◀	3/16	24	4,762	70	13	6	4,9	3	3,6
◀	1/4	20	6,350	80	16	7	5,5	3	5
◀	5/16	18	7,938	90	18	8	6,2	3	6,5
◀	3/8	16	9,525	100	20	10	8	3	7,9

CODICE - CODE	
E20W...	E20W...T
○	○
○	○
○	○
○	○
○	○

DIN 376	$\varnothing d_1$ BSW	P TPI	\varnothing mm	L_1	L_2	d_2 h9	a h12	Z	
◀	5/16	18	7,938	90	18	6	4,9	3	6,5
◀	3/8	16	9,525	100	20	7	5,5	3	7,9
	7/16	14	11,113	100	20	8	6,2	3	9,2
	1/2	12	12,700	110	25	9	7	3	10,5
	9/16	12	14,288	110	28	11	9	3	12
	5/8	11	15,876	110	28	12	9	3	13,4
	3/4	10	19,051	125	32	14	11	4	16,4
	7/8	9	22,226	140	32	18	14,5	4	19,25
	1"	8	25,401	160	36	18	14,5	4	22
	1"1/8	7	28,576	180	46	22	18	4	24,75
	1"1/4	7	31,751	180	46	22	18	4	27,5
	1"3/8	6	34,926	200	50	28	22	4	30,5
	1"1/2	6	38,101	200	50	28	22	4	33,5

CODICE - CODE	
E21W...	E21W...T
○	○
○	○
○	○
○	○
○	○
○	○
○	○
○	○
○	○
○	○
○	○
○	○

Confezione / Box / Colis: 1/8 - 7/16: 10 pezzi / pcs
1/2 - 5/8: 5 pezzi / pcs
>5/8: singoli / single pcs

€ Pag. listino - Price list - Liste des prix **101** **101**

● Standard ○ Disponibilità da richiedere, prezzo a listino
On enquiry, standard price-list / Stock à vérifier

★ Solo a richiesta
Only on request / Sur demande

N

USO GENERALE

General purpose - Usage Général

MASCHI A MACCHINA

MACHINE TAPS - TARAUDS MACHINE

DIN 371

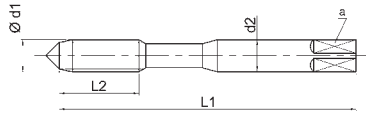

DIN 376

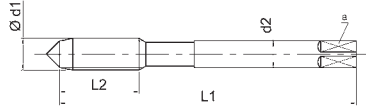

DIN 376

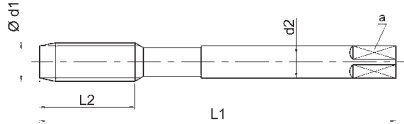

LINE



LINE



LINE



LINE



Profond. di filettatura - Thread depth - Profond. de filetage

Materiale - Material - Matériau

Tolleranza - Tolerance - Tolérance

Trattamento superficiale - Surface treatment - Revêtement

Numero gruppi materiali

Material's groups number

Nombre de groupes du matériau

3xD	3xD	3xD	3xD
HSSE	HSSE	HSSE	HSSE
med.	med.	med.	med.
BR	V	TiN	XP
1.1 1.2 1.3 1.4	1.1 1.2 1.3 1.4	1.1 1.2 1.3 1.4	1.1 1.2 1.3 1.4
4.1 4.2	4.1 4.2	3.3 3.4	2.1 2.2 3.3 3.4
5.1 5.2	5.1 5.2	4.1 4.2 4.3	4.2 4.3
	6.1 7.1	5.1 5.2	5.2

DIN 371	$\varnothing d1$ BSW	P TPI	\varnothing mm	L_1	L_2	d_2 h9	a h12	Z	
◀	1/8	40	3,175	56	10	3,5	2,7	3	2,5
◀	3/16	24	4,762	70	13	6	4,9	3	3,6
◀	1/4	20	6,350	80	16	7	5,5	3	5
◀	5/16	18	7,938	90	18	8	6,2	3	6,5
◀	3/8	16	9,525	100	20	10	8	3	7,9

CODICE - CODE			
E24W...	E24W...V	E24W...T	E24W...XP
○	○	○	○
○	○	○	○
○	○	○	○
○	○	○	○
○	○	○	○

DIN 376	$\varnothing d1$ BSW	P TPI	\varnothing mm	L_1	L_2	d_2 h9	a h12	Z	
◀	5/16	18	7,938	90	18	6	4,9	3	6,5
◀	3/8	16	9,525	100	20	7	5,5	3	7,9
	7/16	14	11,113	100	20	8	6,2	3	9,2
	1/2	12	12,700	110	25	9	7	3	10,5
	9/16	12	14,288	110	28	11	9	3	12
	5/8	11	15,876	110	28	12	9	3	13,4
	3/4	10	19,051	125	32	14	11	4	16,4
	7/8	9	22,226	140	32	18	14,5	4	19,25
	1"	8	25,401	160	36	18	14,5	4	22
	1"1/8	7	28,576	180	46	22	18	4	24,75
	1"1/4	7	31,751	180	46	22	18	4	27,5
	1"3/8	6	34,926	200	50	28	22	4	30,5
	1"1/2	6	38,101	200	50	28	22	4	33,5

CODICE - CODE			
E25W...	E25W...V	E25W...T	E25W...XP
○	○	○	○
○	○	○	○
○	○	○	○
○	○	○	○
○	○	○	○
○	○	○	○
○	○	○	○
○	○	○	○
○	○	○	○
○	○	○	○
○	○	○	○
○	○	○	○
○	○	○	○
○	○	○	○
○	○	○	○

Confezione / Box / Colis: 1/8 - 7/16: 10 pezzi / pcs 1/2 - 5/8: 5 pezzi / pcs >5/8: singoli / single pcs	€ Pag. listino - Price list - Liste des prix	101	101	101	102
● Standard	○ Disponibilità da richiedere, prezzo a listino On enquiry, standard price-list / Stock à vérifier			★ Solo a richiesta Only on request / Sur demande	

N **USO GENERALE**
General purpose - Usage Général

MASCHI A MACCHINA
MACHINE TAPS - TARAUDS MACHINE

DIN 371

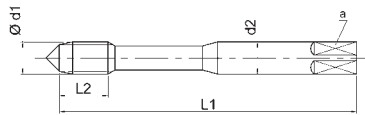

DIN 371

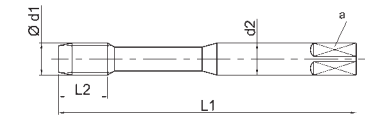

DIN 376

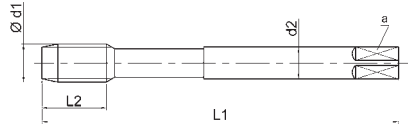

R40°



R40°



R40°



R40°

Profond. di filettatura - Thread depth - Profond. de filetage
Materiale - Material - Matériau
Tolleranza - Tolerance - Tolérance
Trattamento superficiale - Surface treatment - Revêtement

2,5xD	2,5xD	2,5xD	2,5xD
HSSE	HSSE	HSSE	HSSE
med.	med.	med.	med.
BR	V	TiN	XP
1.1 1.2 1.3 1.4	1.1 1.2 1.3 1.4	1.1 1.2 1.3 1.4	1.1 1.2 1.3 1.4
4.1 4.2	4.1 4.2	3.3 3.4	2.1 2.2 3.3 3.4
5.1 5.2	5.1 5.2	4.1 4.2 4.3	4.2 4.3
		5.1 5.2	5.2

Numero gruppi materiali
Material's groups number
Nombre de groupes du matériau

DIN 371	Ød1 BSW	P TPI	Ø mm	L1	L2	d2 h9	a h12	Z	Icon
◀	1/8	40	3,175	56	5	3,5	2,7	3	2,5
◀	3/16	24	4,762	70	8	6	4,9	3	3,6
◀	1/4	20	6,350	80	10	7	5,5	3	5
	5/16	18	7,938	90	13	8	6,2	3	6,5
	3/8	16	9,525	100	15	10	8	3	7,9

CODICE - CODE			
E60W...	E60W...V	E60W...T	E60W...XP
○	○	○	○
○	○	○	○
○	○	○	○
○	○	○	○
○	○	○	○

DIN 376	Ød1 BSW	P TPI	Ø mm	L1	L2	d2 h9	a h12	Z	Icon
	5/16	18	7,938	90	13	6	4,9	3	6,5
	3/8	16	9,525	100	15	7	5,5	3	7,9
	7/16	14	11,113	100	15	8	6,2	3	9,2
	1/2	12	12,700	110	18	9	7	3	10,5
	9/16	12	14,288	110	20	11	9	4	12
	5/8	11	15,876	110	20	12	9	4	13,4
	3/4	10	19,051	125	25	14	11	4	16,4
	7/8	9	22,226	140	25	18	14,5	4	19,25
	1"	8	25,401	160	30	18	14,5	4	22
	1" 1/8	7	28,576	180	35	22	18	4	24,75
	1" 1/4	7	31,751	180	35	22	18	4	27,5
	1" 3/8	6	34,926	200	40	28	22	4	30,5
	1" 1/2	6	38,101	200	40	28	22	4	33,5

CODICE - CODE			
E61W...	E61W...V	E61W...T	E61W...XP
○	○	○	○
○	○	○	○
○	○	○	○
○	○	○	○
○	○	○	○
○	○	○	○
○	○	○	○
○	○	○	○
○	○	○	○
○	○	○	○
○	○	○	○
○	○	○	○
○	○	○	○
○	○	○	○

Confezione / Box / Colis: 1/8 - 7/16: 10 pezzi / pcs; 1/2 - 5/8: 5 pezzi / pcs; >5/8: singoli / single pcs

€ Pag. listino - Price list - Liste des prix

● Standard

○ Disponibilità da richiedere, prezzo a listino
On enquiry, standard price-list / Stock à vérifier

★ Solo a richiesta
Only on request / Sur demande

MASCHI A MACCHINA MACHINE TAPS - TARAUDS MACHINE

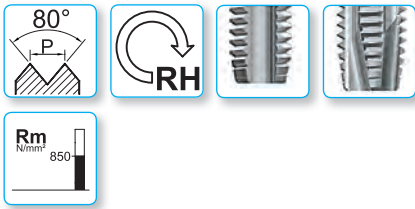
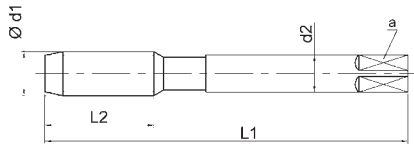
DIN 40432

Profond. di filettatura - Thread depth - Profond. de filetage

Materiale - Material - Matériau

Tolleranza - Tolerance - Tolérance

Trattamento superficiale - Surface treatment - Revêtement

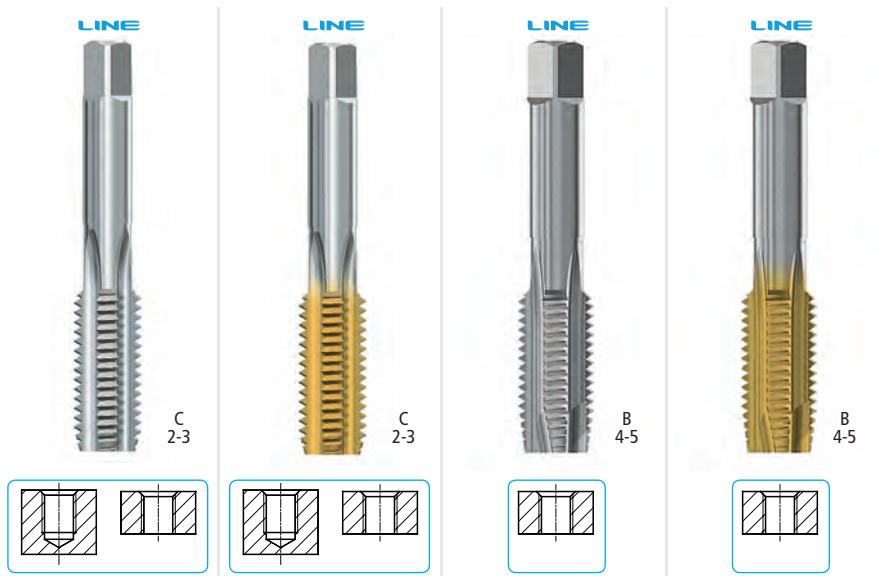
Numero gruppi materiali
 Material's groups number
 Nombre de groupes du matériau

1,5xD	1,5xD	3xD	3xD
HSSE	HSSE	HSSE	HSSE
-	-	-	-
BR	TiN	BR	TiN
1.1 1.2 1.3 1.4 3.4	1.1 1.2 1.3 1.4 3.4	1.1 1.2 1.3 1.4	1.1 1.2 1.3 1.4
4.2 4.3 5.2 5.3	4.2 4.3 5.2 5.3	4.1 4.2	3.3 3.4
8.2	8.2	5.1 5.2	4.1 4.2 4.3
			5.1 5.2

DIN 40432	Ø mm	P TPI	L ₁	L ₂	d ₂ h9	a h12	Z	
PG 7	12,5	20	70	20	9	7	3	11,4
PG 9	15,20	18	70	20	12	9	4	14
PG 11	18,60	18	80	22	14	11	4	17,25
PG 13,5	20,40	18	80	22	16	12	4	19
PG 16	22,50	18	80	22	18	14,5	4	21,25
PG 21	28,30	16	90	22	22	18	4	27
PG *21	28,30	16	90	22	20	16	4	27
PG 29	37	16	100	25	28	22	6	35,5
PG 36	47	16	140	25	36	29	6	45,5
PG *36	47	16	125	32	36	29	6	45,5
PG 42	54	16	140	28	40	32	6	52,5
PG 48	59,30	16	160	36	45	35	6	58
PG *48	59,30	16	140	32	40	32	6	58

■ = Acciaio HSS / HSS Steel / Acier HSS

 * Ad esaurimento, dimensioni secondo la vecchia edizione.
 Stock exhausted, dimensions according old edition.
 Sous réserve de disponibilité, dimensions selon l'ancienne édition.

E21PG...	CODICE - CODE		E25PG...	E25PG...T
	E21PG...T	E25PG...		
○	○	○	○	
○	○	○	○	
○	○	○	○	
○	○	○	○	
○	○	○	○	
○	○	○	○	
-	-	-	-	
○	○	○	○	
○	○	○	○	
-	-	-	-	
○	○	○	○	
○	○	○	○	
-	-	-	-	

Confezione: Singola Box: Single Colis: Unique	€ Pag. listino - Price list - Liste des prix	103	103	103	103
	● Standard	○ Disponibilità da richiedere, prezzo a listino On enquiry, standard price-list / Stock à vérifier		★ Solo a richiesta Only on request / Sur demande	

N **USO GENERALE**
 General purpose - Usage Général

MASCHI TRAPEZOIDALI SINGOLI

SINGLE TRAPEZOIDAL TAPS - TARAUDS TRAPÉZOÏDAUX INDIVIDUELS

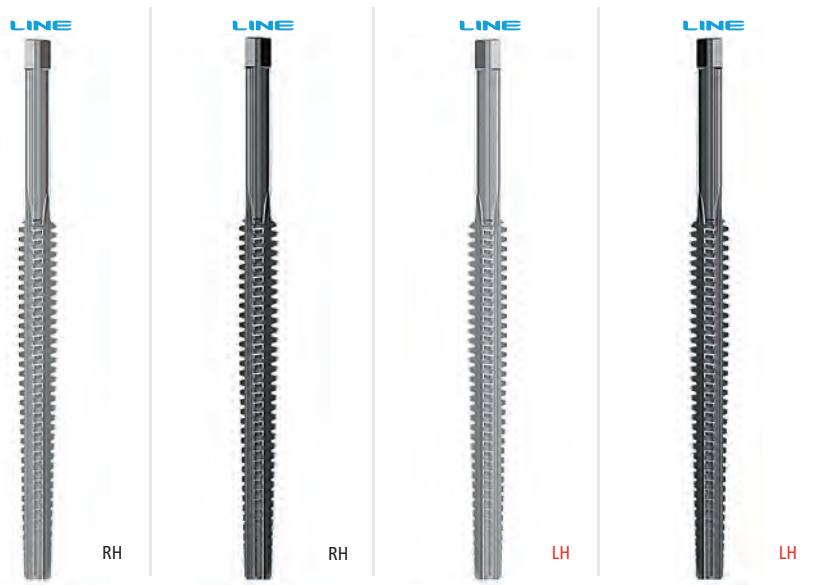
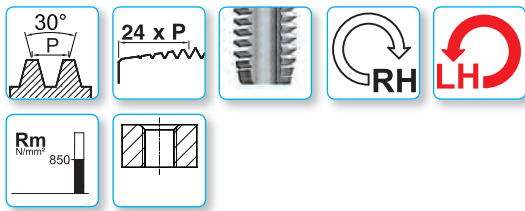
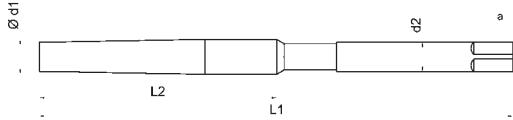

Profond. di filettatura - Thread depth - Profond. de filetage

Materiale - Material - Matériau

Tolleranza - Tolerance - Tolérance

Trattamento superficiale - Surface treatment - Revêtement

Numero gruppi materiali
 Material's groups number
 Nombre de groupes du matériau

2xD	2xD	2xD	2xD
HSSE	HSSE	HSSE	HSSE
7H	7H	7H	7H
BR	V	BR	V
1.1 1.2 1.3 1.4	1.1 1.2 1.3 1.4	1.1 1.2 1.3 1.4	1.1 1.2 1.3 1.4
3.1 3.2 3.3 3.4	3.1 3.2 3.3 3.4	3.1 3.2 3.3 3.4	3.1 3.2 3.3 3.4
4.3 4.4	4.1 4.2 4.3 4.4	4.3 4.4	4.1 4.2 4.3 4.4
5.3	5.1 5.2 5.3	5.3	5.1 5.2 5.3

Ød1 Tr	P mm	L ₁	L ₂	d ₂ h9	a ₂ h12	Z	
10	2	130	70	7	5,5	3	8,2
10	3	155	95	7	5,5	3	7,5
12	2	160	95	8	6,2	3	10,2
12	3	160	95	8	6,2	3	9,25
14	3	170	100	10	8	4	11,25
14	4	210	130	10	8	4	10,5
16	4	225	130	11	9	4	12,25
18	4	225	130	12	9	4	14,25
20	4	230	130	14	11	4	16,25
22	5	270	160	16	12	4	17,25
24	5	280	160	18	14,5	4	19,25
26	5	280	160	20	16	4	21,25
28	5	290	160	22	18	4	23,25
30	6	330	190	22	18	4	24,25
32	6	330	190	25	20	4	26,25
36	6	350	200	28	22	4	30,25

A richiesta / On request / Sur demande:
TR-F

CODICE - CODE			
E21TPN...	E21TPN...V	E21TPN...LH	E21TPN...LH-V
<input type="checkbox"/>	<input type="checkbox"/>	<input type="checkbox"/>	<input type="checkbox"/>
<input type="checkbox"/>	<input type="checkbox"/>	<input type="checkbox"/>	<input type="checkbox"/>
<input type="checkbox"/>	<input type="checkbox"/>	<input type="checkbox"/>	<input type="checkbox"/>
<input type="checkbox"/>	<input type="checkbox"/>	<input type="checkbox"/>	<input type="checkbox"/>
<input type="checkbox"/>	<input type="checkbox"/>	<input type="checkbox"/>	<input type="checkbox"/>
<input type="checkbox"/>	<input type="checkbox"/>	<input type="checkbox"/>	<input type="checkbox"/>
<input type="checkbox"/>	<input type="checkbox"/>	<input type="checkbox"/>	<input type="checkbox"/>
<input type="checkbox"/>	<input type="checkbox"/>	<input type="checkbox"/>	<input type="checkbox"/>
<input type="checkbox"/>	<input type="checkbox"/>	<input type="checkbox"/>	<input type="checkbox"/>
<input type="checkbox"/>	<input type="checkbox"/>	<input type="checkbox"/>	<input type="checkbox"/>
<input type="checkbox"/>	<input type="checkbox"/>	<input type="checkbox"/>	<input type="checkbox"/>
<input type="checkbox"/>	<input type="checkbox"/>	<input type="checkbox"/>	<input type="checkbox"/>
<input type="checkbox"/>	<input type="checkbox"/>	<input type="checkbox"/>	<input type="checkbox"/>
<input type="checkbox"/>	<input type="checkbox"/>	<input type="checkbox"/>	<input type="checkbox"/>
<input type="checkbox"/>	<input type="checkbox"/>	<input type="checkbox"/>	<input type="checkbox"/>
<input type="checkbox"/>	<input type="checkbox"/>	<input type="checkbox"/>	<input type="checkbox"/>
<input type="checkbox"/>	<input type="checkbox"/>	<input type="checkbox"/>	<input type="checkbox"/>
<input type="checkbox"/>	<input type="checkbox"/>	<input type="checkbox"/>	<input type="checkbox"/>
<input type="checkbox"/>	<input type="checkbox"/>	<input type="checkbox"/>	<input type="checkbox"/>
<input type="checkbox"/>	<input type="checkbox"/>	<input type="checkbox"/>	<input type="checkbox"/>
<input type="checkbox"/>	<input type="checkbox"/>	<input type="checkbox"/>	<input type="checkbox"/>
<input type="checkbox"/>	<input type="checkbox"/>	<input type="checkbox"/>	<input type="checkbox"/>
<input type="checkbox"/>	<input type="checkbox"/>	<input type="checkbox"/>	<input type="checkbox"/>
<input type="checkbox"/>	<input type="checkbox"/>	<input type="checkbox"/>	<input type="checkbox"/>
<input type="checkbox"/>	<input type="checkbox"/>	<input type="checkbox"/>	<input type="checkbox"/>
<input type="checkbox"/>	<input type="checkbox"/>	<input type="checkbox"/>	<input type="checkbox"/>
<input type="checkbox"/>	<input type="checkbox"/>	<input type="checkbox"/>	<input type="checkbox"/>
<input type="checkbox"/>	<input type="checkbox"/>	<input type="checkbox"/>	<input type="checkbox"/>

MASCHI A FILETTATURA TONDA

ROUND THREAD TAPS - TARAUD AVEC FILETS RONDS

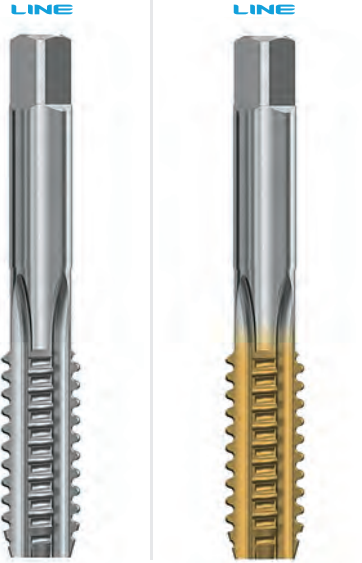
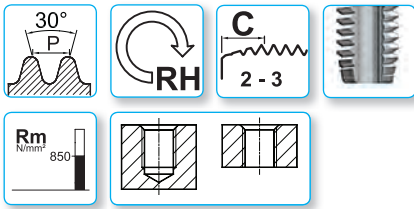
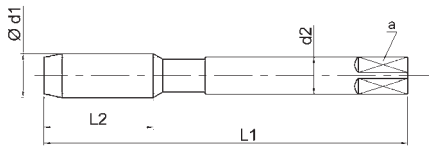

Profond. di filettatura - Thread depth - Profond. de filetage

Materiale - Material - Matériau

Tolleranza - Tolerance - Tolérance

Trattamento superficiale - Surface treatment - Revêtement

1xD

1xD

HSSE

HSSE

7H

7H

BR

TiN

Numero gruppi materiali

Material's groups number

Nombre de groupes du matériau

1.1 1.2 1.3 1.4

1.1 1.2 1.3 1.4

4.1 4.2

3.1 3.2 3.3 3.4

5.1 5.2

4.2 4.3 4.4

5.2 5.3

Ød1 Rd	P TPI	L ₁	L ₂	d ₂ h9	a ₂ h12	Z	
8	10	70	22	8	6,2	3	6
9	10	70	22	8	6,2	3	7
10	10	70	22	8	6,2	3	8
11	10	70	22	8	6,2	3	9
12	10	75	25	9	7	3	10
14	8	80	26	11	9	3	11,5
16	8	80	27	12	9	3	13,5
18	8	95	32	14	11	4	15,5
20	8	95	32	16	12	4	17,5
22	8	100	32	18	14,5	4	19,5
24	8	110	36	18	14,5	4	21,5
26	8	110	36	20	16	4	23,5
28	8	125	34	22	18	4	25,5
30	8	125	34	22	18	4	27,5

CODICE - CODE

E21RD...

E21RD...T

*

*

*

*

*

*

*

*

*

*

*

*

*

*

*

*

*

*

*

*

*

*

*

*

Altri diametri disponibili a richiesta.
Other diameters available on request.
Autres diamètres disponibles sur demande.

A richiesta:
Filettatura tonda per il settore minerario DIN 20400
Filettatura tonda per il settore del trasporto su rotaia DIN 264

On request:
Round thread for mining industries DIN 20400
Round thread for rail vehicles DIN 264

Sur demande:
Filetage rond selon DIN 20400

Confezione: Singola
Box: Single
Colis: Unique

€ Pag. listino - Price list - Liste des prix

104

104

● Standard

○ Disponibilità da richiedere, prezzo a listino
On enquiry, standard price-list / Stock à vérifier

★ Solo a richiesta
Only on request / Sur demande

ISO529-EG M-KOMBI



M

Filettatura metrica ISO passo grosso DIN 13

ISO Metric coarse thread DIN 13

Metrisches ISO-Regelgewinde DIN 13 – Maschinengewindebohrer

Filetage métrique ISO DIN 13 – Tarauds machine

Rosca ISO métrica regular DIN 13 – Machos de rosca a máquina



N

USO GENERALE

General purpose - Usage Général

MASCHI A MACCHINA

MACHINE TAPS - TARAUDS MACHINE

ISO 529

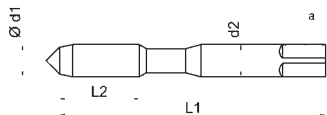

ISO 529

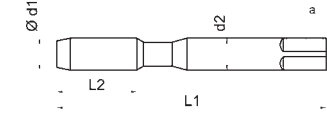

ISO 529

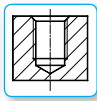
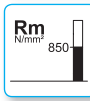
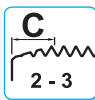
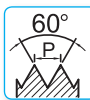
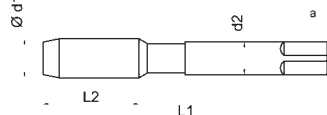

LINE



R40°

LINE



R40°

LINE



Lunghezza filetto ridotta
Thread length reduced
Longueur du filet réduite

10xP
R40°

LINE



Lunghezza filetto ridotta
Thread length reduced
Longueur du filet réduite

10xP
R40°

Profond. di filettatura - Thread depth - Profond. de filetage

Materiale - Material - Matériau

Tolleranza - Tolerance - Tolérance

Trattamento superficiale - Surface treatment - Revêtement

Numero gruppi materiali

Material's groups number

Nombre de groupes du matériau

2,5xD	2,5xD	2,5xD	2,5xD
HSSE	HSSE	HSSE	HSSE
ISO2/6H	ISO2/6H	ISO2/6H	ISO2/6H
BR	XP	BR	XP
1.1 1.2 1.3 1.4	1.1 1.2 1.3 1.4	1.1 1.2 1.3 1.4	1.1 1.2 1.3 1.4
4.1 4.2	2.1 2.2 3.3 3.4	5.1 5.2	2.1 2.2
5.1 5.2	4.2 4.3		5.2
	5.2		

ISO 529	Ød1 M	P mm	L1	L2	d2 h9	a h12	Z	
▶	3	0,5	48	11	3,15	2,5	3	2,5
▶	4	0,7	53	13	4	3,15	3	3,3
▶	5	0,8	58	16	5	4	3	4,2
▶	6	1	66	19	6,3	5	3	5
	8	1,25	72	22	8	6,3	3	6,8
	10	1,5	80	24	10	8	3	8,5
	12	1,75	89	29	9	7,1	3	10,30
	14	2	95	30	11,2	9	3	12
	16	2	102	32	12,5	10	4	14
	18	2,5	112	37	14	11,20	4	15,5
	20	2,5	112	37	14	11,20	4	17,5

ISO 529	Ød1 M	P mm	L1	L2	d2 h9	a h12	Z	
▶	3	0,5	48	5	3,15	2,5	3	2,5
▶	4	0,7	53	7	4	3,15	3	3,3
▶	5	0,8	58	8	5	4	3	4,2
▶	6	1	66	10	6,3	5	3	5
	8	1,25	72	13	8	6,3	3	6,8
	10	1,5	80	15	10	8	3	8,5
	12	1,75	89	18	9	7,1	3	10,30
	14	2	95	20	11,2	9	3	12
	16	2	102	20	12,5	10	4	14
	18	2,5	112	25	14	11,20	4	15,5
	20	2,5	112	25	14	11,20	4	17,5

★ Solo a richiesta
Only on request / Sur demande

RACCOMANDATO per filettatura rigida
We recommend Syncro rigid threading
Recommandé pour le taraudage rigide



Confezione / Box / Collis:
M3 – M10: 10 pezzi / pcs
M12 – M16: 5 pezzi / pcs

€ Pag. listino - Price list - Liste des prix

105

105

105

105

• Standard

○ Disponibilità da richiedere, prezzo a listino
On enquiry, standard price-list / Stock à vérifier

★ Solo a richiesta
Only on request / Sur demande

EG M



MASCHI A MACCHINA

MACHINE TAPS - TARAUDS MACHINE

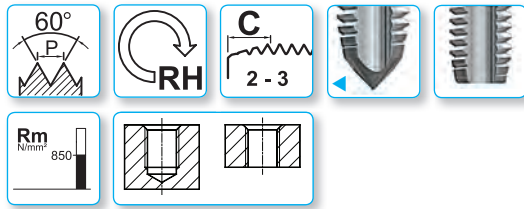
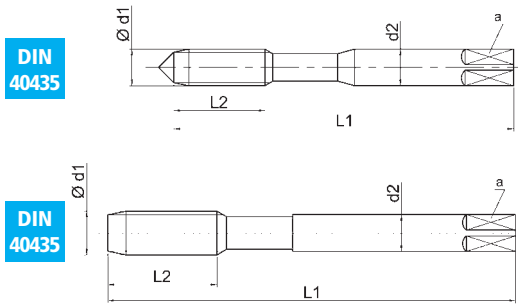

Profond. di filettatura - Thread depth - Profond. de filetage

Materiale - Material - Matériau

Tolleranza - Tolerance - Tolérance

Trattamento superficiale - Surface treatment - Revêtement

Numero gruppi materiali
 Material's groups number
 Nombre de groupes du matériau

1,5xD	1,5xD
HSSE	HSSE
6H mod	6H mod
BR	TiN
1.1 1.2 1.3 1.4 3.4	1.1 1.2 1.3 1.4 3.4
4.2 4.3 5.2 5.3	4.2 4.3 5.2 5.3
8.2	8.2

DIN	EG M	P mm	Ød1	L1	L2	d2 h9	a h12	Z	
40435	3	0,5	3,65	63	13	4,5	3,4	3	3,15
	4	0,7	4,91	70	13	6	4,9	3	4,20
	5	0,8	6,04	80	16	6	4,9	3	5,25
	6	1	7,3	90	18	8	6,2	3	6,30
	8	1,25	9,624	100	20	10	8	3	8,40

CODICE - CODE	
E20EGM...	E20EGM...T
○	○
○	○
○	○
○	○
○	○
○	○
○	○
○	○
○	○
○	○

DIN	EG M	P mm	Ød1	L1	L2	d2 h9	a h12	Z	
40435	10	1,5	11,948	100	22	9	7	3	10,5
	12	1,75	14,274	110	28	11	9	3	12,5
	14	2	16,598	110	28	12	9	3	14,5
	16	2	18,598	125	33	14	11	4	16,5
	18	2,5	21,248	140	33	18	14,5	4	18,75
	20	2,5	23,248	160	39	18	14,5	4	20,75

CODICE - CODE	
E21EGM...	E21EGM...T
○	○
○	○
○	○
○	○
○	○
★	★
★	★

N **USO GENERALE**
General purpose - Usage Général

MASCHI A MACCHINA
MACHINE TAPS - TARAUDS MACHINE

DIN 40435

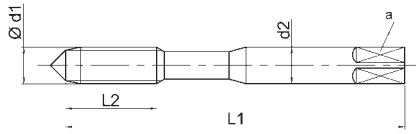

DIN 40435

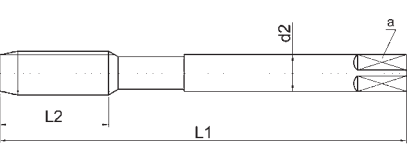

LINE



LINE

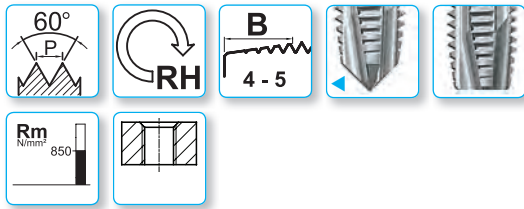

Profond. di filettatura - Thread depth - Profond. de filetage
 Materiale - Material - Matériau
 Tolleranza - Tolerance - Tolérance
 Trattamento superficiale - Surface treatment - Revêtement

Numero gruppi materiali
 Material's groups number
 Nombre de groupes du matériau

3xD	3xD
HSSE	HSSE
6H mod	6H mod
BR	XP
1.1 1.2 1.3 1.4	1.1 1.2 1.3 1.4
4.1 4.2	2.1 2.2 3.3 3.4
5.1 5.2	4.2 4.3
	5.2

DIN 40435	EG M	P mm	Ød1	L ₁	L ₂	d ₂ h9	a h12	Z	
3	0,5	3,65	63	13	4,5	3,4	3	3,15	
4	0,7	4,91	70	13	6	4,9	3	4,20	
5	0,8	6,04	80	16	6	4,9	3	5,25	
6	1	7,3	90	18	8	6,2	3	6,30	
8	1,25	9,624	100	20	10	8	3	8,40	

CODICE - CODE	
E24EGM...	E24EGM...XP
○	○
○	○
○	○
○	○
○	○

DIN 40435	EG M	P mm	Ød1	L ₁	L ₂	d ₂ h9	a h12	Z	
10	1,5	11,948	100	22	9	7	3	10,5	
12	1,75	14,274	110	28	11	9	3	12,5	
14	2	16,598	110	28	12	9	3	14,5	
16	2	18,598	125	33	14	11	4	16,5	
18	2,5	21,248	140	33	18	14,5	4	18,75	
20	2,5	23,248	160	39	18	14,5	4	20,75	

CODICE - CODE	
E25EGM...	E25EGM...XP
○	○
○	○
○	○
○	○
*	*
*	*

N

USO GENERALE
 General purpose - Usage Général

MASCHI A MACCHINA

MACHINE TAPS - TARAUDS MACHINE

DIN 40435

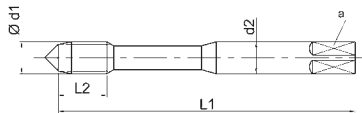

DIN 40435

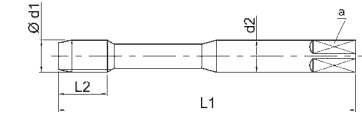

DIN 40435

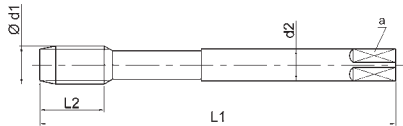

LINE



R40°

LINE



R40°

Profond. di filettatura - Thread depth - Profond. de filetage

Materiale - Material - Matériau

Tolleranza - Tolerance - Tolérance

Trattamento superficiale - Surface treatment - Revêtement

2,5xD

2,5xD

HSSE

HSSE

6H mod

6H mod

BR

XP

Numero gruppi materiali
 Material's groups number
 Nombre de groupes du matériau

1.1 1.2 1.3 1.4

1.1 1.2 1.3 1.4

4.1 4.2

2.1 2.2 3.3 3.4

5.1 5.2

4.2 4.3

5.2

DIN 40435	EGM	P mm	Ød1	L1	L2	d2 h9	a h12	Z	
3	0,5	3,65	63	7	4,5	3,4	3	3,15	
4	0,7	4,91	70	8	6	4,9	3	4,20	
5	0,8	6,04	80	10	6	4,9	3	5,25	
6	1	7,3	90	13	8	6,2	3	6,30	
8	1,25	9,624	100	15	10	8	3	8,40	

CODICE - CODE	
E60EGM...	E60EGM...XP
<input type="radio"/>	<input type="radio"/>
<input type="radio"/>	<input type="radio"/>
<input type="radio"/>	<input type="radio"/>
<input type="radio"/>	<input type="radio"/>
<input type="radio"/>	<input type="radio"/>

DIN 40435	EGM	P mm	Ød1	L1	L2	d2 h9	a h12	Z	
10	1,5	11,948	100	13	9	7	3	10,5	
12	1,75	14,274	110	20	11	9	3	12,5	
14	2	16,598	110	20	12	9	3	14,5	
16	2	18,598	125	25	14	11	4	16,5	
18	2,5	21,248	140	25	18	14,5	4	18,75	
20	2,5	23,248	160	30	18	14,5	4	20,75	

CODICE - CODE	
E61EGM...	E61EGM...XP
<input type="radio"/>	<input type="radio"/>
<input type="radio"/>	<input type="radio"/>
<input type="radio"/>	<input type="radio"/>
<input type="radio"/>	<input type="radio"/>
<input checked="" type="radio"/>	<input checked="" type="radio"/>
<input checked="" type="radio"/>	<input checked="" type="radio"/>

Confezione / Box / Colis:
 M3 – M10: 10 pezzi / pcs
 M12 – M16: 5 pezzi / pcs

€ Pag. listino - Price list - Liste des prix

106

106

• Standard

○ Disponibilità da richiedere, prezzo a listino
 On enquiry, standard price-list / Stock à vérifier

★ Solo a richiesta
 Only on request / Sur demande

KOMBI



N

USO GENERALE

General purpose - Usage Général

MASCHI A MACCHINA KOMBI

KOMBI MACHINE TAPS - TARAUDS MACHINE KOMBI

UFS norm

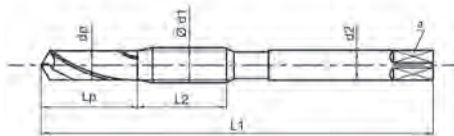

LINE



R30°

LINE



R30°

LINE



AL R30°

LINE



AL R30°

Profond. di filettatura - Thread depth - Profond. de filetage

Materiale - Material - Matériau

Tolleranza - Tolerance - Tolérance

Trattamento superficiale - Surface treatment - Revêtement

Numero gruppi materiali

Material's groups number

Nombre de groupes du matériau

1,5xD	1,5xD	1,5xD	1,5xD
HSSE	HSSE	HSSE	HSSE
ISO2/6H	ISO2/6H	ISO2/6H	ISO2/6H
BR	VS	BR	VS
1.1 1.2 1.3 1.4	1.1 1.2 1.3 1.4	4.1 4.2	4.1 4.2
4.3 4.2	3.3 3.4	5.1 5.2	5.1 5.2
5.2 5.3	4.2 4.3	8.1	8.1
	5.2 5.3		

UFS norm	M	P mm	L ₁	L ₂	d ₂ h9	a h12	L _p	d _p	Z
◀	3	0,5	66	10	3,5	2,7	10	2,5	2
◀	4	0,7	69	11	4,5	3,4	11	3,3	2
◀	5	0,8	81,5	11	6	4,9	12	4,2	2
◀	6	1	82,5	13	6	4,9	13	5	2
◀	8	1,25	101	14	6	4,9	18	6,8	4
◀	10	1,5	107	15	7	5,5	24	8,5	4
◀	12	1,75	120	17	9	7	25	10,3	4
◀	3	0,5	66	10	3,5	2,7	10	2,5	2
◀	4	0,7	69	11	4,5	3,4	11	3,3	2
◀	5	0,8	81,5	11	6	4,9	12	4,2	2
◀	6	1	82,5	13	6	4,9	13	5	2
◀	8	1,25	101	14	6	4,9	18	6,8	2
◀	10	1,5	107	15	7	5,5	24	8,5	2
◀	12	1,75	120	17	9	7	25	10,3	2

CODICE - CODE			
EPFM...	EPFM...VS	EPFALUM...	EPFALUM VS
○	○	○	○
●	○	○	○
●	○	○	○
●	○	○	○
●	○	○	○
●	○	○	○
●	○	○	○
●	○	○	○
-	-	○	○
-	-	○	○
-	-	○	○
-	-	○	○
-	-	○	○
-	-	○	○

UFS norm	MF	P mm	L ₁	L ₂	d ₂ h9	a h12	L _p	d _p	Z
◀	8	1	101	14	6	4,9	18	7	4
◀	10	1	107	15	7	5,5	24	9	4
◀	10	1,25	107	15	7	5,5	24	8,8	4
◀	12	1,5	120	17	9	7	25	10,5	4

CODICE - CODE			
EPFMF...	EPFMF...VS		
○	○		
○	○		
○	○		
○	○		

Confezione / Box / Colis:
M3 – M10: 10 pezzi / pcs
M12 – M16: 5 pezzi / pcs

€ Pag. listino - Price list - Liste des prix

107

107

107

107

● Standard

○ Disponibilità da richiedere, prezzo a listino
On enquiry, standard price-list / Stock à vérifier

★ Solo a richiesta
Only on request / Sur demande



FILIERE TONDE IMBOCCO CORRETTO

ROUND SPLIT DIES WITH SPIRAL POINTED - FILIÈRES RONDES, ENTRÉE GUN

DIN - EN 22568

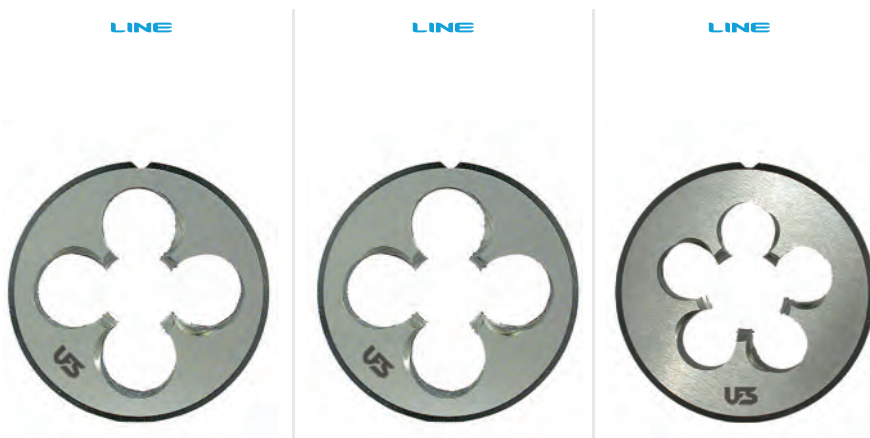
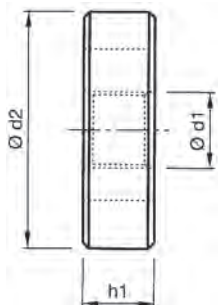

Filettatura sinistra - LH
Left hand
Filetage Gauche - LH

Inox
Stainless Steel

Materiale - Material - Matériau	HSS	HSS	HSSE
Imbocco - Chamfer - Entrée	1,75xP	1,75xP	1,75xP
Tolleranza - Tolerance - Tolérance	ISO / 6g	ISO / 6g	ISO / 6g
Trattamento superficiale - Surface treatment - Revêtement	BR	BR	BR

Ød ₁ M	P mm	Ød ₂	h ₁	100-99M...	CODICE - CODE 100S99M...	100E99XM...
2	0,4	16	5	○	-	-
2,2	0,45	16	5	○	-	-
2,3	0,4	16	5	○	-	-
2,5	0,45	16	5	○	-	-
2,6	0,45	16	5	○	-	-
3	0,5	20	5	○	○	○
3,5	0,6	20	5	○	-	-
4	0,7	20	5	○	○	○
4,5	0,75	20	7	○	-	-
5	0,8	20	7	○	○	○
6	1	20	7	○	○	○
7	1	25	9	○	○	-
8	1,25	25	9	○	○	○
9	1,25	25	9	○	○	-
10	1,5	30	11	○	○	○
11	1,5	30	11	○	○	-
12	1,75	38	14	○	○	○
14	2	38	14	○	○	○
16	2	45	18	○	○	○
18	2,5	45	18	○	○	○
20	2,5	45	18	○	○	○
22	2,5	55	22	○	○	○
24	3	55	22	○	○	○
27	3	65	25	○	○	○
30	3,5	65	25	○	○	○
33	3,5	65	25	○	○	○
36	4	65	25	○	○	○
39	4	75	30	○	○	○
42	4,5	75	30	○	○	○
45	4,5	90	36	○	○	○
48	5	90	36	○	○	○
52	5	90	36	○	○	○

Confezione: Singola
Box: Single
Colis: Unique

€ Pag. listino - Price list - Liste des prix

111

111

111

● Standard

○ Disponibilità da richiedere, prezzo a listino
On enquiry, standard price-list / Stock à vérifier

★ Solo a richiesta
Only on request / Sur demande

FILIERE TONDE IMBOCCO CORRETTO
 ROUND SPLIT DIES WITH SPIRAL POINTED - FILIÈRES RONDES, ENTRÉE GUN

DIN - EN 22568

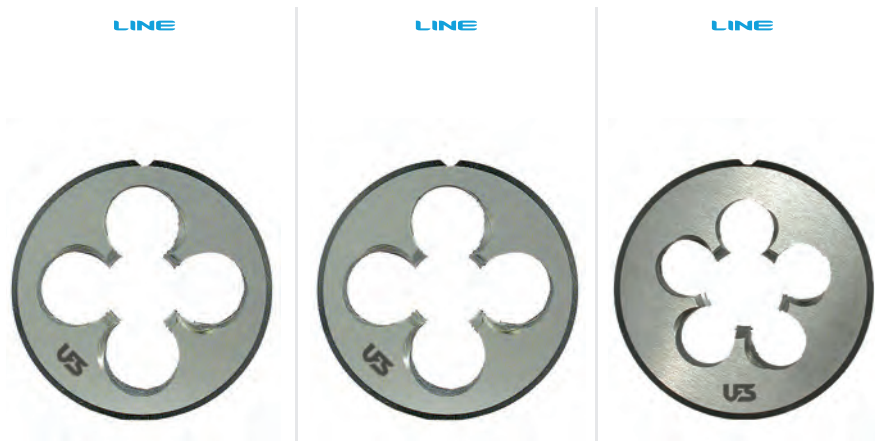
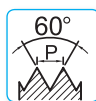
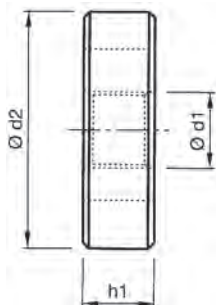

Filettatura sinistra - LH
 Left hand
 Filetage Gauche - LH

Inox
 Stainless Steel

Materiale - Material - Matériau	HSS	HSS	HSSE
Imbocco - Chamfer - Entrée	1,75xP	1,75xP	1,75xP
Tolleranza - Tolerance - Tolérance	ISO / 6g	ISO / 6g	ISO / 6g
Trattamento superficiale - Surface treatment - Revêtement	BR	BR	BR

Ød ₁ MF	P mm	Ød ₂	h ₁	CODICE - CODE		
				110-99M...	110S99M...	110E99XM...
2	0,25	16	5	○	*	-
2,2	0,25	16	5	○	*	-
2,5	0,35	16	5	○	*	-
3	0,35	20	5	○	*	*
4	0,5	20	5	○	○	○
5	0,5	20	5	○	○	○
6	0,75	20	7	○	○	○
7	0,75	25	9	○	○	*
8	0,75	25	9	○	○	*
8	1	25	9	○	○	○
9	0,75	25	9	○	○	*
9	1	25	9	○	○	*
10	0,75	30	11	○	○	○
10	1	30	11	○	○	○
10	1,25	30	11	○	○	*
11	1	30	10	○	○	*
12	1	38	10	○	○	○
12	1,25	38	10	○	○	○
12	1,5	38	10	○	○	○
13	1	38	10	○	*	*
13	1,5	38	10	○	*	*
14	1	38	10	○	○	○
14	1,25	38	10	○	○	○
14	1,5	38	10	○	○	○
15	1	38	10	○	○	*
15	1,5	38	10	○	○	*
16	1	45	14	○	○	○
16	1,25	45	14	○	○	*
16	1,5	45	14	○	○	○
18	1	45	14	○	○	○
18	1,5	45	14	○	○	○

Segue diametri
 Diameters, to be continued - Diamètres à suivre ▶ Pag. 238-239

Confezione: Singola Box: Single Colis: Unique	€ Pag. listino - Price list - Liste des prix	112	113	113
	● Standard	○ Disponibilità da richiedere, prezzo a listino On enquiry, standard price-list / Stock à vérifier		* Solo a richiesta Only on request / Sur demande

DIN - EN 22568

LINE

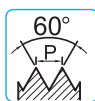
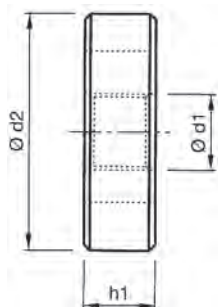

Materiale - Material - Matériau

HSS

Imbocco - Chamfer - Entrée

1,75xP

Tolleranza - Tolerance - Tolérance

ISO / 6g

Trattamento superficiale - Surface treatment - Revêtement

BR

Ød ₁ MF	P mm	Ød ₂	h ₁	CODICE - CODE	
				110-99M...	
34	1	65	18	○	
34	1,5	65	18	○	
35	1	65	18	○	
35	1,5	65	18	○	
35	2	65	18	○	
36	1,5	65	18	○	
36	2	65	18	○	
36	3	65	25	○	
38	1	75	20	○	
38	1,5	75	20	○	
38	2	75	20	○	
39	1,5	75	20	○	
39	2	75	20	○	
39	3	75	30	○	
40	1,5	75	20	○	
40	2	75	20	○	
40	3	75	30	○	
42	1,5	75	20	○	
42	2	75	20	○	
42	3	75	30	○	
45	1,5	90	22	○	
45	2	90	22	○	
45	3	90	36	○	
48	1,5	90	22	○	
48	2	90	22	○	
48	3	90	36	○	
50	1,5	90	22	○	
50	2	90	22	○	
50	3	90	36	○	
52	1,5	90	22	○	
52	2	90	22	○	
52	3	90	36	○	

Confezione: Singola
 Box: Single
 Colis: Unique

€ Pag. listino - Price list - Liste des prix

112

● Standard

○ Disponibilità da richiedere, prezzo a listino
 On enquiry, standard price-list / Stock à vérifier

★ Solo a richiesta
 Only on request / Sur demande

FILIERE TONDE IMBOCCO CORRETTO

ROUND SPLIT DIES WITH SPIRAL POINTED - FILIÈRES RONDES, ENTRÉE GUN

DIN - EN 22568

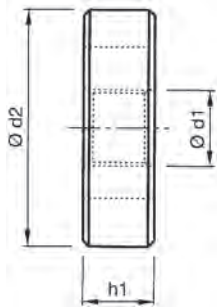

LINE

LINE



Filettatura sinistra - LH
Left hand
Filetage Gauche - LH

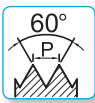

Materiale - Material - Matériau

HSS

HSS

Imbocco - Chamfer - Entrée

1,75xP

1,75xP

Tolleranza - Tolerance - Tolérance

2A

2A

Trattamento superficiale - Surface treatment - Revêtement

BR

BR

Ød ₁ UNC	TPI	Ød ₂	h ₁	300-99U...	CODICE - CODE 300S99U...
4	40	20	5	○	○
5	40	20	5	○	○
6	32	20	5	○	○
8	32	20	7	○	○
10	24	20	7	○	○
12	24	20	7	○	○
1/4	20	25	9	○	○
1/4	20	20	7	*	*
5/16	18	25	9	○	○
3/8	16	30	11	○	○
7/16	14	30	11	○	○
1/2	13	38	14	○	-
9/16	12	38	14	○	-
5/8	11	45	18	○	-
3/4	10	45	18	○	-
7/8	9	55	22	○	-
1"	8	55	22	○	-
1" 1/8	7	65	25	○	-
1" 1/4	7	65	25	○	-
1" 1/2	6	75	30	○	-
1" 3/4	5	90	36	○	-
2"	4,5	90	36	○	-

Confezione: Singola
Box: Single
Colis: Unique

€ Pag. listino - Price list - Liste des prix

114

114

● Standard

○ Disponibilità da richiedere, prezzo a listino
On enquiry, standard price-list / Stock à vérifier

★ Solo a richiesta
Only on request / Sur demande

FILIERE TONDE IMBOCCO CORRETTO

ROUND SPLIT DIES WITH SPIRAL POINTED - FILIÈRES RONDES, ENTRÉE GUN

DIN - EN 22568

LINE

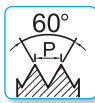
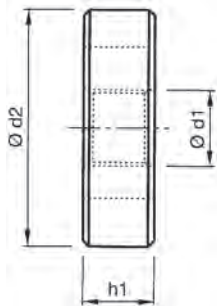

Materiale - Material - Matériau

HSS

Imbocco - Chamfer - Entrée

1,75xP

Tolleranza - Tolerance - Tolérance

-

Trattamento superficiale - Surface treatment - Revêtement

BR

Ød ₁ * NPT	TPI	Ød ₂	h ₁
1/16	27	25	10
1/8	27	38	10
1/8	27	30	10
1/4	18	38	15
3/8	18	45	15,3
1/2	14	45	20
3/4	14	65	20,2
3/4	14	55	20,2
1"	11,5	65	25
1" 1/4	11,5	75	25,6
1" 1/2	11,5	90	26
2"	11,5	105	26,9

*ANSI/ASME B1.20.1

Ød ₁ * NPTF	TPI	Ød ₂	h ₁
1/16	27	25	11
1/8	27	38	10
1/4	18	38	15
3/8	18	45	15
1/2	14	45	20
3/4	14	65	20,2
3/4	14	55	20,2
1"	11,5	65	25

*ANSI/ASME B1.20.3

420-99NPT...

CODICE - CODE

*

o

*

o

o

o

o

*

o

o

o

430-99NPTF...

CODICE - CODE

*

o

o

o

o

o

*

o

Confezione: Singola
Box: Single
Colis: Unique

€ Pag. listino - Price list - Liste des prix

115

• Standard

o Disponibilità da richiedere, prezzo a listino
On enquiry, standard price-list / Stock à vérifier

★ Solo a richiesta
Only on request / Sur demande

FILIERE TONDE IMBOCCO CORRETTO

ROUND SPLIT DIES WITH SPIRAL POINTED - FILIÈRES RONDES, ENTRÉE GUN

DIN - EN 22568

LINE

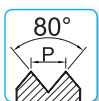
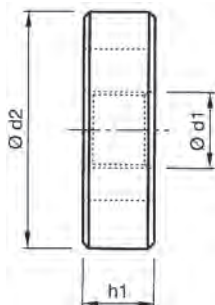

Materiale - Material - Matériau

HSS

Imbocco - Chamfer - Entrée

1,75xP

Tolleranza - Tolerance - Tolérance

-

Trattamento superficiale - Surface treatment - Revêtement

BR

Ød ₁ PG	TPI	Ød ₂	h ₁
7	20	38	14
9	18	38	14
11	18	45	14
13,5	18	45	14
16	18	55	16
21	16	65	18
29	16	65	18
36	16	90	22
42	16	105	22
48	16	105	22

CODICE - CODE

700-99PG...

○

○

○

○

○

○

○

○

★

★

Confezione: Singola
Box: Single
Colis: Unique

€ Pag. listino - Price list - Liste des prix

116

● Standard

○ Disponibilità da richiedere, prezzo a listino
On enquiry, standard price-list / Stock à vérifier

★ Solo a richiesta
Only on request / Sur demande



L'AZIENDA E I SUOI PRODOTTI

THE COMPANY AND ITS PRODUCTS - LA SOCIÉTÉ ET SES PRODUITS

Materiali impiegati - Used material - Matériaux utilisés

La resa di un utensile è determinata da un insieme di fattori, ma alla base di tutto vi è il materiale con cui è stato costruito l'utensile stesso. La UFS si avvale dei migliori acciai super rapidi ad alto contenuto di cobalto (5% ed oltre, oppure ad alta percentuale di Vanadio) e di acciai da polveri sinterizzate (PM, PM1, PM3 con alte % di Co e Co + Vanadio). Questi ultimi presentano una struttura molto più omogenea, con distribuzione finissima dei carburi, con corrispondente minor pericolo di scheggiatura, minor usura e ottime prestazioni sui materiali ad alta resistenza.

- Acciaio HSSE con 5% di Cobalto impiegato per materiali da lavorare con $R < 850 \text{ N/mm}^2$
- Acciaio HSSP con più alta percentuale di Cobalto impiegato per materiali da lavorare con $R < 1000 \text{ N/mm}^2$
- Acciaio HSSV3 con alta percentuale di Vanadio impiegato per INOX
- Acciai PM sinterizzati ad alto contenuto di Cobalto e Vanadio impiegato per materiali da lavorare con $R > 1000 \text{ N/mm}^2$

The tool yield is determined by several factors, but most fundamental is the material. UFS uses the best high speed steels of high cobalt content (5% and over, or a high percentage of vanadium) and steels made from sintered powders (PM, PM1, PM3 high % of Co and Co + Va). This materials show a more homogeneous structure, with low carbide content, and with a correspondingly reduced risk of splintering, less wear and better performance on materials of high resistance.

- HSSE steel with 5% of Cobalt used for materials to work with $R < 850 \text{ N/mm}^2$
- HSSP steels with higher Cobalt percentage (or vanadium) used for materials to work with $R < 1000 \text{ N/mm}^2$
- HSSV3 steel with high percentage of Vanadium, for InOX
- Sintered PM steels of a high cobalt and vanadium content used for materials to work with $R > 1000 \text{ N/mm}^2$

La performance d'un outil est déterminée par un certain nombre de facteurs, mais derrière tout cela il y a le matériau avec lequel il a été fabriqué. La société UFS fait usage des meilleurs aciers super rapide riches en cobalt (5 % et plus, ou avec un pourcentage élevé de vanadium) également des aciers frittés (PM, PM1, PM3 élevé en % de Co et Co + vanadium). Ces derniers ont une structure beaucoup plus homogène avec une concentration très fine de carbures, ce qui diminue considérablement les risques d'écaillage, diminue l'usure et acquièrent d'excellentes performances sur des matériaux de haute résistance.

- Acier HSSE avec 5 % de cobalt pour les matériaux avec une résistance $R < 850 \text{ N/mm}^2$
- Acier HSSP avec pourcentage plus élevé de Cobalt utilisé pour les matériaux avec une résistance $R < 1000 \text{ N/mm}^2$
- HSSV3 acier avec un pourcentage de Vanadium utilisé pour l'acier inoxydable
- Aciers frittés PM avec un fort pourcentage de Cobalt Vanadium utilisés pour les matériaux avec une résistance $R > 1000 \text{ N/mm}^2$



Trattamenti termici - Heat Treatments - Traitements thermiques

Il trattamento termico è un fattore determinante per la resa dell'utensile e consiste in: **preriscaldi - tempra - rinvenimenti**. I preriscaldi sono gradualmente e la tempra è assistita da accuratissimi controlli della temperatura e dei tempi di austenitizzazione. Seguono 4-5 rinvenimenti per la trasformazione completa della struttura. Il controllo del grano austenitico avviene dopo l'austenitizzazione ed il controllo della durezza e della struttura dopo i rinvenimenti. Il trattamento termico viene eseguito in forni "sottovuoto" che garantiscono una tempra di alta qualità.

*Heat treatment is a conclusive factor for the yield of the tool and consists of **preheating - hardening - tempering**. The preheating is gradual and the tempering is assisted by very accurate controls of the temperature and the times of austenitisation. Then 4-5 recoveries follow for the complete transformation of the structure. The check of the austenitic grain occurs after the austenitisation and the hardness and the structure check after tempering. Heat treatment are performed in vacuum ovens, which guarantee high quality tempering.*

*Le traitement thermique est un facteur déterminant pour la performance de l'outil et se compose de: **Préchauffe-trempe-revenu**. Le préchauffage est progressif et le durcissement est secondé par des contrôles précis de la température. Suivent 4-5 revenus pour la transformation de la structure. Le Traitement thermique est effectué dans des fours sous « vide » de dernière génération qui garantissent une haute qualité.*

Qualità dei prodotti - Products quality - Qualité des produits

I nostri controlli si basano da sempre su analisi metallografiche e dimensionali. Con la nuova realtà definita UFS Technology il prodotto, a campione, viene sottoposto a test di durata e a miglioramenti, specie per prodotti studiati su materiali particolari, a richiesta della Clientela. Il personale dedicato lavora a tempo pieno sia sull'avanzamento prodotto UFS sia nella definizione delle nuove forme di utensili adatti a materiali nuovi o di dichiarato interesse in Progetti di Ricerca Europei, in collaborazione con il Politecnico di Torino - Facoltà di Scienza dei Materiali - e di altre simili ed importanti Facoltà Europee, tra cui Aachen e Bilbao. Questo ci dà modo di sperimentare materiali di indubbia difficoltà, come le leghe ceramiche, ghise particolari, leghe aeronautiche e spaziali, per citarne alcune; i processi migliorativi definiti su tali materiali ci aiutano ad innalzare il livello qualitativo della normale produzione standard.

Our checks have always been based on metallographic and dimensional tests. Thanks to the new UFS Technology, the sample product subjected is tested for durability and improved, especially with products designed using special materials at the customer's request. The staff appointed to these operations work full time both in UFS product improvement and in defining new tool shapes suitable for new materials or materials required for European Research Projects, together with Polytechnic University of Turin, Faculty of Materials Science as well as other important European Universities, including Aachen and Bilbao. This allows us to test undoubtedly difficult materials, like ceramic alloys, special cast iron, aeronautical and space alloys, among others; the improvement processes established for these materials help us to raise the quality level of the standard production.

Nos contrôles s'appuient toujours sur l'analyse métallographique et dimensionnelle. Avec la nouvelle structure D'UFS Technology le produit est testé pour une durabilité optimale. Le personnel travaille à plein temps sur des projets de recherche européens, en collaboration avec l'Université de Turin- la Faculté Polytechnique de science des matériaux- et d'autres institutions européennes importantes, dont Aachen et Bilbao. Cela nous donne une façon d'expérimenter des difficultés incontestables, des matériaux tels que céramiques, alliages, alliages de fer et alliages spéciaux pour l'aviation et l'espace.

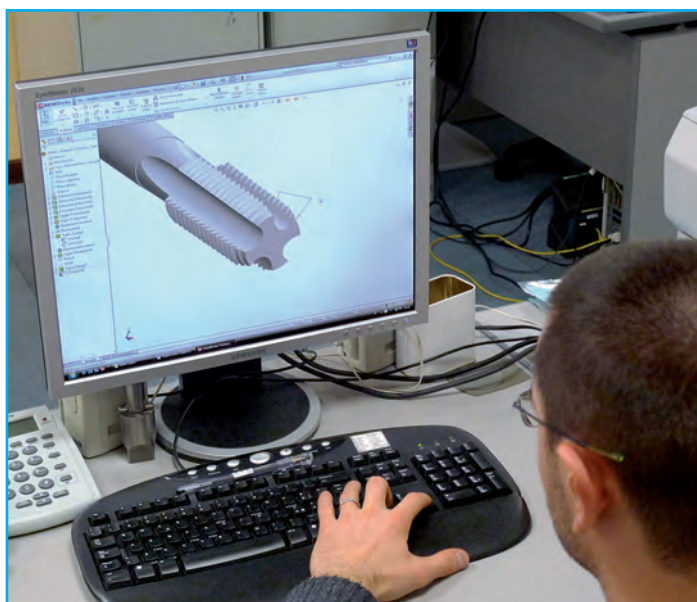

Obiettivi - Purposes - Objectifs

Gli obiettivi definiti nel precedente catalogo sono stati ampiamente raggiunti e nel corso di questi ultimi anni i processi di produzione stabilizzati ci hanno dato modo di innalzare la qualità e la ripetibilità del prodotto.

Non ci resta che confermare la rotta nella stessa direzione di miglioramento continuo, con la caparbietà che ci accompagna.

The aims set out in our previous catalogue have been widely achieved and during these last few years the consolidated production processes have allowed us to increase product quality and repeatability. We only have to continue in this quest for continuous improvement, with our characteristic determination.

Les objectifs définis dans la liste précédente ont été largement atteints, et ces dernières années, les procédés de production stabilisés nous ont permis d'améliorer la qualité et la reproductibilité des outils.

TERMINOLOGIA DEI MASCHI

TAPS TERMINOLOGY - TERMINOLOGIE DES TARAUDS

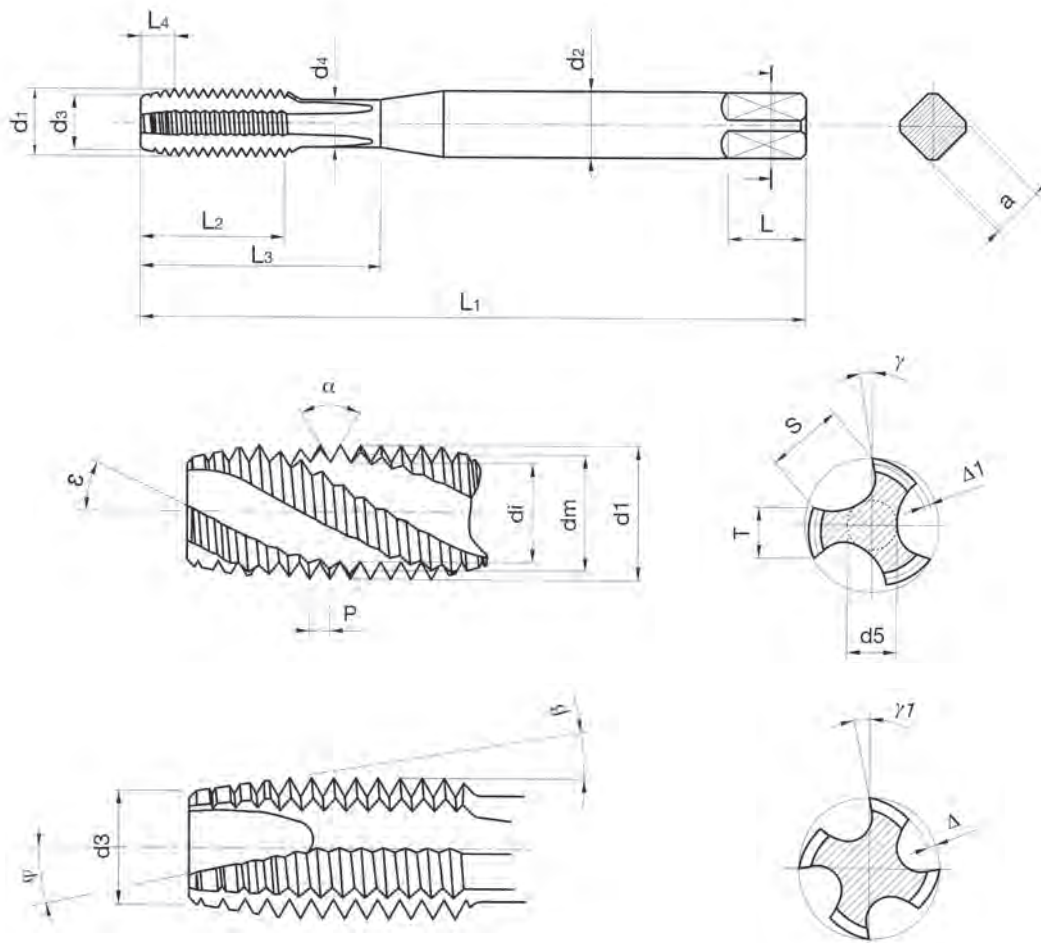

LEGENDA

LEGENDE - LÉGENDE

- L1:** Lunghezza totale – Total length - Longueur totale
- L2:** Lunghezza filetto – Thread length - Longueur du filet
- L4:** Lunghezza imbocco – Chamfer length - Longueur de l'entrée
- L3:** Lunghezza utile – Useful length - Longueur utile
- L:** Lunghezza quadro – Length of square - Longueur du cadre
- P:** Passo – Pitch - Pas
- S:** Larghezza scanalatura – Flute width - Largeur de la goujure
- d1:** Diametro est. nominale – Major diameter - Diamètre extérieur nominal
- d2:** Diametro del gambo – Shank diameter - Diamètre de queue
- d4:** Diametro del collarino – Neck diameter - Diamètre du cou
- d3:** Diametro di imbocco – Chamfer diameter - Diamètre de l'entrée
- dm:** Diametro medio – Pitch diameter - Diamètre moyen

- di:** Diametro interno – Minor diameter - Diamètre intérieur
- d5:** Diametro nucleo – Core diameter - Diamètre du noyau
- T:** Larghezza del dente – Width of land - Largeur de la dent
- α:** Angolo del profilo – Included angle of thread - Angle du profil
- γ1:** Angolo di taglio frontale – Rake angle - Angle de coupe avant
- γ:** Angolo di taglio sull'imbocco corretto – Rake angle of spiral point - Angle de coupe sur l'entrée
- β:** Angolo di imbocco – Chamfer angle - Angle de l'entrée
- ε:** Inclinazione dell'elica – Spiral flute angle - Angle d'hélice
- Δ:** Spoglia sull'imbocco – Chamfer relief - Dépouille de l'entrée
- Δ1:** Spoglia sul filetto – Pitch diameter relief - Dépouille sur le filet
- a:** Quadro – Square - Carré
- φ:** Angolo inclinazione imbocco corretto – Spiral point angle - Angle d'inclinaison de l'entrée GUN

TERMINOLOGIA FILIERE





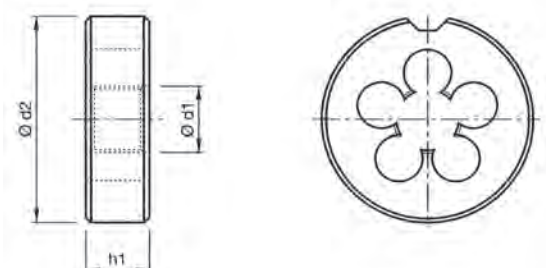





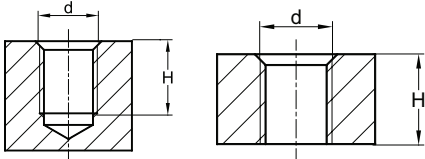

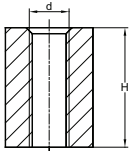
DIES TERMINOLOGY - TERMINOLOGIE FILIERE

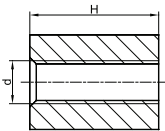
- d1:** Diametro nominale – Nominal diameter - Diamètre nominal
- d2:** Diametro esterno – External diameter - Diamètre extérieur
- h1:** Spessore – Thickness - Épaisseur

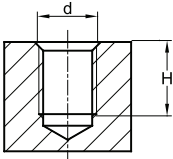

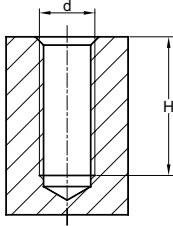
TIPI DI FORO E RELATIVI MASCHI CONSIGLIATI

HOLE TYPES AND RECOMMENDED TAPS - TYPES DE TROU ET TARAUDS RECOMMANDÉS

Fori ciechi e passanti <i>Blind and through holes - Trous borgnes et débouchant</i>				
	$H < 1,5 d$	E20		
Fori passanti <i>Through holes - Trous débouchant</i>				
	$H < 3 d$	E24		
	$H < 3 d$	E50		
Fori ciechi <i>Blind holes - Trous borgnes</i>				
	$H < 1,5 d$	E40		
	$H < 2,5 d$	E60		
	$H 2,5 \div 3 d$	E80	 BT = Back Tapered Rastremazione posteriore del filetto Détalonnage arrière	
	$H > 3 d$	E82		

TIPI DI IMBOCCO

CHAMFER TYPE - TYPES D'ENTRÉES

Lunghezza
Length - Longueur
n° x P

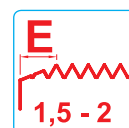
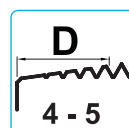
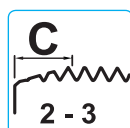
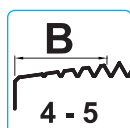
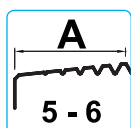

PREFORI DI MASCHIATURA PER MASCHI AD ASPORTAZIONE

TAPPING DRILL SIZES FOR CUTTING TAPS

PERÇAGE POUR TARAUDAGE NORMAL

Filettatura metrica ISO DIN 13

ISO Metric coarse thread DIN 13 - Filetage métrique ISO DIN13

M	P mm		Ø di foratura 6H - drill sizes - perçage	
			min	max
*M 1	0,25	0,75	0,729	0,785
*M 1,1	0,25	0,85	0,829	0,885
*M 1,2	0,25	0,95	0,929	0,985
*M 1,4	0,30	1,10	1,075	1,142
M 1, 6	0,35	1,25	1,221	1,321
M 1,70	,35	1,35	1,321	1,421
M 1,8	0,35	1,45	1,421	1,521
M 2	0,40	1,60	1,567	1,679
M 2,2	0,45	1,75	1,713	1,838
M 2,3	0,4	1,90	1,813	1,938
M 2,5	0,45	2,05	2,013	2,138
M 2,6	0,45	2,10	2,113	2,238
M 3	0,50	2,50	2,459	2,599
M 3,5	0,60	2,90	2,850	3,010
M 4	0,70	3,30	3,242	3,422
M 4, 5	0,75	3,70	3,688	3,878
M 5	0,80	4,20	4,134	4,334
M 6	1,00	5,00	4,917	5,153
M 7	1,00	6,00	5,917	6,153
M 8	1,25	6,80	6,647	6,912
M 9	1,25	7,80	7,647	7,912
M 10	1,50	8,50	8,376	8,676
M 11	1,50	9,50	9,376	9,676
M 12	1,75	10,30	10,106	10,441
M 14	2,00	12,00	11,835	12,210
M 16	2,00	14,00	13,835	14,210
M 18	2,50	15,50	15,294	15,744
M 20	2,50	17,50	17,294	17,744
M 22	2,50	19,50	19,294	19,744
M 24	3,00	21,00	20,752	21,252
M 27	3,00	24,00	23,752	24,252
M 30	3,50	26,50	26,211	26,771
M 33	3,50	29,50	29,211	29,771
M 36	4,00	32,00	31,670	32,270
M 39	4,00	35,00	34,670	35,270
M 42	4,50	37,50	37,129	37,799
M 45	4,50	40,50	40,129	40,799
M 48	5,00	43,00	42,587	43,297
M 52	5,00	47,00	46,587	47,297
M 56	5,50	50,50	50,046	50,796
M 60	5,50	54,50	54,046	54,796
M 64	6,00	58,00	57,505	58,308
M 68	6,00	62,00	61,505	62,305

Filettatura MJ, MJ thread

DIN ISO 5855 - Filetage MJ

MJ	P mm		Ø di foratura 5H - drill sizes - perçage	
			min	max
*MJ 3	0,50	2,60	2,513	2,653
*MJ 4	0,70	3,40	3,318	3,498
*MJ 5	0,80	4,30	4,221	4,421
MJ 6	1	5,10	5,026	5,216
MJ 8	1	7,10	7,026	7,216
MJ 8	1,25	6,90	6,782	6,994
MJ 10	1	9,10	9,026	9,216
MJ 10	1,25	8,90	8,782	8,994
MJ 10	1,5	8,60	8,539	8,775
MJ 12	1,25	10,90	10,782	10,994
MJ 12	1,5	10,60	10,539	10,775
MJ 12	1,75	10,40	10,295	10,560
MJ 14	1,5	12,60	12,539	12,775
MJ 14	2	12,20	12,051	12,351
MJ 16	1,5	14,60	14,539	14,775
MJ 16	2	14,20	14,051	14,351

* Tolleranza - Tolerance - Tolérance: 6H

* Tolleranza - Tolerance - Tolérance: 5H

PREFORI DI MASCHIATURA PER MASCHI AD ASPORTAZIONE

TAPPING DRILL SIZES FOR CUTTING TAPS

PERÇAGE POUR TARAUDAGE NORMAL

Filettatura metrica ISO passo fine DIN 13

ISO metric fine thread DIN 13 - Filetage métrique ISO pas fin DIN13

MF	P mm		Ø di foratura 6H - drill sizes - perçage	
			min	max
M 4	0,5	3,50	3,459	3,599
M 4,5	0,5	4,00	3,959	4,099
M 5	0,5	4,50	4,459	4,599
M 6	0,5	5,50	5,459	5,599
M 6	0,75	5,25	5,188	5,378
M 7	0,75	6,25	6,188	6,378
M 8	0,5	7,50	7,459	7,599
M 8	0,75	7,25	7,188	7,378
M 8	1	7,00	6,917	7,153
M 9	0,75	8,25	8,188	8,378
M 9	1	8,00	7,917	8,153
M 10	0,5	9,50	9,459	9,599
M 10	0,75	9,25	9,188	9,378
M 10	1	9	8,917	9,153
M 10	1,25	8,75	8,647	8,912
M 11	1	10	9,917	10,153
M 12	0,5	11,5	11,459	11,599
M 12	0,75	11,25	11,188	11,378
M 12	1	11	10,917	11,153
M 12	1,25	10,75	10,647	10,912
M 12	1,5	10,5	10,376	10,676
M 13	1	12	11,917	12,153
M 14	1	13	12,917	13,153
M 14	1,25	12,75	12,647	12,912
M 14	1,5	12,5	12,376	12,676
M 15	1	14	13,917	14,153
M 15	1,5	13,5	13,376	13,676
M 16	1	15	14,917	15,153
M 16	1,25	14,8	14,647	14,912
M 16	1,5	14,5	14,376	14,676
M 17	1	16	15,917	16,153
M 17	1,5	15,5	15,376	15,676
M 18	1	17	16,917	17,153
M 18	1,5	16,5	16,376	16,676
M 18	2	16	15,835	16,210
M 20	1	19	18,917	19,153
M 20	1,5	18,5	18,376	18,676
M 20	2	18	17,835	18,210
M 22	1	21	20,917	21,153
M 22	1,5	20,5	20,376	20,676
M 22	2	20	19,835	20,210
M 24	1	23	22,917	23,153
M 24	1,5	22,5	22,376	22,676
M 24	2	22	21,835	22,210
M 25	1	24	23,917	24,153
M 25	1,5	23,5	23,376	23,676
M 25	2	23	22,835	23,210
M 26	1,5	24,5	24,376	24,676
M 27	1	26	25,917	26,153
M 27	1,5	25,5	25,376	25,676
M 27	2	25	24,835	25,210

Filettatura metrica ISO passo fine DIN 13

ISO metric fine thread DIN 13 - Filetage métrique ISO pas fin DIN13

MF	P mm		Ø di foratura 6H - drill sizes - perçage	
			min	max
M 28	1	27	26,917	27,153
M 28	1,5	26,5	26,376	26,676
M 28	2	26	25,835	26,210
M 30	1	29	28,917	29,153
M 30	1,5	28,5	28,376	28,676
M 30	2	28	27,835	28,210
M 30	3	27	26,752	27,252
M 32	1,5	30,5	30,376	30,676
M 32	2	30	29,835	30,210
M 33	1,5	31,5	31,376	31,676
M 33	2	31	30,835	31,210
M 33	3	30	29,752	30,252
M 34	1,5	32,5	32,376	32,676
M 35	1,5	33,5	33,376	33,676
M 36	1,5	34,5	34,376	34,676
M 36	2	34	33,835	34,210
M 36	3	33	32,752	33,252
M 38	1,5	36,5	36,376	36,676
M 39	1,5	37,5	37,376	37,676
M 39	2	37	36,835	37,210
M 39	3	36	35,752	36,252
M 40	1,5	38,5	38,376	38,676
M 40	2	38	37,835	38,210
M 40	3	37	36,752	37,252
M 42	1,5	40,5	40,376	40,676
M 42	2	40	39,835	40,210
M 42	3	39	38,752	39,252
M 42	4	38	37,670	38,270
M 45	1,5	43,5	43,376	43,676
M 45	2	43	42,835	43,210
M 45	3	42	41,752	42,252
M 45	4	41	40,670	41,270
M 48	1,5	46,5	46,376	46,676
M 48	2	46	45,835	46,210
M 48	3	45	44,752	45,252
M 48	4	44	43,670	44,270
M 50	1,5	48,5	48,376	48,676
M 50	2	48	47,835	48,210
M 50	3	47	46,752	47,252
M 52	1,5	50,5	50,376	50,676
M 52	2	50	49,835	50,210
M 52	3	47	46,587	47,087
M 52	4	48	47,670	48,270
M 55	1,5	53,5	53,376	53,676
M 55	2	53	52,835	53,210
M 55	3	52	51,752	52,252
M 55	4	51	50,670	51,270
M 56	1,5	54,5	54,376	54,676
M 56	2	54	53,835	54,210
M 56	3	53	52,752	53,252
M 56	4	52	51,670	52,270

PREFORI DI MASCHIATURA PER MASCHI AD ASPORTAZIONE

TAPPING DRILL SIZES FOR CUTTING TAPS

PERÇAGE POUR TARAUDAGE NORMAL

Filettatura metrica ISO passo fine DIN 13

ISO metric fine thread DIN 13 - Filetage métrique ISO pas fin DIN13

MF	P mm		Ø di foratura 6H - drill sizes - perçage	
			min	max
M 58	1,5	56,5	56,376	56,676
M 58	2	56	55,835	56,210
M 58	3	55	54,752	55,252
M 58	4	54	53,670	54,270
M 60	1,5	58,5	58,376	58,676
M 60	2	58	57,835	58,210
M 60	3	57	56,752	57,252
M 60	4	56	55,670	56,270
M 62	1,5	60,5	60,376	60,676
M 62	2	60	59,835	60,210
M 62	3	59	58,752	59,252
M 62	4	58	57,670	58,270
M 64	1,5	62,5	62,376	62,676
M 64	2	62	61,835	62,210
M 64	3	61	60,752	61,252
M 64	4	60	59,670	60,270
M 65	1,5	63,5	63,376	63,676
M 65	2	63	62,835	63,210
M 65	3	62	61,752	62,252
M 65	4	61	60,670	61,270
M 68	1,5	66,5	66,376	66,676
M 68	2	66	65,835	66,210
M 68	3	65	64,752	65,252
M 68	4	64	63,670	64,270
M 70	1,5	68,5	68,376	68,676
M 70	2	68	67,835	68,210
M 70	3	67	66,752	67,252
M 70	4	66	65,670	66,270
M 70	6	64	63,505	64,305
M 72	1,5	70,5	70,376	70,676
M 72	2	70	69,835	70,210
M 72	3	69	68,752	69,252
M 72	4	68	67,670	68,270
M 72	6	66	65,505	66,305
M 75	1,5	73,5	73,376	73,676
M 75	2	73	72,835	73,210
M 75	3	72	71,752	72,252
M 75	4	71	70,670	71,270
M 76	1,5	74,5	74,376	74,676
M 76	2	74	73,835	74,210
M 76	3	73	72,752	73,252
M 76	4	72	71,670	72,270
M 76	6	70	69,505	70,305
M 80	1,5	78,5	78,376	78,676
M 80	2	78	77,835	78,210
M 80	3	77	76,752	77,252
M 80	4	76	75,670	76,270
M 80	6	74	73,505	74,305
M 85	2	83	82,835	83,210
M 85	3	82	81,752	82,252
M 85	4	81	80,670	81,270
M 85	6	79	78,505	79,305

Filettatura americana UNC ASME B1.1

UNC coarse thread ASME B1.1 - Filetage américain UNC ASME B1.1

UNC	P TPI		Ø di foratura 2B - drill sizes - perçage	
			min	max
Nr. 6	32	2,85	2,642	2,896
Nr. 8	32	3,50	3,302	3,531
Nr. 10	24	3,90	3,683	3,937
Nr. 12	24	4,50	4,343	4,597
1/4	20	5,10	4,978	5,258
5/16	18	6,60	6,401	6,731
3/8	16	8,00	7,798	8,153
7/16	14	9,40	9,144	9,550
1/2	13	10,80	10,592	11,024
9/16	12	12,20	11,989	12,446
5/8	11	13,50	13,386	13,868
3/4	10	16,50	16,307	16,840
7/8	9	19,50	19,177	19,761
1"	8	22,25	21,971	22,606
1"-1/8	7	25,00	24,638	25,349
1"-1/4	7	28,00	27,813	28,524
1"-3/8	6	30,75	30,353	31,155
1"-1/2	6	34,00	33,528	34,290
1"-3/4	5	39,50	38,938	39,802
2"	4,5	45,00	44,679	45,593

Filettatura UNJC ASME B1.15,

UNJC thread ASME B1.15 - Filetage UNJC ASME B1.15

UNJC	P TPI		Ø di foratura 3B - drill sizes	
			min	max
Nr. 6	32	2,80	2,733	2,939
Nr. 8	32	3,50	3,393	3,599
Nr. 10	24	3,90	3,795	4,064
Nr. 12	24	4,60	4,455	4,704
1/4	20	5,20	5,113	5,387
5/16	18	6,70	6,563	6,833
3/8	16	8,10	7,978	8,255
7/16	14	9,50	9,347	9,639
1/2	13	10,90	10,798	11,095
9/16	12	12,35	12,228	12,482
5/8	11	13,80	13,627	13,904
3/4	10	16,70	16,576	16,881

PREFORI DI MASCHIATURA PER MASCHI AD ASPORTAZIONE

TAPPING DRILL SIZES FOR CUTTING TAPS

PERÇAGE POUR TARAUDAGE NORMAL

Filettatura americana UNF ASME B1.1

UNF fine thread ASME B1.1 - Filetage américain UNF ASME B1.1

UNF	P TPI		Ø di foratura 2B - drill sizes - perçage	
			min	max
Nr. 6	40	2,95	2,819	3,023
Nr. 8	36	3,50	3,404	3,607
Nr. 10	32	4,10	3,962	4,166
Nr. 12	28	4,60	4,469	4,724
1/4	28	5,50	5,359	5,588
5/16	24	6,90	6,782	7,036
3/8	24	8,50	8,382	8,636
7/16	20	9,90	9,728	10,033
1/2	20	11,50	11,328	11,608
9/16	18	12,90	12,751	13,081
5/8	18	14,50	14,351	14,681
3/4	16	17,50	17,323	17,678
7/8	14	20,40	20,269	20,676
1"	12	23,25	23,114	23,571
1"-1/8	12	26,50	26,289	26,746
1"-1/4	12	29,50	29,464	29,921
1"-3/8	12	32,75	32,639	33,096
1"-1/2	12	36,00	35,814	36,271

Filettatura americana UNEF ASME B1.1

UNEF extra fine thread ASME B1.1 - Filetage américain UNEF ASME B1.1

UNEF	P TPI		Ø di foratura 2B - drill sizes - perçage	
			min	max
1/4	32	5,55	5,487	5,690
5/16	32	7,15	7,087	7,264
3/8	32	8,7	8,662	8,865
7/16	28	10,2	10,135	10,338
1/2	28	11,8	11,710	11,938
9/16	24	13,2	13,132	13,386
5/8	24	14,8	14,732	14,986
11/16	24	16,4	16,307	16,561
3/4	20	17,8	17,679	17,958
13/16	20	19,4	19,254	19,558
7/8	20	20,95	20,854	21,133
15/16	20	22,50	22,429	22,733
1"	20	24,15	24,029	24,308
1"-1/16	18	25,6	25,451	25,781
1"-1/8	18	27,15	27,051	27,381
1"-3/16	18	28,75	28,626	28,956
1"-1/4	18	30,3	30,226	30,556
1"-3/8	18	33,5	33,401	33,731
1"-7/16	18	35,1	34,976	35,306
1"-1/2	18	36,7	36,576	36,881

Filettatura UNJC ASME B1.15,

UNJC thread ASME B1.15 - Filetage UNJC ASME B1.15

UNJF	P TPI		Ø di foratura 3B - drill sizes - perçage	
			min	max
Nr. 6	40	2,95	2,888	3,053
Nr. 8	36	3,6	3,480	3,663
Nr. 10	32	4,15	4,054	4,255
Nr. 12	28	4,7	4,602	4,816
1/4	28	5,6	5,466	5,662
5/16	24	7	6,906	7,109
3/8	24	8,6	8,494	8,679
7/16	20	10	9,876	10,084
1/2	20	11,55	11,463	11,661
9/16	18	13	12,913	13,122
5/8	18	14,6	14,501	14,702
3/4	16	17,6	17,506	17,722

Filettatura americana 8-UN ASME B1.1

8-UN thread ASME B1.1 - Filetage américain 8-UN ASME B1.1

8-UN	P TPI		Ø di foratura 2B - drill sizes - perçage	
			min	max
1"-1/8	8	25,4	25,146	25,781
1"-1/4	8	28,6	28,321	28,956
1"-3/8	8	31,75	31,496	32,131
1"-1/2	8	34,9	34,671	35,306
1"-5/8	8	38,1	37,846	38,481
1"-3/4	8	41,3	41,021	41,656
1"-7/8	8	44,45	44,196	44,831
2"	8	47,6	47,371	48,006
2"-1/4	8	54	53,721	54,356
2"-1/2	8	60,30	60,071	60,706

PREFORI DI MASCHIATURA PER MASCHI AD ASPORTAZIONE

TAPPING DRILL SIZES FOR CUTTING TAPS

PERÇAGE POUR TARAUDAGE NORMAL

Filettatura GAS Whitworth DIN EN ISO 228

Whitworth pipe thread DIN EN ISO 228

Filetage Gaz cylindrique Whitworth DIN EN ISO 228

GAS	P TPI		Ø di foratura - drill sizes	
			min	max
1/8	28	8,8	8,566	8,848
1/4	19	11,8	11,445	11,890
3/8	19	15,25	14,950	15,395
1/2	14	19	18,631	19,172
5/8	14	21	20,587	21,128
3/4	14	24,5	24,117	24,658
7/8	14	28,25	27,877	28,418
1"	11	30,75	30,291	30,931
1" 1/8	11	35,5	34,939	35,579
1" 1/4	11	39,5	38,952	39,592
1" 1/2	11	45,25	44,845	45,485
1" 3/4	11	51,10	50,788	51,428
2"	11	57	56,656	57,296
2" 1/4	11	63,10	62,752	63,392
2" 1/2	11	72,6	72,226	72,866
2" 3/4	11	79	78,576	79,216
3"	11	85,3	84,926	85,566

Filettatura gas cilindrica americana sec. ANSI B1.20.1

American Standard straight pipe thread acc. ANSI B1.20.1

Filetage Gaz cylindrique américain ANSI B 1.20.1

NPSM (NPSC)	P TPI		Ø di foratura - drill sizes	
			NPSM	NPSC
1/8	27		9,10	8,8
1/4	18		12	11,40
3/8	18		15,5	14,8
1/2	14		19	18,5
3/4	14		24,5	23,8
1"	11,5		30,5	29,9

Filettatura gas cilindrica americana sec. ANSI B1.20.3

American Standard straight pipe thread acc. ANSI B1.20.3

Filetage Gaz cylindrique américain ANSI B 1.20.3

NPSF	P TPI		Ø di foratura - drill sizes	
			min	max
1/8	27	8,7	8,651	
1/4	18	11,30	11,232	
3/8	18	14,7	14,671	
1/2	14	18,2	18,118	
3/4	14	23,50	23,465	
1"	11,5	29,50	29,464	

Filettatura interna GAS cilindrica Whitworth ISO 7-1

Cylindrical Whitworth internal pipe thread ISO 7-1

Filetage Gaz interne cylindrique Whitworth ISO 7 -1

Rp	P TPI		Ø di foratura - drill sizes	
			min	max
1/8	28	8,6	8,495	8,637
1/4	19	11,5	11,341	11,549
3/8	19	15	14,846	15,054
1/2	14	18,5	18,489	18,773
3/4	14	24	23,975	24,259
1"	11	30,25	30,111	30,471
1" 1/4	11	39	38,772	39,132
1" 1/2	11	45	44,665	45,025
2"	11	56,5	56,476	56,836

Filettatura GAS Whitworth DIN EN ISO 228

Whitworth pipe thread DIN EN ISO 228

Filetage Gaz cylindrique Whitworth DIN EN ISO 228

BSW	P TPI		Ø di foratura - drill sizes	
			min	max
1/8	40	2,5	2,362	2,591
3/16	24	3,6	3,407	3,745
1/4	20	5	4,724	5,156
5/16	18	6,5	6,130	6,590
3/8	16	7,9	7,492	7,987
7/16	14	9,2	8,789	9,330
1/2	12	10,5	9,989	10,591
9/16	12	12	11,577	12,179
5/8	11	13,4	12,918	13,558
3/4	10	16,4	15,797	16,483
7/8	9	19,25	18,611	19,353
1"	8	22	21,334	22,147
1" 1/8	7	24,75	23,928	24,832
1" 1/4	7	27,5	27,103	28,007
1" 1/2	6	33,5	32,679	33,703

PREFORI DI MASCHIATURA PER MASCHI AD ASPORTAZIONE

TAPPING DRILL SIZES FOR CUTTING TAPS

PERÇAGE POUR TARAUDAGE NORMAL

Filettatura per tubi corazzati DIN 40430

Steel conduit thread DIN 40430 - Filetage pour tube blindés DIN 40430

PG	P TPI		Ø di foratura - drill sizes	
			min	max
PG 7	20	11,4	11,28	11,43
PG 9	18	14	13,86	14,01
PG 11	18	17,25	17,26	17,41
PG 13,5	18	19	19,06	19,21
PG 16	18	21,25	21,16	21,31
PG 21	16	27	26,78	27,03
PG 29	16	35,5	35,48	35,73
PG 36	16	45,5	45,48	45,73
PG 42	16	52,5	52,48	52,73
PG 48	16	58	57,78	58,03

Filettatura tonda DIN 405

Round thread DIN 405 - Filetage rond DIN 405

Rd	P TPI		Ø di foratura - drill sizes	
			min	max
8	10	6	5,714	6,274
9	10	7	6,714	7,274
10	10	8	7,714	8,274
11	10	9	8,714	9,274
12	10	10	9,714	10,274
14	8	11,5	11,142	11,812
16	8	13,5	13,142	13,812
18	8	15,5	15,142	15,812
20	8	17,5	17,142	17,812
22	8	19,5	19,142	19,812
24	8	21,5	21,142	21,812
26	8	23,5	23,142	23,812
28	8	25,5	25,142	25,812
30	8	27,5	27,142	27,812

Filettatura ISO metrica trapezoidale DIN 103

ISO Metric trapezoidal thread DIN 103

Filetage ISO métrique trapézoïdal DIN 103

TR	P mm		Ø di foratura - drill sizes	
			min	max
10	2	8,2	8,000	8,236
10	3	7,5	-	-
12	2	10,2	10,000	10,236
12	3	9,25	9,000	9,315
14	3	11,25	11,000	11,315
14	4	10,5	-	-
16	4	12,25	12,000	12,375
18	4	14,25	14,000	14,375
20	4	16,25	16,000	16,375
22	5	17,25	17,000	17,450
24	5	19,25	19,000	19,450
26	5	21,25	21,000	21,450
28	5	23,25	23,000	23,450
30	6	24,25	24,000	24,500
32	6	26,25	26,000	26,500
36	6	30,25	30,000	30,500

Filettatura ISO metrica DIN 8140-2 per filetti riportati

ISO Metric coarse thread DIN 8140-2 for wire thread inserts (STI)

Filetage métrique ISO DIN8140-2 pour HELICOIL (filet-rapporté)

EGM	P mm		Ø di foratura - drill sizes	
			min	max
2	0,4	2,10	2,087	2,177
2,5	0,45	2,65	2,597	2,697
3	0,5	3,15	3,108	3,22
3,5	0,6	3,70	3,630	3,755
4	0,7	4,20	4,152	4,292
5	0,8	5,25	5,174	5,344
6	1	6,30	6,217	6,407
7	1	7,30	7,217	7,407
8	1,25	8,40	8,217	8,483
9	1,25	9,40	9,217	9,483
10	1,5	10,50	10,324	10,560
11	1,5	11,50	11,324	11,560
12	1,75	12,50	12,379	12,644
14	2	14,50	14,433	14,733
16	2	16,50	16,433	16,733
18	2,5	18,75	18,541	18,986
20	2,5	20,75	20,541	20,896

PREFORI PER MASCHIATURA CONICA

TAPPING DRILL SIZES FOR CONICAL THREADING

PERÇAGE POUR LE TARAUDAGE CONIQUE

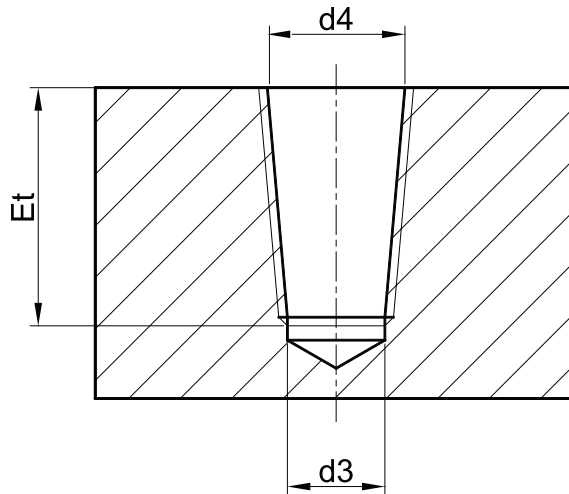

Filettatura gas conica americana, conicità 1:16 sec. ANSI/ASME B1.20.1

American tapered pipe thread, taper 1:16 acc. ANSI/ASME B1.20.1 - Filetage gaz conique américain, à cône 01:16 ANSI/ASME B 1.20.1

NPT

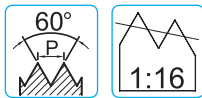

Ød1	P TPI	d3 cil./cyl. mm	d4 con./taper mm	Et = X
1/16	27	6,20	6,39	9,30
1/8	27	8,50	8,74	9,30
1/4	18	11	11,36	13,50
3/8	18	14,50	14,80	13,90
1/2	14	17,9	18,32	18,10
3/4	14	23,2	23,67	18,60
1"	11,5	29,00	29,69	22,30
1 1/4"	11,5	37,8	38,45	22,80
1 1/2"	11,5	44	44,52	22,80
2"	11,5	56	56,56	23,20

Filettatura gas conica americana, conicità 1:16 sec. ANSI/ASME B1.20.3

American tapered pipe thread, taper 1:16 acc. ANSI/ASME B1.20.3 - Filetage gaz conique American, à cône 01:16 ANSI/ASME B 1.20.3

NPTF

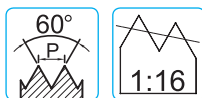

Ød1	P TPI	d3 cil./cyl. mm	d4 con./taper mm	Et = X
1/16	27	6,10	6,41	9,30
1/8	27	8,45	8,76	9,30
1/4	18	10,9	11,4	13,50
3/8	18	14,3	14,84	13,90
1/2	14	17,6	18,33	18,10
3/4	14	23,0	23,68	18,60
1"	11,5	28,75	29,72	22,30
1 1/4"	11,5	37,5	38,48	22,80
1 1/2"	11,5	43,75	44,55	22,80
2"	11,5	55,75	56,59	23,20

Filettatura gas conica Whitworth, conicità 1:16, ISO 7-1

Tapered Whitworth pipe thread, taper 1:16, ISO 7-1 - Filetage gaz conique Whitworth, à cône 01:16 ISO 7-1

Rc

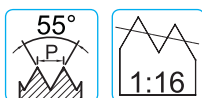

Ød1	P TPI	d3 cil./cyl. mm	d4 con./taper mm	Et = X
1/8	28	8,20	8,57	10,1
1/4	19	11	11,45	15,0
3/8	19	14,5	14,95	15,4
1/2	14	18	18,63	20,4
3/4	14	23,5	24,12	21,7
1"	11	29,5	30,29	26
1 1/4"	11	38	38,95	28,3
1 1/2"	11	44	44,85	28,3
2"	11	55,5	56,66	32,6

PREFORI DI MASCHIATURA PER MASCHI A RULLARE

TAPPING DRILL SIZES FOR ROLLING TAPS

PERÇAGE POUR LES TARAUDS À REFOULER

Filettatura metrica ISO DIN 13

ISO metric coarse thread DIN 13 - Filetage métrique ISO DIN13

M	P mm		Toll.
2	0,4	1,82	± 0,02
2,2	0,45	2,00	± 0,02
2,3	0,4	2,1	± 0,02
2,5	0,45	2,30	± 0,02
2,6	0,45	2,40	± 0,02
3	0,5	2,8	± 0,03
3,5	0,6	3,25	± 0,03
4	0,7	3,70	± 0,03
5	0,8	4,65	± 0,03
6	1	5,55	± 0,05
8	1,25	7,40	± 0,05
10	1,5	9,30	± 0,05
12	1,75	11,20	± 0,05
14	2	13,10	± 0,05
16	2	15,10	± 0,05
18	2,5	16,90	± 0,05
20	2,5	18,90	± 0,05
22	2,5	20,90	± 0,05
24	3	22,70	± 0,05

Filettatura metrica ISO passo fine DIN 13

ISO metric fine thread DIN 13 - Filetage métrique ISO pas fin DIN13

MF	P mm		Toll.
4	0,5	3,80	±0,03
5	0,5	4,80	±0,03
6	0,5	5,80	±0,03
6	0,75	5,65	±0,03
8	1	7,55	±0,05
10	1	9,55	±0,05
10	1,25	9,40	±0,05
12	1	11,55	±0,05
12	1,25	11,40	±0,05
12	1,5	11,30	±0,05
14	1	13,55	±0,05
14	1,25	13,40	±0,05
14	1,5	13,30	±0,05
16	1	15,55	±0,05
16	1,25	15,40	±0,05
16	1,5	15,30	±0,05
18	1	17,55	±0,05
18	1,25	17,40	±0,05
18	1,5	17,30	±0,05
20	1	19,55	±0,05
20	1,25	19,40	±0,05
20	1,5	19,30	±0,05
20	2	19,10	±0,05
22	1	21,55	±0,05
22	1,25	21,40	±0,05
22	1,5	21,30	±0,05
22	2	21,10	±0,05
24	1	23,55	±0,05
24	1,25	23,40	±0,05
24	1,5	23,30	±0,05
24	2	23,10	±0,05
26	1,5	25,30	±0,05
26	2	25,10	±0,05
27	1,5	26,30	±0,05
27	2	26,10	±0,05
28	1,5	27,30	±0,05
28	2	27,10	±0,05
30	1,5	29,30	±0,05
30	2	29,10	±0,05

PREFORI DI MASCHIATURA PER MASCHI A RULLARE

TAPPING DRILL SIZES FOR ROLLING TAPS

PERÇAGE POUR LES TARAUDS À REFOULER

Filettatura americana UNC ASME B1.1

UNC coarse thread ASME B1.1 - Filetage américain UNC ASME B1.1

UNC	P TPI		Toll.
6	32	3,15	±0,03
8	32	3,80	±0,03
10	24	4,30	±0,05
12	24	5,00	±0,05
1/4	20	5,75	±0,05
5/16	18	7,25	±0,05
3/8	16	8,75	±0,05
7/16	14	10,30	±0,05
1/2	13	11,80	±0,05
9/16	12	13,30	±0,05
5/8	11	14,80	±0,05
3/4	10	17,9	±0,05
7/8	9	21	±0,05
1'	8	24	±0,05

Filettatura americana UNF ASME B1.1

UNF fine thread ASME B1.1 - Filetage américain UNF ASME B1.1

UNF	P TPI		Toll.
6	40	3,20	±0,03
8	36	3,85	±0,03
10	32	4,45	±0,03
12	28	5,05	±0,05
1/4	28	5,90	±0,05
5/16	24	7,45	±0,05
3/8	24	9,00	±0,05
7/16	20	10,50	±0,05
1/2	20	12,10	±0,05
9/16	18	13,70	±0,05
5/8	18	15,25	±0,05
3/4	16	18,40	±0,05
7/8	14	21,40	±0,05
1'	12	24,45	±0,05
1'-1/8	12	27,60	±0,05
1'-1/4	12	30,80	±0,05
1'-3/8	12	34,00	±0,05
1'-1/2	12	37,15	±0,05

Filettatura GAS Whitworth DIN EN ISO 228

Whitworth pipe thread DIN EN ISO 228

Filetage Gaz cylindrique Whitworth DIN EN ISO 228

GAS	P TPI		Toll.
1/16	28	7,25	±0,05
1/8	28	9,25	±0,05
1/4	19	12,5	±0,05
3/8	19	16	±0,05
1/2	14	20	±0,05
5/8	14	22	±0,05
3/4	14	25,5	±0,05
7/8	14	29,25	±0,05
1'	11	32	±0,05
1'-1/8	11	36,70	±0,05
1'-1/4	11	40,70	±0,05

CLASSI DI TOLLERANZA DEI MASCHI-EN22857

TOLERANCE CLASSES OF TAPS - EN 22857

CLASSES DE TOLÉRANCE DES TARAUDS - EN 22857

ISO	Maschio - Tap -Taraud DIN	ANSI/ASME	Madrevite Internal thread, nut - Vis-Mère				Accoppiamento Fit - Accouplement	
ISO 1	4H	3B	4H	5H			Senza gioco <i>Fit without allowance - Sans jeu</i>	
ISO 2	6H	2B	4G	5G	6H		Con gioco standard <i>Standard fit - Avec jeu standard</i>	
ISO 3	6G	1B			6G	7H	8H	Con gioco speciali <i>Special fit with allowance - Avec jeu spécial</i>
	7G					7G	8G	Largo per successivi rivestimenti <i>Loose fit, for subsequent coating Large pour les revêtements subséquents</i>

Posizione della tolleranza

Tolerance classes - Emplacement de la tolérance

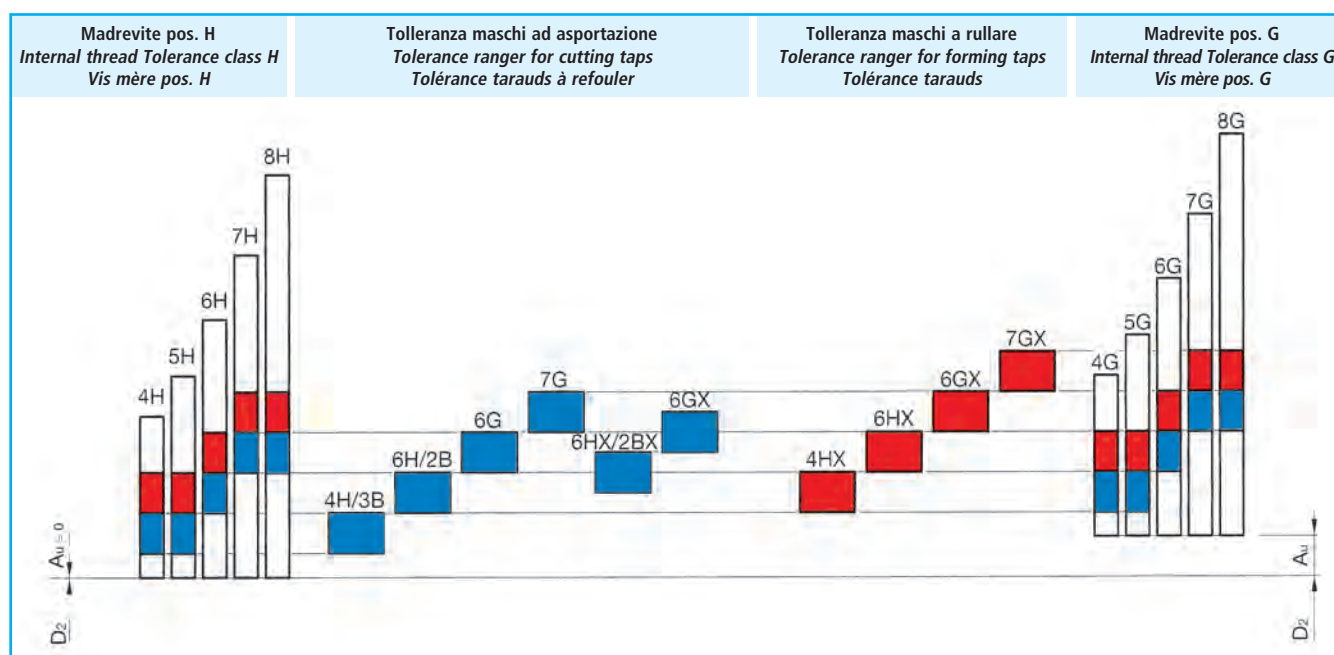

L'accoppiamento più comunemente utilizzato è quello relativo alle classe ISO 2, 6H o 2B. Per accoppiamenti più precisi, senza gioco tra i fianchi del filetto, deve essere utilizzato un accoppiamento "più stretto" di classe ISO 1, 4H o 3B. Le tolleranze ISO 3, 6G o 1B sono utilizzate per accoppiamenti grossolani, applicate nel caso di ricoprimenti superficiali successivi al processo di filettatura.

Standard fit for a thread is according tolerance ISO 2, 6H or 2B and so, for more precise fit, without any allowance on thread flanks, You have to choose ISO 1, 4H and 3B, for American threading. For following coatings to be applied after threading You have to use ISO 3, 6G, 1B.

Le couplage plus couramment utilisé est lié à la classe ISO 2, 6H ou 2B. Pour les assemblages plus précis sans jeu entre les côtés du filet, doit être utilisé un « resserrement » ISO classe 1, 4H ou 3B. Tolérances ISO 3, 6G ou 1B sont utilisés pour les pas grossiers, appliqués dans le cas des revêtements de surface suite au processus de taraudage.

Vengono inoltre realizzate tolleranze intermedie 6HX e 6GX applicate su tipologie di maschi che lavorano materiali abrasivi, come la ghisa, per aumentare la durata. Un'altra applicazione delle tolleranze intermedie X è quella relativa ai maschi a rullare, che realizzano la filettatura mediante processo di deformazione plastica; in questo caso, ad esempio, per ottenere una filettatura 6H il maschio viene realizzato in tolleranza 6HX per compensare il ritorno elastico del materiale lavorato.

Taps manufacturers produce taps with tolerance 6HX and 6GX and not only 6H and 6G. These taps are used for cast iron, to increase tools'life or for forming taps. In those cases You have to use 6HX tap to compensate the elastic return of the material.

Il a également les 6GX 6HX tolérances intermédiaire appliquées et sur les types de tarauds travaillant les matériaux abrasifs, comme la fonte, pour une durabilité accrue. Une autre application de tolérances intermédiaire X sont les tarauds à refouler, effectuant le filetage à travers les processus de déformation plastique; dans ce cas, par exemple, pour obtenir un 6H le taraud est en tolérance 6HX pour compenser le retour élastique du matériau travaillé.

Nelle pagine successive sono riportati gli scostamenti standard (6H e 2B) per le filettature M, MF, UNC, UNF e GAS.

In the following pages shows the standard fit (6H and 2B) for threads M, MF, UNC, UNF and GAS

Dans les pages qui suivent sont les écarts-types (6H et 2B) pour les filetages M, MF, UNC, UNF et GAZ

TOLLERANZE DI FABBRICAZIONE SUI DIAMETRI MEDI DEI MASCHI

MANUFACTURING TOLERANCES ON PITCH DIAMETER

TOLÉRANCES DE LA FABRICATION SUR LES DIAMÈTRES MOYENS DES TARAUDS

M - ISO Passo GROSSO - ISO Metric Coarse Thread - M-ISO pas gros

Ød1	P mm	Diametri medi 6H Pitch diameter 6H - Diamètres moyens 6H	
		Min	Max
2	0,4	1,761	1,776
2,5	0,45	2,231	2,246
3	0,5	2,699	2,715
3,5	0,6	3,137	3,155
4	0,7	3,574	3,593
4,5	0,75	4,042	4,061
5	0,8	4,510	4,530
6	1	5,385	5,409
7	1	6,385	6,409
8	1,25	7,226	7,251
9	1,25	8,226	8,251
10	1,5	9,068	9,096
11	1,5	10,068	10,096
12	1,75	10,911	10,943
14	2	12,752	12,786
16	2	14,752	14,786
18	2,5	16,430	16,466
20	2,5	18,430	18,466
22	2,5	20,430	20,466
24	3	22,115	22,157
27	3	25,115	25,157
30	3,5	27,794	27,839
33	3,5	30,794	30,839
36	4	33,473	33,520
39	4	36,473	36,520
42	4,5	39,152	39,202
45	4,5	42,152	42,202
48	5	44,832	44,885
52	5	48,832	48,885
56	5,5	52,512	52,568
60	5,5	56,512	56,568
64	6	60,193	60,253
68	6	64,193	64,253

M, MF, UNC, UNF

Dimensioni in mm
Dimensions in mm

$$H = 0,86603 P$$

$$H_1 = \frac{5}{8} H = 0,54127 P$$

$$h_3 = \frac{17}{24} H = 0,61343 P$$

$$d_2 = D_2 = d - \frac{3}{4} H = d - 0,64952 P$$

$$d_3 = d - 2 h_3 = d - 1,22387 P$$

$$r = \frac{H}{6} = 0,14434 P$$

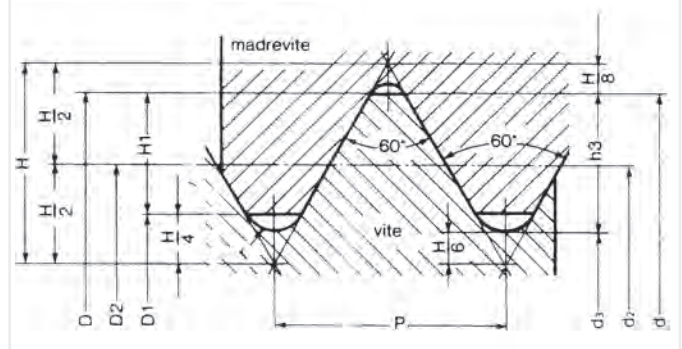

MF - ISO Passo FINE - ISO Metric Fine Thread - MF-ISO pas fin

Ød1	P mm	Diametri medi 6H Pitch diameter 6H - Diamètres moyens 6H	
		Min	Max
2,5	0,35	2,293	2,307
3	0,35	2,794	2,809
3,5	0,35	3,294	3,309
4	0,5	3,699	3,715
4,5	0,5	4,199	4,215
5	0,5	4,699	4,715
5,5	0,5	5,199	5,215
6	0,75	5,545	5,566
7	0,75	6,545	6,566
8	1	7,385	7,409
9	1	8,385	8,409
10	1	9,385	9,409
10	1,25	9,226	9,251
12	1,25	11,230	11,258
12	1,5	11,071	11,101
14	1,25	13,230	13,258
12	1,5	11,071	11,101
15	1,5	14,071	14,101
16	1,5	15,071	15,101
17	1,5	16,071	16,101
18	1,5	17,071	17,101
18	2	16,752	16,786
20	1,5	19,071	19,101
20	2	18,752	18,786
22	1,5	21,071	21,101
22	2	20,752	20,786
24	1,5	23,074	23,106
24	2	22,755	22,791
25	1,5	24,074	24,106
25	2	23,755	23,791
27	1,5	26,074	26,106
27	2	25,755	25,791
28	1,5	27,074	27,106
28	2	26,755	26,791
30	1,5	29,074	29,106
30	2	28,755	28,791
30	3	28,115	28,157
32	1,5	31,074	31,106
32	2	30,755	30,791
33	1,5	32,074	32,106
33	2	31,755	31,791
33	3	31,115	31,157

Ød1	P mm	Diametri medi 6H Pitch diameter 6H - Diamètres moyens 6H	
		Min	Max
35	1,5	34,074	34,106
36	1,5	35,074	35,106
36	2	34,755	34,791
36	3	34,115	34,157
39	1,5	38,074	38,106
39	2	37,755	37,791
39	3	37,115	37,157
40	1,5	39,074	39,106
40	2	38,755	38,791
40	3	38,115	38,157
42	1,5	41,074	41,106
42	2	40,755	40,791
42	3	40,115	40,157
42	4	39,473	39,520
45	1,5	44,074	44,106
45	2	43,755	43,791
45	3	43,115	43,157
45	4	42,473	42,520
48	1,5	47,077	47,111
48	2	46,758	46,796
48	3	46,118	46,163
48	4	45,477	45,527
50	1,5	49,077	49,111
50	2	48,758	48,796
50	3	48,118	48,163
52	1,5	51,077	51,111
52	2	50,758	50,796
52	3	50,118	50,163
55	4	52,477	52,527
55	1,5	54,077	54,111
55	2	53,758	53,796
55	3	53,118	53,163
55	4	52,477	52,527
56	1,5	55,077	55,111
56	2	54,758	54,796
56	3	54,118	54,163
56	4	53,477	53,527

TOLLERANZE DI FABBRICAZIONE SUI DIAMETRI MEDI DEI MASCHI

MANUFACTURING TOLERANCES ON PITCH DIAMETER

TOLÉRANCES DE LA FABRICATION SUR LES DIAMÈTRES MOYENS DES TARAUDS

Filettatura **UNC** (ASME B1.1) - UNC Coarse Thread - Filetage UNC

Ød1	P TPI	Diametri medi 2B	
		Pitch diameter 2B - Diamètres moyens 2B Min	Max
Nr. 1	64	1,611	1,626
Nr. 2	56	1,904	1,919
Nr. 3	48	2,186	2,201
Nr. 4	40	2,447	2,462
Nr. 5	40	2,777	2,792
Nr. 6	32	3,009	3,029
Nr. 8	32	3,670	3,690
Nr. 10	24	4,158	4,178
Nr. 12	24	4,818	4,838
1/4	20	5,570	5,590
5/16	18	7,066	7,086
3/8	16	8,538	8,558
7/16	14	9,979	9,999
1/2	13	11,475	11,495
9/16	12	12,957	12,977
5/8	11	14,425	14,445
3/4	10	17,450	17,470
7/8	9	20,452	20,472
1	8	23,397	23,417
1-1/8	7	26,292	26,317
1-1/4	7	29,467	29,492
1-3/8	6	32,249	32,274
1-1/2	6	35,424	35,449
1-3/4	5	41,240	41,270
2	5	47,223	47,253
2-1/4	5	53,583	53,603
2-1/2	4	59,475	59,495
2-3/4	4	65,826	65,846
3	4	72,176	72,196

Filettatura **UNF** (ASME B1.1) - UNF Fine Thread - Filetage UNF

Ød1	P TPI	Diametri medi 2B	
		Pitch diameter 2B - Diamètres moyens 2B Min	Max
Nr. 0	80	1,333	1,348
Nr. 1	72	1,640	1,655
Nr. 2	64	1,941	1,956
Nr. 3	56	2,235	2,250
Nr. 4	48	2,516	2,531
Nr. 5	44	2,815	2,830
Nr. 6	40	3,107	3,122
Nr. 8	36	3,727	3,747
Nr. 10	32	4,330	4,350
Nr. 12	28	4,916	4,936
1/4	28	5,800	5,820
5/16	24	7,290	7,310
3/8	24	8,877	8,897
7/16	20	10,333	10,353
1/2	20	11,920	11,940
9/16	18	13,416	13,436
5/8	18	15,004	15,024
3/4	16	18,064	18,084
7/8	14	21,097	21,127
1	12	24,075	24,105
1-1/8	12	27,250	27,280
1-1/4	12	30,425	30,455
1-3/8	12	33,600	33,630
1-1/2	12	36,775	36,805

GAS

Dimensioni in mm
Dimensions in mm

$$P = \frac{25,4}{z}$$

$$H = 0,960\ 491\ P$$

$$H_1 = 0,640\ 327\ P$$

$$r = 0,137\ 329\ P$$

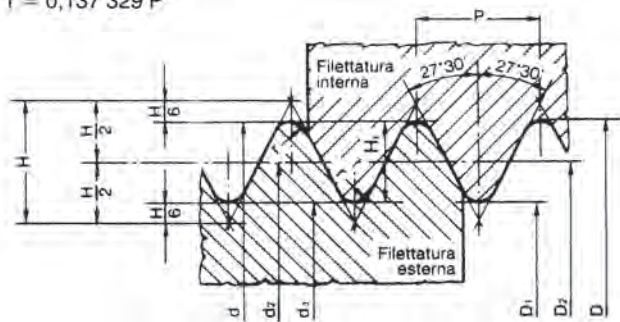

Filettatura **GAS** Cilindrica

Whitworth pipe Thread - Filetage GAZ cylindrique

Ød1	P TPI	Diametri medi 2B	
		Pitch diameter - Diamètres moyens Min	Max
1/8	28	9,189	9,209
1/4	19	12,349	12,369
3/8	19	15,849	15,869
1/2	14	19,848	19,868
5/8	14	21,798	21,818
3/4	14	25,328	25,348
7/8	14	29,088	29,108
1	11	31,831	31,851
1-1/8	11	36,481	36,501
1-1/4	11	40,491	40,511
1-3/8	11	42,901	42,921
1-1/2	11	46,391	46,411
1-3/4	11	52,351	52,371
2	11	58,211	58,231
2-1/4	11	64,321	64,341
2-3/8	11	68,011	68,031
2-1/2	11	73,791	73,811
2-3/4	11	80,151	80,171
3	11	86,501	86,521
3-1/4	11	92,601	92,621
3-1/2	11	98,951	98,971
3-3/4	11	105,301	105,321
4	11	111,651	111,671

RIVESTIMENTI E TRATTAMENTI SUPERFICIALI

COATINGS AND SURFACE TREATMENTS

REVÊTEMENTS ET TRAITEMENTS DE SURFACE

	Codice UFS	Microdurezza HV 0,05	Coefficiente di attrito	Temperatura di massima lavorazione	Proprietà	Applicazione
	UFS Code	Micro hardness Micro - dureté	Friction coefficient Coefficient frottement	Max working temperature Température travail max.	Propriétés Propriétés	Applications Application
TiN	T	2300	0,4	600	◇	Rivestimento di base per applicazioni generali e lavorazione degli acciai basso e medio legati. <i>Coating for general applications and machining low and medium alloy steels.</i> <i>Revêtement de base pour les applications générales et le traitement de bas- et moyen des aciers alliés.</i>
TiN-G	TG	2300	0,2	600	◇	Applicazioni generali per maschiatura a rullare ad alto rendimento, UFS TOP serie X2 ed X3. <i>General applications for high-performance former taps, UFS TOP series X2 and X3.</i> <i>Applications générales pour taraudage à refouler à haut rendement, UFS TOP série X2 et X3.</i>
TiCN	CT	3000	0,4	400	◇	Applicazione su materiali abrasivi come la ghisa, leghe di nichel e titanio. <i>Application on abrasive materials (ex. cast iron), nickel and titanium alloys.</i> <i>Application sur les matériaux abrasifs tels que fonte, alliages de nickel et de titane.</i>
CrN Nitrato di cromo Chromium nitride Nitrure de chrome	NC	3000	0,25	850	◆ *	Applicazione su acciaio di medio - bassa resistenza. Particolarmente indicato per rame, ottone, bronzo e zama. <i>Application on medium - low resistance steel. Particularly suitable for copper, brass, bronze and zamak.</i> <i>Application sur acier de moyenne- faible résistance. Particulièrement adapté pour le cuivre, laiton, Laiton et zamak.</i>
TiAlN Tinalox	TX	3500	0,4	900	◆	Applicazione per materiali abrasivi (ghisa), a secco e per alte velocità di taglio. Lavorazioni su acciai ad alta resistenza legati e temprati. <i>Application for abrasive materials (cast iron), dry machining and for high speed cutting. Working on high-strength alloy steel and hardened.</i> <i>Application pour matériaux abrasifs (fonte), Usinage a sec et haute vitesses. Travaillant sur les aciers à haute résistance et prés-traités.</i>
ZrN Nitrato di zirconio Zirconium nitride Nitrure de zirconium	TZ	1600	-	-	*	Ad esaurimento scorte o su richiesta. Applicazione per alluminio e sue leghe. <i>Exhausted for standard item or on request.</i> <i>Application for aluminium and its alloys.</i> <i>Sur demande épousement des stocks.</i> <i>Application pour l'aluminium et ses alliages.</i>
VS Vaporizzazione Super Super steam tempering Vaporisation Super	VS	1600	0,15	380	*	Nuovo rivestimento di ultima generazione, evoluzione della classica vaporizzazione. Trova applicazione su alluminio a basso contenuto di silicio, acciai dolci e materiali teneri con tendenza ad incollare. <i>New coating, latest generation, evolution of the classic steam tempering for low % Si aluminium, low resistance steel and soft materials with a tendency to stick.</i> <i>Nouvelle génération de revêtement, évolution de la vaporisation classique. Application sur l'aluminium à faible pourcentage de silicium, aciers doux et matériaux tendre avec tendance de soudure a froid.</i>
XP TiN-X Plus	XP	2300	0,15	600	◇ *	Nuovo rivestimento per acciai di medio bassa resistenza, particolarmente consigliato per maschiatura compensata. <i>New coating for medium-low resistance steel, recommended for tapping with axial compensation.</i> <i>Nouveau revêtement pour les aciers de moyenne - faible Résistance, particulièrement recommandée pour Taraudage compensé.</i>
TXC Tinalox + Carbon	TXC	3500	0,15	850	◆ *	Combinazione di un rivestimento 3500 HV ed uno strato autolubrificante, consigliato per maschiatura di fori ciechi profondi. Applicazione su INOX ed Alluminio con alto contenuto di Si. <i>Combination of a coating 3500 HV and a lubricating layer, recommended for tapping blind deep holes. Application on stainless steel and aluminium with a high % of Si.</i> <i>Combinaison d'un revêtement de 3500 HV et une couche autolubrificant recommandé pour exploiter des trous borgnes profonds.</i> <i>Application pour acier inoxydable et aluminium à haute teneur de Si.</i>

RIVESTIMENTI E TRATTAMENTI SUPERFICIALI

COATINGS AND SURFACE TREATMENTS

REVÊTEMENTS ET TRAITEMENTS DE SURFACE

	Codice UFS	Microdurezza HV 0,05	Coefficiente di attrito	Temperatura di massima lavorazione	Proprietà	Applicazione
	UFS Code	Micro hardness Micro - dureté	Friction coefficient Coefficient frottement	Max working temperature Température travail max.	Properties Propriétés	Applications Application
V Vaporizzazione Steam Tempering Vaporisation	V	400	-	-	*	Trattamento superficiale di base indicato per la lavorazione degli acciai dolci o basso legati, acciai automatici (AVP) e alluminio puro o con basso contenuto di silicio. <i>Basic surface treatment suited for machining soft steel, low alloy steels, automatic steel (AVP), pure aluminium and aluminium low % Si.</i> Traitement de surface base propres à la transformation des aciers doux ou faiblement alliés, Acier de décolletage (AVP) et aluminium pur ou à faible composition de silicium.
NQ Nitrurazione NQ Nitriding NQ Nituration NQ	NQ	1300	-	-	◇	Trattamento superficiale di tipo tradizionale utilizzato per lavorazioni della ghisa e del bronzo a truciolo corto. <i>Traditional surface treatment used for machining cast iron and short chip bronze.</i> Traitement de surface traditionnel Utilisé pour l'usinage de la fonte et bronze copeaux courts.
TXS	TXS	3200	0,25	1100	*	Applicazione su ghisa ed elevata resa produttiva. <i>Application for cast iron and high yield.</i> Application sur la fonte et à haut rendement.

◇ Resistenza all'usura

Wear resistance - Résistance à l'usure

◆ Resistenza all'usura e all'ossidazione

Oxidation and wear resistance - Résistance à l'usure et l'oxydation

* Facilita lo scorrimento del truciolo

Chip evacuation - Fluage du copeau

* Resistenza all'usura, stabilità termica, durezza a caldo

Wear resistance, thermal shock stability and hot hardness - Résistance à l'usure, stabilité thermique, dureté chaude

VAPORIZZAZIONE

STEAM TEMPERING - VAPORISATION

TiN

TiN

Tanti sono i trattamenti superficiali specifici per i materiali da filettare, ma volendo semplificare al massimo, 2 sono quelli che si dividono la maggior percentuale d'impiego e, quindi, di vendita.

There are so many specific surface treatments for threaded materials, but to simplify it as much as possible, most applications use two different types.

Il existe de nombreux traitements de surface spéciaux pour les matériaux à fileter, mais pour vouloir simplifier au maximum, 2 sont ceux qui divisent le plus grand pourcentage d'utilisation et de vente.



COMPARAZIONE DUREZZE

HARDNESS COMPARISON TABLE

COMPARAISON DE DURETÉ

HV Vickers Durezza <i>Hardness - Dureté</i>	HRC Rockwell Durezza <i>Hardness - Dureté</i>	HB Brinell Durezza <i>Hardness - Dureté</i>	Resistenza <i>Tensile Strength - Résistance</i>	
			N/mm ²	Tons/sq. in.
940	68			
900	67			
864	66			
829	65			
800	64			
773	63			
745	62			
720	61			
698	60			
675	59			
655	58		2200	142
650		618	2180	141
640		608	2145	139
639	57	607	2140	138
630		599	2105	136
620		589	2070	134
615	56	584	2050	133
610		580	2030	131
600		570	1995	129
596	55	567	1980	128
590		561	1955	126
580		551	1920	124
578	54	549	1910	124
570		542	1880	122
560	53	532	1845	119
550		523	1810	117
544	52	517	1790	116
540		513	1775	115
530		504	1740	113
527	51	501	1730	112
520		494	1700	110
514	50	488	1680	109
510		485	1665	108
500		475	1630	105
497	49	472	1620	105
490		466	1595	103
484	48	460	1570	102
480		456	1555	101
473	47	449	1530	99
470		447	1520	98
460		437	1485	96
458	46	435	1480	96
450		428	1455	94
446	45	424	1440	93
440		418	1420	92

HV Vickers Durezza <i>Hardness - Dureté</i>	HRC Rockwell Durezza <i>Hardness - Dureté</i>	HB Brinell Durezza <i>Hardness - Dureté</i>	Resistenza <i>Tensile Strength - Résistance</i>	
			N/mm ²	Tons/sq. in.
434	44	416	1400	91
423	43	402	1360	88
413	42	393	1330	86
403	41	383	1300	84
392	40	372	1260	82
382	39	363	1230	80
373	38	354	1200	78
364	37	346	1170	76
355	36	337	1140	74
350		333	1125	73
345	35	328	1110	72
340		323	1095	71
336	34	319	1080	70
330		314	1060	69
327	33	311	1050	68
320		304	1030	67
317	32	301	1020	66
310	31	295	995	64
302	30	287	970	63
300		285	965	62
295		280	950	61
293	29	278	940	61
290		276	930	60
287	28	273	920	60
285		271	915	59
280	27	266	900	58
275		261	880	57
272	26	258	870	56
270		257	865	56
268	25	255	860	56
265		252	850	55
260	24	247	835	54
255	23	242	820	53
250	22	238	800	52
245		233	785	51
243	21	231	780	50
240		228	770	50
235		223	755	49
230		219	740	48
225		214	720	47
220		209	705	46
215		204	690	45
210		199	675	44
205		195	660	43
200		190	640	41

Secondo norma ISO 18265:2003 per gli acciai (ad esclusione degli acciai rapidi)

According to ISO 18265:2003 for steels (except high speed steels) - Selon la norme ISO 18265:2003 pour les aciers (sauf les aciers rapides)

GRUPPI MATERIALE

MATERIAL GROUPS

GROUPES DE MATÉRIAUX

1 Acciaio

Steel - Aciers

268 ÷ 269 ▶

Acciaio legato – Alta resistenza e Temprato

Alloyed steel – high strength steel an hardened steel / Aciers allié - haute résistance - acier trempé

269 ÷ 270 ▶

2 Acciaio INOX

Stainless Steel

270 ÷ 271 ▶

3 Ghisa

Cast Iron

272 ▶

4 Alluminio, Magnesio

Aluminum, Magnesium - Aluminium, magnésium

273 ÷ 274 ▶

5 Rame

Cooper - Cuivre

274 ÷ 275 ▶

6 Titanio

Titanium - Titane

275 ▶

7 Nichel

Nickel

275 ÷ 276 ▶

8 Materie plastiche

Synthetic materials - Plastiques

276 ▶

9 Materiali Speciali

Special Materials - Matériaux spéciaux

277 ▶

10 Grafite

Graphite

277 ▶

1		Acciaio - Steel - Acier		
1.1		Acciaio dolce magnetico Rm < 400 N/mm², < 120 HB		
		<i>Magnetic soft steel - Acier doux magnétique</i>		
	W-Nr.	DIN - Germany	UNI - Italy	
	1.1013	RFe100	-	
	1.1014	Rfe80	-	
	1.1015	Rfe60	-	
1.2		Acciaio da costruzione, da cementazione, automatico Rm < 700 N/mm², < 200 HB		
		<i>Structural steel, case carburizing steel, free cutting steel - Acier de construction, en acier trempé</i>		
	W-Nr.	DIN - Germany	UNI - Italy	
Acciaio da costruzione <i>Structural steel</i> <i>Acier de construction</i>	1.0037	St37-2	Fe360B	
	1.0044	St44-2	Fe430B	
	1.0050	St50-2	Fe490	
	1.0060	St60-2	Fe590	
	1.0070	St70-2	Fe690	
	1.0570	St52-3	Fe510B, C, D	
Acciaio da cementazione <i>Case carburizing steel</i> <i>Acier trempé</i>	1.0301	C10	C10	
	1.0401	C15	C15	
	1.0402	C22	C20, C21	
	1.0406	C25	C25	
	1.7131	16MnCr5	16MnCr5	
	1.7147	20MnCr5	20MnCr5	
	1.5919	15CrNi6	16CrNi4	
	1.6523	21NiCrMo2	20NiCrMo2	
Acciaio automatico (AVP) <i>Free cutting steel</i> <i>Acier automatique</i>	1.0711	9S20	CF10S20	
	1.0715	9SMn28	CF9SMn28	
	1.0718	9SMnPb28	CF9SMnPb28	
	1.0726	35S20	CF35SMn10	
	1.0736	9SMn36	CF9SMn36	
	1.0737	9SMnPb36	CF9SMnPb36	
1.3		Acciaio al carbonio Rm < 850 N/mm², < 250 HB		
		<i>Plain carbon steel - Acier au carbone</i>		
	W-Nr.	DIN - Germany	UNI - Italy	
Da bonifica <i>Heat-treatable steel</i> <i>De revenu</i>	1.0528	C30	-	
	1.0501	C35	C35	
	1.0511	C40	C40	
	1.0503	C45	C45	
	1.0540	C50	-	
	1.0535	C55	C55	
	1.0601	C60	C60	
	1.1178	Ck30	-	
	1.1181	Ck35	C35	
	1.1191	Ck45	C46	

Continua Acciaio al carbonio / Continue Plain carbon steel / Acier au carbone à suivre

	W-Nr.	DIN - Germany	UNI - Italy
Per molle <i>Spring steel</i> <i>Pour les ressorts</i>	1.1231	Ck67	C70
	1.1248	Ck75	C75
	1.1269	Ck85	C85
	1.1274	Ck101	C100
Da tempra superficiale <i>Surface hardening</i> <i>De durcissement de surface</i>	1.1183	Cf35	C36, C38
	1.1193	Cf45	C43
	1.1213	Cf53	C53
Acciaio legato <i>Alloyed steel - Acier allié</i>	1.4	Acciaio legato - bonificato, fusioni d'acciaio Rm < 850 N/mm², < 250 HB <i>Alloyed steel, tempered steel, steel castings - Acier allié, trempé et revenu, fusion d'acier</i>	
	1.5	Acciaio legato - bonificato Rm 850 ÷ 1200 N/mm², 250 ÷ 350 HB <i>Alloyed steel, tempered steel - Acier allié, trempé et revenu</i>	
	1.6	Acciaio legato - alta resistenza Rm 1200 ÷ 1400 N/mm², 38 ÷ 45 HRC <i>Alloyed steel, high strength steel - Acier allié - haute résistance</i>	
	1.7	Acciaio legato - alta resistenza Rm 1400 ÷ 1600 N/mm², 45 ÷ 49 HRC <i>Alloyed steel, high strength steel - Acier allié - haute résistance</i>	
	1.8	Acciaio legato - temprato 49 ÷ 62 HRC <i>Hardened steel - Acier trempé</i>	
Da bonifica <i>Heat-treatable steel</i> <i>De revenu</i>	1.7035	41Cr4	41Cr4
	1.8159	50CrV4, 51CrV4	51CrV4
	1.7218	25CrMo4	25CrMo4
	1.7220	34CrMo4	35CrMo4
	1.7225	42CrMo4	42CrMo4
	1.7228	50CrMo4	-
	1.7242	16CrMo4	18CrMo4
	1.6580	30CrNiMo8	30NiCrMo8
	1.6582	34CrNiMo6	35NiCrMo6 (KW)
	1.6511	36CrNiMo4	38NiCrMo4 (KB)
	1.6773	36NiCrMo16	34NiCrMo16
	1.6565	40NiCrMo6	-
Da nitrurazione <i>Nitriding steel</i> <i>De nituration</i>	1.8515	31CrMo12	31CrMo12
	1.8519	31CrMoV9	-
	1.8507	34CrAlMo7	34CrAlMo7
	1.8509	41CrAlMo7	41CrAlMo7
Da cuscinetti <i>Ball bearing steel</i> <i>Roulements</i>	1.3505	100Cr6	100Cr6
	1.3537	100CrMo7	100CrMo7
Per molle <i>Spring steel</i> <i>Ressorts</i>	1.5025	51Si7	48Si7
	1.5026	56Si7	55Si7
	1.5027	60Si7	-
	1.7108	60SiCr7	60SiCr8
	1.8159	50CrV4	50CrV4
	1.7176	55Cr3	55Cr3
	1.7701	51CrMoV4	-
Fusioni d'acciaio (ghisa acciaiata) <i>Steel castings</i> <i>Acier coulé</i>	1.0446	GS-45	-
	1.0552	GS-52	-
	1.5919	GS-15CrNi6	-
	1.7218	GS-25CrMo4	-
	1.7220	GS-34CrMo4	-
	1.7379	GS-18CrMo9-10	-

Continua Acciaio legato / Continue Alloyed steel / Acier allié à suivre

	W-Nr.	DIN - Germany	UNI - Italy
Per tempra superficiale <i>Surface hardening</i> <i>De durcissement de surface</i>	1.7005	45Cr2	-
	1.7006	46Cr2	46Cr2
	1.7043	38Cr4	-
	1.7034	37Cr4	36CrMn4
	1.7223	41CrMo4	41CrMo4
Per lavorazioni a caldo <i>Hot work tool steel</i> <i>Travail à chaud</i>	1.2767	45NiCrMo16	42NiCrMo 15 7
	1.2713	55NiCrMoV6	-
	1.2714	55NiCrMoV7	55NiCrMoV7KU
	1.2311	40CrMnMo7	35CrMo8KU
	1.2365	X32CrMoV3-3	30CrMoV12-27KU
	1.2343	X38CrMoV5-1	X37CrMoV5-1KU
	1.2344	X40CrMoV5-1	X40CrMoV5-1-1KU
	1.2567	X30WCrV5-3	X30WCrV5-3KU
	1.2581	X30WCrV9-3	X30WCrV9-3KU
Per lavorazioni a freddo <i>Cold work tool steel</i> <i>Travail à froid</i>	1.2080	X210Cr12	X205Cr12KU
	1.2083	X42Cr13	-
	1.2363	X100CrMoV5-1	X100CrMoV5-1KU
	1.2379	X155CrVMo12-1	X155CrVMo12-1KU
	1.2510	100MnCrW4	95MnWCr5KU
	1.2550	60WCrV7	55WCrV8KU
	1.2842	90MnCrV8	90MnVCr8KU
Acciaio rapido HSS, HSS-E <i>High speed steel</i> <i>Acier rapide</i>	1.3202	S 12-1-4-5	(T15)
	1.3207	S 10-4-3-10	HS 10-4-3-10 (T42)
	1.3243	S 6-5-2-5	HS 6-5-2-5 (M35)
	1.3247	S 2-10-1-8	HS 2-9-1-8 (M42)
	1.3343	S 6-5-2	HS 6-5-2 (M2)
	1.3344	S 6-5-3	(M3/2)
	1.3348	S 2-9-2	HS 2-9-2 (M7)
Acciaio rapido sinterizzato HSS-PM <i>Sintered high speed steel</i> <i>Acier fritté</i>	-	HS 6-5-3-8	(ASP2030, ASP30)
	-	HS 10-2-5-8	(ASP2052, ASP52)
	-	HS 6-7-6-10	(ASP2060, ASP60)
1.7 Acciaio speciale Rm<1600 N/mm² <i>Special steel</i> <i>Acier spécial</i>			HARDOX 400
1.8 Acciaio speciale 49 – 62 HRC <i>Special steel</i> <i>Acier spécial</i>			HARDOX 450
			HARDOX 500
			HARDOX 600
2	Acciaio INOX - Stainless Steel - Acier inoxydable		
2.1	Acciaio INOX automatico Rm < 850 N/mm², < 250 HB		
	<i>Free machining stainless steel - Automatique acier inoxydable</i>		
	W-Nr.	DIN - Germany	UNI - Italy
1.4104	X14CrMoS17	X10CrS17 (AISI 430F)	
1.4305	X8CrNiS18-9	X10CrNiS18-9 (AISI 303)	

Continua Acciaio INOX / Continue Stainless Steel / Acier inoxydable à suivre

2.2			
Austenitico Rm < 850 N/mm², < 250 HB			
<i>Austenitic stainless steel - Austénitique</i>			
	W-Nr.	DIN - Germany	UNI - Italy
	1.4301	X5CrNi18-10	X5CrNi18-10 (AISI 304)
	1.4306	X2CrNi19-11	X2CrNi18-11 (AISI 304L)
	1.4401	X5CrNiMo18-10	X5CrNiMo17-12 (AISI 316)
	1.4404	X2CrNiMo17-13-2	X2CrNiMo17-12 (AISI 316L)
	1.4406	X2CrNiMoN17-12-2	X2CrNiMoN17-12 (AISI 316LN)
	1.4435	X2CrNiMo18-14-3	X2CrNiMo17-13
	1.4438	X2CrNiMo18-16-4	X2CrNiMo18-15 (AISI 317L)
	1.4541	X6CrNiTi18-10	X6CrNiTi18-11 (AISI 321)
	1.4550	X6CrNiNb18-10	X8CrNiNb18-11 (AISI 347)
	1.4828	X15CrNiSi20-12	X16CrNi23-14
	1.4841	X15CrNiSi25-20	X16CrNiSi25-20 (AISI 314)
	1.4845	X12CrNi25-21	X6CrNi25-20 (AISI 310S)
2.3			
Ferritico, Ferritico + Austenitico, Martensitico Rm < 1100 N/mm², < 320 HB			
<i>Ferritic, ferritic + austenitic, martensitic - Ferritique, ferritique + austénitique, martensitique</i>			
	W-Nr.	DIN - Germany	UNI - Italy
Ferritico <i>Ferritic</i> <i>Ferritique</i>	1.4002	X6CrAl13	X6CrAl13 (AISI 405)
	1.4003	X2Cr11	X2CrNi12
	1.4016	X6Cr17	X8Cr17 (AISI 430)
	1.4510	X6CrTi17	X6CrTi17 (AISI 430Ti)
	1.4509	X2CrTiNb18	X2CrTiNb18
	1.4512	X5CrTi12	X6CrTi12 (AISI 409)
Ferritico + austenitico (Bifasico) <i>Ferritic + austenitic (Duplex)</i> <i>Ferritique+austénitique, (biphasique)</i>	1.4462	X2CrNiMoN22-5-3	X2CrNiMoN22-5-3
	1.4501	X2CrNiMoCuWN25-7-4	X2CrNiMoCuWN25-7-4
Martensitico <i>Martensitic</i> <i>Martensitique</i>	1.4006	X10Cr13	X12Cr13 (AISI 410)
	1.4005	X12CrS13	X12CrS13 (AISI 416)
	1.4021	X20Cr13	X20Cr13 (AISI 420)
	1.4028	X30Cr13	X30Cr13
	1.4057	X17CrNi16-2	X16CrNi16 (AISI 431)
	1.4125	X105CrMo17	(AISI 440C)
2.4			
Leghe Cr-Ni resistenti alle alte temperature Rm 1100 ÷ 1400 N/mm², 330 ÷ 410 HB			
<i>Cr-Ni alloys high temperatures resistant - Alliages Cr-Ni résistant à des températures élevées</i>			
	W-Nr.	DIN - Germany	UNI - Italy
Indurente per precipitazione <i>Precipitation hardening</i> <i>Durcissement par précipitation</i>	1.4542	X5CrNiCuNb16-4	(AISI 630, 17-4 PH)
	1.4545	X4CrNiCu16-6	(15-5 PH)
	1.4568	X7CrNiAl17-7	(17-7 PH)
	1.4922	X20CrMoV11-1	-
	1.4939	X12CrNiMo12	-
	1.4944	-	(AISI 660)
	1.4980	X6NiCrTiMoVB25-15-2	

3	Ghisa - Cast Iron - Fonte		
3.1	Ghisa grigia lamellare Rm < 600 N/mm², < 180 HB		
	<i>Lamellar grey cast iron - Fonte grise lamellaire</i>		
	W-Nr.	DIN - Germany	UNI - Italy
	0.6010	GG-10	G 10
	0.6015	GG-15	G 15
	0.6020	GG-20	G 20
3.2	Ghisa grigia lamellare Rm 600 ÷ 1000 N/mm², 180 ÷ 300 HB		
	<i>Lamellar grey cast iron - Fonte grise lamellaire</i>		
	W-Nr.	DIN - Germany	UNI - Italy
	0.6025	GG-25	G 25
	0.6030	GG-30	G 30
	0.6035	GG-35	G 35
	0.6040	GG-40	G 40
3.3	Ghisa sferoidale Rm < 1000 N/mm², < 300 HB		
	<i>Nodular cast iron - Fonte ductile</i>		
	W-Nr.	DIN - Germany	UNI - Italy
	0.7033	GGG-35.3	-
	0.7040	GGG-40	GS400-12
	0.7043	GGG-40.3	GSO 42/17
	0.7050	GGG-50	GS500-7
	0.7060	GGG-60	GS600-3
	0.7070	GGG-70	GS700-2
	0.7080	GGG-80	GS800-2
	0.7670	GGG-Ni22	-
	0.7683	GGG-Ni35	-
	0.7660	GGG-NiCr20-2	-
	0.7677	GGG-NiCr30-1	-
0.7685	GGG-NiCr35-3	-	
3.4	Ghisa malleabile Rm < 700 N/mm², < 210 HB		
	<i>Malleable cast iron - Fonte malléable</i>		
	W-Nr.	DIN - Germany	UNI - Italy
	0.8035	GTW-35-04	-
	0.8045	GTW-45-07	-
	0.8145	GTS-45-06	-
	0.8165	GTS-65-02	-
	0.8170	GTS-70-02	-
3.5	Ghisa vermicolare a grafite compatta Rm 700 ÷ 1000 N/mm², 200 ÷ 300 HB		
	<i>Compacted cast iron with vermicular graphite - Fonte vermiculaire à graphite compacté</i>		
	W-Nr.	DIN - Germany	Denom. comm./Trade name/Nom comm.
			(CGI)
		(GGV)	
		(GJV)	

4	Alluminio, Magnesio - Aluminium, Magnesium - Alliage, Magnésium		
4.1	Alluminio / Magnesio non legato Rm < 350 N/mm², < 100 HB		
	<i>Aluminium / Magnesium unalloyed - Aluminium / Magnésium non allié</i>		
	W-Nr.	DIN - Germany	UNI - Italy
	3.0205	Al99	3567 (9001/1)
	3.0255	Al99.5	4507 (9001/2)
	3.0285	Al99.8	4509 (9001/4)
	3.0305	Al99.9	-
	3.3208	Al99.9MgSi	-
	3.3308	Al99.9Mg0.5	-
	3.3318	Al99.9Mg1	-
4.2	Leghe di Al, Si < 0,5% - truciolo lungo Rm < 500 N/mm², < 150 HB		
	<i>Al alloys, long chipping - Alliage, coupeaux longs</i>		
	W-Nr.	DIN - Germany	UNI - Italy
	3.0505	AlMn0.5Mg0.5	(AISI 3105)
	3.0915	AlFeSi	(AISI 8011A)
	3.3315	AlMg1	5764 (5005, Peraluman100)
	3.3525	AlMg2Mn0.3	(AISI 5251)
	3.3527	AlMg2Mn0.8	(AISI 5049)
	3.3545	AlMg4Mn	(AISI 5086)
	3.3555	AlMg5	(AISI 5056A)
	3.0615	AlMgSiPb	(AISI 6012)
	3.1255	AlCuSiMn	3581 (AISI2014)
	3.1325	AlCuMg1	3579 (AISI 2017A, Avional 100)
	3.1355	AlCuMg2	3583 (AISI 2024, Avional 150)
	3.3547	AlMg4.5Mn	7790 (AISI 5083, Peraluman 460)
	3.3206	AlMgSi0.5	3569 (AISI 6060, Anticorodal 050)
	3.2315	AlMgSi1	3571 (AISI 6082, Anticorodal 110)
	3.4365	AlZnMgCu1.5	3735 (AISI 7075, Ergal 55)
	3.1371	G-AlCu4TiMg	-
	3.3241	G-AlMg3Si	-
	3.3261	G-AlMg5Si	-
	3.3541	G-AlMg3	-
4.3	Leghe di Al, Si < 10% - truciolo medio Rm < 500 N/mm², < 150 HB		
	<i>Al alloys, medium chipping - Alliage Al - coupeaux moyen</i>		
	W-Nr.	DIN - Germany	UNI - Italy
	3.2134	G-AlSi5Cu1Mg	3600
	3.2161	G-AlSi8Cu3	5075
	3.2162.05	GD-AlSi8Cu3	-
	3.2371	G-AlSi7Mg	7257
	3.2373	G-AlSi9Mg	3051
4.4	Leghe Al, Si > 10% - truciolo corto Rm < 600 N/mm², < 180HB		
	<i>Al alloys, short chipping - Alliage Al - coupeaux courts</i>		
	W-Nr.	DIN - Germany	UNI - Italy
	3.2381	G-AlSi10Mg	3049
	3.2383	G-AlSi10Mg(Cu)	-
	3.2581	G-AlSi12	5079
	3.2583	G-AlSi12(Cu)	3048

Continua leghe di Magnesio / Continue Magnesium alloys / Alliages de Magnésium à suivre

4.5	Leghe standard di magnesio Rm 120 ÷ 300 N/mm²				
	<i>Magnesium standard alloys - Alliages de magnésium standards</i>				
	W-Nr.	DIN - Germany	Denom. comm./Trade name/Nom comm.		
	3.5200	MgMn2	(MAGNUMINIUM 133)		
	3.5312	MgAl3Zn	(AZ31)		
	3.5632	MgAl6Zu3	(AZ63)		
	3.5812	MgAl8Zn1	(AZ81 hp)		
	3.5912	MgAl9Zn1	(AZ91 hp)		
	Leghe di magnesio ad alta resistenza Rm 240 ÷ 400 N/mm², 70 ÷ 120 HB				
	<i>High strength magnesium alloys - Alliages de magnésium de haute résistance</i>				
4.6	3.5161	MgZn6Zr	(ZK60)		
	3.5612	MgAl6Zn1	(AZ61)		
5 RAME - Cooper - Cuivre					
5.1	Rame puro, rame elettrolitico - truciolo lungo Rm < 350 N/mm², < 100 HB				
	<i>Cooper unalloyed, long chipping - Cuivre pur, cuivre électrolytique, coupeaux longs</i>				
	W-Nr.	DIN - Germany	Denom. comm./Trade name/Nom comm.		
	2.0040	OF-Cu	-		
	2.0060	E-Cu57	-		
	2.0065	E-Cu58	-		
	2.0070	Se-Cu	-		
5.2	2.0076	SW-Cu	-		
	2.0090	SF-Cu	-		
	Leghe di rame, α ottone - truciolo lungo Rm < 700 N/mm², < 200 HB				
	<i>Cooper alloys, soft brass, long chipping - Alliages de cuivre, laiton, coupeaux longs</i>				
	W-Nr.	DIN - Germany	Denom. comm./Trade name/Nom comm.		
	2.0240	CuZn15, Ms85	-		
	2.0250	CuZn20, Ms80	-		
Ottone / Brass / Laiton	2.0265	CuZn30, Ms70	-		
	2.0280	CuZn33, Ms67	-		
	2.0321	CuZn37, Ms63	-		
	Bronzo / Bronze	2.0335	CuZn36, Ms64	-	
		2.1016	CuSn4	-	
2.1020		CuSn6	-		
2.1030		CuSn8	-		
2.1080	CuSn6Zn6	-			
5.3	Leghe di rame, β ottone, bronzo - truciolo corto Rm < 700 N/mm², < 200 HB				
	<i>Cooper alloys, hard brass, bronze, short chipping - Alliages de cuivre, laiton, bronze, coupeaux courts</i>				
	W-Nr.	DIN - Germany	Denom. comm./Trade name/Nom comm.		
	2.0360	CuZn40 (Ms60)	-		
	2.0380	CuZn39Pb2 (Ms58)	-		
	2.0410	CuZn44Pb2 (Ms56)	-		
	Ottone / Brass / Laiton	2.0510	CuZn37Al1	-	
		2.0550	CuZn40Al2	-	
		2.0561	CuZn40Al1	-	
		2.0580	CuZn40Mn1Pb	-	
		Bronzo / Bronze	2.2140	G-ZnAl4	(ZAMAK)
			2.1086	G-CuSn10Zn	-
			2.1093	G-CuSn6ZnNi	-
2.1096	G-CuSn5ZnPb		-		

Continua Bronzo / Continue Bronze / Bronze à suivre

5.4	Bronzo ad alta resistenza Rm < 1500 N/mm², < 440 HB		
	<i>High strength bronze - Bronze haute résistance</i>		
	W-Nr.	DIN - Germany	Denom. comm./Trade name/Nom comm.
	2.0932	CuAl8Fe3	(Ampco12)
	2.0936	CuAl10Fe3Mn2	(Ampco16, Ampco 15)
	2.0940	CuAl10Fe	-
	2.0966	CuAl10Ni5Fe4	(Ampco)
	2.0978	CuAl11Ni6Fe5	-
6	Titanio - Titanium - Titane		
	Titanio non legato Rm < 700 N/mm², < 200 HB		
	<i>Titanium unalloyed - Titane non allié</i>		
	W-Nr.	DIN - Germany	Altro / Other / Autres
	3.7024	Ti99.8	T35, Grade 1
	3.7034	Ti99.7	T40, Grade 2
	3.7055	Ti99.6	T50, Grade 3
	3.7064	Ti99.5	T60, Grade 4
6.2	Leghe di titanio Rm < 900 N/mm², < 270 HB		
	<i>Titanium alloys - Alliages de titane</i>		
6.3	Leghe di titanio Rm < 1400 N/mm², < 410 HB		
	<i>Titanium alloys - Alliages de titane</i>		
	W-Nr.	DIN - Germany	Altro / Other / Autres
	3.7124	TiCu2	-
	3.7154	TiAl6Zr5	-
	3.7164, 3.7165	TiAl6V4	Grade 5
7	Nichel - Nickel - Nickel		
	Nichel non legato Rm < 500 N/mm², < 150 HB		
	<i>Nickel unalloyed - Nickel non allié</i>		
	W-Nr.	DIN - Germany	Denom. comm./Trade name/Nom comm.
	1.3911	Rni24	-
	1.3926	Rni12	-
	1.3927	Rni8	-
	2.4061	Ni99,6	Nickel 205
2.4066	Ni99,2	Nickel 200	
7.2	Leghe di Nichel Rm < 900 N/mm², < 270 HB		
	<i>Nickel alloys - Alliages de Nickel</i>		
7.3	Leghe di Nichel Rm < 1600 N/mm², < 470 HB		
	<i>Nickel alloys - Alliages de Nickel</i>		
	W-Nr.	DIN - Germany	Denom. comm./Trade name/Nom comm.
	1.3912	X2Ni36	Invar
2.4360	NiCu30Fe	Monel 400	
2.4375	NiCu30Al	Monel K500	

Continua leghe Nichel / Continue Nickel alloys / Alliages de Nickel à suivre

7.2 – 7.3	W-Nr.	DIN - Germany	Denom. comm./Trade name/Nom comm.
	2.4602	NiCr17Mo17FeW	Hastelloy C
	2.4630	Ni-Cr20Ti	Nimonic 75
	2.4631	NiCr20TiAl	Nimonic 80A
	2.4634	NiCo20Cr15MoAlTi	Nimonic 105
	2.4636	NiCo15Cr15MoAlTi	Udimet 700
	2.4654	NiCr20Co14MoTi	Waspaloy
	2.4662	NiCr13Mo6Ti3	Nimonic 901
	2.4665	NiCr22Fe18Mo	Hastelloy X
	2.4668	NiCr19Fe19NbMo	Inconel 718
	2.4670	G-NiCr13Al6MoNb	Nimocast 713
	2.4674	NiCo15Cr10MoAlTi	Nimocast PK24
	2.4816	NiCr15Fe	Inconel 600
	2.4856	NiCr22Mo9Nb	Inconel 625
8	Materie plastiche - <i>Synthetic materials - Matériaux de plastique</i>		
8.1	Materiali termoplastici - truciolo extralungo Rm < 80 N/mm² <i>Thermoplastics, extra long chipping - Matériaux thermoplastique, coupeaux extra-longue</i>		
	W-Nr.	DIN - Germany	Denom. comm./Trade name/Nom comm.
	-	-	ABS
	PE	Polyethylene	Hostalen
	PP	Polypropylene	Hostalen PP
	PVC	Polyvinyl chloride	Hostalit, Vestolit, Vinoflex
	PS	Polystyrene	Polystyrol
	PMMA	Polymethyle acryle	Plexiglas
	PTFE	Polytetrafluorethylene	Teflon
	PA	Polyamide	Nylon, Ultramid
	PC	Polycarbonate	Makralon
	PI	Thermoplastic polyamide	Kinel
8.2	Materiali termoindurenti - truciolo corto Rm < 110 N/mm² <i>Thermosetting plastics, short chipping - Matériaux thermodurcissables, coupeaux courts</i>		
	W-Nr.	DIN - Germany	Denom. comm./Trade name/Nom comm.
	PF	Phenol formaldehyde	Pertinax
	MF	Melamine formaldehyde	Albanit, Resopal
	UF	Urea formaldehyde	Bakelite
8.3	Materie plastiche con fibre di rinforzo Rm 800 ÷ 1500 N/mm², 240 ÷ 440 HB <i>Reinforced plastic materials - Plastiques avec fibres de renfort</i>		
	W-Nr.	DIN - Germany	Denom. comm./Trade name/Nom comm.
	AFK	Aramid	Kevlar
	BFK	Boron	Boro
	CFK	Carbon fibre	Resine + Fibra di carbonio
	GFK	Glass fibre	Resine + fibre di vetro
	SFK	Synthetic fibre	Resine + fibre sintetiche

9	Materiali Speciali - <i>Special Materials - Matériaux spéciaux</i>		
9.1	Materiali metallo – ceramici (Cermets) Rm < 1700 N/mm², < 51 HRC <i>TIC - Hard materials - Matériaux métalliques, céramiques (Cermet)</i>		
	W-Nr.	DIN - Germany	Denom. comm./Trade name/Nom comm.
			Ferritan
			Ferro Titanit
			Ferrotic
9.2	Leghe a base Cobalto Rm < 1200 N/mm², < 350 HB <i>Alloys on cobalt base - Alliages à base de cobalt</i>		
	W-Nr.	DIN - Germany	Denom. comm./Trade name/Nom comm.
			AiResist
			Biodur
			Celsit
			Haynes Alloy
			Stellite
9.3	Leghe di tungsteno Rm < 1800 N/mm², < 52 HRC <i>Tungsten alloys - Alliages de tungstène</i>		
	W-Nr.	DIN - Germany	Denom. comm./Trade name/Nom comm.
			Anviloy
			Denal
			Densimet
			Mallory
10	Grafite - <i>Graphite</i>		
10.1	Grafite Rm < 100 N/mm² <i>Graphite</i>		
	W-Nr.	DIN - Germany	Denom. comm./Trade name/Nom comm.
			Graphit R8340
			Technograph 15
			Technograph 30
			R8510
			R8650
			Union Poco EDM1
			Union Poco EDM3

CONDIZIONI GENERALI DI VENDITA

SALES GENERAL CONDITIONS

CONDITIONS GÉNÉRALES DE VENTE

Accettazione dell'ordine - Acceptance of the order - Prise en compte de la commande

Sono considerati ordini validi solo quelli scritti. In caso di ordine telefonico dovrà seguire pertanto la conferma scritta.

Only written orders are considered as valid. Telephone orders must be confirmed in writing.

Sont considérés comme ordres valides, les commandes suivies d'une confirmation écrite.

Idem pour les commandes Commande téléphoniques.

Consegna - Delivery - Livraison

Gli ordini verranno evasi dal nostro magazzino in Sparone (TO) in base alla disponibilità dello stesso. I termini di consegna da noi indicati nelle offerte si intendono validi, salvo imprevisti.

The orders will be sent from our store in Sparone (TO) depending on the availability of the goods.

Our delivery terms shown in the offers are intended as valid, circumstances permitting.

Les commandes seront expédiées depuis notre entrepôt de Sparone (TO), sous réserve de disponibilité des produits.

Les délais de livraison indiqués dans nos offres sont exacts, sauf « circonstances imprévues ».

Spedizione - Shipment - Expédition

La merce viaggia sempre a rischio e pericolo del committente, anche in caso di merce franco destino. Saranno utilizzati i corrieri celeri, giornalieri, ad esclusione del servizio postale, se non richiesto espressamente dal cliente. In tal caso il rischio di mancato recapito, o di mancata rintracciabilità della merce sarà di esclusiva competenza del cliente. I prodotti sono confezionati in contenitori in P.P. singoli o multipli, atti a preservare l'integrità degli utensili durante il trasporto.

The goods always travels at the buyer's risk, also in the case of goods free at destination. Fast couriers are used which deliver on the same day as ordered, not using the postal service, unless expressly requested by the customer. If the goods do not arrive, or if the goods cannot be traced, it will be the exclusive responsibility of the customer and the goods are shipped after payment. The products are packaged in single or multiple P.P containers, to preserve the integrity of the tools during transport.

Les marchandises voyagent toujours aux risques et périls du client, même en cas de marchandise franco de port. Nous utilisons les transports rapides, tous les jours, à l'exclusion de la poste, sauf demande du client. Dans ce cas, le risque de défaut de livraison ou non-traçabilité des marchandises sont sous la seule responsabilité du client. Les produits sont conditionnés dans un emballage en P.P. simples ou multiples, afin de préserver l'intégrité des outils pendant le transport.

La riproduzione anche parziale di testi ed immagini sono permessi solo dopo esplicita richiesta e previa approvazione scritta da parte della UFS srl. La stessa si riserva pertanto di perseguire penalmente gli autori di pubblicazioni non autorizzate o non fedeli a quanto in originale.

Reproduction, including partial reproduction of texts and images, is permitted only after explicit request and upon written approval from UFS srl. The same reserves the right to prosecute the authors of unauthorised publications or those which are unfaithful to the original.

Reproduction même partielle des textes et images n'est autorisées qu'après demande express et préalable approuvé par la direction d'UFS. Nous nous réservons le droit de poursuite en justice les auteurs de publications non autorisées ou pour le non respect de l'original.

Le informazioni e le caratteristiche tecniche possono essere soggette a variazioni senza preavviso.

I dati tecnici ivi contenuti sono da considerarsi salvo errori e/o omissioni.

Immagini e testi possono quindi subire variazioni rispetto a quanto riportato sul presente catalogo.

Sarà premura della UFS srl segnalare le modifiche sul sito web www.ufs.it che si consiglia di consultare come riferimento principale per l'aggiornamento dei dati.

The information and technical characteristics can be subject to variations without prior notice.

The technical data contained herein are to be considered, errors and omissions excepted. Images and texts can therefore be subject to variations compared to what is present on the catalogue.

UFS srl shall indicate the changes on its website www.ufs.it as soon as possible.

It is advisable to consult the website as main reference for the updating of data.

Les informations et les spécifications sont sujettes à modification sans préavis. Les données techniques qui y figurent sont sous réserve d'erreurs ou d'omissions.

Images et textes peuvent alors varier de celles indiquées sur le présent catalogue.

UFS srl rendra compte des changements via le site web www.ufs.it, qui est la principale référence de mise à jour des données.

QUESTIONARIO TECNICO

Maschiatura ad asportazione e rullatura

Compilatore:

Data:

Prot:

 Campionatura / Quantità: _ _ _ _ _

 Ordine / Quantità: _ _ _ _ _

 Reclamo

Cliente:

Tel:

Fax:

Persona di rif:

e-mail:

1. Filettatura

 \emptyset x Passo

Toll.

Norma:

Descrizione

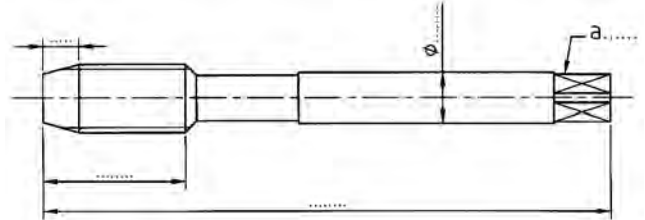

2. Particolare da lavorare:

Materiale:

Sigla:

 resistenza N/mm²

 Durezza: HB
 HRC

 Truciolo: corto medio lungo

Caratteristiche particolari del materiale:

 \emptyset preforo

ottenuto per...

Foratura Prefuso
 Prestampato Tornitura

Alesatura: SI NO

Foro passante

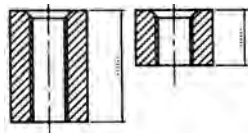

....x D

Foro cieco

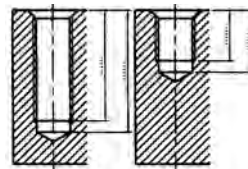

....x D

Foro cieco/passante

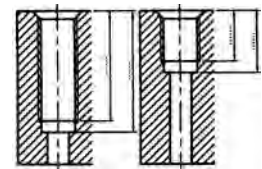

....x D

3. Macchina marca e tipo:

 Verticale Obliqua
 Orizzontale Altro

Avanzamento Patrona Manuale

 Idraulico Meccanico

 CNC Andata Ritorno

%Prog. avanzamento assiale

Parametri di taglio	Andata	Ritorno
	Vc (m/min)	
N°giri (1/min)		

3.1. Mandrino (marca):

 N° mandrini Adduzione interna
 _ _ _ _

Maschiatura rigida:

 In pinza Calettamento
 Micro - compensazione Weldon
 Altro:

Maschiatura compensata:

 Compensazione assiale in rientro e sfilamento Solo sfilamento
 Altro:

4. Lubrificante:

 Emulsione
 % _ _ _ _ _

 Olio intero Lubrificazione
 Minimale (MMS) Aria

5. Problematica:

6. Dati concorrenza:

Rivestimento:

Resa:

TECHNICAL FORM

Thread cutting and thread forming

Writer:

Date:

N° Prot:

Sampling / Quantity: _ _ _ _ _

Order / Quantity: _ _ _ _ _

Complaint

Customer:

Phone:

Fax:

Reference person:

e-mail:

1. Thread size

Ø x Pitch

Tolerance

Norm:

Description tap

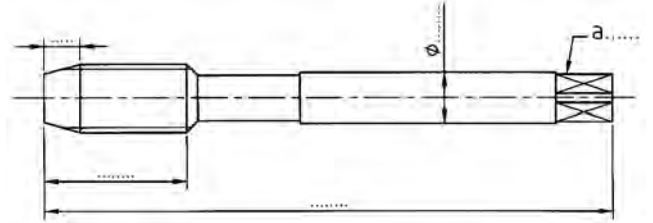

2. Work-Piece:

Material:

Code:

Tensile strength N/mm²

Hardness: HB
 HRC

Chip type: short medium long

Particular characteristic of material:



Ø Core hole

Obtained from...

- Drilling Prefuse
 Molding Turning

Through hole

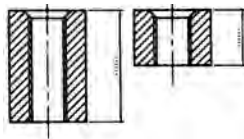

...x D

Blind hole

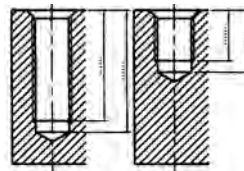

...x D

Blind/through hole

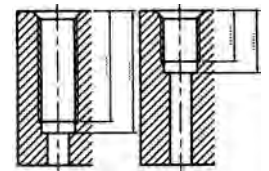

...x D

Boring: YES NOT

3. Machine brand and type:

- Vertical Obliquely
 Horizontal Other

Feed

- Leadscrew Manual
 Hydraulic Mechanic

CNC

%Prog. axial feed

Advance Reverse

Cutting speed

Vc (m/min) Advance Reverse
N°giri (1/min)

3.1. Tool holder (Manufacturer):

N° spindle Internal coolant supply
_ _ _ _

Rigid tapping:

- Collets Fitting
 Micro - compensation Weldon
 Other:

Tapping with compensation:

- With axial compensation in compression and extension
 Extension only
 Other:

4. Coolant (brand):

Emulsion
% _ _ _ _ _

Cutting oil Minimal lubrication To dry
(MMS)

5. Problems:

6. Competitor's characteristics:

Surface treatment:

Tool's life:

QUESTIONNAIRE TECHNIQUE

Taroudage normal ou par déformation

Compilateur :

Date:

Protocole:

 Échantillonnage/quantité: _ _ _ _ _ Commande/ Quantité: _ _ _ _ _ Reclamation

Client:

Tel:

Fax:

référence client:

e-mail:

1. Filetage

Ø x Pass

Tolérance

Norme:

Description

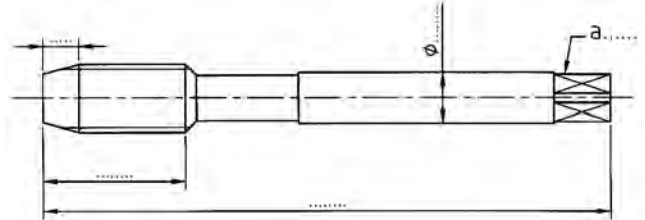

2. Pièce à usiner:

Matériau:

Norme:

Résistance N/mm²Dureté: HB
 HRC

Copeau:

 court moyen long

Particularités de la matière:



Ø preforo

obtenue par...

 Perçage
 Moulage Fusion
 Tournage

Trou débouchant

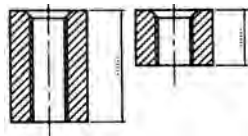

...x D

Trou borgne

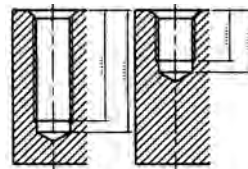

...x D

Trou borgne/débouchant

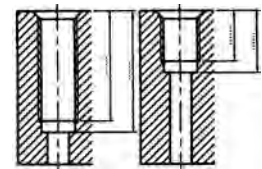

...x D

Alésage:

OUI

NON

3. Machine marque et type:

 Vertical Oblique Horizontal Autres

Avance

 Patronne Manuelle Hydraulique Mécanique CNC

% Prog. avance axiale

Aller

Retour

Paramètres
de coupe

Vc (m/min)

Aller

Retour

N ° tours (1/min)

3.1. Broche (marque):

Type de Mandrin

 lubrification axiale

Taroudage rigide :

 Par pinces Bridage -Fixation Micro-compensation Weldon Autres:

Taroudage compensé :

 Compensation axiale en compression et en extension Seulement en extension Autres:

4. Lubrifiant:

 Émulsion Huile Entiere Lubrification Air

% _ _ _ _ _

Minimale (MMS)

5. Problématique :

6. Données de la concurrence:

Revêtement :

Resa:

Note

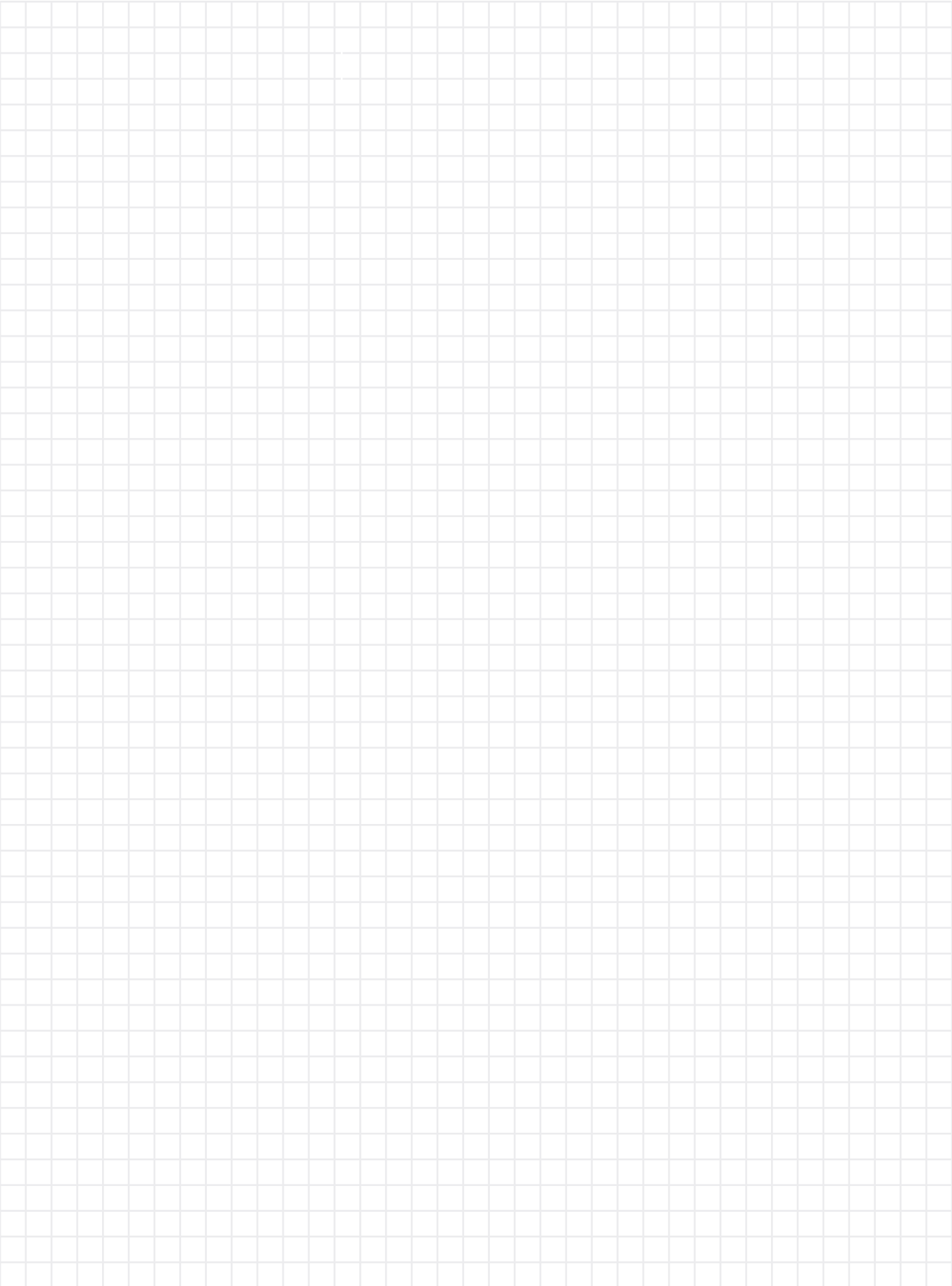

Note





WWW.UFS.IT



UFS - Sparone (TO) - Italy