



LISTINO PREZZI 81

2024

Prezzi I.V.A. esclusa
validi fino al 28.02.2025

BETA È SINONIMO DI
AUDACIA. IMPEGNO. ARMONIA. TALENTO.



WELL DONE. 

In Beta esiste un solo modo di fare le cose: farle bene.

Questo è il mondo di Beta, questo il principio che guida il nostro lavoro quotidiano in tutto il mondo, ispirati da quattro valori:

AUDACIA *di investire e rilanciare costantemente un'impresa creata da un artigiano italiano nel 1923, affermata nel mondo e in continua crescita da quattro generazioni.*

IMPEGNO *nel curare fino al minimo dettaglio la qualità dei nostri prodotti, perché ogni rivenditore sa di poter contare su un servizio efficiente, e ogni utilizzatore sulla precisione, l'affidabilità e la resistenza dei prodotti Beta.*

ARMONIA *delle linee, per un design di eccellenza, perché quando una cosa è fatta bene, esprime un perfetto equilibrio tra funzione e design.*

TALENTO *è la nostra risorsa più preziosa, quella che distingue le nostre persone e tutti coloro che scelgono Beta per non lasciare nulla al caso, nell'appassionante realizzazione delle proprie idee e dei propri sogni.*

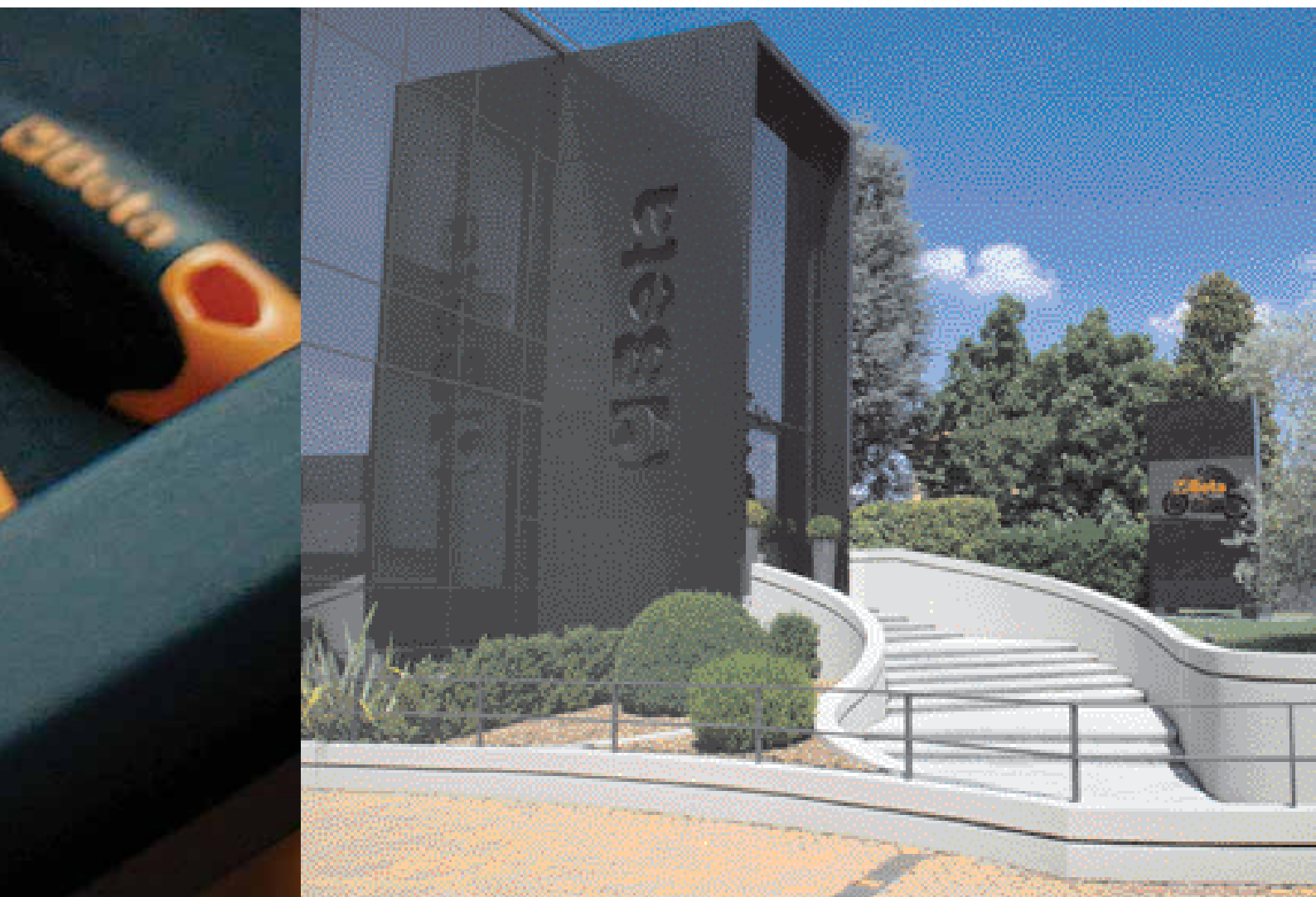

INDICE



	📖
Indice generale	4
Guida alla lettura	8
Campi di impiego chiavi dinamometriche	58-59
Tabella contenitori e assortimenti	351, 479-480
Servizio di taratura dinamometria	727
Articoli eliminati-articoli sostitutivi/consigliati	728÷730
Indice alfabetico	731÷735
Indice alfabetico Autoriparazione	736÷738
Indice alfanumerico	739÷753
Condizioni generali di vendita	754-755
Organizzazione di vendita	756
Il nostro servizio rapido	757
Numeri chiave Gruppo Beta.....	758
La storia dell'utensileria italiana	759
Qualità certificata	760
Controllo e qualità	761
Al servizio dell'industria	762
Logistica	763
Organizzazione del lavoro	764
Presenza competente	765

INDICE GENERALE

ARREDO OFFICINA RSC55



RSC 55

410÷435; 475÷478

ARREDO OFFICINA RSC50



Beta

436÷453; 475÷478

ARREDO OFFICINA C45PRO



Beta
C45PRO

454÷478

CONTENITORI E ASSORTIMENTI



351÷370



371÷400



383; 401÷409



479÷561

CHIAVI DI MANOVRA



11÷17

23÷27

112÷117

CHIAVI A BUSSOLA E ACCESSORI



69÷78

85÷112

CHIAVI DINAMOMETRICHE E MOLTIPLICATORI



54÷56

57÷69

GIRAVITE, CHIAVI MASCHIO E INSERTI



18÷23

78÷85

114÷117

145÷159

PINZE E TRONCHESI



127÷134

139÷142

236

MARTELLI E SCALPELLI



9-10

166÷170

217÷218

ILLUMINAZIONE



242÷247

UTENSILI PER FORARE E FILETTARE



36÷41

41÷43

44÷51

51÷53

AVVOLGITORI



247÷249; 347

ESTRATTORI



171÷172

198÷204

IDRAULICA



27÷35

UTENSILI PER MISURARE E TRACCIARE



210÷217

ELETTRONICA E MICROMECCANICA



126-127

142÷144

148÷151

UTENSILI PER TAGLIARE E MANUTENZIONI VARIE

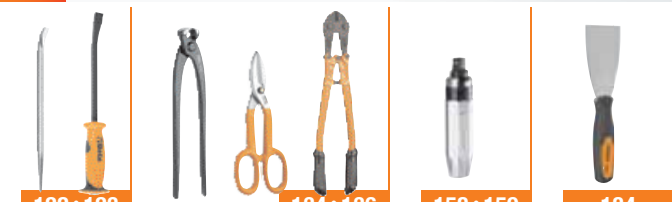

122÷123

134÷136

158÷159

184

ELETTROTECNICA

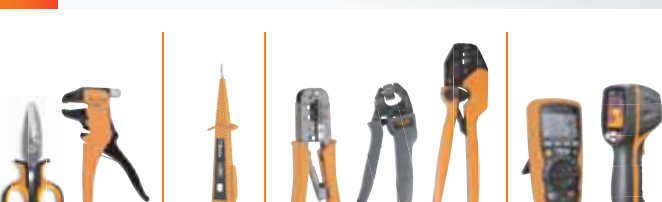

136÷139

150

585÷587

232÷236



209

219÷228

SALDATURA



250÷254



238÷241

325÷326

UTENSILI ISOLATI

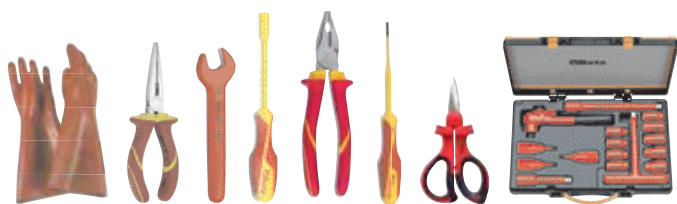

285÷291

UTENSILI INOX



299÷303

UTENSILI ANTISCINTILLA



304÷312

AUTORIPARAZIONE



118÷125

160÷166



170÷198; 204÷208

229÷232

232÷238

ATTREZZATURA DA OFFICINA



254÷273

UTENSILI PER MOTORIPARAZIONE



274÷279

UTENSILI PER BICICLETTA



280÷284

ELETTROUTENSILI



313÷324

UTENSILI PNEUMATICI E ACCESSORI



327÷350

UTENSILI ANTICADUTA



292÷298

PRODOTTI **CHIMICI**



562÷567

CALZATURE DI SICUREZZA (E CALZE TECNICHE)



624÷649

PRODOTTI **ABRASIVI**



568÷584

ABBIGLIAMENTO DA LAVORO



650÷670

PRODOTTI **ELETTRICI**



588÷594

GAMMA BLISTER



595÷609

ACCESSORI PER FUNI **ROBUR**

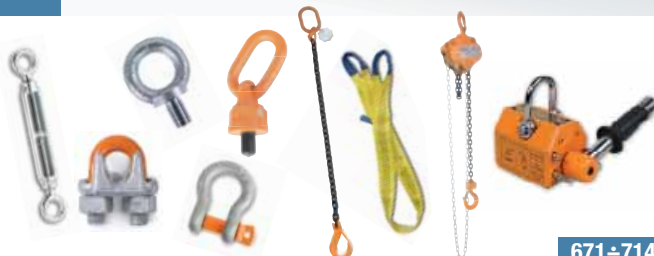

671÷714

SOLUZIONI PER IL **PUNTO VENDITA**



610÷623

BETA COLLECTION



715÷726

GUIDA ALLA LETTURA

numero articolo **951GP**

chiavi a T con una estremità
maschio esagonale con **astina fissa**

La chiave Beta 951GP offre rapidità di manovra e precisione
dell'accoppiamento con la vite.
Concepita per risolvere alcune problematiche del mondo
Racing: sviluppare coppie elevate e compiere serraggi veloci.

profilo utensile 

prezzo unitario

★ articolo fornibile a richiesta
• misura principale
◊ bocca esagonale

misura

**numero utensili
nella confezione**

**numero utensili
nella serie**

tipo confezione

**contenuto
della serie**

numero codice

novità 2024

in confezione blister 

utensili per motoriparazione 



utensili per biciclette 

mm	L mm	L1 mm	Ø mm	€		
3	185	130	5	19,00	3	009511530
4	214	150	5	20,00	3	009511540
5	240	165	6	23,00	3	009511550
6	271	180	7	26,50	3	009511560
8	300	200	10	34,00	3	009511580
10	310	200	12	42,00	3	009511610

951GP/S6
3-4-5-6-8-10 mm

€ 164,50

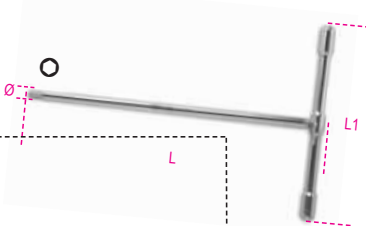
1 009511687

Interpretazione delle sigle più correnti

Esempio

nelle serie	
B	= in busta di plastica 42/B9N
BV	= busta vuota 2002/BV9
C	= in cassetta 900/C11
D	= in confezione appendibile 1293/D6
S	= in scatola 42/S17
SP	= con supporto 42/SP25
SPV	= supporto vuoto 42/SPV7
SC	= con supporto compatto 96/SC9
SCV	= supporto compatto vuoto 96/SCV

negli assortimenti	
AS	= con chiavi in pollici 5915VU/AS
E	= versione Elettronica/Elettrotecnica 5980ET/A
I	= versione Idraulica 5980ID
MT	= versione Movimento Terra 5902MT
U	= versione Universale 5915VU/3
SBK	= versione Motoriparazione 5940SBK
VG	= versione Autoriparatori 5904VG/5T
VI	= versione Industria 5902VI

nelle chiavi a bussola	
A	= profilo esagonale 910A
B	= profilo poligonale 910B
ES	= profilo esascalato 920ES
FTX	= per viti TORX® 910FTX

Interpretazione delle sigle più correnti

Esempio

PT	= per viti pentalobate	910PT
X	= cricchetto reversibile nelle cassette	920A/C12X

nei giravite e inserti per avvitatori		
LP	= per viti con intaglio	920LP
PE	= per viti con impronta esagonale	920PE
PH	= per viti con impronta PHILLIPS®	920PH
PZ	= per viti con impronta POZIDRIV® - SUPADRIV®	1299PZ
RTX	= per viti con impronta TAMPER RESISTANT TORX®	1298RTX
SP	= per viti con impronta SPANNER	861SP
TRW	= per viti con impronta TRI-WING®	861TRW
TQS	= per viti con impronta TORQ-SET®	861TQS
TX	= per viti con impronta TORX®	920TX
XZN	= per viti con impronta XZN®	920XZN

in generale		
AS	= misure in pollici	42AS
BA	= utensili antiscintilla	42BA
BM	= impugnatura bimateriale	1150BM
C	= contenitore metallico vuoto	C25
HS	= utensili anticaduta	42HS
INOX	= utensili acciaio inossidabile	42 INOX
L	= modello lungo	952L
MQ	= utensili isolati a 1000V	1150MQ
MP	= finitura lucida	42MP
R	= ricambio	338R

Le immagini riprodotte sono indicative.

Beta Utensili S.p.A. si riserva il diritto di apportare aggiornamenti e migliorie alla propria gamma produttiva senza preavviso.



Beta **RACCOMANDA** il corretto utilizzo degli utensili
ed il rispetto delle disposizioni per la sicurezza individuale.



UTENSILI A PERCUSSIONE

Gli utensili a percussione Beta sono progettati per ottenere le migliori performance garantendo sempre la massima sicurezza dell'operatore.

Per la produzione viene impiegato un acciaio speciale che contiene cromo, molibdeno e vanadio (65CrMoV2-2) che permette di ottenere durezza molto elevate mantenendo una notevole tenacità dell'utensile. Dove le geometrie lo consentono i prodotti sono realizzati partendo da barra trafilata, negli altri casi sono forgiati a caldo in atmosfera controllata per evitare la formazione di scoria.

1
I profili esagonali evitano all'utensile di rotolare sulla superficie di appoggio.

2
I cacciapina hanno lo stelo molto lungo ma sempre perfettamente rettilineo per consentire l'accesso anche con poco spazio di manovra.

3
Per assicurare la corretta dimensione dei cacciapina, effettuiamo l'intestatura di ogni singolo pezzo in modo che la parte cilindrica sia uniforme e l'estremità perfettamente piatta per una maggiore efficacia.

4
Tutti i battenti subiscono un processo di rinvenimento a induzione per escludere la propagazione di schegge; la deformazione del punto di battuta è una naturale conseguenza per salvaguardare la sicurezza dell'operatore.

5
L'affilatura di bulini e scalpelli avviene dopo il trattamento di cromatura per conferire maggiore capacità di incisione e taglio ma anche al fine di asportare il deposito galvanico dalla punta; occorre infatti eliminare il sovra deposito che tendenzialmente "arrotonda" gli spigoli e infragilisce il prodotto a causa dell'idrogeno prodotto durante l'elettrodeposizione. Le zone lavorate sono protette con uno strato protettivo anti ruggine.



30 punzoni



Ø mm	L mm	€	Icona	Icona
2	125	7,55	10	000300020
3	125	7,55	10	000300030
4	150	10,10	10	000300040
5	150	10,10	10	000300050
6	150	10,60	10	000300060

31 cacciapina



Ø mm	L mm	L1 mm	€	Icona	Icona
2	110	22	7,55	10	000310002
3	128	35	7,80	10	000310003
4	146	45	9,60	10	000310004
5	164	55	10,10	10	000310005
6	182	65	12,70	5	000310006
8	200	80	13,40	5	000310008
10	220	95	16,80	5	000310010



Modello	€	Icona	Icona
31/B6N 2-3-4-5-6-8 mm	70,00	1	000310024
2002/BV6	9,10	1	020020000
31/SP6 2-3-4-5-6-8 mm	83,00	1	000310030
31/SPV	21,00	1	000310031

31BM cacciapina con impugnatura



Ø mm	L mm	L1 mm	€	Icona	Icona
2	168	42	15,50	2	000310402
3	180	52	15,90	2	000310403
4	191	62	17,40	2	000310404
5	200	72	18,30	2	000310405
6	221	82	21,00	2	000310406
8	235	94	22,10	2	000310408



Modello	€	Icona	Icona
31BM/D6 2-3-4-5-6-8 mm	110,00	1	000310420

31L cacciapina tipo lungo



Ø mm	L mm	L1 mm	€	Icona	Icona
4	175	80	11,40	5	000310104
5	175	80	12,20	5	000310105
6	175	80	14,40	5	000310106

31SE cacciapina per spine elastiche

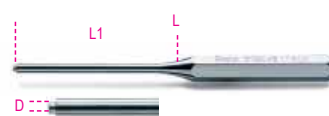

Ø mm	D mm	L mm	L1 mm	€	Icona	Icona
4	2,4	175	80	11,40	5	000310204
5	3,0	175	80	12,20	5	000310205
6	3,6	175	80	14,40	5	000310206



Modello	€	Icona	Icona
31/B6N-LSE 31L: 4-5-6 mm 31SE: 4-5-6 mm 2002/BV6	85,00	1	000310324
	9,10	1	020020000

32 bulini



Ø mm	L mm	L1 mm	€	Icona	Icona
3	100	44	7,00	10	000320100
4	125	52	8,70	10	000320125
5	150	62	10,60	10	000320150

32AU bulino automatico

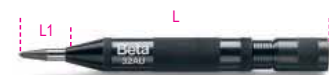

Ø mm	L mm	L1 mm	€	Icona	Icona
3	150	23	57,00	2	000320160

32AUR

punta di ricambio



Ø mm	€	5	000320170
3	10,30		

33LT

punzoni con lettere

- Per incisione su acciaio con resistenza R fino a 80 kg/mm²
- Kit composto da 27 punzoni: lettere dalla A alla Z + &



H mm	L mm	A mm	€	1	000330023
3	60	6,35	64,00		
4	63	7,93	78,00		
5	61	7,93	78,00		
6	68	9,52	96,00		
8	70	12,7	144,00		

33NR

punzoni con numeri

- Per incisione su acciaio con resistenza R fino a 80 kg/mm²
- Kit composto da 9 punzoni: numeri dallo 0 al 9



H mm	L mm	A mm	€	1	000330003
3	61	6,35	22,80		
4	62	7,93	27,50		
5	62	7,93	27,50		
6	68	9,52	33,50		
8	71	12,7	49,00		

34

scalpelli piatti



L mm	A mm	L1 mm	€	5	000340001
125	14,5	45	10,90		
150	17,0	58	14,30		
175	21,5	68	20,70		

35

scalpelli nervati



L mm	A mm	€	5	000350001
100	14,5	12,80		
125	17,0	14,30		
150	20,5	17,80		
200	23,0	27,00		
250	28,5	38,50		
300	34,0	53,00		

35PM

scalpelli nervati con paramano



L mm	A mm	€	2	000350014
200	23,0	40,50		
250	28,5	52,00		
300	34,0	67,00		

35PMR

ricambi paramano



L mm	€	1	000350024
200	13,40		
250	13,40		
300	14,10		

36

ugnetti



L mm	A mm	L1 mm	€	5	000360001
125	4	44	11,40		
150	6	53	13,40		

37

ugnetti nervati



L mm	A mm	L1 mm	€	5	000370001
150	6	45	20,50		
200	8	55	29,50		

37PM

ugnetto nervato con paramano



L mm	A mm	€	2	000370012
200	8	43,50		

37PMR

ricambio paramano



L mm	€	1	000370022
200	14,10		



38/B6N



38/SP6

38/B6N	€	1	000380016
30: 2-3 mm			
32: 4 mm			
34: 125-150 mm			
36: 150 mm			
2002/BV6	9,10		020020000
38/SP6	84,50		000380009
30: 2-3 mm			
32: 4 mm			
34: 125-150 mm			
36: 150 mm			
38/SPV	24,00		000380019



42 LA ICONICA CHIAVE BETA

Una forma elegante e snella, alleggerita nelle linee e più leggera al tatto.

La forza, la resistenza e l'ergonomia della chiave Beta raggiungono valori ancora superiori per offrire la miglior chiave possibile alle mani degli utilizzatori. Il processo produttivo si svolge nei nostri stabilimenti di Sovico e Sulmona, avvalendosi delle tecnologie più avanzate in termini di automazione e degli operatori più preparati in termini di esperienza.

RAPIDITÀ

Angolo di 15° rispetto all'asse per ridurre l'angolo di ripresa

RESISTENZA

Grande resistenza: nel caso di uso improprio la chiave inizia a deformarsi, non si spezza in modo improvviso

OMOGENEITÀ

Lo stampaggio parte da un semilavorato a sezione tonda che garantisce alle fibre una distribuzione omogenea escludendo la formazione di pericolose tensioni interne

ACCESSIBILITÀ

Spessori ridotti per migliorare l'accessibilità

PROTEZIONE

La nichel-cromatura garantisce nel tempo la protezione dagli agenti esterni e supera le impegnative prove di aderenza della norma ISO 2819

OTTIMIZZAZIONE

La lunghezza della chiave, superiore alla maggior parte dei concorrenti, permette di ottenere coppie elevate con sforzo minore

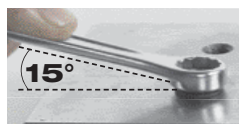

ERGONOMIA

L'occhio poligonale è inclinato di 15° per proteggere la mano. La forma è ottenuta da stampo, non piegata successivamente



ATTENZIONE!

La forma della chiave 42 è perfettamente compatibile con tutti i contenitori e i moduli della chiave 42 storica

42

chiavi combinate

Coppe di serraggio più che doppie rispetto ai requisiti della norma ISO 1711



DIN 3113 UNI-ISO 7738

mm	L mm	S1 mm	€		
5,5x5,5	95	3,4	8,30	5	000421005
6x6	95	3,4	8,40	5	000421006
7x7	105	3,6	8,45	5	000421007
8x8	116	3,9	8,80	5	000421008
9x9	127	4,2	9,15	5	000421009
10x10	137	4,5	9,40	5	000421010
11x11	148	4,8	10,00	5	000421011
12x12	158	5,1	10,10	5	000421012
13x13	169	5,6	10,20	5	000421013
14x14	180	5,7	11,70	5	000421014
15x15	190	6,0	12,90	5	000421015
16x16	201	6,3	13,40	5	000421016
17x17	212	6,8	14,00	5	000421017
18x18	222	7,0	14,90	5	000421018
19x19	233	7,5	15,40	5	000421019
20x20	243	7,7	17,30	3	000421020
21x21	254	7,9	18,70	3	000421021
22x22	264	8,3	19,20	3	000421022
23x23	275	8,5	20,80	3	000421023
24x24	285	8,7	22,00	3	000421024
25x25	296	8,7	23,20	2	000421025
26x26	307	8,9	25,00	2	000421026
27x27	317	9,1	27,00	2	000421027
28x28	328	9,3	27,50	2	000421028
29x29	338	9,5	30,50	2	000421029
30x30	349	9,7	32,00	2	000421030
32x32	370	10,1	35,00	2	000421032
34x34	391	10,5	66,50	1	000421034
35x35	412	10,7	71,00	1	000421035
36x36	412	10,7	74,00	1	000421036
38x38	433	11,3	82,00	1	000421038
41x41	465	12,0	92,50	1	000421041



42/B9N	€ 108,00	1	000421074
6-7-8-10-11-13-14-17-19 mm			
2002/BV9	€ 11,60	1	020020030





42/S14 6-7-8-10-11-12-13-14 -15-16-17-19-22-24 mm	€ 174,00	1	000421067
42/S17 6-7-8-9-10-11-12-13-14-15 16-17-18-19-20-21-22 mm	212,00	1	000421065
42/S15 6-7-8-10-11-12-13-14 17-19-22-24-27-30-32 mm	241,50	1	000421066
42/S17X 6-7-8-10-11-12-13-14- 15-16-17-19-21-22- 24-27-30 mm	252,00	1	000421068
42/S26 6-7-8-9-10-11-12-13-14 15-16-17-18-19-20-21 22-23-24-25-26-27-28 29-30-32 mm	455,00	1	000421070

42/SC9I-E

serie di 9 chiavi combinate con supporto compatto



42/SC9I 8-10-11-12-13-14-15-17-19 mm	€ 111,00	1	000421087
142/SCV9I	10,50	1	001420103
42/SC9E 8-10-11-12-13-16-17-18-19 mm	114,50	1	000421088
142/SCV9E	10,50	1	001420104



42/SP25 6-7-8-9-10-11-12-13-14 15-16-17-18-19-20-21 22-23-24-25-26-27-28 30-32 mm	€ 487,00	1	000421085
42/SPV2	63,00	1	000420090



42/SP15 6-7-8-9-10-11-12-13-14-15 16-17-19-22-24 mm	€ 189,50	1	000421078
42/SPV7 42: 8-10-11-13-14-17-19 mm 55: 6x7-8x9-10x11-12x13 14x15-16x17-18x19 mm	7,45	1	000420097
42/SPV11 42MP: 8-9-10-11-12-13 14-15-16-17-19 mm 142-142SN: 8-9-10-11-12-13 14-15-16-17-19 mm	10,50	1	000420100
42/SPV15 42: 6-7-8-9-10-11-12-13-14 15-16-17-19-22-24 mm	14,20	1	000420102

42AS

chiavi combinate



"	L mm	€		
1/4x1/4	95	10,10	2	000420106
9/32x9/32	106	10,20	2	000420107
5/16x5/16	116	10,30	2	000420108
3/8x3/8	137	11,40	2	000420110
7/16x7/16	148	12,20	2	000420111
1/2x1/2	169	12,60	2	000420113
9/16x9/16	180	13,70	2	000420114
19/32x19/32	191	15,00	2	000420115
5/8x5/8	201	15,90	2	000420116
11/16x11/16	212	17,00	2	000420117
3/4x3/4	233	18,10	2	000420119
13/16x13/16	254	21,90	2	000420121
7/8x7/8	264	22,60	2	000420122
15/16x15/16	285	26,50	2	000420124
1x1	296	27,00	2	000420125
1.1/16x1.1/16	317	31,00	2	000420127
1.1/8x1.1/8	338	33,50	2	000420129
1.1/4x1.1/4	370	41,00	2	000420132
1.5/16x1.5/16	391	67,00	1	000420133
1.3/8x1.3/8	412	77,00	1	000420135
1.7/16x1.7/16	412	79,50	1	000420136
1.1/2x1.1/2	433	83,50	1	000420138



42AS/B9N 1/4-5/16-3/8-7/16-1/2 9/16-5/8-11/16-3/4 2002/BV9	€ 133,00	1	000420159
2002/BV9	11,60	1	020020030



42AS/13 1/4-5/16-3/8-7/16-1/2-9/16-5/8 11/16-3/4-13/16-7/8-15/16-1	€ 219,50	1	000420163
42AS/16 1/4-5/16-3/8-7/16-1/2-9/16-5/8 11/16-3/4-13/16-7/8-15/16-1- 1.1/16-1.1/8-1.1/4	325,00	1	000420166
42AS/17 1/4-9/32-5/16-3/8-7/16-1/2- 9/16-19/32-5/8-11/16-3/4- 13/16-7/8-15/16-1-1.1/16-1.1/8	309,00	1	000420168

42MP

chiavi combinate lucide



DIN 3113 UNI-ISO 7738

"	L mm	€		
6x6	95	13,80	5	000420606
7x7	105	13,90	5	000420607
8x8	116	14,00	5	000420608
9x9	127	14,10	5	000420609
10x10	137	14,20	5	000420610
11x11	148	14,50	5	000420611
12x12	158	14,60	5	000420612
13x13	169	14,80	5	000420613
14x14	180	16,00	5	000420614
15x15	190	17,30	5	000420615
16x16	201	18,30	5	000420616
17x17	212	19,10	5	000420617
18x18	222	20,40	5	000420618
19x19	233	21,10	5	000420619
20x20	243	24,10	3	000420620
21x21	254	25,50	3	000420621
22x22	264	26,00	3	000420622
24x24	285	30,00	3	000420624
27x27	317	35,50	3	000420627
30x30	349	44,00	3	000420630
32x32	370	46,00	3	000420632



42MP/B9N 6-7-8-10-11-13-14-17-19 mm	€ 153,00	1	000420661
2002/BV9	11,60	1	020020030



42MP/S17 6-7-8-9-10-11-12-13-14-15 16-17-18-19-20-21-22 mm	€ 302,00	1	000420652
42MP/S21 6-7-8-9-10-11-12-13-14 15-16-17-18-19-20-21-22 24-27-30-32 mm	457,00	1	000420653

42LMP

chiavi combinate lunghe lucide



Ø mm	L mm	€		
8x8	148	13,20	2	000420508
9x9	167	13,60	2	000420509
10x10	172	14,10	2	000420510
11x11	186	14,80	2	000420511
12x12	197	15,10	2	000420512
13x13	207	15,40	2	000420513
14x14	223	16,40	2	000420514
15x15	233	18,00	2	000420515
16x16	243	19,40	2	000420516
17x17	261	20,50	2	000420517
18x18	270	22,50	2	000420518
19x19	280	23,00	2	000420519
21x21	301	26,50	2	000420521
22x22	318	27,50	2	000420522
24x24	338	32,00	2	000420524
27x27	376	36,50	2	000420527
30x30	409	46,50	2	000420530
32x32	435	50,50	2	000420532



42LMP/S14 € 260,00 1 000420551

8-9-10-11-12-13-14
15-16-17-18-19-21-22 mm

42LMP/S18 € 425,00 1 000420552

8-9-10-11-12-13-14
15-16-17-18-19-21-22
24-27-30-32 mm

42SLIM

chiavi combinate a testa ribassata



DIN 3113 UNI-ISO 7738

Ø mm	L mm	S1 mm	€		
8x8	116	3,4	9,55	5	000420408
10x10	137	3,8	10,30	5	000420410
11x11	148	3,8	10,70	5	000420411
12x12	158	4,2	11,00	5	000420412
13x13	169	4,4	11,30	5	000420413
14x14	180	4,6	12,70	5	000420414
15x15	190	4,7	14,00	5	000420415
16x16	201	4,7	14,50	5	000420416
17x17	212	5,1	14,90	5	000420417
18x18	222	5,1	16,10	5	000420418
19x19	233	5,6	16,40	5	000420419



42SLIM/B8NI € 113,00 1 000420478

10-11-12-13-14-15-17-19 mm

42SLIM/B8NE € 117,00 1 000420479

10-11-12-13-16-17-18-19 mm

2002/BV8 € 11,60 1 020020020



42SLIM/S11 € 141,50 1 000420471

8-10-11-12-13-14-15-

16-17-18-19 mm

45

chiavi combinate tipo pesante



DIN 3113 UNI-ISO 7738

Ø mm	L mm	€		
46x46	500	192,00	1	000450046
50x50	540	216,00	1	000450050
55x55	560	309,00	1	000450055
60x60	600	396,00	1	000450060
65x65	675	475,00	1	000450065
70x70	675	520,00	1	000450070
75x75	720	606,00	1	000450075
80x80	720	699,00	1	000450080

52

chiavi a forchetta semplici



UNI 6733 DIN 3114

Ø mm	L mm	€		
10	119	10,10	5	000520010
11	119	10,30	5	000520011
12	119	10,60	5	000520012
13	145	12,00	5	000520013
14	145	12,30	5	000520014
15	145	12,60	5	000520015
16	159	13,60	5	000520016
17	159	13,70	5	000520017
18	159	14,60	5	000520018
19	175	15,90	5	000520019
20	175	17,00	5	000520020
21	175	17,50	5	000520021
22	196	19,70	2	000520022
23	196	20,30	2	000520023
24	196	20,70	2	000520024
25	215	23,30	2	000520025
26	215	23,70	2	000520026
27	215	23,80	2	000520027
28	240	27,50	2	000520028
30	240	28,00	2	000520030
32	270	33,50	2	000520032
34	270	36,50	1	000520034
35	295	42,00	1	000520035
36	295	42,00	1	000520036
38	295	47,00	1	000520038
40	335	57,50	1	000520040
41	335	57,50	1	000520041
42	335	64,00	1	000520042
45	370	73,50	1	000520045
46	370	73,50	1	000520046
48	370	85,00	1	000520048
50	415	99,00	1	000520050
52	415	111,00	1	000520052
55	415	115,00	1	000520055
60	490	146,00	1	000520060
65	490	148,50	1	000520065
70	490	168,00	1	000520070

53

chiavi a forchetta DIN 894



Ø mm	L mm	€		
36	317	31,00	1	000530036
38	320	34,00	1	000530038
41	342	40,00	1	000530041
46	396	48,50	1	000530046
50	412	76,00	1	000530050
55	457	87,00	1	000530055
60	492	107,50	1	000530060
65	528	127,50	1	000530065
70	572	147,50	1	000530070
75	608	185,00	1	000530075
80	645	226,50	1	000530080
85	690	275,00	1	000530085
90	690	326,00	1	000530090
95	847	455,00	1	000530095
100	847	481,00	1	000530100
105	1000	600,00	1	000530105
110	1000	649,00	1	000530110
115	1000	724,00	1	000530115
120	1000	821,00	1	000530120
125	1000	948,00	1	000530125
130	1000	1.016,00	1	000530130
135	1000	1.090,00	1	000530135

55

chiavi a forchetta doppie



UNI-ISO 10102 DIN 3110

Ø mm	L mm	€		
4x5	101	5,95	5	000550003
5x5,5	101	6,75	5	000550006
5,5x7	120	6,75	5	000550009
• 6x7	120	5,30	5	000550012
7x8	140	6,75	5	000550018
• 8x9	140	5,40	5	000550021
8x10	140	6,75	5	000550024
• 10x11	155	5,70	5	000550030
10x12	155	7,75	5	000550033
10x13	170	8,50	5	000550035
• 12x13	170	6,45	5	000550042
12x14	170	8,70	5	000550045
13x14	185	9,75	5	000550047
13x17	189	10,40	5	000550051
• 14x15	185	8,10	5	000550054
14x17	189	11,20	5	000550057
• 16x17	202	9,25	5	000550060
17x19	220	12,50	2	000550063
• 18x19	220	11,00	2	000550066
19x22	236	14,20	2	000550069
• 20x22	236	12,50	2	000550075
• 21x23	245	13,30	2	000550078
22x24	245	15,40	2	000550081
• 24x26	262	15,80	2	000550087
24x27	262	17,20	2	000550090
• 25x28	272	18,00	2	000550096
• 27x29	284	20,40	2	000550099
27x30	284	23,50	2	000550102
27x32	297	25,50	2	000550105
• 30x32	297	22,60	2	000550108
32x36	325	69,50	1	000550114
34x36	325	69,50	1	000550117
35x38	375	77,00	1	000550120
36x41	375	80,50	1	000550123
41x46	425	92,00	1	000550129
46x50	475	114,00	1	000550132
50x55	500	132,50	1	000550135
55x60	500	140,00	1	000550138



55/B8N	€ 75,50	1	000550160
6x7-8x9-10x11-12x13 14x15-16x17-18x19 20x22 mm			
2002/BV8	11,60	1	020020020
55/B12N	152,50	1	000550164
6x7-8x9-10x11-12x13 14x15-16x17-18x19 20x22-21x23-24x26 25x28-30x32 mm			
2002/BV12	19,30	1	020020040



55/S8	€ 63,50	1	000550174
6x7-8x9-10x11-12x13 14x15-16x17-18x19 20x22 mm			
55/S12	133,50	1	000550178
6x7-8x9-10x11-12x13 14x15-16x17-18x19 20x22-21x23-24x26 25x28-30x32 mm			
55/S12X	135,00	1	000550179
6x7-8x9-10x11-12x13 14x15-16x17-18x19 20x22-21x23-24x27 25x28-30x32 mm			
55/S13	154,00	1	000550182
6x7-8x9-10x11-12x13 14x15-16x17-18x19 20x22-21x23-24x26 25x28-27x29-30x32 mm			



55/SP7

55/SP13

55/SP7	€ 54,00	1	000550167
6x7-8x9-10x11-12x13 14x15-16x17-18x19 mm			
42/SPV7	7,45	1	000420097
42: 8-10-11-13-14-17-19 mm			
55: 6x7-8x9-10x11-12x13			
14x15-16x17-18x19 mm			
55/SP13	191,00	1	000550186
6x7-8x9-10x11-12x13 14x15-16x17-18x19 20x22-21x23-24x26 25x28-27x29-30x32 mm			
55/SPV	37,00	1	000550190

55AS chiavi a forchetta doppie



mm	L mm	€		
1/4x9/32	120	7,10	2	000550203
1/4x5/16	120	7,10	2	000550206
5/16x11/32	140	7,65	2	000550209
5/16x3/8	140	7,65	2	000550212
3/8x7/16	155	8,25	2	000550215
7/16x1/2	170	9,10	2	000550218
1/2x9/16	170	9,75	2	000550221
9/16x5/8	185	10,70	2	000550224
19/32x11/16	189	13,10	2	000550227
5/8x11/16	202	13,10	2	000550230
5/8x3/4	202	14,70	2	000550233
11/16x13/16	220	15,30	2	000550242
3/4x7/8	236	16,50	2	000550245
25/32x13/16	236	16,50	2	000550244
7/8x15/16	245	17,80	2	000550251
15/16x1	262	22,60	1	000550257
1x1.1/8	272	23,80	1	000550259
1.1/16x1.1/4	284	31,00	1	000550267
1.1/8x1.5/16	297	31,00	1	000550266
1.5/16x1.1/2	325	82,00	1	000550269
1.3/8x1.1/2	375	90,50	1	000550272
1.7/16x1.5/8	375	90,50	1	000550275



55AS/5	€ 55,00	1	000550290
5/16x11/32-3/8x7/16 1/2x9/16-5/8x11/16 3/4x7/8			
55AS/8	88,50	1	000550296
1/4x9/32-5/16x11/32-3/8x7/16- 1/2x9/16-9/16x5/8-5/8x11/16- 11/16x13/16-3/4x7/8			
55AS/12	182,00	1	000550298
1/4x9/32-5/16x11/32-3/8x7/16-1 /2x9/16-9/16x5/8-5/8x11/16- 11/16x13/16-25/32x13/16-3/4x7/8- 15/16x1-1x1.1/8-1.1/16x1.1/4			

55MP chiavi a forchetta doppie lucide



UNI-ISO 10102 DIN 3110

mm	L mm	€		
6x7	120	7,05	2	000550603
8x9	140	7,55	2	000550606
10x11	155	8,40	2	000550609
12x13	170	9,15	2	000550612
14x15	185	10,90	2	000550615
16x17	202	12,80	2	000550618
18x19	220	14,80	2	000550621
20x22	236	17,00	2	000550624
21x23	245	18,50	2	000550627
24x26	262	22,10	1	000550630
25x28	272	23,30	1	000550633
27x29	284	27,00	1	000550636
30x32	297	30,50	1	000550639

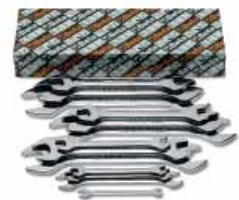

55MP/S8	€ 87,50	1	000550650
6x7-8x9-10x11-12x13 14x15-16x17-18x19 20x22 mm			
55MP/S13	209,00	1	000550651
6x7-8x9-10x11-12x13 14x15-16x17-18x19 20x22-21x23-24x26 25x28-27x29-30x32 mm			
55MP/S12	182,00	1	000550653
6x7-8x9-10x11-12x13-14x15- 16x17-18x19-20x22-21x23-24x26- 25x28-30x32 mm			

58 chiavi a forchetta a percussione



DIN 133

mm	L mm	€		
24	177	32,00	1	000580024
27	180	33,50	1	000580027
30	190	37,00	1	000580030
32	190	38,50	1	000580032
34	200	48,50	1	000580034
36	215	50,00	1	000580036
41	235	59,50	1	000580041
46	255	79,50	1	000580046
50	275	89,00	1	000580050
55	300	107,00	1	000580055
60	320	117,00	1	000580060
65	342	153,50	1	000580065
70	375	198,00	1	000580070
75	375	216,00	1	000580075
80	408	316,00	1	000580080
85	408	354,00	1	000580085
90	445	408,00	1	000580090
95	445	420,00	1	000580095
100	485	581,00	1	000580100
105	485	656,00	1	000580105
110	510	718,00	1	000580110
115	510	818,00	1	000580115
120	545	843,00	1	000580120
125	545	965,00	1	000580125
130	575	1.305,00	1	000580130
135	575	1.370,00	1	000580135
*140	575	1.485,00	1	000580140
*145	640	2.035,00	1	000580145
*150	640	2.115,00	1	000580150
*155	640	2.315,00	1	000580155
*160	640	2.540,00	1	000580160
*165	715	2.720,00	1	000580165
*170	715	3.710,00	1	000580170
*175	715	3.920,00	1	000580175
*180	715	4.250,00	1	000580180
*185	715	4.370,00	1	000580185
*190	800	4.800,00	1	000580190
*195	800	5.040,00	1	000580195
*200	800	5.280,00	1	000580200
*210	800	6.590,00	1	000580210
*220	800	8.500,00	1	000580220
*230	800	10.380,00	1	000580230

73

chiavi a forchetta doppi piccole



UNI 6737

mm	L mm	€		
4x4	78	8,90	5	000730040
4,5x4,5	78	8,90	5	000730045
5x5	78	8,90	5	000730050
5,5x5,5	86	9,65	5	000730055
6x6	86	9,65	5	000730060
7x7	86	9,65	5	000730070
8x8	97	10,10	5	000730080
9x9	97	10,10	5	000730090
10x10	108	10,90	5	000730100
11x11	108	10,90	5	000730110
12x12	124	12,60	5	000730120
13x13	124	12,60	5	000730130
14x14	124	12,60	5	000730140



73/B13N	€ 147,00	1	000730202
4-4,5-5-5,5-6-7-8-9			
10-11-12-13-14 mm			
2002/BV13	€ 11,60	1	020020050



73/S13	€ 135,50	1	000730210
4-4,5-5-5,5-6-7-8-9			
10-11-12-13-14 mm			

78

chiavi poligonali a percussione



DIN 7444

mm	L mm	€		
24	162	32,50	1	000780024
27	180	38,00	1	000780027
30	190	45,00	1	000780030
32	190	48,00	1	000780032
34	200	55,00	1	000780034
36	205	59,50	1	000780036
41	225	77,00	1	000780041
46	235	86,00	1	000780046
50	250	102,00	1	000780050
55	265	116,50	1	000780055
60	275	142,00	1	000780060
65	295	179,50	1	000780065
70	325	180,50	1	000780070
75	325	214,00	1	000780075
80	350	328,00	1	000780080
85	350	359,00	1	000780085
90	390	439,00	1	000780090
95	390	508,00	1	000780095
100	420	562,00	1	000780100
105	420	663,00	1	000780105
110	450	724,00	1	000780110
115	450	824,00	1	000780115
120	490	1.133,00	1	000780120
125	480	1.530,00	1	000780125
130	520	1.765,00	1	000780130
135	520	1.890,00	1	000780135
*140	520	2.150,00	1	000780140
*145	580	2.710,00	1	000780145
*150	580	2.840,00	1	000780150
*155	580	3.270,00	1	000780155
*160	650	3.350,00	1	000780160
*165	650	3.560,00	1	000780165
*170	650	4.270,00	1	000780170
*175	650	4.620,00	1	000780175
*180	650	5.070,00	1	000780180
*185	695	5.230,00	1	000780185
*190	695	5.720,00	1	000780190
*195	695	5.730,00	1	000780195
*200	695	5.810,00	1	000780200
*210	740	6.200,00	1	000780210
*215	740	6.940,00	1	000780215
*220	740	7.650,00	1	000780220
*230	740	9.480,00	1	000780230

78AS

chiavi poligonali a percussione



mm	L mm	€		
*1.1/16	180	46,00	1	000780327
*1.1/8	190	46,00	1	000780329
*1.3/16	190	46,00	1	000780330
*1.1/4	197	50,00	1	000780332
*1.5/16	197	51,50	1	000780333
*1.3/8	223	55,00	1	000780335
*1.7/16	223	66,50	1	000780336
*1.1/2	223	68,50	1	000780338
*1.5/8	223	78,00	1	000780341
*1.11/16	225	81,50	1	000780343
*1.13/16	240	90,00	1	000780346
*1.7/8	250	91,00	1	000780348
*2	250	104,00	1	000780350
*2.1/16	250	107,50	1	000780352
*2.3/16	275	113,50	1	000780355
*2.3/8	270	153,50	1	000780360
*2.9/16	302	170,00	1	000780365

mm	L mm	€		
*2.3/4	350	185,00	1	000780370
*2.15/16	350	213,50	1	000780375
*3.1/8	354	353,00	1	000780380

80

chiavi a bussola poligonale snodate doppie



mm	L mm	€		
6x7	170	36,00	3	000800006
8x9	176	37,00	3	000800008
8x10	179	37,00	3	000800009
10x11	182	39,00	3	000800010
12x13	228	44,50	3	000800012
14x15	232	45,00	3	000800014
13x17	231	48,00	3	000800015
16x17	234	48,00	2	000800016
18x19	285	59,50	2	000800018
19x22	287	62,50	2	000800019
20x22	289	62,50	2	000800020
21x23	289	63,50	2	000800021
24x27	405	104,00	2	000800024
30x32	413	110,50	2	000800030

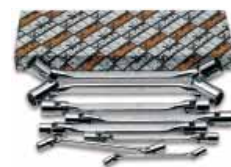

80/S8	€ 371,00	1	000800051
6x7-8x9-10x11-12x13-14x15			
16x17-18x19-20x22 mm			
80/S11	€ 649,00	1	000800056
6x7-8x9-10x11-12x13			
14x15-16x17-18x19-20x22			
21x23-24x27-30x32 mm			

83

chiavi poligonali per starter



ISO 3318

mm	L mm	€		
8x10	126	18,30	3	000830008
10x12	137	19,20	3	000830010
11x13	138	19,70	3	000830011
14x17	183	24,80	3	000830014
15x17	184	28,00	2	000830015
16x18	196	30,50	2	000830016
19x22	231	39,00	2	000830019



83/S3	€ 83,50	1	000830081
11x13-14x17-19x22 mm			
83/S5	€ 136,50	1	000830085
10x12-11x13-15x17			
16x18-19x22 mm			

Beta

83AS

chiavi poligonali per starter



mm	L mm	€	Wrench	Inventory
7/16x1/2	138	23,40	2	000830111
9/16x5/8	183	28,00	2	000830114
3/4x7/8	230	44,00	2	000830119



mm	L mm	€	Wrench	Inventory
83AS/3		95,50	1	000830181
7/16x1/2-9/16x5/8				
3/4x7/8				

88

chiavi poligonali doppie diritte extralunghe



mm	L mm	€	Wrench	Inventory
8x10	235	20,40	2	000880008
12x14	330	24,10	2	000880012
13x15	330	24,10	2	000880013
16x18	405	33,50	2	000880016
17x19	405	33,50	2	000880017
21x23	435	38,50	2	000880021
22x24	435	38,50	2	000880022



mm	L mm	€	Wrench	Inventory
88/S7		212,50	1	000880107
8x10-12x14-13x15-16x18-				
17x19-21x23-22x24 mm				

90

chiavi poligonali doppie curve



DIN 838 ISO 10104

mm	L mm	€	Wrench	Inventory
6x7	165	10,10	5	000900006
8x9	180	10,80	5	000900012
8x10	180	12,70	5	000900015
10x11	195	11,90	5	000900018
10x12	195	12,90	5	000900021
11x13	215	14,20	5	000900024
12x13	215	13,00	5	000900027
12x14	215	14,90	5	000900030
14x15	230	14,20	5	000900033
14x17	250	17,60	5	000900036
16x17	250	16,20	5	000900039
17x19	265	20,90	5	000900042
18x19	265	18,90	5	000900045
19x22	285	23,50	3	000900048
20x22	285	21,80	3	000900051
21x23	305	24,60	2	000900057
22x24	305	26,50	2	000900060
24x26	325	27,50	2	000900063
24x27	325	30,50	2	000900067
25x28	340	33,00	2	000900070
27x29	355	35,50	2	000900073
27x30	355	38,50	2	000900076
27x32	375	43,00	2	000900078
30x32	375	40,00	2	000900080
32x36	395	59,50	1	000900088
34x36	415	70,50	1	000900089
35x38	415	71,50	1	000900091
36x41	435	81,50	1	000900094
41x46	460	117,00	1	000900097
46x50	500	154,50	1	000900100



mm	L mm	€	Wrench	Inventory
90/B8N		128,50	1	000900156
6x7-8x9-10x11-12x13				
14x15-16x17-18x19				
20x22 mm				
2002/BV8		11,60	1	020020020



mm	L mm	€	Wrench	Inventory
90/S8		117,00	1	000900162
6x7-8x9-10x11-12x13				
14x15-16x17-18x19				
20x22 mm				
90/S12		242,00	1	000900166
6x7-8x9-10x11-12x13				
14x15-16x17-18x19				
20x22-21x23-24x26				
25x28-30x32 mm				
90/S12X		245,00	1	000900167
6x7-8x9-10x11-12x13				
14x15-16x17-18x19				
20x22-21x23-24x27				
25x28-30x32 mm				
90/S13		277,00	1	000900170
6x7-8x9-10x11-12x13				
14x15-16x17-18x19				
20x22-21x23-24x26				
25x28-27x29-30x32 mm				



mm	L mm	€	Wrench	Inventory
90/SP13		314,00	1	000900174
6x7-8x9-10x11-12x13				
14x15-16x17-18x19				
20x22-21x23-24x26				
25x28-27x29-30x32 mm				
55/SPV		37,00	1	000550190

90AS

chiavi poligonali doppie curve



mm	L mm	€	Wrench	Inventory
1/4x5/16	165	11,60	2	000900203
5/16x11/32	180	12,50	2	000900206
5/16x3/8	180	12,80	2	000900209
3/8x7/16	195	13,00	2	000900212
7/16x1/2	215	14,60	2	000900215
1/2x9/16	230	16,70	2	000900218
9/16x5/8	230	16,70	2	000900221
19/32x11/16	250	18,20	2	000900222
5/8x11/16	250	18,90	2	000900224
5/8x3/4	265	22,30	2	000900227
11/16x3/4	265	22,30	1	000900230
11/16x13/16	265	22,30	1	000900233
3/4x25/32	265	26,00	1	000900235
3/4x7/8	285	26,00	1	000900237
13/16x7/8	285	26,50	1	000900240
7/8x15/16	305	26,50	1	000900243
15/16x1	325	32,00	1	000900252
1.1/16x1.1/4	375	46,00	1	000900258
1.1/8x1.5/16	375	46,50	1	000900261



mm	L mm	€	Wrench	Inventory
90AS/8		153,50	1	000900298
1/4x5/16-5/16x11/32				
3/8x7/16-1/2x9/16				
5/8x11/16-11/16x3/4				
13/16x7/8-15/16x1				
90AS/10		246,00	1	000900300

mm	L mm	€	Wrench	Inventory
90AS/10		246,00	1	000900300
1/4x5/16-5/16x11/32				
3/8x7/16-1/2x9/16				
5/8x11/16-11/16x3/4				
13/16x7/8-15/16x1				
1.1/16x1.1/4-1.1/8x1.5/16				

Beta

Beta

91 chiavi poligonali curve



mm	Ø mm	€		
24	38	58,00	1	000910024
27	41	60,00	1	000910027
30	48	64,50	1	000910030
32	49	69,50	1	000910032
36	54	79,50	1	000910036
41	62	94,50	1	000910041
46	69	110,50	1	000910046
50	76	126,00	1	000910050
55	81	141,00	1	000910055
60	90	176,00	1	000910060
65	98	197,00	1	000910065
70	105	221,50	1	000910070
75	110	254,00	1	000910075
80	125	291,00	1	000910080
85	125	304,00	1	000910085
90	140	544,00	1	000910090
95	140	595,00	1	000910095
100	143	631,00	1	000910100
105	146	705,00	1	000910105

92 leve di manovra per art. 91



92/1	L mm	91 mm	Ø mm	€		
92/1	460	24÷30	19	35,00	1	000920010
92/2	610	32÷41	22	53,50	1	000920020
92/3	760	46÷55	25	76,00	1	000920030
92/4	860	60÷105	30	101,00	1	000920040

93 chiave per ponteggi



mm	L mm	€		
21x22	310	41,50	3	000930021

93C chiavi a cricchetto per ponteggi



mm	L mm	€		
17x19	310	47,00	1	000930117
19x22	310	50,50	1	000930119
19x24	365	62,00	1	000930120
21x22	310	56,50	1	000930121
36x38	445	95,00	1	000930136

94 chiavi per raccordi tubi



DIN 3118

mm	L mm	€		
8x10	140	17,60	2	000940008
9x11	153	18,30	2	000940009
10x11	153	19,30	2	000940010
11x13	175	19,90	2	000940011
12x14	175	21,10	2	000940012
13x15	175	21,10	2	000940013
14x15	175	24,80	2	000940014
14x17	195	25,50	2	000940015
17x19	212	26,00	2	000940017
19x22	228	27,50	2	000940019
22x24	242	34,00	2	000940022
24x27	260	37,00	2	000940024
30x32	300	48,00	2	000940030
36x41	320	82,00	1	000940036



94/S6	€		
8x10-10x11-11x13-12x14 17x19-19x22 mm	131,50	1	000940050
94/S10	269,00	1	000940052
8x10-9x11-10x11-11x13 12x14-17x19-19x22 22x24-24x27-30x32 mm			

95 chiavi poligonali doppie diritte



DIN 837 ISO 10103

mm	L mm	€		
6x7	120	11,50	3	000950161
8x9	135	12,40	3	000950162
10x11	150	14,00	3	000950163
12x13	165	15,20	3	000950164
14x15	185	16,00	3	000950165
16x17	210	17,00	3	000950166
17x19	225	19,70	3	000950167
18x19	225	19,70	2	000950168
20x22	240	22,30	2	000950169
21x23	255	23,50	2	000950170
24x26	270	24,80	2	000950171
25x28	285	30,00	2	000950172
27x29	315	30,50	2	000950173
30x32	335	34,50	2	000950174



95/S8	€		
6x7-8x9-10x11-12x13 14x15-16x17-18x19 20x22 mm	128,00	1	000950177
95/S13	271,00	1	000950179
6x7-8x9-10x11-12x13 14x15-16x17-18x19 20x22-21x23-24x26 25x28-27x29-30x32 mm			

95FTX chiavi doppie diritte per viti con teste a profilo Torx®



mm	L mm	€		
E6xE8	115	11,90	2	000950306
E10xE12	143	12,50	2	000950310
E14xE18	177	14,20	2	000950314
E20xE24	224	19,30	2	000950320



95FTX/S4	€		
E6xE8-E10xE12 E14xE18-E20xE24	58,00	1	000950325



Beta

CHIAVI MASCHIO ESAGONALE

meglio note come chiavi a brugola

Le chiavi maschio Beta sono realizzate per operare a lungo e con precisione. L'ampia gamma copre qualunque necessità d'impiego: chiavi extra-corte, corte, lunghe, extra-lunghe, con testa sferica fino ad arrivare alle chiavi a T e a quelle con impugnatura, veri articoli distintivi del marchio Beta e senza paragoni sul mercato.

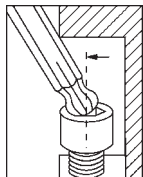

Le chiavi con estremità sferica consentono di operare fino a 30° rispetto all'asse della vite.

Il supporto con apertura a portafoglio permette di individuare rapidamente la misura necessaria. Una volta chiuso impedisce la fuoriuscita accidentale delle chiavi, anche delle più piccole.

La versione Color affianca alle ottime caratteristiche delle chiavi standard l'immediata individuazione della misura per velocizzare il lavoro quotidiano.

96

chiavi maschio esagonale piegate cromate



ISO 2936

mm	L mm	L1 mm	€		
0,9	35	8	1,02	20	000960013
1,3	39	10	1,02	20	000960014
1,5	45	15	1,02	20	000960015
2	50	17	1,08	20	000960020
2,5	57	20	1,08	20	000960025
3	64	22	1,27	20	000960030
3,5	68	25	1,51	20	000960035
4	72	28	1,58	20	000960040
4,5	78	30	1,63	20	000960045
5	83	32	1,69	20	000960050
5,5	88	35	2,13	20	000960055
6	94	37	2,13	20	000960060
7	99	40	2,64	10	000960070
8	105	43	3,10	10	000960080
9	111	46	3,65	10	000960090
10	119	49	4,35	10	000960100
11	126	52	5,45	10	000960110
12	134	56	6,55	10	000960120
13	142	62	8,35	10	000960130
14	151	69	9,80	10	000960140
16	165	75	14,40	5	000960160
17	174	79	15,10	5	000960170
19	196	88	21,10	5	000960190
22	216	100	33,00	3	000960220
24	242	112	43,50	1	000960240
27	271	125	57,50	1	000960270
30	309	140	77,50	1	000960300
32	341	155	102,00	1	000960312
36	385	174	147,00	1	000960316



96/ST6

2,5-3-4-5-6-8 mm

€ 14,70



3 000960370



96/BGS7

1,5-2-2,5-3-4-5-6 mm

€ 32,50



1 000960367



96/BG7

2,5-3-4-5-6-8-10 mm

€ 34,50



1 000960368



96/B8

2-2,5-3-4-5-6-8-10 mm

€ 18,30



5 000960386

96/B10

1,5-2-2,5-3-4-5-6-8-10-12 mm

€ 26,00



5 000960380

96N/BV

€ 1,99



1 000960651



96/SC9

1,5-2-2,5-3-4-5-6-8-10 mm

€ 21,80



1 000960374

96/SCV

€ 4,45



1 000960985



96/SC12

2-2,5-3-3,5-4-4,5-5-6-7-8-9-10 mm

€ 31,00



1 000960395

96/SCV12

€ 5,30



1 000960975

96N

chiavi maschio esagonale piegate brunite



ISO 2936

mm	L mm	L1 mm	€		
0,9	32	10	0,51	20	000960409
1,3	44	12	0,51	20	000960413
1,5	46	15	0,54	20	000960415
2	51	17	0,57	20	000960420
2,5	57	20	0,59	20	000960425
3	64	22	0,66	20	000960430
3,5	68	25	0,79	20	000960435
4	72	28	0,90	20	000960440
4,5	78	30	0,98	20	000960445
5	83	32	1,03	20	000960450
6	94	37	1,29	20	000960460
7	99	40	1,72	10	000960470
8	105	43	2,04	10	000960480
9	111	46	2,66	10	000960490
10	119	49	3,15	10	000960500
11	126	52	3,90	10	000960510
12	134	56	4,75	10	000960520
13	142	62	6,35	10	000960530
14	151	69	7,15	10	000960540
16	165	72	10,80	5	000960560
17	174	79	11,60	5	000960570
19	194	88	15,70	5	000960590
22	216	99	29,00	1	000960592
24	242	111	38,00	1	000960594



96N/ST6
2,5-3-4-5-6-8 mm

€ 10,30 3 000960640



96N/G7
2,5-3-4-5-6-8-10 mm

€ 27,00 3 000960645

96N/G7A
1,5-2-2,5-3-4-5-6 mm

€ 18,90 3 000960643



96N/B10
1,5-2-2,5-3-4-5-6-8-10-12 mm

€ 17,50 5 000960650

96N/BV
€ 1,99 1 000960651



96N/SC9
1,5-2-2,5-3-4-5-6-8-10 mm

€ 15,20 1 000960644

96N/SCV
€ 4,45 1 000960986



96N/SC12
2-2,5-3-3,5-4-4,5-5-6-7-8-9-10 mm

€ 21,70 1 000960661

96N/SCV12
€ 5,30 1 000960976

96C/AS

chiavi maschio esagonale piegate cromate



"	L mm	L1 mm	g	€		
1/16	46	16	1,01	1,79	20	000961702
3/32	53	19	2,70	2,48	20	000961706
1/8	60	22	5,33	2,61	20	000961710
5/32	67	25	9,33	3,05	20	000961714
3/16	74	28	14,87	3,45	20	000961716
7/32	81	32	22,00	3,90	20	000961718
1/4	89	35	31,40	4,35	20	000961720
5/16	103	40	56,16	4,85	10	000961724
3/8	117	45	91,31	6,00	10	000961728



96C-AS/SC9
1/16-3/32-1/8-5/32-3/16-7/32-1/4-5/16-3/8

€ 37,00 1 000961753

96AS

chiavi maschio esagonale piegate brunite



"	L mm	L1 mm	€		
1/30 (0,035")	44	14	0,91	20	000960698
1/20 (0,050")	44	15	0,91	20	000960701
1/16	46	16	0,98	20	000960702
5/64	50	18	1,21	20	000960704
3/32	53	19	1,39	20	000960706
7/64	57	21	1,43	20	000960708
1/8	60	22	1,45	20	000960710
9/64	64	24	1,73	20	000960712
5/32	68	25	1,79	20	000960714
3/16	75	29	1,99	20	000960716
7/32	82	32	2,23	20	000960718
1/4	89	35	2,61	20	000960720
5/16	103	40	3,25	10	000960724
3/8	117	44	3,95	10	000960728
7/16	132	49	5,75	10	000960730
1/2	149	54	7,25	10	000960732
9/16	151	69	11,90	2	000960734



96AS/SC9
1/16-3/32-1/8-5/32-3/16-7/32-1/4-5/16-3/8

€ 24,10 1 000960743

96AS/SCV
€ 4,45 1 000960744



96AS/T7
3/32-1/8-5/32-3/16-7/32-1/4-5/16

€ 19,50 3 000960740



96AS/BG7
3/32-1/8-5/32-3/16-1/4-5/16-3/8

€ 34,50 1 000960747



96AS/B11
1/20-1/16-5/64-3/32-1/8-5/32-3/16-7/32-1/4-5/16-3/8

€ 23,80 1 000960749

96N/BV
€ 1,99 1 000960651



96LC

chiavi maschio esagonale piegate tipo lungo, cromate



ISO 2936

mm	L mm	L1 mm	€		
2	101	17	1,94	20	000960320
2,5	113	20	2,07	20	000960321
3	127	22	2,26	20	000960322
3,5	138	25	2,31	20	000960323
4	142	28	2,51	20	000960324
4,5	154	28	2,94	20	000960325
5	163	32	3,20	20	000960326
6	184	37	3,45	20	000960327
7	194	40	3,95	10	000960328
8	205	43	4,85	10	000960329
9	216	46	5,35	10	000960330
10	231	49	6,95	10	000960331
12	259	56	8,60	10	000960332





96LC/SC8 2-2,5-3-4-5-6-8-10 mm	€ 31,50	1	000960334
96LC/SCV	4,45	1	000960983



96LC/SC12 2-2,5-3-3,5-4-4,5-5-6-7-8-9-10 mm	€ 47,00	1	000960337
96LC/SCV12	5,30	1	000960977

96L

chiavi maschio esagonale piegate tipo lungo, brunite



ISO 2936

mm	L mm	L1 mm	€		
2	99	15	1,37	20	000960820
2,5	110	17	1,42	20	000960825
3	124	19	1,61	20	000960830
3,5	135	21	1,73	20	000960835
4	138	24	1,92	20	000960840
4,5	150	25	2,23	20	000960845
5	158	27	2,35	20	000960850
6	178	31	2,66	20	000960860
7	187	33	3,40	10	000960870
8	197	35	4,30	10	000960880
9	207	37	4,80	10	000960890
10	221	39	6,40	10	000960900
12	247	44	8,25	10	000960920



96L/SC8 2-2,5-3-4-5-6-8-10 mm	€ 26,50	1	000960924
96L/SCV	4,45	1	000960987



96L/SC12 2-2,5-3-3,5-4-4,5-5-6-7-8-9-10 mm	€ 39,50	1	000960929
96L/SCV12	5,30	1	000960978

96BP-CL

chiavi maschio esagonale piegate con estremità sferica, cromate colorate



mm	L mm	L1 mm	€		
1,5	91	16	3,05	5	000961600
2	102	17	3,40	5	000961601
2,5	113	21	3,75	5	000961602
3	128	23	4,20	5	000961603
4	143	28	4,65	5	000961604
5	163	33	5,05	5	000961605
6	185	37	6,45	5	000961606
8	206	43	8,80	2	000961608
10	231	50	11,60	2	000961610



96BP-CL/SC9 1,5-2-2,5-3-4-5-6-8-10 mm	€ 55,50	1	000961619
96BP-CL/SCV	4,45	1	000961629

96BPC

chiavi maschio esagonale piegate con estremità sferica, cromate

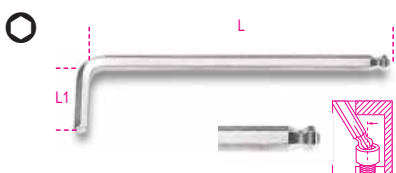

mm	L mm	L1 mm	€		
1,5	79	13	2,29	10	000960340
2	84	15	2,41	10	000960341
2,5	89	17	2,53	10	000960342
3	99	19	2,71	10	000960343
4	108	24	3,10	10	000960344
5	126	27	3,75	10	000960345
6	148	31	5,35	10	000960346
7	157	33	7,05	5	000960353
8	168	35	7,15	5	000960347
10	187	39	11,60	5	000960348
12	220	55	14,90	5	000960352



96BPC/SC9 1,5-2-2,5-3-4-5-6-8-10 mm	€ 45,50	1	000960354
96BPC/SCV	4,45	1	000960984

96BP

chiavi maschio esagonale piegate con estremità sferica, brunite



mm	L mm	L1 mm	€		
1,5	79	13	1,73	10	000960960
2	84	15	1,85	10	000960961
2,5	89	17	1,92	10	000960962
3	99	19	1,99	10	000960963
4	108	24	2,29	10	000960965
5	126	27	3,05	10	000960967
6	148	31	4,35	10	000960968
8	168	35	6,25	5	000960970
10	187	39	10,60	5	000960972
12	220	55	15,80	5	000960973



96BP/SC9 1,5-2-2,5-3-4-5-6-8-10 mm	€ 38,50	1	000960974
96BP/SCV	4,45	1	000960988

96LBP

chiavi maschio esagonale piegate con estremità sferica, modello extralungo, cromate

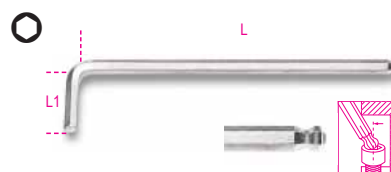

mm	L mm	L1 mm	€		
1,5	90	15	2,66	5	000961340
2	100	17	2,81	5	000961341
2,5	112	20	2,97	5	000961342
3	127	22	3,10	5	000961343
4	144	27	3,80	5	000961344
5	163	32	4,55	5	000961345
6	184	37	6,30	5	000961346
8	204	44	8,65	2	000961348
10	230	49	13,80	2	000961350



96LBP/SC9 1,5-2-2,5-3-4-5-6-8-10 mm	€ 53,00	1	000961354
96LBP/SCV	4,45	1	000961984

96BP/AS

chiavi maschio esagonale
piegate con estremità sferica, brunate



"	L mm	L1 mm	€		
3/32	89	17	2,10	10	000960989
1/8	98	18	2,23	10	000960990
5/32	108	24	2,66	10	000960991
3/16	126	26	3,05	10	000960992
7/32	139	28	4,40	10	000960993
1/4	152	31	4,80	10	000960994
5/16	168	34	6,35	5	000960995
3/8	190	39	10,50	5	000960996



96BP-AS/SC9	€ 41,50	1	000961000
1/16-3/32-1/8-5/32-3/16			
7/32-1/4-5/16-3/8			
96BP-AS/SCV	4,45	1	000961001



96BP-AS/8	€ 38,00	1	000960997
3/32-1/8-5/32-3/16-7/32			
1/4-5/16-3/8			
96BP-AS/BV	1,99	1	000960998

96BPA

chiavi maschio esagonale
piegate a 110° con estremità sferica,
modello lato extra corto, cromate



mm	L mm	L1 mm	€		
1,5	71	9	2,48	5	000961960
2	86	11	2,61	5	000961961
2,5	96	13	2,71	5	000961962
3	104	15	2,97	5	000961963
4	116	17	3,55	5	000961964
5	132	19	4,25	5	000961965
6	155	21	6,15	5	000961966
8	176	24	8,15	2	000961968
10	200	27	12,70	2	000961970



96BPA/SC9	€ 50,00	1	000961974
1,5-2-2,5-3-4-5-6-8-10 mm			
96BPA/SCV	4,45	1	000961988

96T

CHIAVI MASCHIO ESAGONALE

con impugnatura

Rapida e maneggevole

L'impugnatura compatta è perfettamente bilanciata per ruotare rapidamente nel palmo della mano.

La forma ergonomica permette di applicare coppie molto elevate.

Le estremità esagonali sono calibrate per trasmettere la massima coppia possibile alla vite.

La barra a sezione tonda ha una struttura più omogenea rispetto alla sezione esagonale e offre una maggiore resistenza.



Lama passante all'interno dell'impugnatura

96T

chiavi maschio esagonale piegate
con impugnatura di manovra

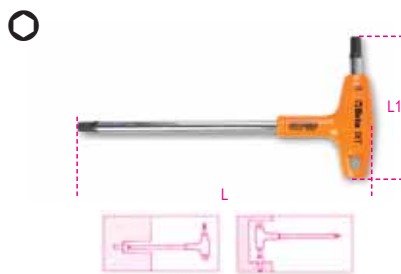

mm	L mm	L1 mm	€		
2	139	52	11,90	5	000960934
2,5	153	55	11,90	5	000960935
3	153	55	12,50	5	000960936
3,5	179	70	12,90	5	000960937
4	179	70	12,90	5	000960938
4,5	200	84	13,20	5	000960939
5	200	84	13,20	5	000960940
6	221	103	15,10	5	000960941
7	236	106	16,60	3	000960942
8	255	117	19,30	3	000960943
10	285	132	22,20	3	000960945



96T/S5P	€ 65,50	1	000960946
2,5-3-4-5-6			
96T/S6	77,50	1	000960952
2-2,5-3-4-5-6 mm			
96T/S8	119,00	1	000960933
2-2,5-3-4-5-6-8-10 mm			
96T/S11	161,50	1	000960951
2-2,5-3-3,5-4-4,5-5-6-7-8-10 mm			



96T/SP11	€ 201,50	1	000960957
2-2,5-3-3,5-4-4,5-5			
6-7-8-10 mm			
96T/SPV	45,00	1	000960958
96T/S11			
97TTX/S11			

96T/AS

chiavi maschio esagonale piegate
con impugnatura di manovra

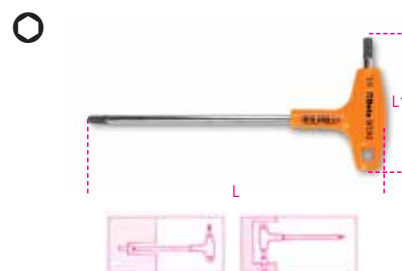

"	L mm	L1 mm	€		
3/32	153	55	14,80	2	000960669
7/64	153	55	14,80	2	000960670
1/8	179	70	15,00	2	000960671
9/64	179	70	15,70	2	000960672
5/32	200	84	15,70	2	000960673
3/16	200	84	15,70	2	000960674
7/32	221	103	17,50	2	000960675
1/4	236	106	19,50	2	000960676
5/16	255	117	22,20	2	000960678
3/8	285	132	26,50	2	000960680



96T/AS8	€ 144,00	1	000960682
3/32-7/64-1/8-5/32-3/16-			
1/4-5/16-3/8			
96T/AS10	177,50	1	000960683
3/32-7/64-1/8-9/64-5/32			
3/16-7/32-1/4-5/16-3/8			

96TBP

chiavi maschio esagonale piegate
con estremità sferica ed impugnatura
di manovra



mm	L mm	L1 mm	€	🔧	📦
2,5	153	55	12,50	3	000960685
3	153	55	13,10	3	000960686
4	179	70	13,80	3	000960687
5	200	84	14,40	3	000960688
6	221	103	15,70	3	000960689
8	255	117	20,80	2	000960690
10	285	132	22,20	2	000960692



96TBP/S6	90,50	1	000960694
-----------------	--------------	----------	------------------

2,5-3-4-5-6-8 mm

97TX

chiavi maschio piegate
per viti con impronta Torx®



mm	L mm	L1 mm	€	🔧	📦
T6	42	16	6,65	5	000970006
T7	48	16	6,65	5	000970007
T8	48	16	6,65	5	000970008
T9	48	16	7,30	5	000970009
T10	51	17	7,45	5	000970010
T15	54	18	7,45	5	000970015
T20	57	19	7,95	5	000970020
T25	60	20	8,15	5	000970025
T27	64	21	8,90	5	000970027
T30	70	24	8,90	5	000970030
T40	76	26	9,95	5	000970040
T45	83	29	11,90	5	000970045
T50	95	32	13,60	5	000970050
T55	108	35	17,30	5	000970055
T60	120	38	22,90	5	000970060



97TX/ST8	71,50	1	000970640
-----------------	--------------	----------	------------------

T9-T10-T15-T20-T25
T27-T30-T40



97TX/G8	56,00	1	000970645
----------------	--------------	----------	------------------

T9-T10-T15-T20-T25
T27-T30-T40



97TX/BG8	44,50	1	000970368
-----------------	--------------	----------	------------------

T9-T10-T15-T20-T25-T27-T30-T40



97TX/SC8	70,50	1	000970064
-----------------	--------------	----------	------------------

T9-T10-T15-T20-T25
T27-T30-T40

97TX/SCV	4,45	1	000970985
-----------------	-------------	----------	------------------



97TX/B13	113,50	1	000970650
-----------------	---------------	----------	------------------

T6-T7-T8-T9-T10-T15-T20
T25-T27-T30-T40-T45-T50

96N/BV	1,99	1	000960651
---------------	-------------	----------	------------------

97BTX

chiavi maschio piegate
con un'estremità sferica
per viti con impronta Torx®

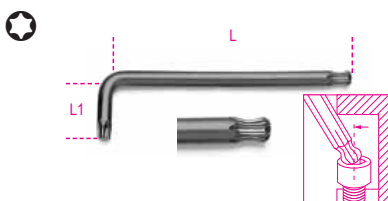

mm	L mm	L1 mm	€	🔧	📦
T9	62	16	8,45	5	000970109
T10	71	17	8,45	5	000970110
T15	81	18	8,45	5	000970115
T20	92	19	9,10	5	000970120
T25	94	20	9,70	5	000970125
T27	105	21	10,30	5	000970127
T30	114	24	10,40	5	000970130
T40	129	26	12,00	5	000970140
T45	133	28	14,10	5	000970145



97BTX/SC8	81,50	1	000970164
------------------	--------------	----------	------------------

T9-T10-T15-T20-T25-T27-T30-T40

97BTX/SCV	4,45	1	000970983
------------------	-------------	----------	------------------



97BTX/B8	79,00	1	000970159
-----------------	--------------	----------	------------------

T9-T10-T15-T20-T25
T27-T30-T40

96N/BV	1,99	1	000960651
---------------	-------------	----------	------------------

97BTX-C

chiavi maschio piegate
con un'estremità sferica
per viti con impronta Torx®
colorate



mm	L mm	L1 mm	€	🔧	📦
T9	80	16	9,35	5	000971609
T10	86	17	9,35	5	000971610
T15	90	18	9,35	5	000971615
T20	95	19	10,20	5	000971620
T25	100	20	10,90	5	000971625
T27	105	21	11,50	5	000971627
T30	114	24	11,90	5	000971630
T40	124	26	13,10	5	000971640



97BTX-C/SC8	90,00	1	000971658
--------------------	--------------	----------	------------------

T9-T10-T15-T20-T25-T27-T30-T40

97BTX-C/SCV	4,45	1	000971659
--------------------	-------------	----------	------------------



97BTXL

chiavi maschio piegate con un'estremità sferica, modello lungo, per viti con impronta Torx®



	L mm	L1 mm	€		
T9	80	15	8,90	3	000970309
T10	86	17	8,90	3	000970310
T15	100	18	8,90	3	000970315
T20	110	19	10,20	3	000970320
T25	126	20	11,20	3	000970325
T27	140	24	12,60	3	000970327
T30	160	28	13,10	3	000970330
T40	176	32	15,60	3	000970340



	€		
97BTXL/SC8 T9-T10-T15-T20- T25-T27-T30-T40	94,00	1	000970364
97BTXL/SCV	4,45	1	000970982

97RTX

chiavi maschio piegate per viti con impronta Tamper Resistant Torx®



	L mm	L1 mm	€		
T6	40	15	8,05	5	000970206
T7	45	15	8,05	5	000970207
T8	50	16	8,05	5	000970208
T9	56	16	8,05	5	000970209
T10	62	17	8,05	5	000970210
T15	72	17	8,05	5	000970215
T20	83	18	8,25	5	000970220
T25	90	18	8,50	5	000970225
T27	100	20	9,55	5	000970227
T30	105	24	9,65	5	000970230
T40	112	26	10,60	5	000970240
T45	118	26	12,50	5	000970245
T50	122	28	16,10	3	000970250
T55	128	30	18,50	3	000970255



	€		
97RTX/SC8 T9-T10-T15-T20-T25 T27-T30-T40	75,00	1	000970263
97RTX/SCV	4,45	1	000970984



	€		
97RTX/B8 T9-T10-T15-T20-T25 T27-T30-T40	72,50	1	000970260
96N/BV	1,99	1	000960651

97BRTXL/SC8

serie di 8 chiavi maschio piegate con un'estremità sferica, modello lungo per viti con impronta Tamper Resistant Torx®



	€		
97BRTXL/SC8 T9-T10-T15-T20- T25-T27-T30-T40	95,00	1	000970464
97BRTXL/SCV	4,45	1	000970986

97TTX

chiavi maschio piegate con impugnatura per viti con impronta Torx®

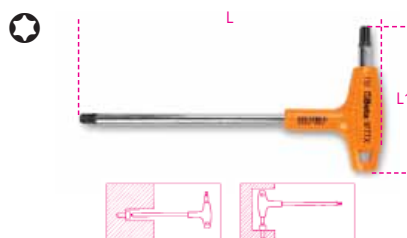

	L mm	L1 mm	€		
T6	130	52	12,30	3	000970706
T7	130	52	12,30	3	000970707
T8	139	52	12,40	3	000970708
T9	139	52	12,40	3	000970709
T10	179	70	12,70	3	000970710
T15	179	70	13,70	3	000970715
T20	179	70	14,20	3	000970720
T25	179	70	15,10	3	000970725
T27	200	84	16,60	3	000970727
T30	200	84	17,20	3	000970730
T40	221	103	20,40	3	000970740
T45	236	106	23,90	2	000970745
T50	255	117	30,50	2	000970750



	€		
97TTX/S6 T10-T15-T20-T25-T30-T40	93,50	1	000970791
97TTX/S8 T8-T10-T15-T20-T25- T27-T30-T40	122,50	1	000970808
97TTX/S11 T8-T9-T10-T15-T20-T25 T27-T30-T40-T45-T50	189,00	1	000970800
97TTX/S13 T6-T7-T8-T9-T10-T15-T20-T25 T27-T30-T40-T45-T50	213,50	1	000970813



	€		
97TTX/SP11 T8-T9-T10-T15-T20-T25 T27-T30-T40-T45-T50	229,00	1	000970840
96T/SPV 96T/S11 97TTX/S11	45,00	1	000960958

98XZN

chiavi a profilo XZN®



DIN 65253

	L mm	L1 mm	€		
M5	83	25	5,75	5	000980005
M6	89	30	6,60	5	000980006
M8	97	32	8,35	5	000980008
M10	106	35	11,00	5	000980010
M12	116	37	13,90	5	000980012



	€		
98XZN/B5 M5-M6-M8-M10-M12	47,50	1	000980650
96N/BV	1,99	1	000960651

99

chiavi a settore con nasello quadro per ghiera



UNI 6752

	mm	A mm	€		
12-14	1,5		11,10	3	000990012
16-18-20	1,8		11,10	3	000990016
22-25-28	1,8		14,80	3	000990022
30-32	2,1		14,80	3	000990030
34-36-38	2,4		18,00	3	000990034
40-42	2,4		18,00	3	000990040
45-50	2,5		22,30	3	000990045
52-55-58	2,5		22,30	3	000990052
62-65	3,1		28,00	3	000990062
68-70-75	3,1		28,00	3	000990068
80-85-90	3,8		37,50	2	000990080
92-95	4,3		37,50	2	000990092
98-100	4,3		37,50	2	000990098
105-110-115	4,4		59,50	1	000990105
120-125-130	4,9		59,50	1	000990120
135-145	6,0		87,50	1	000990135
155-165	6,0		87,50	1	000990155

99SQ

chiavi a settore articolate
con nasello quadro



Ø mm	B mm	€	🔧	📦
15-35	2,7	30,00	2	000990215
35-50	3,5	34,00	2	000990235
50-80	4,7	44,50	2	000990250
80-120	6,2	61,00	2	000990280
120-180	7,8	81,50	2	000990290

99ST

chiavi a settore articolate
con nasello tondo



Ø mm	Ø mm	B mm	€	🔧	📦
15-35	3,0	2,5	30,50	2	000990315
35-50	4,0	4,5	36,00	2	000990335
50-80	5,0	5,0	48,00	2	000990350
80-120	6,0	7,0	65,50	2	000990380
120-180	8,0	9,0	85,00	2	000990390

99 VN/...

nasello di ricambio per 99ST

	Ø mm	€	🔧	📦
99ST VN/15	15-35	8,40	1	000990295
99ST VN/35	35-50	9,65	1	000990296
99ST VN/50	50-80	11,90	1	000990297
99ST VN/80	80-120	13,70	1	000990298
99ST VN/120	120-180	18,00	1	000990299

100

chiave a compasso con naselli tondi



Ø mm	L mm	Ø min-max mm	€	🔧	📦
4,8-5,8 6,9-7,9	250	18÷100	156,50	1	001000001

100/KIT

naselli di ricambio per art. 100

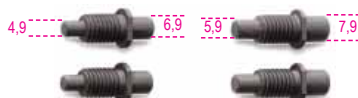

	€	🔧	📦
100/KIT	48,00	1	001000010

111E CHIAVI REGOLABILI A RULLINO

Le nuove chiavi a rullino **Beta 111E** consentono di avvitare e svitare dadi e bulloni di diverse dimensioni grazie alla ganaschia mobile, regolabile tramite il rullino posto al centro.

Testa inclinata di **15°** per manovrare anche negli spazi più difficili come le nostre iconiche chiavi combinate "42".



Apertura
della chiave
maggiorata.
Ingombro ridotto
della testa a
ganaschia
completamente
aperta.

Doppia marcatura
al laser in mm/pollici

Lo studio della nuova ergonomia ha permesso di avere un riduzione di peso del 20%.

Realizzata in acciaio legato ad alte prestazioni per un'**elevata resistenza** meccanica alle torsioni. Trattamenti termici dedicati per un'ottima resistenza all'usura. Foro su impugnatura per appendere la chiave.

111E

chiavi regolabili a rullino cromate
con scala graduata

- Rotazione destrorsa del rullino
- Scala in millimetri e in pollici



DIN 3117 ISO 6787

L mm	L "	A max mm	€	🔧	📦
100	4	15	26,00	3	001110110
150	6	24	27,00	3	001110115
200	8	29	33,00	3	001110120
250	10	34	40,00	3	001110125
300	12	40	53,00	3	001110130
380	15	45	104,00	3	001110138
450	18	54	173,00	2	001110145
600	24	62	239,50	1	001110160

111EN

chiavi regolabili a rullino fosfatate con scala graduata

- Rotazione sinistrorsa del rullino
- Scala in millimetri e in pollici



DIN 3117 ISO 6787

L mm	L "	A max mm	€	🔧	📦
100	4	15	23,80	3	001110410
150	6	24	24,90	3	001110415
200	8	29	29,00	3	001110420
250	10	34	36,00	3	001110425
300	12	40	48,50	3	001110430
380	15	45	96,00	3	001110438
450	18	54	163,50	2	001110445

111ER

chiavi regolabili a rullino cromate
con scala graduata a ganaschia reversibile

- Ganaschia reversibile
- Rotazione destrorsa del rullino
- Scala in millimetri e in pollici



L mm	L "	A max mm	Ø max "	€	🔧	📦
200	8	29	3/4	34,50	3	001110520
250	10	34	1	42,50	3	001110525
300	12	40	1.1/4	55,50	2	001110530

111CM

chiavi regolabili a rullino cromate corte
con apertura maggiorata

- Apertura maggiorata
- Rotazione destrorsa
- Scala in millimetri e in pollici



L mm	L "	A max mm	€	🔧	📦
170	6	32	39,50	2	001110770
220	8	38	48,00	3	001110722
270	10	46	63,50	3	001110727

120

chiavi poligonali aperte a cricchetto

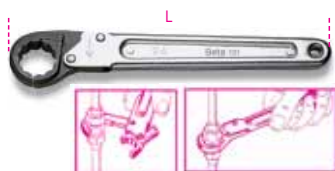

mm	L mm	€		
10	135	49,50	1	001200010
11	135	49,50	1	001200011
12	135	49,50	1	001200012
13	135	49,50	1	001200013
14	135	56,00	1	001200014
17	185	60,50	1	001200017
19	185	64,50	1	001200019
22	230	87,50	1	001200022
24	230	94,00	1	001200024
27	230	119,50	1	001200027
30	320	135,50	1	001200030
32	320	143,50	1	001200032



120/B6N	373,00	1	001200060
10-11-13			
17-19-22 mm			
2002/BVL6	11,60	1	020020010

123E1/4

adattatore portainserti 1/4" per chiavi a cricchetto 10 mm



mm	L mm	€		
10	20,6	6,50	1	001230010

123Q1/4

adattatore a sgancio rapido 1/4" per chiavi a cricchetto 10 mm



mm	L mm	€		
10	17,5	9,00	1	001230310

123Q3/8

adattatore a sgancio rapido 3/8" per chiavi a cricchetto 13 mm



mm	L mm	€		
13	22,5	9,10	1	001230313

123Q1/2

adattatore a sgancio rapido 1/2" per chiavi a cricchetto 19 mm



mm	L mm	€		
19	30,5	9,70	1	001230319

123/K4

kit di 4 adattatori per chiavi a cricchetto: 1 adattatore per bits 3 adattatori a sgancio rapido



123/K4	34,50	1	001230504
--------	-------	---	-----------

141

chiavi combinate dirette a cricchetto



ISO 21982:2020

mm	L mm	€		
8x8	136	16,30	3	001410008
9x9	143	17,00	3	001410009
10x10	160	17,50	3	001410010
11x11	168	17,80	3	001410011
12x12	174	18,50	3	001410012
13x13	180	20,10	3	001410013
14x14	193	21,00	2	001410014
15x15	200	21,90	2	001410015
16x16	216	24,00	2	001410016
17x17	233	24,90	2	001410017
18x18	239	26,00	2	001410018
19x19	250	26,50	2	001410019



141/B6	135,50	1	001410066
8-10-13-14-17-19 mm			
141/B9	195,50	1	001410069
8-10-11-12-13-14-15-17-19 mm			



141/S12	251,00	1	001410072
8-9-10-11-12-13-14-15-16-17-18-19 mm			

142

CHIAVI A CRICCHETTO

La rapidità del cricchetto a 72 denti offre un angolo di ripresa di soli 5° e permette serraggi veloci e precisi.

1 La bocca fissa permette forti serraggi grazie alla lunghezza elevata del gambo.

2 L'invertitore è incassato per evitare i rischi di inversione accidentale.

3 L'occhio poligonale è inclinato di 15° per proteggere la mano e consentire una migliore accessibilità

4 La testa a bocca fissa è inclinata di 15° rispetto all'asse per ridurre l'angolo di ripresa.



142

chiavi combinate a cricchetto reversibile



ISO 21982:2020

mm	L mm	€		
6x6	136	17,80	3	001420006
7x7	136	17,80	3	001420007
8x8	136	18,40	3	001420008
9x9	143	19,70	3	001420009
10x10	159	20,20	3	001420010
11x11	168	20,90	3	001420011
12x12	174	21,60	3	001420012
13x13	180	23,30	3	001420013
14x14	190	24,00	2	001420014
15x15	200	25,50	2	001420015
16x16	216	27,50	2	001420016
17x17	233	28,50	2	001420017
18x18	239	30,50	2	001420018
19x19	248	31,00	2	001420019
21x21	285	40,00	1	001420021
22x22	285	41,50	1	001420022
24x24	325	48,00	1	001420024
27x27	355	69,50	1	001420027
30x30	420	81,50	1	001420030
32x32	420	84,50	1	001420032
34x34	482	118,00	1	001420034
36x36	482	119,00	1	001420036
38x38	482	121,50	1	001420038



142/B6	€ 154,50	1	001420066
8-10-13-14-17-19 mm			
142/BV6	9,00	1	001420076
142/B9	224,00	1	001420069
8-10-11-12-13-14-15-17-19 mm			
142/BV9	10,80	1	001420079



142/S15	€ 368,00	1	001420074
6-7-8-9-10-11-12-13			
14-15-16-17-18-19-22 mm			
142/S17	506,00	1	001420068
6-7-8-10-11-12-13-14-15-			
16-17-18-19-21-22-24-27 mm			
142/S19	652,00	1	001420075
6-7-8-9-10-11-12			
13-14-15-16-17-18			
19-22-24-27-30-32 mm			

142/SC9I-E

serie di 9 chiavi combinate a cricchetto reversibile con supporto compatto



142/SC9I	€ 222,00	1	001420087
8-10-11-12-13-14-15-17-19 mm			
142/SCV9I	10,50	1	001420103
142/SC9E	230,50	1	001420088
8-10-11-12-13-16-17-18-19 mm			
142/SCV9E	10,50	1	001420104

142MC

chiavi combinate a cricchetto reversibile colorate



ISO 21982:2020

mm	L mm	€		
8x8	136	19,40	3	001422008
10x10	159	21,20	3	001422010
11x11	168	21,70	3	001422011
12x12	174	22,70	3	001422012
13x13	180	24,30	3	001422013
14x14	190	25,50	2	001422014
15x15	200	26,50	2	001422015
16x16	216	29,50	2	001422016
17x17	233	30,00	2	001422017
18x18	239	31,50	2	001422018
19x19	248	32,50	2	001422019



142MC/SC9I	€ 232,50	1	001422087
8-10-11-12-13-14-15-17-19 mm			
142MC/SC9E	241,50	1	001422088
8-10-11-12-13-16-17-18-19 mm			

142AS

chiavi combinate a cricchetto reversibile



mm	L mm	€		
5/16x5/16	136	21,70	2	001420308
3/8x3/8	159	22,20	2	001420310
7/16x7/16	168	23,50	2	001420311
1/2x1/2	180	26,50	2	001420313
9/16x9/16	190	27,00	2	001420314
5/8x5/8	216	30,00	2	001420316
11/16x11/16	233	30,50	2	001420317
3/4x3/4	248	33,50	2	001420319



142AS/8	€ 215,00	1	001420330
5/16-3/8-7/16-1/2			
9/16-5/8-11/16-3/4			

142C

chiavi combinate corte diritte a cricchetto



ISO 21982:2020

mm	L mm	€		
8x8	88	13,30	2	001420108
9x9	96	13,30	2	001420109
10x10	96	13,80	2	001420110
11x11	100	14,70	2	001420111
12x12	104	15,60	2	001420112
13x13	108	16,30	2	001420113
14x14	114	17,00	2	001420114
15x15	118	17,60	2	001420115
16x16	122	18,10	2	001420116
17x17	128	19,70	2	001420117
18x18	132	21,20	2	001420118
19x19	138	21,70	2	001420119



142C/A12	€ 229,00	1	001420175
8-9-10-11-12-13-14			
15-16-17-18-19 mm			

142SN

chiavi combinate a cricchetto snodate



ISO 21982:2020

mm	L mm	€		
7x7	136	21,40	2	001420207
8x8	136	22,20	2	001420208
9x9	143	23,20	2	001420209
10x10	160	24,40	2	001420210
11x11	168	25,50	2	001420211
12x12	174	26,50	2	001420212
13x13	180	28,50	2	001420213
14x14	193	29,50	2	001420214
15x15	200	31,00	2	001420215
16x16	216	33,00	2	001420216
17x17	233	33,50	2	001420217
18x18	239	36,00	2	001420218
19x19	250	36,50	2	001420219
22x22	285	43,50	1	001420222
24x24	325	48,50	1	001420224



142SN/S13	€ 371,00	1	001420263
7-8-9-10-11-12-13-14			
15-16-17-18-19 mm			



142SN/SC9	€ 266,00	1	001420259
8-10-11-12-13-14-15-17-19 mm			

186

chiave autoserrante a ripresa automatica per esagoni da 8 a 32 mm

ideale per viti con testa a profilo: esagonale, Spline®, quadrato, Torx®; anche rovinate.



L mm	€	1	001860008
260	50,50	1	001860008

187

chiavi esagonali apribili snodate



mm	L mm	€	1	001870008
8x9	125	34,50	1	001870008
10x11	155	37,00	1	001870010
12x13	175	38,00	1	001870012
14x15	205	42,00	1	001870014
16x17	235	47,50	1	001870016



187/B5	€	1	001870050
8x9-10x11-12x13 14x15-16x17 mm	210,00	1	001870050

188

chiavi poligonali diritte e a cricchetto per pulegge libere alternatori



mm	L mm	€	2	001880010
10	240	22,90	2	001880010
15	322	31,50	2	001880015

192

chiavi poligonali doppie diritte a cricchetto reversibile 4 in 1



mm	L mm	€	1	001920008
8x10/12x13	160	29,50	1	001920008
16x17/18x19	230	37,50	1	001920016



192/S2	€	1	001920070
8x10/12x13 mm 16x17/18x19 mm	67,00	1	001920070

194

chiave portainserti a cricchetto reversibile



1/4x5/16	L mm	€	2	001940006
128	37,50	2	001940006	

195

chiavi poligonali doppie diritte a cricchetto



mm	L mm	€	2	001950010
8x10	128	20,50	2	001950010
12x13	170	23,50	2	001950013
14x15	190	24,60	2	001950015
16x18	230	29,00	2	001950018
17x19	230	30,50	2	001950019



195/B5	€	1	001950066
8x10-12x13-14x15 16x18-17x19 mm	139,00	1	001950066

195AS

chiavi poligonali doppie diritte a cricchetto



mm	L mm	€	2	001950606
5/16x3/8	128	21,20	2	001950606
7/16x1/2	170	23,50	2	001950611
9/16x5/8	190	26,50	2	001950614
11/16x3/4	230	30,00	2	001950617



195AS/B4	€	1	001950654
5/16x3/8 - 7/16x1/2 - 9/16x5/8 - 11/16x3/4	112,00	1	001950654

195P

chiavi poligonali doppie piegate a 15° a cricchetto reversibile



mm	L mm	€	2	001950210
8x10	128	31,00	2	001950210
12x13	170	33,00	2	001950213
14x15	190	34,00	2	001950215
16x18	230	38,00	2	001950218
17x19	230	40,00	2	001950219



195P/B5	€	1	001950266
8x10-12x13-14x15 16x18-17x19 mm	187,00	1	001950266

195/BV5	€	1	001950070
	10,80	1	001950070

310

polifusori per saldatura tubi e raccordi in materiale plastico PE, PP, PVC e PVDF



310/2	€	1	003100002
230V-650 Watt 50 Hz±60Hz Schuko (CEE 7/7)	402,00	1	003100002

310B

matrici per polifusore 310



mm	€	1	003100016
16	68,50	1	003100016
20	75,00	1	003100020
25	80,50	1	003100025
32	89,00	1	003100032
40	105,00	1	003100040
50	133,00	1	003100050
63	153,00	1	003100063



310/C8

polifusore con assortimento di 7 matrici



310/C8

310/2+310B: Ø 16-20-25
32-40-50-63

€ 902,00

1 003100108

440x270x120 mm - 7,7 kg

311

termopiastre per saldatura tubi in materiale plastico PE

CE



230V
50 Hz+60Hz

Schuko (CEE 7/7)

	Ø mm	Watt	€		
311/1	120	300	358,00	1	003110001
311/2	190	900	398,00	1	003110002

CAMPO DI IMPIEGO DEI TAGLIATUBI BETA

I tagliatubi Beta coprono un campo di applicazione molto ampio. Consentono di effettuare tagli precisi e puliti su tutti i materiali impiegati per le tubature, grazie alla precisione e alla scorrevolezza dei rulli e dell'avanzamento che può essere a vite o telescopico.

Nella tabella seguente è possibile trovare l'associazione tra tagliatubi e coltello per ogni materiale.

	TUBI GAS ACCIAIO			TUBI GAS ACCIAIO INOX		
	10 mm	60 mm	115 mm	10 mm	60 mm	115 mm
	1/8"	2"	4"	1/8"	2"	4"
330/2						
330/4						
				330/2+330R/12		
				330/4+330R/14		

	TUBI IN RAME E LEGHE LEGGERE							
	3 mm	6 mm	8 mm	16 mm	28 mm	30 mm	38 mm	67 mm
	1/8"	1/4"	5/16"	5/8"	1"1/8"		1"1/2"	2"5/8"
332								
334								
336								
338								

	TUBI IN ACCIAIO INOX A PARETE SOTTILE							
	3 mm	6 mm	8 mm	16 mm	28 mm	30 mm	38 mm	67 mm
	1/8"	1/4"	5/16"	5/8"	1"1/8"		1"1/2"	2"5/8"
332 + 334R/I								
334 + 334R/I								
336 + 338R/I								
338 + 338R/I								

	TUBI IN PLASTICA							
	6 mm	8 mm	16 mm	30 mm	38 mm	50 mm	67 mm	127 mm
	1/4"	5/16"	5/8"	1"1/8"	1"1/2"	2"	2"5/8"	5"
336 + 338RP								
338 + 338RP								
339A								

330

tagliatubi per tubi gas in acciaio



	Ø mm -"	L mm	€		
330/2	10÷60 1/8"÷2"	380	170,50	1	003300002
330/4	60÷115 2"÷4"	585	388,00	1	003300004

330R/A

coltelli di ricambio per 330 per tubi in acciaio



	Ø mm	S mm	€		
330R/A2	32	7	16,40	1	003300012
330R/A4	42	9	42,50	1	003300014

330R/I

coltello di ricambio per 330 per acciaio INOX



	Ø mm	S mm	€		
330R/I2	32	7	36,50	1	003300024
330R/I4	32	9	102,50	1	003300034

331C

tagliatubi tascabile a c per rame e leghe leggere



	Ø mm	L mm	€		
15÷22	15÷22	78	60,50	1	003310050

332

mini-tagliatubi per rame e leghe leggere



Ø mm - "	L mm	€		
3÷16 1/8"÷5/8"	59	24,60	2	003320001
3÷28 1/8"÷1"1/8"	63	27,50	2	003320003

334

tagliatubi per rame e leghe leggere



Ø mm - "	L mm	€		
3÷30 1/8"÷1"1/8"	150	34,00	1	003340001

334R

coltello di ricambio per 332-334 per rame e leghe leggere



Ø mm	€		
334R 18	7,25	1	003340021

334R/I

coltello di ricambio per 332-334 per acciaio INOX



Ø mm	€		
334R/I 18	20,60	1	003340023

336

tagliatubi ad avanzamento telescopico per rame e leghe leggere



Ø mm - "	L mm	€		
6÷38 1/4"÷1"1/2"	160	56,00	1	003360001

338

tagliatubi ad avanzamento telescopico rapido per rame, leghe leggere e plastica



Ø mm - "	L mm	€		
6÷67 1/4"÷2"5/8"	290	139,50	1	003380001

338R

coltello di ricambio per 331L, 336 e 338 per rame e leghe leggere



Ø mm	€		
338R 18,5	7,70	1	003380022

338R/I

coltello di ricambio per 336 e 338 per acciaio INOX

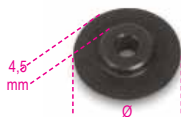

Ø mm	€		
338R/I 21,8	22,90	1	003380023

338RP

coltello di ricambio per 336 e 338 per plastica



Ø mm	€		
338RP 21,9	8,35	1	003380025

339A

tagliatubi ad avanzamento telescopico rapido per tubi di plastica



Ø mm - "	L mm	€		
50÷127 2"÷5"	345	298,00	1	003390011

339A/R

coltelli di ricambio per 339A



Ø mm	€		
339A/R 42	20,60	1	003390061

340

pinza tagliatubi per tubi multistrato

lama rivestita in PTFE
4 rulli di appoggio per facilitare la rotazione del tubo durante il taglio
sistema per il taglio dei tubi corrugati integrato nel manico
corpo leggero in magnesio



Ø max mm	€		
340 26	116,00	1	003400001

340RL

lama di ricambio per 340



€		
340RL 33,00	1	003400010

340C

pinza tagliatubi per tubi corrugati

- pinza in lega di alluminio e magnesio
- compatta, tascabile e leggera
- seconda lama accessoria per il taglio longitudinale



∅	L	€		
mm	mm			
14-45	134	55,00	1	003400050

340C/KRL

kit 3 lame di ricambio per 340C



€			
33,00	1	003400055	

341

pinza tagliatubi per tubi in materiale plastico



∅	L	€		
mm	mm			
0÷25	190	41,50	1	003410001

341RL

lama di ricambio per 341



€			
18,60	1	003410010	

341B

cesoia a cricchetto per tubi in materiale plastico



∅	L	€		
mm	mm			
0÷35	195	76,00	1	003410051

341B/RM

molla di ricambio per 341B

€			
2,85	1	003410061	

341B/RL

lama di ricambio per 341B



€			
28,50	1	003410060	

342

cesoia a cricchetto per tubi in materiale plastico



∅	L	€		
mm - "	mm			
0÷42	200	55,50	1	003420030
1"5/8				

342MOL

molla di ricambio per 342

€			
4,05	1	003420033	

342RL

lama di ricambio per 342



€			
25,50	1	003420032	

342A

cesoia a cricchetto per tubi in materiale plastico



∅	L	€		
mm - "	mm			
0÷50	270	113,50	1	003420101
2"				

342A/MOL

molla di ricambio per 342A

€			
2,46	1	003420111	

342A/RL

lama di ricambio per 342A



€			
59,00	1	003420110	

342P

cesoia a cricchetto in lega di magnesio per tubi in materiale plastico



∅	L	€		
mm - "	mm			
0÷50	260	123,00	1	003420121
2"				

342P/RL

lama di ricambio per 342P



€			
51,50	1	003420130	



345

utensile sbavatubi
corpo in metallo



Ø	L	€	Icon	Code
mm - "	mm			
3÷42	58	30,00	5	003450001
1/8"÷1"5/8				

345U

utensile sbavatubi per inox, acciaio, rame e leghe leggere



Ø	L	€	Icon	Code
mm - "	mm			
4÷36	60	79,00	1	003450050
5/32÷1"7/16				

345U/A

adattatore per sbavatubi 345U
attacco esagonale 1/4" per avvitatori



L	€	Icon	Code
mm			
90	20,10	3	003450055

345C

calibratore per tubi multistrato



Ø	€	Icon	Code
mm			
16-20-26-32	47,50	1	003450032

345SB

sbavatore a raschietto
a lama intercambiabile girevole



L	€	Icon	Code
mm			
150	24,60	5	003450010

345SB/R

lama di ricambio per 345SB



L	€	Icon	Code
mm			
345SB/R	8,70	3	003450015

345SB2

sbavatore a raschietto
a lama fissa



L	€	Icon	Code
mm			
140	12,30	5	003450022

345SC

scovolino 4 in 1
per diametri interni ed esterni
da 1/2" e da 3/4"



L	L1	L2	€	Icon	Code
mm	mm	mm			
195	28	32	14,40	2	003450060

345SI

sbavatore per interni
a lama intercambiabile girevole



L	Ø	€	Icon	Code
mm	mm			
168	16,5	47,00	1	003450040

345SI/R

lama di ricambio per 345SI



L	€	Icon	Code
mm			
345SI/R	32,50	1	003450045

349

attrezzo bordatubi con frizione per rame e leghe leggere



Ø	€	Icon	Code
mm - "			
6-8-10-12-14-15-16-18 (1/8-3/16-1/4-5/16 3/8-1/2-5/8-3/4)	296,00	1	003490001

270x200x50 mm - 2,7 kg

349/SMM

slitta metrica per 349



Ø	€	Icon	Code
mm			
6-8-10-12-14-15-16-18	87,00	1	003490011

349/SMAS

slitta in pollici per 349



Ø	€	Icon	Code
"			
1/8-3/16-1/4-5/16 3/8-1/2-5/8-3/4	82,00	1	003490012

350

attrezzo bordatubi
per rame e leghe leggere

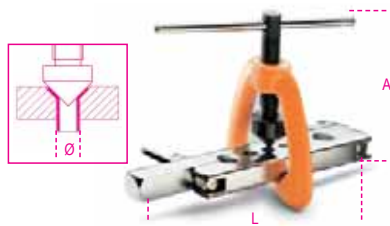

∅ mm	L mm	A mm	€	🔧	📦
4-4,75-6-8	175	104	86,00	1	003500001
10-12-14					

351C

tagliatubi ed attrezzo bordatubi



351C	€	🔧	📦
	155,50	1	003510010

334	∅ 3+30 mm (1/8"÷1"1/8)
350	∅ 4÷14 mm
351P	∅ 4-4,75-6-8-10-12-14 mm

📏 225x150x45 mm - 🏠 1,6 kg

351P

puntali per 350



351P	∅ mm	€	🔧	📦
351P 4	4	7,10	3	003510101
351P 4,75	4,75	7,10	3	003510102
351P 6	6	7,10	3	003510103
351P 8	8	7,10	3	003510104
351P 10	10	7,10	3	003510105
351P 12	12	7,10	3	003510106
351P 14	14	7,10	3	003510107

352U

attrezzo bordatubi regolabile,
per rame e leghe leggere

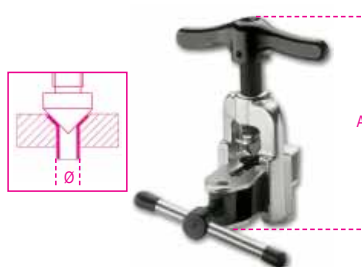

∅ mm - "	A mm	€	🔧	📦
5÷16	130	102,00	1	003520101
3/16÷5/8				

352C/U

tagliatubi, sbavatore
ed attrezzo bordatubi regolabile



352C/U	€	🔧	📦
	200,50	1	003520110

334	∅ 3+30 mm (1/8"÷1"1/8)
345SB	
352U	∅ 5÷16 mm (3/16"÷5/8")

📏 335x145x60 mm - 🏠 2120 g

355

chiave per raccordi radiatori
a cinque gradazioni



∅ "	L mm	€	🔧	📦
3/8"-1/2"	90	40,50	2	003550001
3/4"-1"				

357F3

dima a tre file
per installazione attacchi sanitari

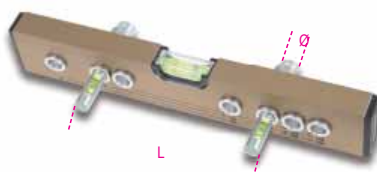

∅ "	L mm	€	🔧	📦
3/8" / 1/2"	90÷220	128,50	1	003570100

357R/F3

fiala di ricambio per 357F3



357R/F3	€	🔧	📦
	20,70	1	003570101

358

attrezzi per smussare esternamente
tubi in materiale plastico



	∅ mm	€	🔧	📦
358/1	16÷110	181,00	1	003580001
358/2	40÷250	181,00	1	003580002

358RL

lama di ricambio per 358/1 e 358/2



358RL	€	🔧	📦
	33,50	1	003580011

359

chiave universale per pilette



∅ "	L mm	A mm	€	🔧	📦
1"÷1"1/4	160	140	89,00	1	003590001

Beta

359CH

adattatore per pilette
con grata a croce per 359



Ø	L	€		
mm	mm			
1"1/2	74	50,50	1	003590005

360

giratubi modello stillson



L	Ø	Ø	€		
mm	max "	max mm			
250	1" gas	34	37,00	1	003600025
350	1"1/2 gas	49	49,00	1	003600035
450	2" gas	60	68,50	1	003600045
600	2"1/2 gas	76	105,00	1	003600060
900	3"1/2 gas	102	291,00	1	003600090

360R/...

kit ricambio per 360
composto da ganascia mobile e ghiera.

	€		
360R 250	13,80	1	003600225
360R 350	19,00	1	003600235
360R 450	27,50	1	003600245
360R 600	40,50	1	003600260
360R 900	72,50	1	003600290

361N

giratubi regolabile a leva



L	Ø	Ø	€		
mm	max "	max mm			
350	1" 1/2	49	76,50	1	003610014

362

giratubi modello americano



L	Ø	Ø	€		
mm	max "	max mm			
200	1" gas	34	32,50	1	003620020
250	1"1/2 gas	49	41,00	1	003620025
300	2" gas	60	49,00	1	003620030
350	2" gas	60	58,50	1	003620035
450	2"1/2 gas	76	84,50	1	003620045
600	3" gas	90	128,00	1	003620060
900	5" gas	140	157,00	1	003620090

362R/...

kit ricambi per 362
composto da: ganascia fissa; ganascia mobile;
ghiera; spina di fissaggio.

	€		
362R 200	6,80	1	003620220
362R 225	9,70	1	003620225
362R 300	12,00	1	003620230
362R 350	13,80	1	003620235
362R 450	18,90	1	003620245
362R 600	25,50	1	003620260
362R 900	63,00	1	003620290

363

giratubi modello americano
corpo in lega leggera



L	Ø	Ø	€		
mm	max "	max mm			
350	2" gas	60	70,50	1	003630035
450	2"1/2 gas	76	95,00	1	003630045
600	3" gas	90	160,50	1	003630060
900	5" gas	140	301,00	1	003630090
1200	6" gas	165	319,00	1	003630120

363R/...

kit ricambi per 363
composto da: ganascia fissa; ganascia mobile;
ghiera; spina di fissaggio.

	€		
363R 350	15,20	1	003630235
363R 450	20,20	1	003630245
363R 600	28,00	1	003630260
363R 900	55,00	1	003630290
363R 1200	85,00	1	003630320

365

giratubi modello frontale
corpo in lega leggera

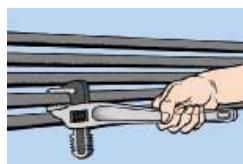

L	Ø	Ø	€		
mm	max "	max mm			
350	2" gas	60	88,00	1	003650035
450	2"1/2 gas	76	121,00	1	003650045

365R/...

kit ricambi per 365
composto da: ganascia fissa; ganascia mobile;
ghiera; spina di fissaggio.

	€		
365R 350	66,00	1	003650235
365R 450	98,50	1	003650245

366

giratubi tipo leggero



L	Ø	Ø	€		
mm	max "	max mm			
175	1" gas	34	33,50	1	003660017
225	1"1/2 gas	49	39,50	1	003660022
275	2" gas	60	48,00	1	003660027
300	2"1/2 gas	76	52,00	1	003660030
350	3" gas	90	58,50	1	003660035

374

giratubi modello svedese
ganasce sottili a 45°



DIN 5234

L	Ø	Ø	€		
mm	max "	max mm			
240	1/2" gas	21	38,50	1	003740024
320	1" gas	34	52,00	1	003740032
410	1"1/2 gas	49	68,00	1	003740041
550	2" gas	60	106,00	1	003740055
630	3" gas	90	189,50	1	003740063

375

giratubi modello svedese
ganasce parallele a 45°



DIN 5234

L	Ø	Ø	€		
mm	max "	max mm			
320	1" gas	34	52,00	1	003750032
410	1"1/2 gas	49	68,00	1	003750041
550	2" gas	60	106,00	1	003750055

376

giratubi modello svedese
ganasce piane a 90°



DIN 5234

L	Ø	Ø	€		
mm	max "	max mm			
320	1" gas	34	52,00	1	003760032
410	1"1/2 gas	49	68,00	1	003760041
550	2" gas	60	106,00	1	003760055
630	3" gas	90	192,50	1	003760063

378

giratubi modello svedese
ganasse sottili a 45°

DIN 5234

L mm	Ø max" gas	Ø max mm	€	🔧	📦
250	1/2"	21	41,00	1	003780025
320	1"	34	54,50	1	003780032
410	1 1/2"	49	70,50	1	003780041
550	2"	60	116,50	1	003780055
650	3"	90	196,00	1	003780065

374R/...

KIT ricambi completi per 374 - 375 - 376 - 378
composto da ghiera e fermaghiera

	€	🔧	📦
374R 240 374/240-378/250	2,30	1	003740724
374R 320 374/320-375/320-376/320-378/320	2,55	1	003740732
374R 410 374/410-375/410-376/410-378/410	3,15	1	003740741
374R 550 374/550-375/550-376/550-378/550	3,75	1	003740755
374R 630 374/630-378/650	5,70	1	003740763

383

giratubi reversibili a nastro



	Ø max" gas	Ø max mm	L mm	€	🔧	📦
383/1	3"	90	300	55,50	1	003830001
383/2	8"	220	300	58,50	1	003830002

383R

nastri di ricambio per 383

	S mm	€	🔧	📦
383R/1	27	22,60	1	003830010
383R/2	27	23,80	1	003830015

384

giratubi reversibile a catena



	Ø max" gas	Ø max mm	L mm	€	🔧	📦
	4"	115	300	75,00	1	003840032

384RC

catena di ricambio per 384



	€	🔧	📦
384RC	46,50	1	003840033

386A

giratubi reversibili a catena
modello pesante

	Ø max gas	L mm	€	🔧	📦
386A/1	4" gas 115 mm	900	255,00	1	003860001
386A/2	6" gas 168 mm	900	472,00	1	003860002
386A/5	8" gas 220 mm	1100	608,00	1	003860005
386A/6	12" gas 324 mm	1300	1.054,00	1	003860006

386A/RC

catene di ricambio per 386A



	€	🔧	📦
386A1/RC	79,50	1	003860011
386A2/RC	113,00	1	003860012
386A5/RC	150,00	1	003860015
386A6/RC	264,00	1	003860016



387

pinza curvatubi per tubi in rame e metalli non
ferrosi con matrici intercambiabili
3/16"-1/4"-5/16"-3/8"

L mm	Ø mm	€	🔧	📦
255	3/16"-1/4"-5/16"-3/8"	50,50	1	003870001

387R

matrici di ricambio per 387



	€	🔧	📦
3/16"-1/4"	12,80	1	003870010
5/16"-3/8"	13,50	1	003870015

388

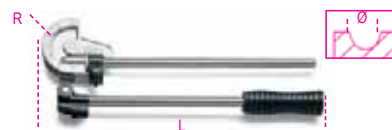
attrezzi curvatubi
per rame, lega leggera

Ø mm	L mm	R mm	€	🔧	📦
6	305	18,0	63,50	1	003880006
8	315	23,5	68,50	1	003880008
10	350	31,0	79,00	1	003880010
12	360	31,0	84,00	1	003880012
14	455	46,5	109,00	1	003880014
15	465	46,5	116,00	1	003880015
16	465	46,5	124,50	1	003880016

388A

pinza curvatubi
per rame e lega leggera

	Ø mm	L mm	€	🔧	📦
388A/1	6-8-10 mm	220	69,00	1	003880051
388A/2	1/4"-5/16"-3/8"	220	69,00	1	003880055

388C/C8

attrezzo curvatubi con 7 matrici per rame e lega leggera



	∅ mm	€		
388C/C8	10-12-14-16 18-20-22	503,00	1	003880200
400x330x110 mm - 3,6 kg				

389/K4

kit molle curvatubi per tubi in rame per uso esterno

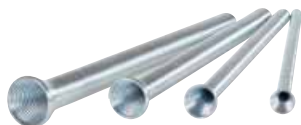

	∅ mm	L mm	€		
389/K4	1/4-3/8-1/2-5/8	290	21,30	1	003890001

392C

pinza regolabile per sifoni



	∅ mm	L mm	€		
392C	25+65	260	47,50	1	003920100

392RG/C

coppia di copriganasce di ricambio per 392C



	€		
392RG/C	6,50	1	003920101

Beta

393

pinza per dadi rubinetto



	L mm	€		
393	270	69,00	1	003930001

395

chiave per dadi rubinetto articolata



	∅ mm	L mm	€		
395	15+32 5/8"±1"1/4	240	45,50	1	003950001

395T

chiave per dadi rubinetto articolata, telescopica



	∅ mm	L mm	€		
395T	10+32 3/8"±1"1/4	250÷430	61,00	1	003950100

398

morse a catena da banco



	∅ mm	L mm	€		
398	1/2-8"	250	314,00	1	003980008

399

morse ribaltabili da banco

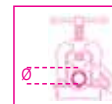

	∅ mm	L min mm	€		
399	10+60 1/8-2"	220	193,00	1	003990005
399	10+89 1/8-3"	290	346,00	1	003990010

399R/...

kit ricambio per 399 composto da due ganasce inferiori e una superiore



	€		
399R 1/8-2"	24,90	1	003990105
399R 1/8-3"	40,00	1	003990110

Beta

Beta

TABELLA PUNTE PER METALLO

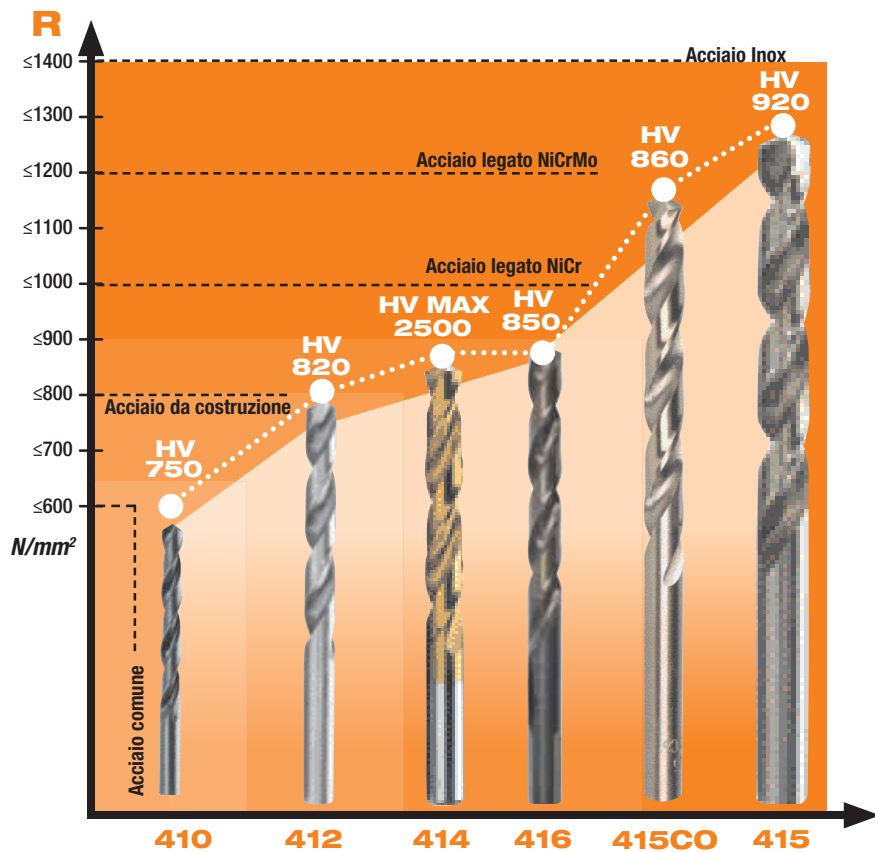

R N/mm² - resistenza meccanica del materiale da forare.

HV - durezza della punta secondo la scala Vickers: maggiore il valore, maggiore la durezza.

GUIDA ALLE PUNTE CILINDRICHE

Punte rullate - punte ottenute con un processo produttivo per laminazione a caldo. Buona qualità per impieghi non impegnativi quali la foratura di ferro, acciai dolci, leghe leggere e metalli non ferrosi in genere

Punte rettificate - punte ottenute interamente per rettifica da una barretta di acciaio trattato termicamente. Elevate prestazioni per la foratura di acciai e leghe leggere: rendimento costante, ottima evacuazione del truciolo e precisione dei fori.

HSS - acciaio super-rapido (high speed steel), ha elevata durezza e buona resistenza alle alte temperature; è il materiale migliore per la realizzazione di utensili da taglio e di utensili per la maschiatura e la filettatura.

Cobalto (Co) - componente di lega che aumenta la resistenza al calore dell'acciaio, diminuendo l'usura della punta anche a temperature elevate. Maggiore è la percentuale di cobalto, migliori saranno le prestazioni dell'utensile. Normalmente si utilizzano leghe con valori di cobalto al 5% e all'8%.

HSS-Co - acciaio super-rapido con presenza di cobalto in tenore del 5% o dell'8%.

TiN - sottilissimo rivestimento di nitruro di titanio grazie all'elevata durezza e al basso coefficiente di attrito aumenta la resistenza a fenomeni di usura e ossidazione. Migliora inoltre lo scorrimento dei trucioli di lavorazione.

Acciaio al cromo - gli utensili realizzati in acciaio al cromo sono indicati per l'utilizzo manuale nella filettatura su ferro, leghe leggere, acciai non trattati o trattati termicamente a bassa durezza. Trovano un'ampia applicazione nella pulizia e nel ripristino delle filettature danneggiate in tutti i lavori professionali e in particolare nel campo automotive.

Metallo duro - materiale con elevata resistenza all'usura, utilizzato nelle placchette delle punte per muratura.

Affilatura 118° - angolo di affilatura standard delle punte per metallo. Consente una rapida penetrazione nei metalli agevolando la centratura e ha un'ottima dissipazione del calore.

Affilatura 130° - angolo di affilatura ampio, offre una maggior precisione nelle fasi iniziali della foratura e richiede una minor forza di penetrazione.

Doppia affilatura 115°/135° - abbina i vantaggi di entrambi gli angoli, aggiungendo una funzione romptruciolo; per questo motivo è la scelta migliore per materiali con truciolo lungo.

SDS-Plus - codolo rapido e sicuro per martelli tassellatori.

410

punte elicoidali cilindriche
serie corta, in acciaio HSS
rullate

R ≤ 650 N/mm²
HV ~ 750÷820



DIN 338 ISO 235

Ø mm	L mm	L1 mm	€	🔧	📦
0,50	22	6	1,66	10	004100030
1,00	34	12	0,92	10	004100040
1,25	38	16	0,76	10	004100043
1,50	40	18	0,71	10	004100046
1,75	46	22	0,71	10	004100049
2,00	49	24	0,65	10	004100052
2,25	53	27	0,76	10	004100055
2,50	57	30	0,71	10	004100058
2,75	61	33	0,76	10	004100061
3,00	61	33	0,71	10	004100064
3,20	65	36	0,96	10	004100066
3,25	65	36	0,96	10	004100067
3,50	70	39	0,90	10	004100070
3,75	70	39	1,08	10	004100073
4,00	75	43	0,99	10	004100076
4,20	75	43	1,24	10	004100078
4,25	75	43	1,24	10	004100079
4,50	80	47	1,11	10	004100082
4,75	80	47	1,28	10	004100085
5,00	86	52	1,22	10	004100088
5,25	86	52	1,74	10	004100091
5,50	93	57	1,63	10	004100094
5,75	93	57	1,78	10	004100097
6,00	93	57	1,63	10	004100100
6,25	101	63	2,12	10	004100103
6,50	101	63	2,00	10	004100106
6,75	109	69	2,55	10	004100109
7,00	109	69	2,36	10	004100112
7,50	109	69	2,48	10	004100118
8,00	117	75	2,94	10	004100124
8,50	117	75	3,10	10	004100130
9,00	125	81	3,75	5	004100136
9,50	125	81	4,15	5	004100142
10,00	133	87	4,55	5	004100148
10,50	133	87	5,45	5	004100172
11,00	142	94	6,45	5	004100184
11,50	142	94	6,70	5	004100196
12,00	151	101	7,40	5	004100210
12,50	151	101	8,15	5	004100222
13,00	151	101	8,60	5	004100234
14,00	160	108	11,40	5	004100242
15,00	169	114	13,30	5	004100250
16,00	178	120	16,60	5	004100258
17,00	184	125	18,30	3	004100262
18,00	191	130	21,70	3	004100266
19,00	198	135	24,60	3	004100270
20,00	205	140	29,50	3	004100274



	€	🔧	📦
410/SP19 Ø 1÷10 x 0,5 mm	47,50	1	004100419
410/SPVP1	26,50	1	004100421
410/SP25 Ø 1÷13 x 0,5 mm	100,00	1	004100425
410/SPVP2	36,50	1	004100427



410/SEL19 € 37,00 1 004100418
 Ø 1=10 x 0,5 mm

410MIX/SEL19

serie di 13 punte 410
 e 6 punte con inserto in metallo duro



410MIX/SEL19 € 37,00 1 004100417



Ø 1 - 1,5 - 2 - 2,5 - 3 - 3,5 - 4
 4,5 - 5 - 5,5 - 6 - 8 - 10 mm

Ø 4 - 5 - 6 - 8 - 9 - 10 mm

410A

punte elicoidali cilindriche
 serie corta, in acciaio HSS rullate
 con codolo ridotto

R ≤ 650 N/mm²
 HV ~ 750±820



DIN 338 ISO 235

Ø mm	L mm	L1 mm	€		
13,50	160	108	13,40	5	004100281
14,00	160	108	13,40	5	004100283
14,50	169	114	15,60	5	004100285
15,00	169	114	15,60	5	004100287
15,50	178	120	19,30	5	004100289
16,00	178	120	19,30	5	004100291
16,50	184	125	20,30	3	004100292
17,00	184	125	20,30	3	004100293
17,50	191	130	24,10	3	004100294
18,00	191	130	24,10	3	004100295
18,50	198	135	27,00	3	004100296
19,00	198	135	27,00	3	004100297
19,50	205	140	31,50	3	004100298
20,00	205	140	31,50	3	004100299

410AS

punte elicoidali cilindriche
 serie corta, in acciaio HSS
 rullate,

in pollici

R ≤ 650 N/mm²
 HV ~ 750±820



ANSI B94

Ø "	L mm	L1 mm	€		
1/16	48	22	0,65	10	004100371
5/64	51	25	0,71	10	004100372
3/32	57	32	0,80	10	004100373
7/64	67	38	0,90	10	004100374
1/8	70	41	0,98	10	004100375
9/64	73	44	1,06	10	004100376
5/32	79	51	1,13	10	004100377
11/64	83	54	1,28	10	004100378
3/16	89	59	1,47	10	004100379
13/64	92	62	1,53	10	004100380
7/32	95	64	1,66	10	004100381
15/64	98	67	1,95	10	004100382
1/4	102	70	2,19	10	004100383
17/64	105	73	2,57	10	004100384
9/32	108	75	2,84	10	004100385
19/64	111	78	3,15	10	004100386
5/16	114	81	4,00	10	004100387
21/64	117	84	4,15	10	004100388
11/32	121	87	4,80	5	004100389
23/64	124	89	4,90	5	004100390
3/8	127	92	5,15	5	004100391



410AS/SP21 € 71,50 1 004100429

Ø 1/16-5/64-3/32-7/64
 1/8-9/64-5/32-11/64-3/16
 13/64-7/32-15/64-1/4
 17/64-9/32-19/64-5/16
 21/64-11/32-23/64-3/8

410AS/SPV1 € 27,00 1 004100430



410AS/SEL21 € 57,00 1 004100433

Ø 1/16-5/64-3/32-7/64
 1/8-9/64-5/32-11/64-3/16
 13/64-7/32-15/64-1/4
 17/64-9/32-19/64-5/16
 21/64-11/32-23/64-3/8

412

punte elicoidali cilindriche
 serie corta, in acciaio HSS
 rettificata lucide

R ≤ 800 N/mm²
 HV ~ 750±820



DIN 338 ISO 235

Ø mm	L mm	L1 mm	€		
0,50	22	6	2,88	10	004120030
1,00	34	12	1,85	10	004120040
1,25	38	16	1,98	10	004120043
1,50	40	18	1,66	10	004120046
1,75	46	22	1,66	10	004120049
2,00	49	24	1,40	10	004120052
2,25	53	27	1,78	10	004120055
2,50	57	30	1,53	10	004120058
2,75	61	33	1,78	10	004120061
3,00	61	33	1,61	10	004120064
3,25	65	36	2,10	10	004120067
3,50	70	39	1,93	10	004120070
3,75	70	39	2,30	10	004120073
4,00	75	43	2,10	10	004120076
4,25	75	43	2,69	10	004120079
4,50	80	47	2,41	10	004120082
4,75	80	47	2,88	10	004120085
5,00	86	52	2,69	10	004120088
5,25	86	52	3,80	10	004120091
5,50	93	57	3,50	10	004120094
5,75	93	57	4,25	10	004120097
6,00	93	57	3,65	10	004120100
6,25	101	63	5,30	10	004120103
6,50	101	63	4,65	10	004120106
6,75	109	69	5,95	10	004120109
7,00	109	69	5,45	10	004120112
7,25	109	69	6,65	5	004120115
7,50	109	69	5,65	5	004120118
7,75	117	75	7,60	5	004120121
8,00	117	75	6,95	5	004120124
8,25	117	75	8,45	5	004120127
8,50	117	75	8,55	5	004120130
8,75	125	81	9,40	5	004120133
9,00	125	81	8,90	5	004120136
9,25	125	81	10,30	5	004120139
9,50	125	81	9,30	5	004120142
9,75	133	87	11,50	5	004120145
10,00	133	87	10,30	5	004120148
10,25	133	87	15,70	5	004120149
10,50	133	87	13,80	5	004120150
10,75	142	94	18,80	5	004120151
11,00	142	94	16,50	5	004120152
11,25	142	94	20,00	5	004120153
11,50	142	94	17,40	5	004120154
11,75	142	94	21,70	5	004120155
12,00	151	101	19,10	5	004120156
12,25	151	101	23,60	5	004120157
12,50	151	101	20,40	5	004120158
12,75	151	101	27,00	5	004120159
13,00	151	101	21,60	5	004120160



412/SP19 € 94,50 1 004120419

Ø 1÷10 x 0,5 mm

410/SPVP1 € 26,50 1 004100421

412/SP25 € 196,00 1 004120425

Ø 1÷13 x 0,5 mm

410/SPVP2 € 36,50 1 004100427

412/SP49 € 470,00 1 004120449

Ø 1÷13 x 0,25 mm

412/SPV4 € 111,50 1 004120451



412/C150



412/C150 € 572,00 1 004120450

412 Ø 3 mm n. 20
 Ø 1 - 1,5 - 2 - 2,5 - 3 - 3,5 - 4 - 4,5 - 5 mm 10
 Ø 5,5 - 6 - 6,5 - 7 - 7,5 - 8 - 8,5 - 9 - 9,5 - 10 mm 5

365x230x47 mm - 3,3 kg



412/SP91 € 610,00 1 004120452

Ø 1÷10 x 0,10 mm

412A

punte elicoidali cilindriche
 serie corta, in acciaio HSS
 rettificate brunite
 con codolo ridotto

R ≤ 800 N/mm²
 HV ~ 750÷820



DIN 338 ISO 235

Ø mm	L mm	L1 mm	€	1	004120202
13,50	160	108	35,00	3	004120202
14,00	160	108	36,00	3	004120204
14,50	169	114	38,50	3	004120206
15,00	169	114	40,50	3	004120208
15,50	178	120	46,50	3	004120210
16,00	178	120	48,00	3	004120212
16,50	184	125	49,50	1	004120213
17,00	184	125	53,00	1	004120214
17,50	191	130	56,50	1	004120215
18,00	191	130	60,00	1	004120216
18,50	198	135	64,50	1	004120217
19,00	198	135	66,50	1	004120218
19,50	205	140	74,50	1	004120219
20,00	205	140	76,00	1	004120220

412L

punte elicoidali cilindriche
 serie lunga, in acciaio HSS
 rettificate brunite

R ≤ 800 N/mm²
 HV ~ 750÷820



DIN 340

Ø mm	L mm	L1 mm	€	10	004120232
2,00	85	56	3,80	10	004120232
2,50	95	62	4,05	10	004120234
3,00	100	66	4,25	10	004120236
3,50	112	73	4,85	10	004120238
4,00	119	78	5,30	10	004120240
4,50	126	82	6,40	10	004120242
5,00	132	87	6,65	10	004120244
5,50	139	91	8,45	10	004120246
6,00	139	91	9,05	10	004120248
6,50	148	97	10,80	5	004120250
7,00	156	102	12,60	5	004120252
8,00	165	109	16,80	5	004120256
9,00	175	115	19,80	5	004120260
10,00	184	121	21,70	5	004120264

412XL

punte elicoidali cilindriche
 serie extra lunga, in acciaio HSS
 rettificate

R ≤ 800 N/mm²
 HV ~ 750÷820



DIN 1869/1

Ø mm	L mm	L1 mm	€	1	004120520
3,00	150	100	14,60	1	004120520
3,50	165	115	16,10	1	004120522
4,00	175	120	16,10	1	004120524
4,50	185	125	16,60	1	004120526
5,00	195	135	16,60	1	004120528
5,50	205	140	20,40	1	004120530
6,00	205	140	20,40	1	004120532
6,50	215	150	24,10	1	004120534
7,00	225	155	28,00	1	004120536
7,50	225	155	32,50	1	004120538
8,00	240	165	34,50	1	004120540
8,50	240	165	36,00	1	004120542
9,00	250	175	46,00	1	004120544
9,50	250	175	49,50	1	004120546
10,00	265	185	49,50	1	004120548
10,50	265	185	49,50	1	004120550
11,00	280	195	49,50	1	004120552
12,00	295	205	63,00	1	004120556
13,00	295	205	65,50	1	004120560

414

punte elicoidali cilindriche
 serie corta, in acciaio HSS-TiN
 rettificate

R ≤ 900 N/mm²
 HV 0,05 ~ 2500



DIN 338 ISO 235

Ø mm	L mm	L1 mm	€	10	004140040
1,00	34	12	2,51	10	004140040
1,25	38	16	2,88	10	004140042
1,50	40	18	2,24	10	004140046
1,75	46	22	2,88	10	004140048
2,00	49	24	2,36	10	004140052
2,25	53	27	2,94	10	004140054
2,50	57	30	2,48	10	004140058
2,75	61	33	3,40	10	004140060
3,00	61	33	2,79	10	004140064
3,25	65	36	3,60	10	004140066
3,50	70	39	3,40	10	004140070
3,75	70	39	3,75	10	004140072
4,00	75	43	3,40	10	004140076
4,25	75	43	4,15	10	004140078
4,50	80	47	3,75	10	004140082
4,75	80	47	4,70	10	004140084
5,00	86	52	4,40	10	004140088
5,25	86	52	6,10	10	004140090
5,50	93	57	5,25	10	004140094
5,75	93	57	6,40	10	004140096
6,00	93	57	5,85	10	004140100
6,25	101	63	7,40	10	004140102
6,50	101	63	6,50	10	004140106
6,75	109	69	8,90	10	004140108
7,00	109	69	7,15	10	004140112
7,25	109	69	9,85	5	004140114
7,50	109	69	8,80	5	004140118
7,75	117	75	11,50	5	004140120
8,00	117	75	10,30	5	004140124
8,25	117	75	12,00	5	004140125
8,50	117	75	10,70	5	004140130
8,75	125	81	14,90	5	004140132
9,00	125	81	13,30	5	004140136
9,25	125	81	17,00	5	004140138
9,50	125	81	14,90	5	004140142
9,75	133	87	17,80	5	004140144
10,00	133	87	15,80	5	004140148
10,50	133	87	18,50	5	004140150
11,00	142	94	20,00	5	004140152
11,50	142	94	21,70	5	004140154
12,00	151	101	23,20	5	004140156
12,50	151	101	27,00	5	004140158
13,00	151	101	28,00	5	004140160



414/SP19	€ 138,50	1	004140419
Ø 1÷10 x 0,5 mm			
410/SPVP1	26,50	1	004100421
414/SP25	280,00	1	004140425
Ø 1÷13 x 0,5 mm			
410/SPVP2	36,50	1	004100427
414/SP49	616,00	1	004140429
Ø 1÷13 x 0,25 mm			
414/SPV4	111,50	1	004140430

414/C116



414/C116 € 564,00 1 004140450

414 n.
 Ø 1 - 1,5 - 2 - 2,5 - 3 - 3,5 - 4 - 4,5 - 5 mm 10
 Ø 5,5 - 6 - 6,5 - 7 - 7,5 - 8 mm 3
 Ø 8,5 - 9 - 9,5 - 10 mm 2

365x230x47 mm - 2,7 Kg

415

punte elicoidali cilindriche
 serie corta, in acciaio HSS-CO 8%
 rettificata

R ≤ 1400 N/mm²
 HV ~ 850+920



DIN 338 ISO 235

Ø mm	L mm	L1 mm	€		
0,50	22	6	7,05	10	004150029
1,00	34	12	3,50	10	004150040
1,25	38	16	3,85	10	004150043
1,50	40	18	3,50	10	004150046
1,75	46	22	3,65	10	004150049
2,00	49	24	3,40	10	004150052
2,25	53	27	4,15	10	004150055
2,50	57	30	3,75	10	004150058
2,75	61	33	4,15	10	004150061
3,00	61	33	3,80	10	004150064
3,25	65	36	5,25	10	004150067
3,50	70	39	4,80	10	004150070
3,75	70	39	5,85	10	004150073
4,00	75	43	5,25	10	004150076
4,25	75	43	6,55	10	004150079
4,50	80	47	5,95	10	004150082
4,75	80	47	6,85	10	004150085
5,00	86	52	6,40	10	004150088
5,25	86	52	9,30	10	004150091
5,50	93	57	8,45	10	004150094
5,75	93	57	9,75	10	004150097
6,00	93	57	8,90	10	004150100
6,25	101	63	12,60	10	004150103
6,50	101	63	11,00	10	004150106
6,75	109	69	14,50	10	004150109
7,00	109	69	13,00	10	004150112
7,25	109	69	15,70	5	004150115
7,50	109	69	14,10	5	004150118
7,75	117	75	18,40	5	004150121
8,00	117	75	16,60	5	004150124
8,25	117	75	20,00	5	004150127
8,50	117	75	18,80	5	004150130
8,75	125	81	24,80	5	004150133
9,00	125	81	21,90	5	004150136
9,25	125	81	26,00	5	004150139
9,50	125	81	23,70	5	004150142
9,75	133	87	28,00	5	004150145
10,00	133	87	26,00	5	004150148
10,25	133	87	33,50	5	004150149
10,50	133	87	28,50	5	004150150
10,75	142	94	37,00	5	004150151
11,00	142	94	33,50	5	004150152
11,25	142	94	41,50	5	004150153
11,50	142	94	36,50	5	004150154
11,75	142	94	42,50	5	004150155

Ø mm	L mm	L1 mm	€		
12,00	151	101	39,50	5	004150156
12,25	151	101	50,50	5	004150157
12,50	151	101	42,50	5	004150158
12,75	151	101	55,50	5	004150159
13,00	151	101	45,50	5	004150160
14,00	160	108	80,00	3	004150164
15,00	169	114	94,50	3	004150168
16,00	178	120	116,00	3	004150172
17,00	186	125	132,00	1	004150174
18,00	194	130	146,50	1	004150176
19,00	202	135	168,50	1	004150178
20,00	210	140	189,50	1	004150180



415/SP19	€		
Ø 1÷10 x 0,5 mm	194,50	1	004150419
410/SPVP1	26,50	1	004100421
415/SP25	403,00	1	004150425
Ø 1÷13 x 0,5 mm			
410/SPVP2	36,50	1	004100427
415/SP49	1.001,00	1	004150431
Ø 1÷13 x 0,25 mm			
415/SPV4	111,50	1	004150432

415/C116



415/C116 € 850,00 1 004150450

415 n.
 Ø 1 - 1,5 - 2 - 2,5 - 3 - 3,5 - 4 - 4,5 - 5 mm 10
 Ø 5,5 - 6 - 6,5 - 7 - 7,5 - 8 mm 3
 Ø 8,5 - 9 - 9,5 - 10 mm 2

365x230x47 mm - 2,7 kg



415/SP91 € 1.167,00 1 004150460
 Ø 1÷10 x 0,10 mm

415CO

punte elicoidali cilindriche
 serie corta, in acciaio HSS-CO 5%
 rettificata

R ≤ 1200 N/mm²
 HV ~ 800+860



DIN 338 ISO 235

Ø mm	L mm	L1 mm	€		
1,00	34	12	1,78	10	004150310
1,50	40	18	1,78	10	004150312
2,00	49	24	1,78	10	004150314
2,50	57	30	1,85	10	004150316
3,00	61	33	1,85	10	004150320
3,50	70	39	2,30	10	004150322
4,00	75	43	2,69	10	004150324
4,50	80	47	3,10	10	004150326
5,00	86	52	3,20	10	004150328
5,50	93	57	4,05	10	004150330
6,00	93	57	4,50	10	004150332
6,50	101	63	5,35	10	004150334
7,00	109	69	6,60	10	004150336
7,50	109	69	7,20	5	004150338
8,00	117	75	8,55	5	004150340
8,50	117	75	8,90	5	004150342
9,00	125	81	10,90	5	004150344
9,50	125	81	11,50	5	004150346
10,00	133	87	13,30	5	004150348
10,50	133	87	16,10	5	004150350
11,00	142	94	17,80	5	004150352
11,50	142	94	19,60	5	004150354
12,00	151	101	21,40	5	004150356
12,50	151	101	23,30	5	004150358
13,00	151	101	25,50	5	004150360

415CO-A

punte elicoidali cilindriche
 serie corta, in acciaio HSS-CO 5%
 rettificata

con codolo ridotto

R ≤ 1200 N/mm²
 HV ~ 800+860



DIN 338

Ø mm	L mm	L1 mm	€		
14,00	160	108	49,50	3	004150364
15,00	169	114	57,00	3	004150366
16,00	178	120	69,00	3	004150368
17,00	184	125	70,50	1	004150370
18,00	191	130	90,50	1	004150372
19,00	198	135	104,50	1	004150374
20,00	205	140	120,50	1	004150376



DIN 338

415CO/SP19 € 102,00 1 004150421
 Ø 1÷10 x 0,5 mm
 410/SPVP1 € 26,50 1 004100421

415L

punte elicoidali cilindriche
serie lunga, in acciaio HSS-CO 5%
rettificate

R ≤ 1200 N/mm²
HV ~ 800÷860



DIN 340

Ø mm	L mm	L1 mm	€	🔧	📦
3,00	100	66	4,85	10	004150236
3,50	112	73	5,35	10	004150238
4,00	119	78	6,60	10	004150240
4,50	126	82	8,10	10	004150242
5,00	132	87	8,45	10	004150244
5,50	139	91	10,50	10	004150246
6,00	139	91	11,50	10	004150248
6,50	148	97	13,50	5	004150250
7,00	156	102	16,10	5	004150252
8,00	165	109	20,40	5	004150256
9,00	175	115	25,50	5	004150260
10,00	184	121	33,00	5	004150264

416

punta cilindrica con affilatura speciale
a doppia coppia di taglienti, in acciaio HSS-G

R ≤ 900 N/mm²
HV ~ 820÷850



DIN 338

Ø mm	L mm	L1 mm	€	🔧	📦
1,00	34	12	2,74	10	004160010
1,50	40	18	2,74	10	004160015
2,00	49	24	2,74	10	004160020
2,50	57	30	2,88	10	004160025
3,00	61	33	3,10	10	004160030
3,50	70	39	3,45	10	004160035
4,00	75	43	3,80	10	004160040
4,50	80	47	4,25	10	004160045
5,00	86	52	4,80	10	004160050
5,50	93	57	6,20	10	004160055
6,00	93	57	6,60	10	004160060
6,50	101	63	7,85	10	004160065
7,00	109	69	9,05	10	004160070
7,50	109	69	9,75	5	004160075
8,00	117	75	11,60	5	004160080
8,50	117	75	12,60	5	004160085
9,00	125	81	14,70	5	004160090
9,50	125	81	15,80	5	004160095
10,00	133	87	18,20	5	004160100



416/SP19	137,50	1	004160419
Ø 1÷10 x 0,5 mm			
410/SPVP1	26,50	1	004100421

416P/SP19

serie di 19 punte elicoidali cilindriche in HSS,
AISI M2
con punta ridotta per centraggio

R ≤ 900 N/mm²
HV ~ 820÷850

VELOCITÀ
DI FORATURA
SUPERIORE



416P/SP19 149,50 1 004160469

Ø 1÷10 x 0,5 mm

115x170x40 mm

417

punte elicoidali cilindriche per muratura
serie corta, in acciaio fresato
con placchetta in metallo duro

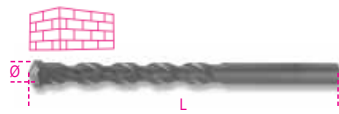

DIN 8039

Ø mm	L mm	€	🔧	📦
3	70	3,65	10	004170003
4	75	3,65	10	004170004
5	85	3,85	10	004170005
5L	150	8,70	5	004170105
6	100	4,00	10	004170007
6L	150	8,70	5	004170106
7	120	4,50	10	004170009
8	120	4,95	10	004170010
8L	200	9,40	5	004170113
9	120	5,60	10	004170011
10	120	6,55	10	004170012
10L	200	11,30	5	004170120
12	150	8,55	10	004170014
12L	200	12,30	5	004170125
14	150	11,90	5	004170016
16	150	14,70	5	004170018



417/SP8	55,50	1	004170100
Ø 3-4-5-6-8-9-10-12 mm			

419

punte per muratura
corpo fresato con placchetta
in metallo duro
HVA~ 1650

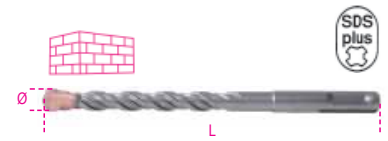

Ø mm	L mm	€	🔧	📦
4	110	7,50	10	004190002
5	110	7,50	10	004190004
5	160	8,30	10	004190006
6	110	7,35	10	004190012
6	160	8,10	10	004190014
6	210	10,80	10	004190016
7	160	8,90	10	004190028
8	110	7,95	10	004190030
8	160	8,55	10	004190032
8	210	10,30	10	004190034
8	260	14,00	10	004190036
8	310	17,20	10	004190038
8	460	31,50	10	004190042
9	160	10,50	5	004190044
10	160	10,80	5	004190050
10	210	12,50	5	004190052
10	260	15,60	5	004190054
10	310	21,90	5	004190056
10	460	34,50	5	004190060
12	160	12,00	5	004190064
12	210	16,30	5	004190066
12	260	17,50	5	004190068
12	460	36,00	5	004190074
14	160	16,60	3	004190086
14	260	20,00	3	004190090
14	310	28,50	3	004190092
14	460	37,00	3	004190096
16	210	24,50	3	004190112
16	260	26,00	3	004190114
16	310	31,50	3	004190116
16	460	41,50	3	004190120
18	260	33,50	1	004190124
20	310	33,50	1	004190128



419/SP7	77,00	1	004190507
Ø 5 - 6 - 8 x 110 mm			
Ø 6 - 8 - 10 - 12 x 160 mm			



419T

punte per muratura
corpo fresato con
4 eliche e 4 taglienti

HVA~ 1650



Ø mm	L mm	€		
5	110	5,10	5	004190604
5	160	5,70	5	004190606
6	110	5,35	5	004190612
6	160	6,30	5	004190614
6	210	8,55	5	004190616
7	160	6,40	5	004190628
8	110	5,85	5	004190630
8	160	6,60	5	004190632
8	210	8,80	5	004190634
8	260	10,00	5	004190636
8	310	12,30	5	004190638
9	160	7,00	3	004190644
10	160	7,05	3	004190650
10	210	9,40	3	004190652
10	260	10,20	3	004190654
10	310	14,60	3	004190656
10	460	19,80	3	004190660
12	160	7,90	3	004190664
12	210	10,30	3	004190666
12	260	10,90	3	004190668
12	460	20,40	3	004190674
14	160	10,70	2	004190686
14	260	12,50	2	004190690
14	310	17,70	2	004190692
14	460	19,80	2	004190696
16	210	14,20	2	004190712
16	260	18,80	2	004190714
16	310	20,30	2	004190716
16	460	21,00	2	004190720
18	260	23,00	1	004190724
20	310	28,00	1	004190728

421

svasatori con perno guida
grado fine
in acciaio HSS



DIN 373

M	L mm	Ø mm	D1 mm	D mm	€		
3	71	6	3,2	5	27,50	1	004210003
4	71	8	4,3	5	27,50	1	004210004
5	80	10	5,3	8	27,50	1	004210005
6	80	11	6,4	8	28,00	1	004210006
8	100	15	8,4	12,5	45,50	1	004210008
10	100	18	10,5	12,5	54,00	1	004210010
12	100	20	13,0	12,5	58,50	1	004210012



421/SP6	€ 223,00	1	004210019
M 3-4-5-6-8-10			
421/SPV	€ 16,60	1	004210020

422

punte a centrare rettificate
angolo di svasatura 60°
in acciaio HSS

• Per l'esecuzione rapida e sicura dei fori di centraggio



DIN 333/A

Ø mm	D mm	L mm	€		
1,60	4,0	35,5	8,70	1	004220116
2,50	6,3	45,0	9,95	1	004220125
3,15	8,0	50,0	11,20	1	004220131

423

punte speciali
per punti di saldatura
in acciaio HSS, rettificate



Ø mm	L mm	€		
6	66	17,20	5	004230006
7	74	21,00	5	004230007
8	79	23,00	5	004230008
10	89	27,00	5	004230010

423A

fresse speciali per punti
di saldatura, in acciaio HSS
rettificate



DIN 1412/E

Ø mm	L mm	€		
6,5	40	25,50	1	004230015
8,0	40	27,50	1	004230020

424

fresse coniche per forare
ed allargare
in acciaio HSS



	L mm	Ø mm	D mm	€		
424/1	58	3÷14	6	32,00	2	004240001
424/2	63	6÷20	8	53,50	2	004240002
424/3	60	16÷30	10	91,50	2	004240003
424/4	80	3÷22	8	112,00	1	004240004
424/5	102	3÷31	10	151,00	1	004240005
424/6	86	26÷40	13	192,00	1	004240006
424/7	89	36÷50	13	288,00	1	004240007
424/8	90	40÷61	13	477,00	1	004240008



424/SP3	€ 183,50	1	004240019
424/1+424/2+424/3			
Ø 3÷30 mm			
424/SPV	€ 25,50	1	004240020

425

fresse coniche a gradino
in acciaio HSS



	L mm	Ø mm	S mm	D mm	€		
425/1	70	4÷12	1	6	54,00	2	004250010
425/2	55	4÷12	2	6	57,00	2	004250012
425/3	85	4÷20	2	10	83,00	2	004250015
425/4	85	12÷20	1	10	126,50	1	004250016
425/5	97	20÷30	1	10	248,50	1	004250017
425/6	75	4÷30	2	10	173,00	1	004250020
425/7	97	30÷40	1	13	345,00	1	004250025
425/8	100	40÷50	1	13	481,00	1	004250029



425/SP3	€ 316,00	1	004250030
425/1+425/3+425/6			
Ø 4÷30 mm			
425/SPV	€ 25,50	1	004250035

426

frese a svasare ed incassare
a tre taglienti
in acciaio HSS



DIN 335-C

GR	Ø mm	L mm	Ø1 mm	€	Icon	Icon
1	4,3	44	4	18,00	3	004260001
2	5,3	44	4	18,00	3	004260002
3	6,3	44	5	18,80	3	004260003
4	7,3	44	6	22,00	3	004260004
5	8,3	50	6	22,00	3	004260005
6	9,4	50	6	24,50	3	004260006
7	10,4	54	6	27,50	3	004260007
8	12,4	54	8	29,50	3	004260008
9	15,0	56	10	33,50	3	004260009
10	16,5	60	10	35,50	3	004260010
11	20,5	63	10	48,50	3	004260011
12	25,0	66	10	77,00	3	004260012
13	28,0	71	12	103,50	3	004260013
14	31,0	71	12	109,50	3	004260014



DIN 335-C

426/SP6	192,50	1	004260030
GR 3-5-7-8-10-11			
Ø 6,3÷20,5 mm			
426/SPV	25,50	1	004260035

426A/SP6

serie di 6 frese a svasare ed incassare
a tre taglienti asimmetrici e a spirale
in acciaio HSS



426A/SP6	201,00	1	004260060
Ø 6,3-8,3-10,4-12,4-16,5-20,5 mm			

100x145x40 mm

426T

frese a svasare ed incassare
a tre taglienti
in acciaio HSS + TiN

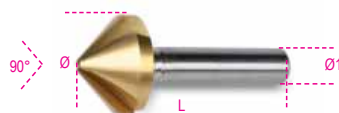

DIN 335-C

GR	Ø mm	L mm	Ø1 mm	€	Icon	Icon
1	4,3	44	4	23,40	3	004260061
2	5,3	44	4	23,40	3	004260062
3	6,3	44	5	24,00	3	004260063
4	7,3	44	6	27,00	3	004260064
5	8,3	50	6	27,00	3	004260065
6	9,4	50	6	28,50	3	004260066
7	10,4	54	6	33,50	3	004260067
8	12,4	54	8	35,00	3	004260068
9	15,0	56	10	39,00	3	004260069
10	16,5	60	10	44,00	3	004260070
11	20,5	63	10	57,00	3	004260071
12	25,0	66	10	86,50	3	004260072
13	28,0	71	12	108,00	3	004260073
14	31,0	71	12	116,00	3	004260074



DIN 335-C

426T/SP6	220,00	1	004260080
GR 3-5-7-8-10-11			
Ø 6,3÷20,5 mm			
426/SPV	25,50	1	004260035

426SB

frese a svasare e svasare
in acciaio HSS



GR	Ø mm	D mm	L mm	€	Icon	Icon
426/SB1	1 2÷5	6	45	24,30	1	004260101
426/SB2	2 5÷10	8	48	30,00	1	004260102
426/SB3	3 10÷15	10	65	54,00	1	004260103
426/SB4	4 15÷20	12	85	104,00	1	004260104
426/SB5	5 20÷25	15	102	175,00	1	004260105
426/SB6	6 25÷30	15	115	296,00	1	004260106



426SB/SP4	241,50	1	004260130
426/SB1-426/SB2			
426/SB3-426/SB4			
Ø 2÷20 mm			
426SB/SPV1	25,50	1	004260135

426MD-3/CP3

mini frese rotative in metallo duro

• Taglio incrociato tipo dolce con rompitruciolo



L mm	Ø mm	€	Icon	Icon
38,1	3	13,30	1	004260332

426MD-3/CT3

mini frese rotative in metallo duro

• Taglio incrociato tipo dolce con rompitruciolo



L mm	Ø mm	€	Icon	Icon
37,8	3	13,30	1	004260333

426MD-3/F3

mini frese rotative in metallo duro

• Taglio incrociato tipo dolce con rompitruciolo



L mm	Ø mm	€	Icon	Icon
38,3	3	13,30	1	004260334

426MD-3/FA3

mini frese rotative in metallo duro

• Taglio incrociato tipo dolce con rompitruciolo



L mm	Ø mm	€	Icon	Icon
38,2	3	13,30	1	004260339

426MD-3/OG3

mini frese rotative in metallo duro

• Taglio incrociato tipo dolce con rompitruciolo



L mm	Ø mm	€	Icon	Icon
38,1	3	13,30	1	004260337

426MD-3/OV3

mini frese rotative in metallo duro

• Taglio incrociato tipo dolce con rompitruciolo



L mm	Ø mm	€		
38,2	3	13,30	1	004260331

426MD-3/S3

mini frese rotative in metallo duro

• Taglio incrociato tipo dolce con rompitruciolo



L mm	Ø mm	€		
38,0	3	13,30	1	004260338

426MD-3/T3

mini frese rotative in metallo duro

• Taglio incrociato tipo dolce con rompitruciolo



L mm	Ø mm	€		
38,3	3	13,30	1	004260336

426MD-3/TA3

mini frese rotative in metallo duro

• Taglio incrociato tipo dolce con rompitruciolo



L mm	Ø mm	€		
38,3	3	13,30	1	004260335



426MD-3/A9

426MD-3/OV3 - 426MD-3/CP3
426MD-3/CT3 - 426MD-3/F3
426MD-3/TA3 - 426MD-3/T3
426MD-3/OG3 - 426MD-3/S3
426MD-3/FA3

€		
119,50	1	004260349

426MD/CP

lime rotative in metallo duro

taglio incrociato HM4



L mm	Ø mm	€		
50	6	37,00	1	004260532
63	8	41,00	1	004260512
63	9,5	46,00	1	004260542
69	12	65,00	1	004260522
69	16	93,00	1	004260552

426MD/CT

lime rotative in metallo duro

taglio incrociato HM4



L mm	Ø mm	€		
50	6	37,00	1	004260533
63	8	41,00	1	004260513
63	9,5	46,00	1	004260543
69	12	65,00	1	004260523
69	16	90,00	1	004260553

426MD/F

lime rotative in metallo duro

taglio incrociato HM4



L mm	Ø mm	€		
50	6	37,00	1	004260534
63	8	41,00	1	004260514
63	9,5	46,00	1	004260544
69	12	65,00	1	004260524
69	16	73,50	1	004260554

426MD/FA

lime rotative in metallo duro

taglio incrociato HM4



L mm	Ø mm	€		
50	6	37,00	1	004260539
63	8	41,00	1	004260519
63	9,5	46,00	1	004260549
69	12	65,00	1	004260529
69	16	83,50	1	004260559

426MD/OG

lime rotative in metallo duro

taglio incrociato HM4



L mm	Ø mm	€		
50	6	37,00	1	004260537
63	8	41,00	1	004260517
70	10	46,00	1	004260547
76	12	65,00	1	004260527
81	16	93,00	1	004260557

426MD/OV

lime rotative in metallo duro

taglio incrociato HM4



L mm	Ø mm	€		
50	6	37,00	1	004260531
61	9,5	46,00	1	004260541
67	12	65,00	1	004260521
69	16	83,50	1	004260551

426MD/S

lime rotative in metallo duro

taglio incrociato HM4



L mm	Ø mm	€		
50	6	37,00	1	004260538
51	8	41,00	1	004260518
53	9,5	46,00	1	004260548
56	12	65,00	1	004260528
59	16	73,50	1	004260558

426MD/T

lime rotative in metallo duro

taglio incrociato HM4



L mm	Ø mm	€		
50	6	37,00	1	004260536
63	8	41,00	1	004260516
63	9,5	46,00	1	004260546
69	12	65,00	1	004260526
70	16	73,50	1	004260556

426MD/TA

lime rotative in metallo duro

taglio incrociato HM4



L mm	Ø mm	€		
50	6	37,00	1	004260535
67	8	41,00	1	004260515
72	9,5	46,00	1	004260545
73	12	65,00	1	004260525
78	16	93,00	1	004260555



426MD/SP10

426MD/CP-426MD/CT-426MD/F
426MD/T-426MD/S
Ø 8-12 mm

€		
479,00	1	004260510

427

estrattori con Morse



DIN 317

GR	L mm	A mm	€		
0	92	13	12,90	3	004270000
1-2	140	19	18,20	3	004270002
3	190	25	21,90	3	004270003
4	225	30	37,00	3	004270004
5-6	260	35	67,50	3	004270006

428FP

maschi a macchina per fori passanti
passo grosso
in acciaio HSS



ISO 529

M	■ mm	L mm	L1 mm	€		
3x0,5	2,7	56	11	17,60	10	004280003
4x0,7	3,4	63	13	17,60	10	004280004
5x0,8	4,9	70	16	17,60	10	004280005
6x1	4,9	80	19	18,50	10	004280006
8x1,25	6,2	90	22	22,40	10	004280008
10x1,5	8,0	100	24	26,50	10	004280010
12x1,75	7,0	110	29	34,50	5	004280012
14x2	9,0	110	30	42,00	5	004280014
16x2	9,0	110	30	50,50	5	004280016
18x2,5	11,0	125	34	65,00	3	004280018
20x2,5	12,0	140	34	73,00	3	004280020
22x2,5	14,5	140	34	88,00	3	004280022
24x3	14,5	160	38	95,50	3	004280024

428FC

maschi a macchina per fori ciechi
passo grosso
in acciaio HSS



ISO 529

M	■ mm	L mm	L1 mm	€		
3x0,5	2,7	56	11	21,30	10	004280103
4x0,7	3,4	63	13	21,30	10	004280104
5x0,8	4,9	70	16	21,30	10	004280105
6x1	4,9	80	19	21,90	10	004280106
8x1,25	6,2	90	22	23,80	10	004280108
10x1,5	8,0	100	24	28,00	10	004280110
12x1,75	7,0	110	29	36,00	5	004280112
14x2	9,0	110	30	48,00	5	004280114
16x2	9,0	110	30	56,50	5	004280116
18x2,5	11,0	125	34	76,00	3	004280118
20x2,5	12,0	140	34	81,50	3	004280120
22x2,5	14,5	140	34	99,00	3	004280122
24x3	14,5	160	38	105,00	3	004280124

428/C14

assortimento di 14 maschi a macchina
428FP+428FC
in acciaio HSS



428/C14	€		
428FP M3÷12	383,00	1	004280201
428FC M3÷12			
428/SPV	22,40	1	004280202

429FP

maschi a macchina per fori passanti
passo grosso
in acciaio HSS-CO 5%



ISO 529

M	■ mm	L mm	L1 mm	€		
3x0,5	2,7	56	11	23,00	5	004290003
4x0,7	3,4	63	13	23,00	5	004290004
5x0,8	4,9	70	16	23,00	5	004290005
6x1	4,9	80	19	24,90	5	004290006
8x1,25	6,2	90	22	27,50	5	004290008
10x1,5	8,0	100	24	32,50	5	004290010
12x1,75	7,0	110	29	40,50	5	004290012
14x2	9,0	110	30	54,00	5	004290014

429FC

maschi a macchina per fori ciechi
passo grosso
in acciaio HSS-CO 5%



ISO 529

M	■ mm	L mm	L1 mm	€		
3x0,5	2,7	56	11	28,00	5	004290103
4x0,7	3,4	63	13	28,00	5	004290104
5x0,8	4,9	70	16	28,00	5	004290105
6x1	4,9	80	19	29,50	5	004290106
8x1,25	6,2	90	22	33,00	5	004290108
10x1,5	8,0	100	24	39,50	5	004290110
12x1,75	7,0	110	29	48,00	5	004290112
14x2	9,0	110	30	63,00	5	004290114

429/C14

assortimento di 14 maschi a macchina
429FP+429FC
in acciaio HSS-CO 5%



429/C14	€		
429FP M3÷12	470,00	1	004290201
429FC M3÷12			
428/SPV	22,40	1	004280202

430

serie di 3 maschi a mano
sgrossatore, intermedio, finitore
passo grosso, in acciaio al cromo

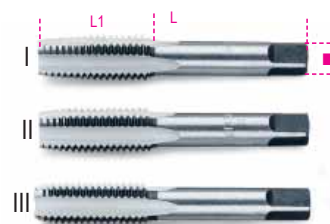

DIN 352 UNI 4535

M	■ mm	L mm	L1 mm	€		
2x0,4	2,5	36	11	15,30	5	004300002
3x0,5	2,5	40	12	10,80	5	004300003
4x0,7	3,0	45	14	10,80	5	004300004
5x0,8	4,0	48	16	11,20	5	004300005
6x1	5,0	50	18	11,30	5	004300006
7x1	4,5	50	18	14,50	5	004300007
8x1,25	5,0	56	22	14,60	3	004300008
9x1,25	5,5	63	22	19,80	3	004300009
10x1,5	6,0	70	25	18,80	3	004300010
11x1,5	7,0	70	25	24,10	3	004300011
12x1,75	7,0	75	30	24,10	3	004300012
14x2	8,0	80	32	30,50	3	004300014
16x2	10,0	80	32	36,00	3	004300016
18x2,5	11,0	95	40	48,00	1	004300018
20x2,5	12,0	95	40	57,50	1	004300020
22x2,5	14,5	100	40	70,00	1	004300022
24x3	14,5	110	50	83,00	1	004300024



430/SP21	€		
M 3-4-5-6-8-10-12	129,50	1	004300201
430/SPV	27,00	1	004300202

430ASW

serie di 3 maschi a mano
sgrossatore, intermedio, finitore
Whitworth, in acciaio al cromo



DIN 352

BSW	mm	L	L1	€	Icon	Icon
1/8x40	2,7	40	12	10,60	5	004300031
5/32x32	3,4	45	14	10,60	5	004300032
3/16x24	4,3	48	18	10,60	5	004300033
1/4x20	4,9	50	22	12,40	5	004300034
5/16x18	4,9	56	25	15,00	3	004300035
3/8x16	5,5	70	28	19,80	3	004300036
7/16x14	6,2	70	30	22,40	3	004300037
1/2x12	7,0	75	32	25,00	3	004300038
9/16x12	9,0	80	32	30,50	1	004300039
5/8x11	9,0	80	38	36,50	1	004300040
3/4x10	11,0	95	40	53,00	1	004300041
7/8x9	14,5	100	40	66,50	1	004300042
1"x8	16,0	110	50	86,00	1	004300043

430ASC

serie di 3 maschi a mano
sgrossatore, intermedio, finitore
UNC, in acciaio al cromo



ANSI B1.1

UNC	mm	L	L1	€	Icon	Icon
1/4x20	4,9	70	30	15,80	5	004300051
5/16x18	4,9	70	30	20,40	5	004300052
3/8x16	5,5	75	35	23,00	3	004300053
7/16x14	6,2	80	40	30,00	3	004300054
1/2x13	7,0	85	45	37,50	3	004300055
9/16x12	9,0	90	45	46,00	3	004300056
5/8x11	9,0	100	47	53,00	3	004300057
3/4x10	11,0	110	50	71,50	3	004300058
7/8x9	14,5	120	60	82,50	1	004300059
1"x8	16,0	130	60	93,00	1	004300060

431

serie di 3 maschi a mano
sgrossatore, intermedio, finitore
passo grosso, in acciaio HSS



DIN 352 UNI 4535

M	mm	L	L1	€	Icon	Icon
3x0,5	2,5	40	12	20,40	5	004310003
4x0,7	3,0	45	14	20,40	5	004310004
5x0,8	4,0	48	16	21,00	5	004310005
6x1	5,0	50	18	21,00	5	004310006
7x1	5,0	50	18	28,00	5	004310007

M	mm	L	L1	€	Icon	Icon
8x1,25	5,0	56	22	25,50	3	004310008
10x1,5	6,0	70	25	31,50	3	004310010
12x1,75	7,0	75	30	47,50	3	004310012
14x2	9,0	80	32	66,50	1	004310014
16x2	9,0	80	32	75,00	1	004310016
18x2,5	11,0	95	40	112,50	1	004310018
20x2,5	12,0	95	40	120,50	1	004310020
22x2,5	12,0	100	40	172,50	1	004310022
24x3	14,5	110	50	194,50	1	004310024



431/SP21	€	Icon	Icon
M 3-4-5-6-8-10-12	236,00	1	004310201
431/SPV	27,00	1	004310202

433

serie di 2 maschi a mano
sgrossatore e finitore
passo fine, in acciaio al cromo



DIN 2181 UNI 4535

M	mm	L	L1	€	Icon	Icon
6x0,75	4,5	48	16	9,40	5	004330201
7x0,75	4,5	56	18	11,70	5	004330202
8x0,75	5,0	50	16	11,70	5	004330203
8x1	5,0	56	16	11,70	5	004330204
9x0,75	6,0	63	22	15,30	5	004330205
9x1	6,0	63	22	15,30	5	004330206
10x0,75	6,5	63	18	15,30	5	004330207
10x1	6,5	63	18	15,30	5	004330208
10x1,25	6,5	63	18	15,30	5	004330209
11x0,75	7,0	70	25	20,60	3	004330210
11x1	7,0	70	25	20,60	3	004330211
11x1,25	7,0	70	25	20,60	3	004330212
12x0,75	7,0	70	20	20,00	3	004330213
12x1	7,0	70	20	20,00	3	004330214
12x1,25	7,0	70	20	20,00	3	004330215
12x1,5	7,0	70	20	20,00	3	004330216
14x1	8,0	80	32	26,50	1	004330217
14x1,25	8,0	80	32	26,50	1	004330218
14x1,5	8,0	80	32	26,50	1	004330219
16x1	10,0	80	32	31,00	1	004330220
16x1,5	10,0	80	32	31,00	1	004330221
18x1,5	11,0	95	40	36,50	1	004330222
18x2	11,0	80	25	47,50	1	004330223
20x1,5	14,5	80	22	54,00	1	004330224
22x1,5	14,5	80	22	64,50	1	004330225
24x1,5	14,5	80	22	75,00	1	004330226
24x2	14,5	80	22	74,50	1	004330227

433ASF

serie di 2 maschi a mano
UNF, passo fine
in acciaio al cromo



ANSI B1.1

UNF	mm	L	L1	€	Icon	Icon
1/4x28	4,9	70	30	11,90	5	004330301
5/16x24	4,9	70	30	14,20	5	004330302
3/8x24	5,5	75	35	16,10	3	004330303
7/16x20	6,2	80	40	20,40	3	004330304
1/2x20	7,0	85	45	26,00	3	004330305
9/16x18	9,0	90	45	32,50	3	004330306
5/8x18	9,0	100	47	36,50	3	004330307
3/4x16	11,0	110	50	49,50	3	004330308
7/8x14	14,5	120	60	64,00	1	004330309
1"x12	16,0	130	60	87,50	1	004330310

433ASG

serie di 2 maschi a mano
filettatura **GAS** cilindrica
in acciaio al cromo



DIN 5157

GAS	mm	L	L1	€	Icon	Icon
1/8x28	5,5	65	18	17,00	1	004330401
1/4x19	9,0	70	24	21,70	1	004330402
3/8x19	9,0	75	25	26,50	1	004330403
1/2x14	12,0	80	31	37,00	1	004330405
3/4x14	16,0	90	33	61,00	1	004330408
1"x11	20,0	100	39	99,00	1	004330410

434

serie di 2 maschi a mano
sgrossatore e finitore
passo fine, in acciaio HSS



DIN 2181 UNI 4535

M	mm	L	L1	€	Icon	Icon
6x0,75	4,5	48	16	27,00	5	004340001
8x0,75	5,0	56	16	31,50	5	004340003
8x1	5,0	56	16	31,50	5	004340004
10x0,75	6,5	63	18	39,50	5	004340007
10x1	6,5	63	18	39,50	5	004340008
10x1,25	6,5	63	18	39,50	5	004340009
12x1	7,0	70	20	42,50	3	004340014
12x1,25	7,0	70	20	42,50	3	004340015
12x1,5	7,0	70	20	42,50	3	004340016
13x1,5	9,0	70	20	89,00	1	004340017
14x1	9,0	70	20	53,00	1	004340018
14x1,25	9,0	70	20	53,00	1	004340019
14x1,5	9,0	70	20	45,50	1	004340020
15x1,5	9,0	70	20	89,00	1	004340021
16x1	9,0	70	20	57,00	1	004340022
16x1,5	9,0	70	20	49,00	1	004340023
18x1,5	11,0	80	22	63,50	1	004340024
18x2	11,0	90	25	77,00	1	004340025
20x1,25	12,0	80	22	109,00	1	004340026
20x1,5	12,0	80	22	67,50	1	004340027
20x2	12,0	90	25	83,50	1	004340028



M	mm	L	L1	€		
22x1,5	14,5	80	22	97,00	1	004340029
24x1	14,5	80	22	129,50	1	004340030
24x1,5	14,5	80	22	109,00	1	004340031
24x2	14,5	80	22	114,00	1	004340032

435

giraschi regolabili
corpo in acciaio



DIN 1814

	mm	L	€		
435/0	2÷5 M1÷M8	170	18,30	3	004350007
435/1	2÷6 M1÷M10	200	22,00	2	004350009
435/1,5	2,5÷6 M1÷M12	200	23,30	2	004350011
435/2	3÷7 M4÷M12	260	33,00	2	004350013
435/3	4÷12 M5÷M20	345	55,00	1	004350020
435/4	5,5÷16 M9÷M27	430	85,50	1	004350027
435/5	7÷18 M13÷M32	770	193,50	1	004350032

435G

giraschi regolabili
corpo in lega leggera



DIN 1814

	mm	L	€		
435G/0	2÷5 M1÷M8	130	13,00	5	004350108
435G/1	2÷6 M1÷M10	190	15,90	5	004350110
435G/1,5	2÷7 M2÷M12	175	16,60	5	004350112
435G/2	3,4÷7 M4÷M12	280	27,50	5	004350114
435G/3	4,9÷12 M5÷M20	380	44,00	2	004350121
435G/4	7÷16 M11÷M27	500	70,00	2	004350127
435G/5	7÷18 M13÷M32	700	110,50	1	004350132
435G/6	11÷24 M18÷M42	800	182,50	1	004350142

436

giraschi a cricchetto
reversibile

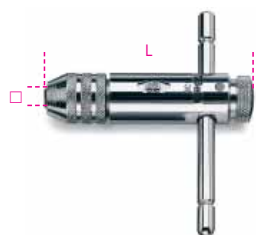

	mm	L	€		
436/1	2÷5 M3÷M8	85	30,50	5	004360002
436/2	4,6÷8 M5÷M12	110	38,50	5	004360004

436L

giraschi a cricchetto
reversibile, tipo lungo



	mm	L	€		
436L/1	2÷5 M3÷M8	245	48,00	2	004360012
436L/2	4,6÷8 M5÷M12	295	56,00	2	004360014

436R

morsetti di ricambio per 436 e 436L

	€		
436R/1	5,65	1	004360022
436R/2	6,40	1	004360024

437P

ravvifafiletti
per ripristino di filettature interne ed esterne,
destre e sinistre

P 0,80-1,00-1,25-1,50-1,75-2,00-2,50-3,00 mm



L	€		
mm 230	49,50	1	004370003

437C

set ripristino filettature candela danneggiate,
M14x1,25 mm

• altezza elicoidi: 8,40 - 12,40 - 16,40 mm. (5 pz per misura)



	€		
437C	129,00	1	004370100

437C/...

elicoidi in acciaio inossidabile per 437C



H	€		
mm 8.4	33,00	1	004370108
12.4	33,00	1	004370112
16.4	33,00	1	004370116

I prezzi indicati sono relativi a 10 pezzi

437C/RM14

maschi filetti candele M14x1,25



	€		
437C/RM14	107,00	1	004370124

437K/8

assortimento per ripristino
filetti semiassi

• permette di ripassare e ravvivare il filetto originale
Incluse nel kit:
• misure metriche:
20x1,25 - 20x1,5 - 22x1,00 - 22x1,5 - 24x1,5 - 24x2,00
• misure in pollici
3/4x20 - 13/16x20



32 mm

	€		
437K/8	85,00	1	004370020

200x110x30 mm

437K/9

assortimento per ripristino filettature
maschio e femmina, viti fissaggio ruote

permette di ripassare e ravvivare il filetto originale

Inclusi nel kit:
• maschi:
M12x1,25 - M12x1,5 - M12x1,75 - M14x1,5
• filiere:
M12x1,25 - M12x1,5 - M14x1,5



12 - 24 mm

	€		
437K/9	89,50	1	004370029

161x123x50 mm

437K/12

assortimento per ripristino filetti semiassi

permette di ripassare e ravvivare il filetto originale

Incluse nel kit:

• misure metriche:

M16x1,0 - M16x1,5 - M20x1,0 - M20x1,5 - M22x1,5 - M24x1,5 -

M24x2,0 - M27x2,0

• misure in pollici:

3/4x16 - 3/4x20 - 13/16x20 - 27/32x20



○ 32 - 35 mm

437K/12 € 107,00 1 004370032

≡ 220x118x52 mm

437K/16

assortimento per il ripristino delle filettature danneggiate dei supporti pinze freno M9x1,25



437K/16 € 120,00 1 004370016

≡ 210x150x50 mm

437K/33

assortimento per il ripristino delle filettature candelette danneggiate

Boccole:

M8x1,0 - M10x1,0 - M10x1,25 - M12x1,25

Maschi:

M8x1,0 - M10x1,0 - M10x1,25 - M12x1,0 - M12x1,25 - M14x1,25



437K/33 € 298,00 1 004370133

≡ 210x150x50 mm

437U/09

assortimento per il ripristino delle filettature danneggiate



25 x M5, M6, M8, M10
10 x M12

437U/09 € 360,00 1 004370550

M5X0,8
M6X1,0
M8X1,25
M10X1,5
M12X1,75

≡ 370x230x55 mm - 2 Kg

437U/E-M...

elicoidi in acciaio inossidabile



	H mm	€		
M5	7.5	19,20	1	004370555
M6	9	19,20	1	004370556
M8	12	26,50	1	004370558
M10	15	35,00	1	004370560
M12	18	21,90	1	004370562

I prezzi indicati sono relativi a 25 pezzi
(10 per la misura M12)

437U/PM

punte e maschi per 437U/09



M5	€ 36,00	1	004370565
M6	€ 37,50	1	004370566
M8	€ 50,50	1	004370568
M10	€ 66,50	1	004370570
M12	€ 83,00	1	004370572

438A

serie di punte per forare, filettare e svasare; in acciaio HSS

- M3 - M4 - M5 - M6 - M8 - M10
- con portainseri magnetico



1/4
S MAX mm = Ø mm

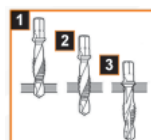

438A € 121,00 1 004380010

438...

punte per forare, filettare e svasare

in acciaio HSS, attacco 1/4"

1/4



	S max mm	€		
M3	3	23,30	2	004380103
M4	4	23,30	2	004380104
M5	5	23,30	2	004380105
M6	6	23,30	2	004380106
M8	8	26,50	2	004380108
M10	10	26,50	2	004380110

440

filiere tonde passo grosso
in acciaio al cromo

R ≤ 600 N/mm²
HRC ~ 60±61



UNI 4535
DIN 223

M	Ø x S mm	€		
2x0,4	25,4 x 9	18,40	5	004400002
3x0,5	25,4 x 9	13,50	5	004400003
4x0,7	25,4 x 9	13,50	5	004400004
5x0,8	25,4 x 9	11,60	5	004400005
6x1	25,4 x 9	11,60	5	004400006
7x1	25,4 x 9	11,60	5	004400007
8x1,25	25,4 x 9	11,60	5	004400008
9x1,25	25,4 x 9	11,60	5	004400009
10x1,5	25,4 x 9	11,60	5	004400010
12x1,75	25,4 x 9	11,60	5	004400012

440A

filiere tonde passo grosso
in acciaio al cromo

R ≤ 600 N/mm²
HRC ~ 60±61



UNI 4535
DIN 223

M	Ø x S mm	€		
10x1,5	38,1 x 14	16,60	3	004400110
11x1,5	38,1 x 14	16,60	3	004400111
12x1,75	38,1 x 14	16,60	3	004400112
14x2	38,1 x 14	16,60	3	004400114
16x2	38,1 x 14	16,60	3	004400116
18x2,5	38,1 x 14	19,30	3	004400118
20x2,5	38,1 x 14	21,30	3	004400120

440B

filiera tonde **passo grosso**
in acciaio al cromo

R ≤ 600 N/mm²
HRC ~ 60÷61



UNI 4535
DIN 223

M	Ø x S mm	€	5	3
18x2,5	50,8 x 16	29,50	3	004400122
20x2,5	50,8 x 16	31,00	3	004400124
22x2,5	50,8 x 16	33,50	3	004400126
24x3	50,8 x 16	34,00	3	004400128

440ASW

filiera tonde **Whitworth**
in acciaio al cromo

R ≤ 600 N/mm²



UNI EN 22568
DIN 223

BSW	Ø x S mm	€	5	3
1/8x40	25,4 x 9	15,70	5	004400201
5/32x32	25,4 x 9	15,70	5	004400202
3/16x24	25,4 x 9	14,00	5	004400203
1/4x20	25,4 x 9	14,00	5	004400204
5/16x18	25,4 x 9	14,00	5	004400205
3/8x16	38,1 x 14	20,00	3	004400206
7/16x14	38,1 x 14	20,00	3	004400207
1/2x12	38,1 x 14	20,60	3	004400208
9/16x12	38,1 x 14	20,60	3	004400209
5/8x11	50,8 x 16	36,00	3	004400210
3/4x10	50,8 x 16	36,00	3	004400211
7/8x9	50,8 x 16	41,50	3	004400212
1"x8	50,8 x 16	41,50	3	004400213

440ASC

filiera tonde, **UNC**
passo grosso, in acciaio al cromo

R ≤ 600 N/mm²



UNI EN 22568
DIN 223

UNC	Ø x S mm	€	5	3
1/4x20	25,4 x 9	13,90	5	004400221
5/16x18	25,4 x 9	13,90	5	004400222
3/8x16	38,1 x 14	19,30	3	004400223
7/16x14	38,1 x 14	19,30	3	004400224
1/2x13	38,1 x 14	19,30	3	004400225
9/16x12	38,1 x 14	19,30	3	004400226
5/8x11	50,8 x 16	40,50	3	004400227
3/4x10	50,8 x 16	40,50	3	004400228
7/8x9	50,8 x 16	40,50	3	004400229
1"x8	50,8 x 16	40,50	3	004400230

440ASF

filiera tonde, **UNF**
passo fine, in acciaio al cromo

UNI EN 2258
DIN 223

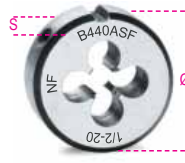

UNF	Ø x S mm	€	5	3
1/4x28	25,4 x 9	14,70	5	004400241
5/16x24	25,4 x 9	14,70	5	004400242
3/8x24	38,1 x 14	21,00	3	004400243
7/16x20	38,1 x 14	21,00	3	004400244
1/2x20	38,1 x 14	21,00	3	004400245
9/16x18	38,1 x 14	21,00	3	004400246
5/8x18	50,8 x 16	42,50	3	004400247
3/4x16	50,8 x 16	42,50	3	004400248
7/8x14	50,8 x 16	42,50	3	004400249
1"x12	50,8 x 16	42,50	3	004400250

440ASG

filiera tonde, filettatura **GAS** cilindrica
in acciaio al cromo

R ≤ 600 N/mm²

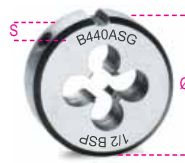

UNI EN 24231
DIN 223

GAS	Ø x S mm	€	5	3
1/8x28	38,1 x 14	16,60	3	004400255
1/4x19	38,1 x 14	16,60	3	004400256
3/8x19	38,1 x 14	16,60	3	004400257
1/2x14	50,8 x 16	34,00	3	004400259
3/4x14	50,8 x 16	34,00	3	004400260
1"x11	63,5 x 19	66,50	3	004400261

441

filiera tonde **passo fine**
in acciaio al cromo

R ≤ 600 N/mm²
HRC ~ 60÷61

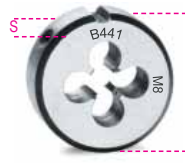

UNI 4535
DIN 223

M	Ø x S mm	€	5	3
6x0,75	25,4 x 9	14,00	5	004410004
7x0,75	25,4 x 9	14,00	5	004410005
8x0,75	25,4 x 9	14,00	5	004410006
8x1	25,4 x 9	14,00	5	004410007
9x0,75	25,4 x 9	14,00	5	004410008
9x1	25,4 x 9	14,00	5	004410009

441A

filiera tonde **passo fine**
in acciaio al cromo

R ≤ 600 N/mm²
HRC ~ 60÷61

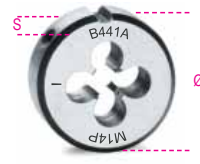

UNI 4535
DIN 223

M	Ø x S mm	€	5	3
10x0,75	38,1 x 14	21,00	3	004410100
10x1	38,1 x 14	21,00	3	004410101
10x1,25	38,1 x 14	21,00	3	004410102
11x0,75	38,1 x 14	21,00	3	004410103
11x1	38,1 x 14	21,00	3	004410104
11x1,25	38,1 x 14	21,00	3	004410105
12x0,75	38,1 x 14	21,00	3	004410106
12x1	38,1 x 14	21,00	3	004410107
12x1,25	38,1 x 14	21,00	3	004410108
12x1,5	38,1 x 14	21,00	3	004410109
14x1	38,1 x 14	21,00	3	004410110
14x1,25	38,1 x 14	21,00	3	004410111
14x1,5	38,1 x 14	21,00	3	004410112
16x1	38,1 x 14	21,00	3	004410113
16x1,5	38,1 x 14	21,00	3	004410114
18x1,5	38,1 x 14	21,00	3	004410115

441B

filiera tonde **passo fine**
in acciaio al cromo

R ≤ 600 N/mm²
HRC ~ 60÷61

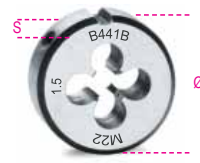

UNI 4535
DIN 223

M	Ø x S mm	€	5	3
18x1,5	50,8 x 16	39,00	3	004410117
18x2	50,8 x 16	39,00	3	004410118
20x1,5	50,8 x 16	39,50	3	004410119
22x1,5	50,8 x 16	41,50	3	004410120
24x1,5	50,8 x 16	42,00	3	004410121
24x2	50,8 x 16	42,00	3	004410122



442

filiere tonde **passo grosso**
in acciaio HSS

HRC ~ 62+63
AISI M2



UNI EN 22568
DIN 223

M	ØxS mm	€		
3x0,5	20x5	16,30	3	004420003
4x0,7	20x5	16,30	3	004420004
5x0,8	20x7	16,60	3	004420005
6x1	20x7	16,60	3	004420006
7x1	25x9	18,50	3	004420007
8x1,25	25x9	18,50	3	004420008
10x1,5	30x11	21,00	3	004420010
12x1,75	38x14	35,50	3	004420012
14x2	38x14	45,50	1	004420014
16x2	45x18	57,50	1	004420016
18x2,5	45x18	61,00	1	004420018
20x2,5	45x18	61,00	1	004420020

443

filiere tonde, **passo fine**
in acciaio HSS

HRC 62+63
AISI M2



UNI EN 22568
DIN 223

M	ØxS mm	€		
6x0,75	20x7	28,00	1	004430107
8x0,75	25x9	31,00	1	004430110
8x1	25x9	29,50	1	004430111
10x0,75	30x11	38,00	1	004430113
10x1	30x11	34,00	1	004430114
10x1,25	30x11	34,00	1	004430115
12x1	38x10	55,50	1	004430116
12x1,25	38x10	55,50	1	004430117
12x1,5	38x10	55,50	1	004430118
13x1,5	38x10	66,00	1	004430119
14x1	38x10	55,50	1	004430120
14x1,25	38x10	55,50	1	004430121
14x1,5	38x10	55,50	1	004430122
15x1,5	38x10	74,00	1	004430123
16x1	45x14	82,00	1	004430124
16x1,5	45x14	82,00	1	004430125
18x1,5	45x14	82,00	1	004430127
20x1,25	45x14	84,50	1	004430129
20x1,5	45x14	84,50	1	004430130
20x2	45x14	84,50	1	004430131
22x1,5	55x16	102,00	1	004430132
24x1	55x16	105,50	1	004430133
24x1,5	55x16	105,50	1	004430135
24x2	55x16	111,50	1	004430136

444

girafiliera, corpo in acciaio



EN 22568
DIN 225

	Ø mm	L mm	€		
444	20x5	190	22,10	5	004440005
444/0	20x7	190	22,10	5	004440007
444/1	25,4x9,5	210	23,10	5	004440025
444/1A	25x9	215	23,70	5	004440027
444/1B	30x11	250	27,50	5	004440030
444/C	38x10	310	35,00	3	004440033
444/1C	38x14	310	35,00	3	004440035
444/2	38,1x12,7	300	36,00	3	004440038
444/1D	45x14	445	49,00	1	004440045
444/2D	45x18	445	49,00	1	004440046
444/3	50,8x15,9	520	70,50	1	004440050
444/4	55x16	495	70,50	1	004440055
444/5A	63,5x19	520	121,50	1	004440057

444G

girafiliera, corpo in lega leggera



UNI EN 22568
DIN 225

	Ø mm	L mm	€		
444G/A	16x5	160	10,40	5	004440103
444G	20x5	185	12,00	5	004440105
444G/0	20x7	185	12,00	5	004440107
444G/1	25,4x9,5	215	14,60	5	004440125
444G/1A	25x9	215	14,60	5	004440127
444G/1B	30x11	265	18,80	5	004440130
444G/C	38x10	315	27,50	3	004440133
444G/1C	38x14	315	27,50	3	004440135
444G/2	38,1x12,6	310	27,50	3	004440138
444G/1D	45x14	450	36,00	1	004440145
444G/2D	45x18	450	37,00	1	004440146
444G/3	50,8x16	485	38,50	1	004440150
444G/4	55x16	560	46,50	1	004440155
444G/5A	63,5x19	630	82,00	1	004440163
444G/6	65x18	630	87,00	1	004440165



446/C30

assortimento di maschi e filiere
in acciaio al cromo e accessori
in cassetta di legno



446/C30 € 337,00 1 004460055

325x220x35 mm - 3,2 Kg

430 M mm	440 M mm		
3x0,5	3x0,5	435/1,5	444/1
4x0,7	4x0,7		
5x0,8	5x0,8		
6x1	6x1		
8x1,25	8x1,25		
10x1,5	10x1,5		
12x1,75	12x1,75		

446/C48

assortimento di maschi e filiere
in acciaio al cromo e accessori
in cassetta di legno



446/C48 € 639,00 1 004460057

580x300x50 mm - 5 Kg

430 M mm	440 M mm	440A M mm		
3x0,5	3x0,5	10x1,5	435/1	444/1
4x0,7	4x0,7	12x1,75	435/3	444/2
5x0,8	5x0,8	14x2		
6x1	6x1	16x2		
8x1,25	8x1,25	18x2,5		
10x1,5		20x2,5		
12x1,75				
14x2				
16x2				
18x2,5				
20x2,5				

446/C110

assortimento di maschi e filiere
in acciaio al cromo e accessori
per autoriparazione
in cassetta di legno



446/C110 € 924,00 1 004460060

500x337x60 mm - 8,1 Kg

430	433	440/440A	441/441A
M	M	M	M
mm	mm	mm	mm
2x0,4	6x0,75	2x0,4	6x0,75
3x0,5	7x0,75	3x0,5	7x0,75
4x0,7	8x0,75	4x0,7	8x0,75
5x0,8	8x1	5x0,8	8x1
6x1	9x0,75	6x1	9x0,75
7x1	9x1	7x1	9x1
8x1,25	10x0,75	8x1,25	10x0,75
9x1,25	10x1	9x1,25	10x1
10x1,5	10x1,25	10x1,5	10x1,25
11x1,5	11x0,75	11x1,5	11x0,75
12x1,75	11x1	12x1,75	11x1
14x2	11x1,25	14x2	11x1,25
16x2	12x0,75	16x2	12x0,75
	12x1		12x1
	12x1,25		12x1,25
	12x1,5		12x1,5
	14x1		14x1
	14x1,25		14x1,25
	14x1,5		14x1,5
	16x1		16x1
	16x1,5		16x1,5
	18x1,5		18x1,5

435/0	444/1	436/1
435/3	444/2	

446ASF/C29

assortimento di maschi e filiere
in acciaio al cromo e accessori
filettatura **UNF**
in cassetta di legno



446ASF/C29 € 732,00 1 004460070

660x410x50 mm - 6 Kg

433ASF	440ASF		
1/4	1/4	435/1,5	444/1
5/16	5/16	435/3	444/2
3/8	3/8		444/3
7/16	7/16		
1/2	1/2		
9/16	9/16		
5/8	5/8		
3/4	3/4		

446ASW/C36

assortimento di maschi e filiere
in acciaio al cromo e accessori
filettatura **Whitworth**
in cassetta di legno



446ASW/C36 € 541,00 1 004460075

525x310x50 mm - 3,4 Kg

430ASW	440ASW		
1/8	1/8	435/1,5	444/1
5/32	5/32	435/2	444/2
3/16	3/16		
1/4	1/4		
5/16	5/16		
3/8	3/8		
7/16	7/16		
1/2	1/2		

446ASC/C37

assortimento di maschi e filiere
in acciaio al cromo e accessori
filettatura **UNC**
in cassetta di legno



446ASC/C37 € 784,00 1 004460080

660x410x50 mm - 6,7 Kg

430ASC	440ASC		
1/4	1/4	435/1,5	444/1
5/16	5/16	435/3	444/2
3/8	3/8		444/3
7/16	7/16		
1/2	1/2		
9/16	9/16		
5/8	5/8		
3/4	3/4		

446ASG/C23

assortimento di maschi e filiere
in acciaio al cromo e accessori
filettatura **GAS** cilindrica
in cassetta di legno



446ASG/C23 € 1.141,00 1 004460085

700x430x70 mm - 9,8 Kg

433ASG	440ASG		
1/8	1/8	435/3	444/2
1/4	1/4	435/5	444/3
3/8	3/8		444/5A
1/2	1/2		
3/4	3/4		
1"	1"		

Beta

447/C37

assortimento di maschi e filiere in acciaio HSS e accessori in cassetta di metallo



447/C37 € 682,00 1 004470055

380x185x35 mm - 3,9 Kg

431 M mm	442 M mm		
3x0,5	3x0,5	435/0	444
4x0,7	4x0,7	435/2	444/0
5x0,8	5x0,8		444/1A
6x1	6x1		444/1B
8x1,25	8x1,25		444/1C
10x1,5	10x1,5		
12x1,75	12x1,75		

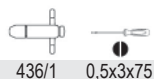

436/1 0,5x3x75

447/C53

assortimento di maschi e filiere in acciaio HSS e accessori in cassetta di metallo



447/C53 € 1.420,00 1 004470060

500x235x50 mm - 9 Kg

431 M mm	442 M mm			
3x0,5	3x0,5	435/1,5	444	436/1
4x0,7	4x0,7	435/3	444/0	436/2
5x0,8	5x0,8		444/1A	
6x1	6x1		444/1B	
8x1,25	8x1,25		444/1C	
10x1,5	10x1,5		444/2D	
12x1,75	12x1,75			
14x2	14x2			
16x2	16x2			
18x2,5	18x2,5			
20x2,5	20x2,5			

447/C70

assortimento di maschi e filiere in acciaio HSS e accessori per autoriparazione ed industria in cassetta di legno



447/C70 € 1.785,00 1 004470065

510x340x70 mm - 7,5 Kg

431 M mm	434 M mm	442 M mm	443 M mm
3x0,5	8x1	3x0,5	8x1
4x0,7	10x1,25	4x0,7	10x1,25
5x0,8	12x1,25	5x0,8	12x1,25
6x1	12x1,5	6x1	12x1,5
7x1	14x1,25	7x1	14x1,25
8x1,25	14x1,5	8x1,25	14x1,5
10x1,5	16x1,5	10x1,5	16x1,5
12x1,75	12x1,75		
14x2	14x2		
16x2	16x2		

435/0	444	436/1
435/3	444/0	
	444/1A	
	444/1B	
	444/C	
	444/1C	
	444/1D	
	444/2D	

450

seghe a tazza, bimetalliche in acciaio HSS-Co 8%

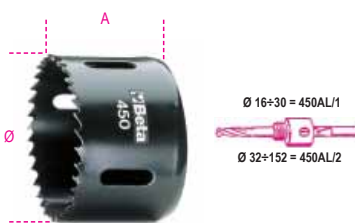

HSS-Co 8%

Ø mm	Ø	A mm	€		
16	(5/8)	57	18,00	1	004500016
17	(11/16)	57	18,00	1	004500017
19	(3/4)	51	18,00	1	004500019
20	-	51	18,00	1	004500020
21	(13/16)	51	18,00	1	004500021
22	(7/8)	51	18,00	1	004500022
24	(15/16)	51	18,00	1	004500024
25	(1")	51	19,80	1	004500025
27	(1"1/16)	51	20,50	1	004500027
29	(1"1/8)	51	20,50	1	004500029
30	(1"3/16)	51	20,50	1	004500030
32	(1"1/4)	51	20,50	1	004500032
33	(1"5/16)	51	21,00	1	004500033

Ø mm	Ø	A mm	€		
35	(1"3/8)	51	23,70	1	004500035
37	(1"7/16)	51	23,70	1	004500037
38	(1"1/2)	44	24,30	1	004500038
40	(1"9/16)	44	25,00	1	004500040
41	(1"5/8)	44	25,50	1	004500041
43	(1"11/16)	44	25,50	1	004500043
44	(1"3/4)	44	26,50	1	004500044
46	(1"13/16)	44	26,50	1	004500046
48	(1"7/8)	44	27,00	1	004500048
51	(2")	44	28,00	1	004500051
52	(2"1/16)	44	31,50	1	004500052
54	(2"1/8)	44	31,50	1	004500054
57	(2"1/4)	44	31,50	1	004500057
59	(2"5/16)	44	33,00	1	004500059
60	(2"3/8)	44	33,00	1	004500060
64	(2"1/2)	44	34,50	1	004500064
65	(2"9/16)	44	34,50	1	004500065
67	(2"5/8)	44	34,50	1	004500067
68	-	44	34,50	1	004500068
70	(2"3/4)	44	35,50	1	004500070
73	(2"7/8)	44	35,50	1	004500073
76	(3")	44	36,50	1	004500076
79	(3"1/8)	44	38,50	1	004500079
83	(3"1/4)	44	40,00	1	004500083
86	(3"3/8)	44	40,00	1	004500086
89	(3"1/2)	44	42,00	1	004500089
92	(3"5/8)	44	44,50	1	004500092
95	(3"3/4)	44	46,50	1	004500095
98	(3"7/8)	44	47,50	1	004500098
102	(4")	44	49,50	1	004500102
105	(4"1/8)	44	54,00	1	004500105
108	(4"1/4)	44	67,00	1	004500108
111	(4"3/8)	44	76,50	1	004500111
114	(4"1/2)	44	90,00	1	004500114
121	(4"3/4)	44	100,50	1	004500121
127	(5")	44	110,00	1	004500127
140	(5"1/2)	44	134,00	1	004500140
152	(6")	44	155,50	1	004500152

450AL

alberi per seghe a tazza



	Ø mm	L mm	€		
450AL/1	16÷30	54	22,00	1	004500210
450AL/2	32÷152	70	51,00	1	004500215

450AD

adattatore per alberi 450AL/1



	Ø mm	€		
450AD	32÷51	8,65	1	004500230



450PA/1

punta per centrare
in acciaio HSS
per alberi 450AL/1

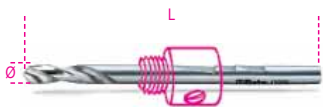

ØxL
mm
6,35x105 € 13,60 1 004500252

450PA/2

punta per centrare
in acciaio HSS
per alberi 450AL/2

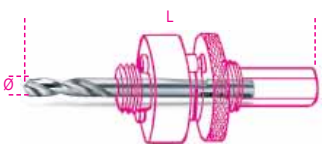

ØxL
mm
6,35x80 € 13,60 1 004500253

450PR

prolunga per seghe a tazza



L
mm
305 € 37,00 1 004500255

450/C9

assortimento di seghe a tazza
ed accessori per elettricisti



HSS-Co 8%

450/C9 € 261,00 1 004500305

450 Ø 22 - 29 - 35 - 44 - 51 - 64 mm
450AL /1 - /2
450AD
220x160x60 mm - 1,6 Kg

450/C13

assortimento di seghe a tazza
ed accessori per installatori



HSS-Co 8%

450/C13 € 327,00 1 004500310

450 Ø 19 - 22 - 29 - 35 - 38
44 - 51 - 57 - 64 mm
450AL /1 - /2
450PA/1
450AD
215x180x65 mm - 1,8 Kg

450/C15

assortimento di seghe a tazza
e accessori per elettricisti



HSS-Co 8%

450/C15 € 427,00 1 004500313

450 Ø 16 - 20 - 25 - 32 - 40
51 - 60 - 65 - 70 mm
450AL /1 - /2
450PA /1 - /2
450PR
450AD
420x185x60 mm - 3,2 Kg

450/C21

assortimento di seghe a tazza
ed accessori per uso industriale



HSS-Co 8%

450/C21 € 746,00 1 004500315

450 Ø 19 - 22 - 29 - 35 - 38
44 - 51 - 57 - 64 - 76
83 - 92 - 95 - 105 - 114 mm
450AL /1 - /2
450PA /1 - /2
450PR
450AD
420x280x60 mm - 7 Kg

451

frese a tazza
in acciaio HSS
interamente rettificate



Ø mm	L mm	D mm	€	1	004510012
12	85	8	27,00	1	004510012
13	85	8	27,00	1	004510013
14	85	8	27,50	1	004510014
15	85	10	27,50	1	004510015
16	85	10	27,50	1	004510016
17	85	10	27,50	1	004510017
18	85	10	27,50	1	004510018
19	85	10	28,00	1	004510019
20	85	10	29,50	1	004510020
21	85	10	32,00	1	004510021
22	85	10	33,50	1	004510022
23	85	10	35,00	1	004510023
24	85	10	36,00	1	004510024
25	85	10	37,00	1	004510025
26	90	10	39,00	1	004510026
27	90	10	40,00	1	004510027
28	90	10	41,00	1	004510028
29	90	10	42,50	1	004510029
30	90	10	43,00	1	004510030
31	90	10	45,50	1	004510031
32	90	10	46,50	1	004510032
33	90	10	48,00	1	004510033
34	90	10	49,50	1	004510034
35	90	10	51,00	1	004510035
36	85	10	53,00	1	004510036
37	85	10	54,00	1	004510037
38	85	10	55,00	1	004510038
39	85	10	56,50	1	004510039
40	85	10	57,50	1	004510040
41	85	10	59,00	1	004510041
42	85	10	62,00	1	004510042
43	85	10	64,00	1	004510043
44	85	10	65,00	1	004510044
45	85	10	66,50	1	004510045
46	85	10	66,50	1	004510046
47	85	10	68,50	1	004510047
48	85	10	72,00	1	004510048
49	85	10	74,00	1	004510049
50	85	10	74,00	1	004510050

451/C

assortimento di 8 frese a tazza
in acciaio HSS
interamente rettificate



451/C8 € 347,00 1 004510308

Ø 16-18-20-22-25-30-32-35 mm

270x225x70 mm

451GA

gambi per frese a tazza 451



M	Ø mm	L mm	D mm	€		
10x1,25	12÷14	57	8	15,40	1	004510101
12x1,25	15÷34	57	10	15,40	1	004510102
14x1,5	35÷50	57	10	18,80	1	004510105

451PA

punta pilota per frese a tazza 451
in acciaio HSS



Ø mm	L mm	€		
6	53	8,65	1	004510103

451PR

prolunga per frese a tazza 451



M	Ø mm	L mm	Ø1 mm	€		
12x1,25	15÷34	400	13	67,00	1	004510104
14x1,5	35÷50	400	13	67,00	1	004510108



452

frese a tazza
con inserti in metallo duro



Ø mm	Ø1 mm	€		
15	10	110,50	1	004520015
16	10	110,50	1	004520016
17	10	110,50	1	004520017
18	10	110,50	1	004520018
19	10	110,50	1	004520019
20	10	110,50	1	004520020
21	10	110,50	1	004520021
22	10	110,50	1	004520022
23	10	110,50	1	004520023
24	10	110,50	1	004520024
25	10	110,50	1	004520025
26	10	124,50	1	004520026
27	10	124,50	1	004520027
28	10	124,50	1	004520028
29	10	124,50	1	004520029
30	10	124,50	1	004520030
31	10	150,00	1	004520031
32	10	150,00	1	004520032
33	10	150,00	1	004520033
34	10	150,00	1	004520034
35	10	150,00	1	004520035
36	10	174,00	1	004520036
37	10	174,00	1	004520037
38	10	174,00	1	004520038
39	13	174,00	1	004520039
40	13	174,00	1	004520040
41	13	196,50	1	004520041
42	13	196,50	1	004520042
43	13	196,50	1	004520043
44	13	196,50	1	004520044
45	13	196,50	1	004520045
46	13	221,00	1	004520046
47	13	221,00	1	004520047
48	13	221,00	1	004520048
49	13	221,00	1	004520049
50	13	221,00	1	004520050
55	13	251,00	1	004520055
60	13	333,00	1	004520060
65	13	333,00	1	004520065
70	13	388,00	1	004520070
75	13	423,00	1	004520075
80	13	459,00	1	004520080
85	13	518,00	1	004520085
90	13	549,00	1	004520090

452GA

gambi per frese a tazza 452



	Ø mm	€		
452GA/1	15÷21	13,70	1	004520125
452GA/2	22÷38	16,00	1	004520126
452GA/3	39÷100	19,10	1	004520127

460

frese perforatrici a tazza per edilizia

- Per calcestruzzo, cemento, pietre naturali e artificiali
- Profondità massima di foratura 60 mm

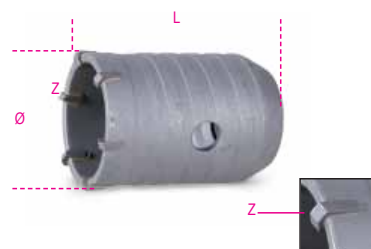

Ø mm	L mm	Z	€		
50	75	6	56,50	1	004600050
60	75	6	67,00	1	004600060
65	75	6	70,00	1	004600065
80	75	6	104,00	1	004600080
90	75	6	110,00	1	004600090
100	75	8	135,00	1	004600100
112	75	8	154,50	1	004600112
125	80	10	192,00	1	004600125
150	80	12	259,00	1	004600150

460PP

punta pilota per frese a tazza per edilizia 460



Ø mm	L mm	€		
8	120	6,40	1	004600201

460G

gambi per frese perforatrici a tazza 460



L mm	€		
220	35,00	1	004600222
370	48,50	1	004600237
460	77,00	1	004600246

MOLTIPLICATORI DI COPPIA

I moltiplicatori di coppia sono strumenti indispensabili per serrare dadi e viti con momenti torcenti più alti di quelli consentiti dalla forza dell'operatore in spazi limitati o poco accessibili. Evitano l'uso di ingombranti e rischiose prolunghie offrendo assoluta sicurezza.

La gamma di moltiplicatori Beta offre soluzioni e capacità diverse fino a un valore massimo di **9500 Nm**, con rapporti di moltiplicazione che arrivano fino a 135:1. Molti modelli, soprattutto quelli di maggior potenza, sono dotati di un dispositivo antiritorno in due sensi, per evitare che le tensioni accumulate si scarichino pericolosamente sull'operatore. Ogni moltiplicatore Beta è accompagnato da un **certificato** che ne attesta il collaudo al valore massimo in condizioni ottimali d'impiego.

Istruzioni per un corretto impiego

Il moltiplicatore di coppia **deve essere utilizzato con una chiave dinamometrica** per poter sempre avere il controllo della coppia di uscita, inoltre occorre sempre utilizzare **chiavi a bussola macchina**.

I rapporti di ciascun moltiplicatore definiscono il **fattore di moltiplicazione** tra coppia di ingresso e coppia in uscita. Esempio: moltiplicatore con rapporto 5:1. Applicando 100 Nm in ingresso, impostati sulla chiave dinamometrica, troveremo in uscita 500 Nm come valore trasmesso al dado o alla vite.

Assicurarsi in ogni caso che tutti gli elementi coinvolti nel serraggio agiscano con un buon allineamento.

Evitare di usare **prolunghe**, che si torcono producendo un effetto molla che modifica i valori di coppia applicati.

Assicurarsi sempre che la **barra di reazione** del moltiplicatore sia fissata o appoggiata su una struttura resistente, in grado di sopportare la forza di reazione. Normalmente si utilizzano pareti sufficientemente rigide o viti vicine a quella su cui si agisce. La barra di reazione ruota sempre in direzione **opposta** al senso di serraggio.



Effettuare la manovra con azione fluida e continua.

La tensione accumulata nel serraggio deve essere scaricata ruotando in senso inverso il moltiplicatore, prima di disimpegnarlo; nel caso dei moltiplicatori con dispositivo antiritorno, azionando la leva di inversione.

Tutte queste prescrizioni sono da adottare anche nel caso di **svitamento**.

560/C3

moltiplicatore di coppia destrorso/sinistrorso
in valigetta di materiale plastico
rapporto 3,8:1
con dispositivo antiritorno

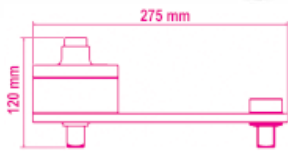

Nm	kgfm	lbf.ft	□	■	kg
1500	150	1110	1/2"	3/4"	3,9

	€		
560/C3	910,00	1	005600030
≡ 400x260x110 mm			

560/C3PLUS

moltiplicatore di coppia destrorso/sinistrorso
in valigetta di materiale plastico
rapporto 3,8:1
con dispositivo antiritorno

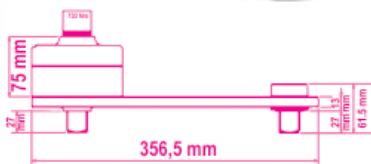

Nm	kgfm	lbf.ft	□	■	kg
2700	270	1991	3/4"	1"	7,5

	€		
560/C3PLUS	1.060,00	1	005600038
≡ 470x240x160 mm			

560/C2

moltiplicatore di coppia destrorso/sinistrorso e
accessori
rapporto 5:1
in cassetta di plastica
per uso intensivo

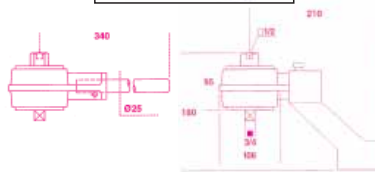

Nm	Kgfm	lbf.ft	□	■	kg
1300	130	960	1/2"	3/4"	3,8

	€		
560/C2	1.850,00	1	005600020
560/2	1.375,00	1	005600002
560/18	43,50	1	005600018
560/19	92,00	1	005600019
560/22	319,00	1	005600022
≡ 310x275x120 mm			

560/C4+

moltiplicatore di coppia destrorso/sinistrorso e
accessori
rapporto 5:1
con piede di reazione
per uso intensivo

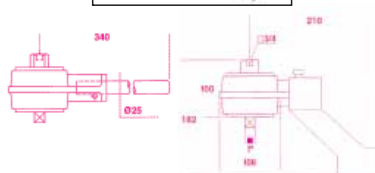

Nm	Kgfm	lbf.ft	□	■	kg
2700	270	2000	3/4"	1"	5

	€		
560/C4PLUS	1.815,00	1	005600042
560/4	1.435,00	1	005600004
560/18	43,50	1	005600018
560/22	319,00	1	005600022
≡ 310x275x120 mm			

560/C6

moltiplicatore di coppia destrorso/sinistrorso
in valigetta di materiale plastico
rapporto 6,5:1



Nm	kgfm	lbf.ft	□	■	kg
1500	150	1106	1/2"	3/4"	6

	€		
560/C6	947,00	1	005600160
≡ 400x260x110 mm			

560/C12

moltiplicatore di coppia destrorso/sinistrorso
in valigetta di materiale plastico
rapporto 12:1



Nm	kgfm	lbf.ft	□	■	kg
2500	250	1844	1/2"	1"	7

	€		
560/C12	1.360,00	1	005600210
≡ 400x260x110 mm			

561/1

moltiplicatore di coppia destrorso/sinistrorso
rapporto 5:1
con due piedi di reazione

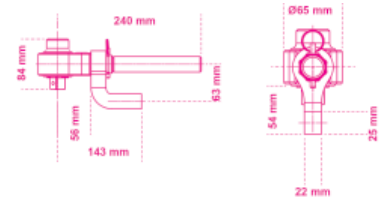

Nm	kgfm	lbf.ft	□	■	kg
1000	100	740	1/2"	3/4"	2,7

	€		
561/1	1.325,00	1	005610010
≡ 270x210x70 mm			

562-1/VA - 562-2/VA

moltiplicatori di coppia destrorsi/sinistrorsi
rapporto 5,2:1
in valigia 562VV-A



Nm	Kgfm	lbf.ft	□	■	D	A	L min	L max	█
1700	170	1250	3/4	1"	108	95	85	220	8,8

562-1/VA € 2.940,00 1 005620601

Nm	Kgfm	lbf.ft	□	■	D	A	L min	L max	█
3400	340	2500	3/4	1"	119	115	85	265	10,5

562-2/VA € 3.560,00 1 005620602

564-3R/V - 564-4R/V

moltiplicatori di coppia destrorsi/sinistrorsi
rapporto 25:1
con dispositivo antiritorno
in valigia



Nm	Kgfm	lbf.ft	□	■	D	A	L	█
4000	400	3000	1/2	1"	92	185	205	7,6

564-3R/V € 5.730,00 1 005640613

☞ 390x310x145 mm

Nm	Kgfm	lbf.ft	□	■	D	A	L	█
7000	700	5000	1/2	1 1/2"	120	200	210	13,2

564-4R/V € 6.770,00 1 005640614

☞ 500x435x170 mm

565-1R/VA - 565-2R/VA - 565-3R/VA

moltiplicatori di coppia destrorsi/sinistrorsi
rapporto 27:1
con dispositivo antiritorno
in valigia 562VV-A



Nm	Kgfm	lbf.ft	□	■	D	A	L min	L max	█
1700	170	1250	1/2	1"	108	125	80	215	11,2

565-1R/VA € 4.760,00 1 005650611

Nm	Kgfm	lbf.ft	□	■	D	A	L min	L max	█
3400	340	2500	1/2	1"	119	145	85	265	13,6

565-2R/VA € 6.210,00 1 005650612

Nm	Kgfm	lbf.ft	□	■	D	A	L min	L max	█
3400	340	2500	1/2	1 1/2"	119	145	85	265	14,2

565-3R/VA € 6.560,00 1 005650613

565-4R/VA

moltiplicatore di coppia destrorso/sinistrorso
rapporto 27:1
con dispositivo antiritorno
in valigia 565VV-B

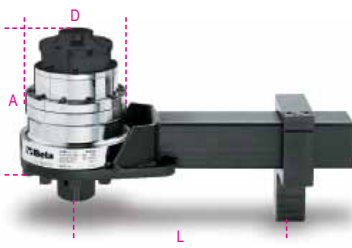

Nm	Kgfm	lbf.ft	□	■	D	A	L min	L max	█
6000	600	4500	1/2	1 1/2"	144	180	125	335	22,4

565-4R/VA € 7.410,00 1 005650614

565-5R/VA

moltiplicatore di coppia destrorso/sinistrorso
rapporto 27:1
con dispositivo antiritorno
in valigia 565VV-B



Nm	Kgfm	lbf.ft	□	■	D	A	L min	L max	█
9500	950	7000	3/4	1 1/2"	184	180	155	355	30,4

565-5R/VA € 12.610,00 1 005650615

567-4R/VA

moltiplicatore di coppia destrorso/sinistrorso
rapporto 135:1
con dispositivo antiritorno
in valigia 565VV-B

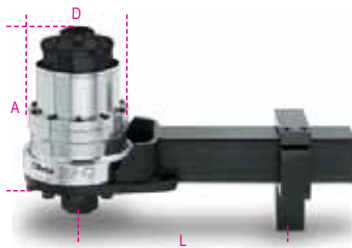

Nm	Kgfm	lbf.ft	□	■	D	A	L min	L max	█
6000	600	4500	1/2	1 1/2"	144	210	125	335	24,4

567-4R/VA € 8.230,00 1 005670614

567-5R/VA

moltiplicatore di coppia destrorso/sinistrorso
rapporto 135:1
con dispositivo antiritorno
in valigia 565VV-B

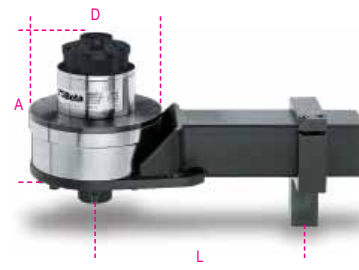

Nm	Kgfm	lbf.ft	□	■	D	A	L min	L max	█
9500	950	7000	1/2	1 1/2"	184	210	155	350	32,4

567-5R/VA € 14.130,00 1 005670615

562VV-A

valigia per moltiplicatori,
in polipropilene ad alta resistenza con spugna

Misure interne 380x270x180 mm



562VV-A € 252,00 1 005620501

562/1-562/2-564/3R
564/4R-565/1R-565/2R
565/3R

☞ 410x340x205 mm - █ 3,5 kg

565VV-B

valigia per moltiplicatori,
in polipropilene ad alta resistenza con spugna

Misure interne 480x370x205 mm



565VV-B € 340,00 1 005650502

565/4R-565/5R
567/4R-567/5R

☞ 520x435x230 mm - █ 5,4 kg



Le chiavi dinamometriche devono sempre essere manovrate impugnandole al centro dell'impugnatura, per non modificare il rapporto di leva. Devono essere utilizzate applicando una azione fluida e continua, evitando strappi.



La scala di regolazione deve essere riportata a zero dopo l'utilizzo per non compromettere la precisione di serraggio.

Per le chiavi della serie Zero-Reset questo non è necessario.



Beta offre una vasta gamma di chiavi con **quattro funzionamenti** differenti.

MODELLI A LETTURA DIRETTA

La coppia di serraggio esercitata viene trasmessa direttamente all'indice di lettura tramite la compressione di una molla elicoidale. La coppia applicata può essere letta in tempo reale grazie a una lancetta indicatrice. Una seconda lancetta può essere posizionata sul valore della coppia obiettivo. Al raggiungimento della coppia obiettivo, la seconda lancetta viene agganciata dalla lancetta principale e registra il picco massimo raggiunto. Garantiscono assoluta precisione e durata nel tempo

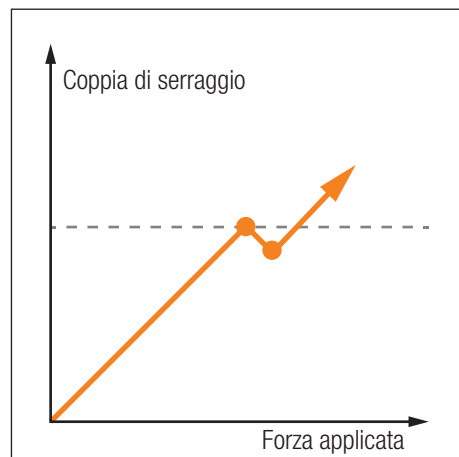

MODELLI A SCATTO

Sono i modelli più diffusi grazie alla loro praticità d'uso. La preselezione della coppia avviene rapidamente caricando la molla. La coppia aumenta all'aumentare della forza applicata. Al raggiungimento della coppia desiderata si ha un improvviso cedimento e per circa 3-5° la chiave non esercita alcuna coppia di serraggio. Se l'operatore non interrompe il movimento, la coppia continua a crescere, superando i valori desiderati.

MODELLI A DISINNESTO

Funzionano come i modelli a scatto, ma quando viene raggiunta la coppia si ha un vistoso cedimento (circa 20°) del braccio-leva. L'operatore ha quindi molto più margine per cessare l'applicazione della forza. Sono utilizzate normalmente per valori di coppia elevati con bracci di leva molto lunghi.

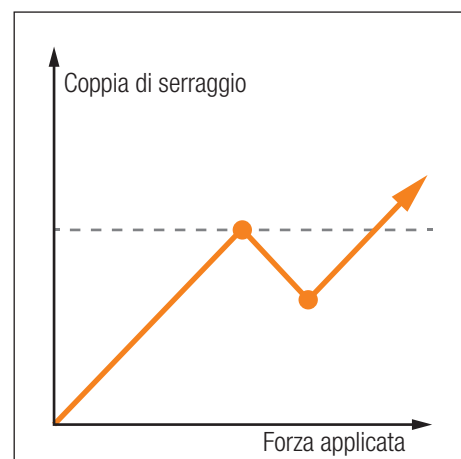
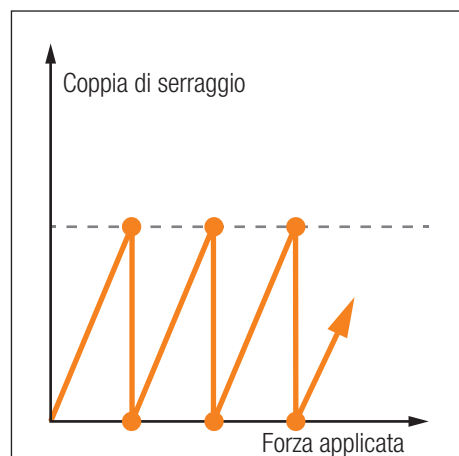

MODELLI A SLITTAMENTO

Al raggiungimento della coppia preselezionata, lo slittamento del meccanismo interrompe l'applicazione della coppia, provocando la rotazione "a vuoto" dell'utensile. In questo modo è impossibile effettuare serraggi con coppie superiori al desiderato. Continuando ad applicare la forza si ripete il medesimo ciclo. Sono ideali per operazioni in serie nel campo delle basse coppie (elettronica e micromeccanica), dove è necessario evitare di rompere componenti fragili o di piccole dimensioni.

CAMPI DI IMPIEGO CHIAVI DINAMOMETRICHE

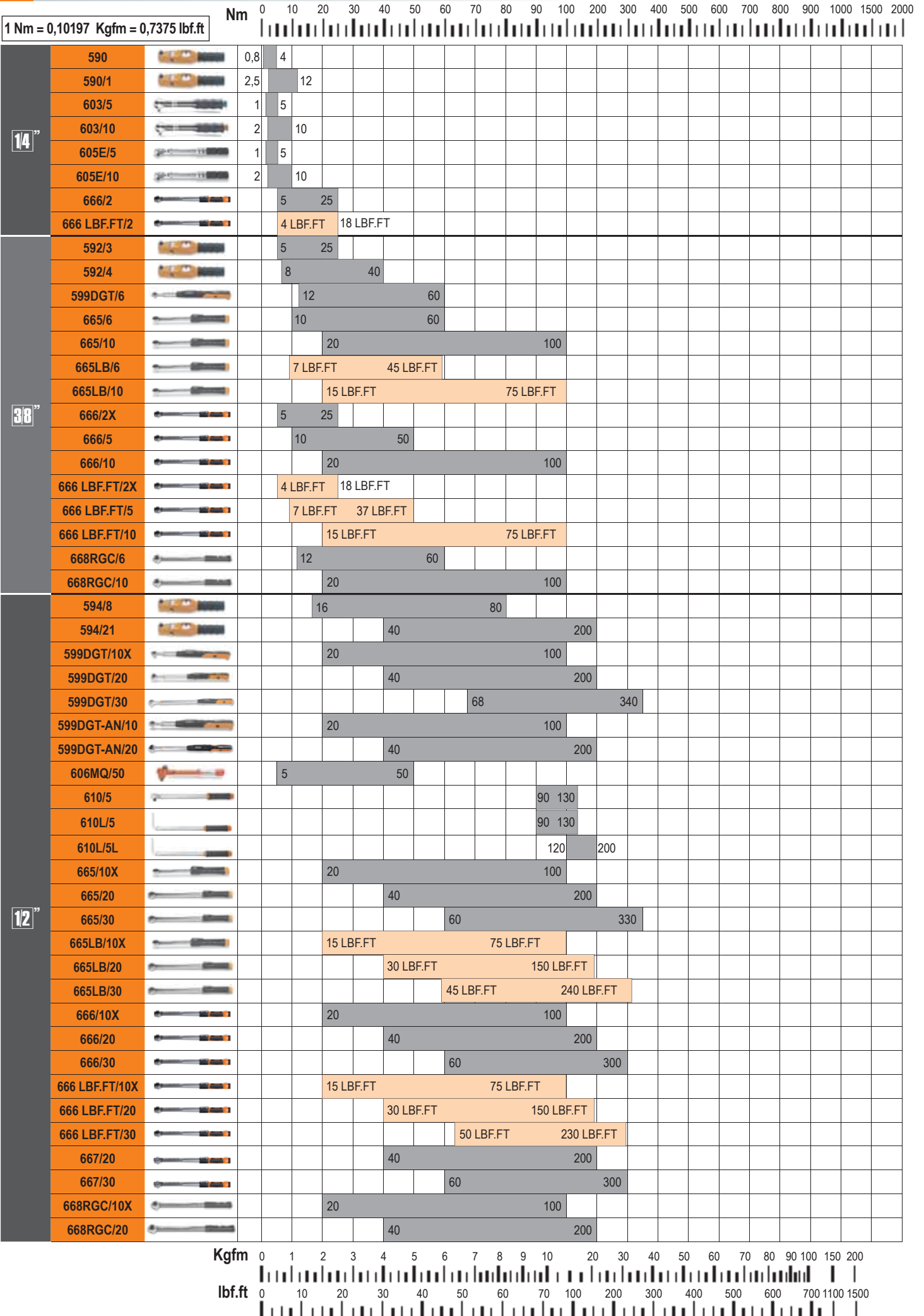

CAMPI DI IMPIEGO CHIAVI DINAMOMETRICHE

1 Nm = 0,10197 Kgfm = 0,7375 lbf.ft



Model	Min Torque [Nm]	Max Torque [Nm]
596/40SL	80	400
596/80SL	160	800
667/40	80	400
677/600 677C/600	120	600
677/800 677C/800	200	800
677/1000 677C/1000	300	1000
677C/1500	700	1500
678C/65	130	650
678C/100	300	1000
678C/150	500	1500
598/200SL	400	2000
677/CP2000	900	2000
604B/5	1	5
604B/10	2	10
668N/2	5	25
668N/5	10	50
668N/10	20	100
668N/20	40	200
668N/30	60	300
668RG/6	8	60
668RG/10	20	100
668RG/20	40	200
668RG/30	60	300
669N/2	5	25
669N/5	10	50
669N/10	20	100
669N/20	40	200
669N/20X	40	200
669N/30	60	300
669N/40	80	400
674/C50	100	500
674/C80	160	800
674/C100	200	1000

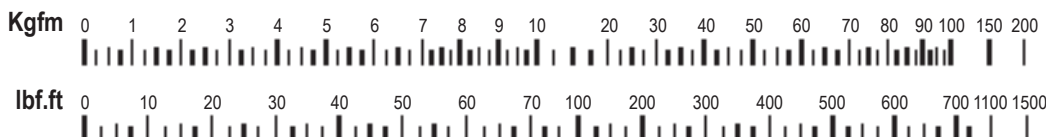

Calcolo della corretta coppia di serraggio

Il braccio di leva cambia per accessori che hanno lunghezza diversa da quella standard ($L_A \neq L_S$).
Per il calcolo della corretta coppia da impostare applicare la seguente formula

$$C = \frac{M \cdot (L_B + L_S)}{L_B + L_A} [N \cdot m]$$

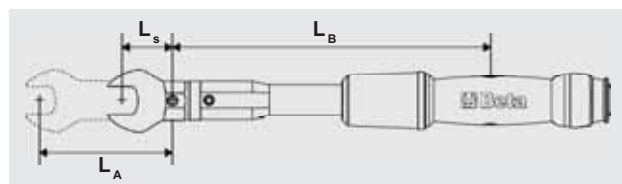

- C = coppia da impostare
- M = coppia desiderata
- L_A = lunghezza accessorio (vedi tabella caratteristiche accessori)
- L_B = lunghezza barra (vedi tabella caratteristiche barra dinamometrica)
- L_S = lunghezza accessorio standard (vedi tabella caratteristiche barra dinamometrica)

Beta

581

giravite dinamometrico a slittamento
non graduato
adatto a serraggi destrorsi
precisione di serraggio +/-6%
(per il settaggio della coppia usare
gli artt. 588 - 682)



UNI EN ISO 6789

Nm	gfm	O	g
1,2÷6	120÷600	1/4"	275

581 € 297,00 1 005810001

583

giravite dinamometrico a slittamento
adatto a serraggi destrorsi
precisione di serraggio +/-6%



UNI EN ISO 6789

Nm	gfm	O	g	kg
0,3÷1,5	30÷150	1/4"	240	0,05

583/1,5 € 334,00 1 005830015

Nm	gfm	O	g	kg
0,6÷3	60÷300	1/4"	240	0,1

583/3 € 334,00 1 005830030

Nm	gfm	O	g	kg
1,2÷6	120÷600	1/4"	350	0,2

583/6 € 334,00 1 005830060

583/C31

1 giravite dinamometrico, 8 chiavi a bussola
esagonali, 20 inserti per avvitatori e 2
accessori

1/4



583/C31 € 466,00 1 005830931

583/6	1.2 - 6 Nm
900	4-5-5,5-6-7-8-9-10 mm
860LP	0,6x4,5 - 1x5,5 - 1,2x6,5 mm
860PH	PH1 - PH2 (x2) - PH3
860PE	2-2,5-3-4-5 mm
860TX	T9-T10-T15-T20-T25-T27-T30-T40
882P/80	80 mm
892/0	● 1/4 ■ 1/4

270x120x45 mm - 1,2 kg

590 - 592

chiavi dinamometriche a lettura diretta
adatte a serraggi destrorsi e sinistrorsi
precisione di serraggio ± 4%

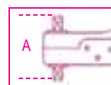

UNI EN ISO 6789

Nm	Kgfm	lbf.in	mm	A	L	kg	kg
0,8÷4	0,08÷0,4	7÷35	1/4	60	253	0,52	0,1

590 € 788,00 1 005900001

Nm	Kgfm	lbf.in	mm	A	L	kg	kg
2,5÷12,5	0,25÷1,25	21÷110	1/4	60	253	0,52	0,5

590/1 € 788,00 1 005900003

Nm	Kgfm	lbf.in	mm	A	L	kg	kg
5÷25	0,5÷2,5	44÷220	3/8	70	253	0,52	1,0

592/3 € 783,00 1 005920005

Nm	Kgfm	lbf.in	mm	A	L	kg	kg
8÷40	0,8÷4	72÷360	3/8	70	253	0,52	1,0

592/4 € 783,00 1 005920007

594

chiavi dinamometriche a lettura diretta
adatte a serraggi destrorsi e sinistrorsi
precisione di serraggio ± 4%

12"



UNI EN ISO 6789

Nm	Kgfm	lbf.ft	mm	A	L	kg	kg
16÷80	1,6÷8	12÷60	1/2	85	455	1,35	2,0

594/8 € 1.186,00 1 005940011

Nm	Kgfm	lbf.ft	mm	A	L	kg	kg
40÷200	4÷20	30÷160	1/2	85	530	1,40	5,0

594/21 € 1.186,00 1 005940015

Servizio di taratura
dinamometrica
a fine listino

596 - 598

chiavi dinamometriche a lettura diretta
adatte a serraggi destrorsi e sinistrorsi
precisione di serraggio ± 4%

Il raggiungimento della coppia prefissata
viene segnalato da una luce
e da un suono intermittente



UNI EN ISO 6789

Nm	Kgfm	lbf.ft	mm	A	L	kg	kg
80÷400	8÷40	60÷300	3/4	111	710	3,2	10

596/40SL € 1.960,00 1 005960010

Nm	Kgfm	lbf.ft	mm	A	L	kg	kg
160÷800	16÷80	120÷600	3/4	115	1025	4,85	20

596/80SL € 2.465,00 1 005960020

Nm	Kgfm	lbf.ft	mm	A	L	kg	kg
400÷2000	40÷200	300÷1500	1"	135	1930	16,70	50

598/200SL € 5.140,00 1 005980022





599DGT

chiave dinamometrica elettronica a lettura di coppia e angolo con cricchetto reversibile per serraggi destrorsi e sinistrorsi precisione di serraggio $\pm 2\%$ destrorso $\pm 3\%$ sinistrorso

- Doppia modalit  di misura: picco e traccia
- Il raggiungimento della coppia prefissata viene segnalato da avvisatori luminosi e da un suono intermittente
- Alimentazione con 2 batterie da 1,5V (include)



UNI EN ISO 6789

Nm	Kgfm	lbf.ft	■	D	A	L	█	⌘
12÷60	1,2÷6	8÷44	3/8	30	33	413	0,9	0,1

599DGT/6	417,00	1	005990003
----------	--------	---	-----------

Nm	Kgfm	lbf.ft	■	D	A	L	█	⌘
20÷100	2÷10	15÷80	1/2	30	37	413	0,9	0,1

599DGT/10X	429,00	1	005990010
------------	--------	---	-----------

Nm	Kgfm	lbf.ft	■	D	A	L	█	⌘
40÷200	4÷20	30÷150	1/2	40	43	520	2	0,1

599DGT/20	446,00	1	005990020
-----------	--------	---	-----------

Nm	Kgfm	lbf.ft	■	D	A	L	█	⌘
68÷340	6,8÷34	58÷280	1/2	40	43	640	2,35	0,1

599DGT/30	481,00	1	005990030
-----------	--------	---	-----------

599DGT-AN

chiave dinamometrica elettronica a lettura di coppia e angolo con cricchetto reversibile per serraggi destrorsi (precisione $\pm 2\%$) e sinistrorsi (precisione $\pm 3\%$)

- Tipologie di serraggio: coppia, angolo, coppia + angolo
- Doppia modalit  di misura: picco e traccia
- Il raggiungimento della coppia o dell'angolo prefissati vengono segnalati da avvisatori luminosi e da un suono intermittente
- Memorizzazione dei dati di serraggio (fino a 1600 valori)
- 9 valori di coppia/angolo preimpostabili
- Blocco di sicurezza dei tasti
- Possibilit  di associare la chiave a 16 utilizzatori tramite ID utente
- Tracciabilit  dei dati di serraggio. Il software permette di memorizzare data e ora, numero di serie dell'utensile, valore di serraggio impostato, valore raggiunto, e di associarli all'ID utente
- Impugnatura bimatereale antiscivolo
- Inclusi: 2 batterie AA - 1,5V, cavo USB e software



UNI EN 26789
ISO 6789

Nm	Kgfm	lbf.ft	■	D	A	L	█	⌘
20÷100	2÷10	15÷80	1/2	30	33	413	0,9	0,1

599DGT-AN/10	783,00	1	005990610
--------------	--------	---	-----------

Nm	Kgfm	lbf.ft	■	D	A	L	█	⌘
40÷200	4÷20	30÷150	1/2	40	43	520	1,3	0,1

599DGT-AN/20	826,00	1	005990620
--------------	--------	---	-----------

Servizio di taratura
dinamometria
a fine listino



600

attrezzi per serraggi angolari

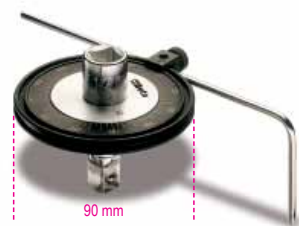

Model	□	■	€	⌘	⌘
600/1	1/2	1/2	167,00	1	006000001
600/2	3/4	3/4	189,00	1	006000002

601C

goniometro digitale per serraggi angolari, magnetico

il raggiungimento dell'angolo prefissato viene segnalato da avvisatori luminosi e da un suono intermittente



601C	224,50	1	006010100
------	--------	---	-----------

85x80x87 mm - 70 g

601CA

goniometro digitale per serraggi coppia ed angolo

il raggiungimento della coppia o dell'angolo prefissati viene segnalato da avvisatori luminosi e da un suono intermittente



Model	□	■	Nm	⌘	⌘
601CA	1/2"	1/2"	40÷200	0,1	397,00

120x90x120 mm - 240 g

603

chiavi dinamometriche a slittamento per serraggi destrorsi
precisione di serraggio $\pm 6\%$



UNI EN ISO 6789

Nm	Kgfm	lbf.in	1/4	A mm	L mm	g	0,05
1÷5	0,1÷0,5	10÷45	1/4	35	195	235	0,05

603/5 € 676,00 1 006030005

Nm	Kgfm	lbf.in	1/4	A mm	L mm	g	0,1
2÷10	0,2÷1,0	18÷90	1/4	35	195	235	0,1

603/10 € 692,00 1 006030010

604B

barre dinamometriche a disinnesto per serraggi destrorsi e sinistrorsi
precisione di serraggio $\pm 6\%$



UNI EN ISO 6789

Nm	kgfm	lbf.in	Ø mm	L mm	g	0,025
1÷5	0,1÷0,5	10÷45	8	220	290	0,025

604B/5 € 439,00 1 006040015

Nm	Kgfm	lbf.in	Ø mm	L mm	g	0,05
2÷10	0,2÷1,0	18÷90	8	220	300	0,05

604B/10 € 439,00 1 006040020

605E

chiavi dinamometriche a scatto con cricchetto reversibile per serraggi destrorsi e sinistrorsi
precisione di serraggio $\pm 6\%$



UNI EN ISO 6789

Nm	Kgfm	lbf.in	1/4	A mm	L mm	g	0,05
1÷5	0,1÷0,5	10÷45	1/4	20	190	180	0,05

605E/5 € 225,50 1 006050105

Nm	Kgfm	lbf.in	1/4	A mm	L mm	g	0,1
2÷10	0,2÷1,0	18÷90	1/4	20	190	180	0,1

605E/10 € 235,50 1 006050110

605DGT/2

chiave dinamometrica elettronica con cricchetto reversibile per serraggi destrorsi e sinistrorsi
precisione di serraggio $\pm 3\%$ destrorso $\pm 4\%$ sinistrorso

- Doppia modalità di misura: picco e traccia
- Il raggiungimento della coppia prefissata viene segnalato da avvisatori luminosi e da un suono intermittente
- Alimentazione con 1 batteria 1,5V AAA (inclusa)



Nm	Kgcm	lbf.ft	1/4	D mm	A mm	L mm	g	0,01
4÷20	10÷204	0,75÷14,75	1/4	20	20	210	175	0,01

605DGT/2 € 270,00 1 006050302

610/5

chiave dinamometrica a scatto con cricchetto reversibile per serraggi destrorsi
con 5 valori preregolati
precisione di serraggio $\pm 4\%$

Coppie selezionabili
90 - 100 - 110 - 120 - 130 Nm



UNI EN ISO 6789

Nm	1/2	D mm	A mm	L mm	g	10
90÷130	1/2	42	39	490	1330	10

610/5 € 188,00 1 006100025

610L/5

chiave dinamometrica a scatto con leva a L per serraggi destrorsi
con 5 valori preregolati
precisione di serraggio $\pm 4\%$

Coppie selezionabili
90 - 100 - 110 - 120 - 130 Nm



UNI EN ISO 6789

Nm	1/2	L mm	L1 mm	g	10
90÷130	1/2	470	80	1350	10

610L/5 € 167,00 1 006100125

610L/5L

chiave dinamometrica a scatto con leva a L per serraggi destrorsi
con 5 valori preregolati
precisione di serraggio $\pm 4\%$

Coppie selezionabili
120 - 140 - 160 - 180 - 200 Nm



UNI EN ISO 6789

Nm	1/2	L mm	L1 mm	g	20
120÷200	1/2	470	80	1400	20

610L/5L € 172,00 1 006100150

611

cricchetti reversibili per barre dinamometriche 604B/5 e 604B/10



1/4 L mm 42,5 € 158,00 1 006110001

**Servizio di taratura
dinamometria
a fine listino**

612 ÷ 614

cricchetti reversibili per barre dinamometriche



Gli articoli 612 e 612X non devono essere utilizzati con coppie di serraggio superiori a 100 Nm

	1/2	L mm	LA mm	€	1	006120000
612	3/8	66	32	71,00	2	006120000
612X	1/2	66	32	75,00	2	006120010
614	1/2	71	32	82,00	2	006140000
614X	3/4	71	32	89,50	2	006140004

614/50

cricchetto semplice
per barre dinamometriche



mm	mm	L mm	LA mm	€	
614/50	1/2	71	32	75,00	2 006140002

**Meccanismi rotanti
di ricambio dei cricchetti,
vedi tabella dopo l'art. 929/C8**

615

cricchetti reversibili
per barre dinamometriche
con attacco rettangolare



mm	mm	L mm	LA mm	€	
9x12	3/8	53	28,8	60,00	1 006150010
9x12	1/2	53	28,8	60,00	1 006150020
14x18	1/2	70	39,8	60,00	1 006150120

616 - 617 - 619

quadri maschi
per barre dinamometriche



mm	mm	L mm	LA mm	€	
616	1/4	61	32	56,00	1 006160000
617	3/8	61	32	56,00	1 006170000
619	1/2	63	32	56,00	1 006190000

621

accessori portainseri
per barre dinamometriche
con attacco rettangolare
con magnete



mm	mm	L mm	LA mm	€	
621P 1/4	9x12	1/4	43 28,8	71,50	1 006210000
* 621P 5/16	14x18	5/16	52,5 32,5	109,50	1 006210110

*Attenzione! Ricalcolare il valore di coppia da impostare
come indicato nella tabella in fondo al listino

622

cricchetti reversibili
per barre dinamometriche
con attacco tondo Ø 22 mm



mm	mm	L mm	LA mm	€	
622 3/4	3/4	110	56	199,50	1 006220019
622 1"	1	110	56	242,50	1 006220024

641

chiavi a forchetta
per barre dinamometriche 604B/5 e 604B/10



mm	L mm	€	
4	37	85,00	1 006410003
5	37	85,00	1 006410004
5,5	37	85,00	1 006410005
6	37	85,00	1 006410006
7	37	85,00	1 006410007
8	42	85,00	1 006410008
9	42	85,00	1 006410009
10	42	85,00	1 006410010

642

chiavi a forchetta
per barre dinamometriche

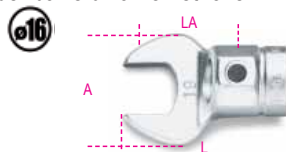

mm	L mm	LA mm	A mm	€	
8	54	32	22	60,50	1 006420008
10	57	32	26	60,50	1 006420010
12	58	32	30	60,50	1 006420012
13	58	32	30	60,50	1 006420013
14	59	32	32	60,50	1 006420014
15	59	32	35	60,50	1 006420015
16	59	32	38	60,50	1 006420016
17	60	32	39	60,50	1 006420017
18	61	32	42	60,50	1 006420018
19	61	32	43	60,50	1 006420019
20	61	32	50	94,00	1 006420020
21	62	32	53	94,00	1 006420021
22	62	32	53	103,00	1 006420022
23	65	32	53	103,00	1 006420023
24	63	32	53	103,00	1 006420024
25	64	32	53	126,00	1 006420125
26	64	32	59	126,00	1 006420026
27	65	32	59	126,00	1 006420027
28	66	32	64	126,00	1 006420028
30	66	32	66	126,00	1 006420030
32	67	32	66	126,00	1 006420032
* 36	76	42	80	172,50	1 006420036
* 40	77	52	95	172,50	1 006420040
* 41	78	52	95	172,50	1 006420041
* 46	90	52	95	208,00	1 006420046

*Attenzione! Ricalcolare il valore di coppia da impostare
come indicato nella tabella in fondo al listino

643

chiavi a forchetta
per barre dinamometriche
con attacco rettangolare



mm	mm	L mm	LA mm	€	
7	9X12	37	28,8	53,00	1 006430007
8	9x12	37	28,8	53,00	1 006430008
10	9x12	39	28,8	53,00	1 006430010
12	9x12	39	28,8	53,00	1 006430012
13	9x12	39	28,8	53,00	1 006430013
14	9x12	43	28,8	53,50	1 006430014
15	9x12	43	28,8	53,50	1 006430015
16	9x12	43	28,8	53,50	1 006430016
17	9x12	43	28,8	53,50	1 006430017
* 18	9x12	47	36,3	53,50	1 006430018
* 19	9x12	51	36,3	53,50	1 006430019
* 21	9X12	52	36,3	83,00	1 006430021
* 22	9x12	52	36,3	83,00	1 006430022

*Attenzione! Ricalcolare il valore di coppia da impostare
come indicato nella tabella in fondo al listino

mm	mm	L mm	LA mm	€	
13	14x18	60	39,8	55,50	1 006430113
14	14x18	58	39,8	55,50	1 006430114
15	14x18	60	39,8	55,50	1 006430115
16	14x18	60	39,8	56,00	1 006430116
17	14x18	60	39,8	56,00	1 006430117
18	14x18	61	39,8	56,00	1 006430118
19	14x18	61	39,8	56,00	1 006430119
21	14x18	61	39,8	87,50	1 006430121
22	14x18	62	39,8	87,50	1 006430122
24	14x18	64	39,8	87,50	1 006430124
* 27	14x18	68	44,8	99,00	1 006430127
* 30	14x18	77	49,8	99,50	1 006430130
* 32	14x18	77	49,8	99,50	1 006430132
* 34	14x18	80	54,8	158,00	1 006430134
* 36	14x18	83	54,8	158,00	1 006430136
* 38	14x18	83	54,8	158,00	1 006430138
* 41	14x18	91	64,8	158,00	1 006430141

*Attenzione! Ricalcolare il valore di coppia da impostare
come indicato nella tabella in fondo al listino

644

chiavi a forchetta
per barre dinamometriche
con attacco tondo Ø 22 mm



mm	L mm	LA mm	A mm	€	
22	91	56	52	103,00	1 006440022
24	91	56	52	103,00	1 006440024
27	94	56	64	126,00	1 006440027
30	94	56	64	126,00	1 006440030
32	97	56	75,5	126,00	1 006440032
34	97	56	75,5	126,00	1 006440034
36	97	56	75,5	172,50	1 006440036
41	103,5	56	94	172,50	1 006440041
46	115,5	56	94	208,00	1 006440046

650A

chiavi a rullino per barre dinamometriche con attacco rettangolare



A min-max mm	mm	L mm	LA mm	€		
* 5-27	9x12	93	74,3	97,00	1	006500027
* 5-30	9x12	106	85,3	97,00	1	006500030
* 5-30	14x18	115	89	99,00	1	006500130
* 10-41	14x18	127	100	102,00	1	006500141

*Attenzione! Ricalcolare il valore di coppia da impostare come indicato nella tabella in fondo al listino

650H

chiavi a settore per barre dinamometriche con attacco rettangolare



mm	mm	L mm	LA mm	€		
* 28-36	14x18	122	92	51,50	1	006500928
* 40-45	14x18	129	92	51,50	1	006500940
* 50-55	14x18	129	92	51,50	1	006500950
* 58-62	14x18	135	92	54,50	1	006500958
* 68-75	14x18	139	92	59,50	1	006500968
* 80-90	14x18	145	92	59,50	1	006500980

*Attenzione! Ricalcolare il valore di coppia da impostare come indicato nella tabella in fondo al listino

652

chiavi poligonali per barre dinamometriche



mm	L mm	LA mm	€		
8	58	32	65,50	1	006520008
10	58	32	65,50	1	006520010
12	58	32	65,50	1	006520012
13	58	32	65,50	1	006520013
14	58	32	65,50	1	006520014
15	62	32	65,50	1	006520015
16	63	32	65,50	1	006520016
17	64	32	65,50	1	006520017
18	65	32	65,50	1	006520018
19	65	32	65,50	1	006520019
21	67	32	98,50	1	006520021
22	68	32	104,00	1	006520022
24	69	32	124,50	1	006520024
26	71	32	140,00	1	006520026
27	71	32	140,00	1	006520027
30	73	32	140,00	1	006520030
32	74	32	140,00	1	006520032

653

chiavi poligonali per barre dinamometriche con attacco rettangolare



mm	mm	L mm	LA mm	€		
7	9x12	40	28,8	56,50	1	006530007
8	9x12	40	28,8	56,50	1	006530008
10	9x12	43	28,8	56,50	1	006530010
12	9x12	44	28,8	56,50	1	006530012
13	9x12	44	28,8	56,50	1	006530013
14	9x12	45	28,8	56,50	1	006530014
15	9x12	46	28,8	56,50	1	006530015
16	9x12	47	28,8	57,00	1	006530016
17	9x12	47	28,8	57,00	1	006530017
18	9x12	48	28,8	57,00	1	006530018
19	9x12	49	28,8	57,00	1	006530019
21	9x12	51	28,8	59,50	1	006530021
22	9x12	51	28,8	59,50	1	006530022

mm	mm	L mm	LA mm	€		
13	14x18	61	39,8	62,50	1	006530113
14	14x18	61	39,8	62,50	1	006530114
15	14x18	62	39,8	62,50	1	006530115
16	14x18	63	39,8	63,00	1	006530116
17	14x18	64	39,8	63,00	1	006530117
18	14x18	64	39,8	63,00	1	006530118
19	14x18	66	39,8	63,00	1	006530119
21	14x18	66	39,8	91,00	1	006530121
22	14x18	67	39,8	91,00	1	006530122
24	14x18	69	39,8	113,50	1	006530124
* 27	14x18	76	44,8	113,50	1	006530127
* 30	14x18	77	44,8	113,50	1	006530130
* 32	14x18	79	44,8	113,50	1	006530132
* 34	14x18	80	44,8	161,00	1	006530134
* 36	14x18	80	44,8	161,00	1	006530136
* 38	14x18	90	49,8	164,50	1	006530138
* 41	14x18	90	49,8	164,50	1	006530141

*Attenzione! Ricalcolare il valore di coppia da impostare come indicato nella tabella in fondo al listino

654

chiavi poligonali per barre dinamometriche con attacco tondo Ø 22 mm



mm	L mm	LA mm	A mm	€		
22	98,5	56	38	104,00	1	006540022
24	98,5	56	38	124,50	1	006540024
27	102,8	56	46,5	140,00	1	006540027
30	102,8	56	46,5	140,00	1	006540030
32	106,5	56	55	140,00	1	006540032
34	106,5	56	55	140,00	1	006540034
36	106,5	56	55	182,00	1	006540036
41	115,5	56	72	182,00	1	006540041
46	115,5	56	72	197,50	1	006540046

659/15

raccordo con attacco rettangolare femmina 14x18 mm e maschio 9x12 mm



mm	mm	mm	LA mm	€		
* 56	14x18	9x12	39	82,50	1	006590815

*Attenzione! Ricalcolare il valore di coppia da impostare come indicato nella tabella in fondo al listino



E' assolutamente necessario commisurare la coppia di serraggio alla capacità del quadro maschio per evitare rotture o danni accidentali

659/16

raccordo con attacco rettangolare femmina 9x12 mm e maschio 14x18 mm



mm	mm	mm	LA mm	€		
* 52	9x12	14x18	31	70,00	1	006590816

*Attenzione! Ricalcolare il valore di coppia da impostare come indicato nella tabella in fondo al listino

665

chiave dinamometrica meccanica a lettura digitale con cricchetto reversibile, per serraggi destrorsi, precisione di serraggio ± 3%

- Impostazione e lettura semplice della coppia tramite valore visualizzato sul display
- Il display rimane acceso con valore di coppia impostato
- Lettura della coppia con cifra decimale
- Spegnimento automatico dopo 10 sec. con impostazione della coppia inferiore alla soglia minima
- Alimentazione con 1 batteria da 3 V (inclusa)



UNI EN ISO 6789



Nm	mm	D mm	A mm	L mm	g	
10=60	3/8	30	33	335	655	0,1

€		
250,00	1	006650006

Nm	mm	D mm	A mm	L mm	g	
20=100	3/8	30	33	375	725	0,1

€		
252,00	1	006650010

Nm	mm	D mm	A mm	L mm	g	
20=100	1/2	30	37	375	725	0,1

€		
257,00	1	006650011

Nm	mm	D mm	A mm	L mm	g	
40=200	1/2	40	43	470	995	0,5

€		
274,00	1	006650020

Nm	mm	D mm	A mm	L mm	g	
60=330	1/2	40	43	590	1260	0,5

€		
311,00	1	006650030

665LB

chiave dinamometrica meccanica a lettura digitale con cricchetto reversibile, per serraggi destrorsi, precisione di serraggio $\pm 3\%$

- Unità di misura: lbf.ft
- Impostazione e lettura semplice della coppia tramite valore visualizzato sul display
- Il display rimane acceso con valore di coppia impostato
- Lettura della coppia con cifra decimale
- Spegnimento automatico dopo 10 sec. con impostazione della coppia inferiore alla soglia minima
- Alimentazione con 1 batteria da 3 V (inclusa)



UNI EN ISO 6789

lbf.ft	■	D mm	A mm	L mm	g	Ⓜ
7÷45	3/8	30	33	335	655	0,1

665LB/6 € 250,00 1 006650106

lbf.ft	■	D mm	A mm	L mm	g	Ⓜ
15÷75	3/8	30	33	375	725	0,1

665LB/10 € 252,00 1 006650110

lbf.ft	■	D mm	A mm	L mm	g	Ⓜ
15÷75	1/2	30	37	375	725	0,1

665LB/10X € 257,00 1 006650111

lbf.ft	■	D mm	A mm	L mm	g	Ⓜ
30÷150	1/2	40	43	470	995	0,5

665LB/20 € 274,00 1 006650120

lbf.ft	■	D mm	A mm	L mm	g	Ⓜ
45÷240	1/2	40	43	590	1260	0,5

665LB/30 € 311,00 1 006650130

665SW

dispositivo di calibrazione

- Il dispositivo permette la calibrazione delle chiavi serie 665 con l'ausilio dei misuratori di coppia Beta 680 e 682, senza la necessità di smontare la chiave.
- La calibrazione avviene su più punti per compensare il comportamento non lineare della molla.
- Dotato di presa Micro USB per consentire futuri aggiornamenti firmware.



665SW € 25,00 1 006650100

666-667 ZERO-RESET

LE NUOVE CHIAVI CHE NON DEVONO ESSERE SCARICATE A FINE UTILIZZO

Anche se la chiave non viene scaricata, vengono ugualmente garantiti il numero di cicli, la durata nel tempo e la precisione di serraggio richiesta dalla normativa di riferimento.

Per confermare questi parametri il dipartimento di Ricerca & Sviluppo di Beta Utensili ha condotto numerosi e prolungati test di durata nei laboratori interni e presso centinaia di utilizzatori finali.

Questo risultato è stato ottenuto attraverso:

- Utilizzo dei materiali più performanti attualmente disponibili
- Trattamenti termici speciali sulla componentistica interna

100% MADE IN ITALY

La chiave dinamometrica Zero-Reset è stata interamente progettata e sviluppata internamente ed è prodotta presso gli stabilimenti di Beta Utensili in Italia utilizzando componentistica 100% Made in Italy.

Le nuove componentistiche della chiave consentono di non dover più riportare al minimo la chiave a fine del ciclo di utilizzo.



666

chiavi dinamometriche a scatto **ZERO-RESET** con cricchetto reversibile per serraggi destrorsi per serraggi destrorsi precisione di serraggio $\pm 3\%$

• Non necessita di essere scaricata



UNI EN ISO 6789

Nm	█	D mm	A mm	L mm	g	🔋
5÷25	1/4	26	25	273	395	0,05

666/2 275,00 1 006660702

Nm	█	D mm	A mm	L mm	g	🔋
5÷25	3/8	26	29	273	405	0,05

666/2X 275,00 1 006660703

Nm	█	D mm	A mm	L mm	g	🔋
10÷50	3/8	30	33	342	680	0,25

666/5 250,00 1 006660705

Nm	█	D mm	A mm	L mm	g	🔋
20÷100	3/8	30	33	385	760	0,25

666/10 252,00 1 006660710

Nm	█	D mm	A mm	L mm	g	🔋
20÷100	1/2	30	37	385	770	0,25

666/10X 257,00 1 006660711

Nm	█	D mm	A mm	L mm	g	🔋
40÷200	1/2	42	43	471	1020	0,5

666/20 274,00 1 006660720

Nm	█	D mm	A mm	L mm	g	🔋
60÷300	1/2	42	43	600	1270	1,0

666/30 311,00 1 006660730

666 LBF.FT

chiavi dinamometriche a scatto **ZERO-RESET** con cricchetto reversibile per serraggi destrorsi per serraggi destrorsi precisione di serraggio $\pm 3\%$

• Non necessita di essere scaricata
• Scala in libbre-forza piedi



UNI EN ISO 6789

lbf.ft	█	D mm	A mm	L mm	g	🔋
4÷18	1/4	26	25	273	395	0,05

666 LBF.FT/2 260,00 1 006660762

lbf.ft	█	D mm	A mm	L mm	g	🔋
4÷18	3/8	26	29	273	405	0,05

666 LBF.FT/2X 260,00 1 006660763

lbf.ft	█	D mm	A mm	L mm	g	🔋
7÷37	3/8	30	33	342	680	0,25

666 LBF.FT/5 236,00 1 006660765

lbf.ft	█	D mm	A mm	L mm	g	🔋
15÷75	3/8	30	33	385	760	0,25

666 LBF.FT/10 238,00 1 006660780

lbf.ft	█	D mm	A mm	L mm	g	🔋
15÷75	1/2	30	37	385	770	0,25

666 LBF.FT/10X 243,00 1 006660781

lbf.ft	█	D mm	A mm	L mm	g	🔋
30÷150	1/2	42	43	471	1020	0,5

666 LBF.FT/20 259,00 1 006660782

lbf.ft	█	D mm	A mm	L mm	g	🔋
50÷230	1/2	42	43	600	1270	1,0

666 LBF.FT/30 294,00 1 006660783

667

chiavi dinamometriche a scatto **ZERO-RESET** con cricchetto semplice per serraggi destrorsi e sinistrorsi precisione di serraggio $\pm 3\%$

• Non necessita di essere scaricata



UNI EN ISO 6789

Nm	█	D mm	A mm	L mm	g	🔋
40÷200	1/2	42	42	471	1035	0,5

667/20 269,00 1 006670720

Nm	█	D mm	A mm	L mm	g	🔋
60÷300	1/2	42	42	600	1285	1,0

667/30 300,00 1 006670730

Nm	█	D mm	A mm	L mm	g	🔋
80÷400	3/4	59	53	710	2220	1,0

667/40 721,00 1 006670740

Meccanismi rotanti di ricambio dei cricchetti, vedi tabella dopo l'art. 929/C8

668N

barre dinamometriche a scatto per serraggi destrorsi e sinistrorsi precisione di serraggio $\pm 3\%$



UNI EN ISO 6789

Nm	Kgfm	lbf.ft	Ø mm	L mm	LB mm	LS mm	g	🔋
5÷25	0,5÷2,5	4÷18	16	220	148	32	300	0,2

668N/2 252,00 1 006680002

Nm	Kgfm	lbf.ft	Ø mm	L mm	LB mm	LS mm	g	🔋
10÷50	1÷5	7÷37	16	332	229	32	590	0,5

668N/5 246,50 1 006680005

Nm	Kgfm	lbf.ft	Ø mm	L mm	LB mm	LS mm	g	🔋
20÷100	2÷10	15÷75	16	362	269	32	670	1,0

668N/10 252,00 1 006680010

Nm	Kgfm	lbf.ft	Ø mm	L mm	LB mm	LS mm	g	🔋
40÷200	4÷20	30÷150	16	445	352,6	32	795	2,0

668N/20 274,00 1 006680020

Nm	Kgfm	lbf.ft	Ø mm	L mm	LB mm	LS mm	g	🔋
60÷300	6÷30	50÷220	16	569	475,9	32	1230	2,0

668N/30 311,00 1 006680030



668RG

barra dinamometrica a scatto
non graduata
adatta a serraggi destrorsi e sinistrorsi
precisione di serraggio $\pm 4\%$
(per il settaggio della coppia usare gli art. 680 - 682)



UNI EN ISO 6789

Nm	Kgfm	lbf.ft	Ø mm	L mm	g
8÷60	0,8÷6	6÷44	16	288	550

668RG/6 € 203,00 1 006680206

Nm	Kgfm	lbf.ft	Ø mm	L mm	g
20÷100	2÷10	15÷80	16	315	600

668RG/10 € 209,00 1 006680210

Nm	Kgfm	lbf.ft	Ø mm	L mm	g
40÷200	4÷20	30÷150	16	405	780

668RG/20 € 222,50 1 006680220

Nm	Kgfm	lbf.ft	Ø mm	L mm	g
60÷300	6÷30	50÷220	16	645	1130

668RG/30 € 248,00 1 006680230

668RGC

chiave dinamometrica a scatto
non graduata
con cricchetto reversibile
adatta a serraggi destrorsi
precisione di serraggio $\pm 4\%$
(per il settaggio della coppia usare gli art. 680 - 682)



UNI EN ISO 6789

Nm	Kgfm	lbf.in	D mm	A mm	L mm	g
12÷60	1,2÷6	5÷45	3/8	30	33	600

668RGC/6 € 185,00 1 006680406

Nm	Kgfm	lbf.in	D mm	A mm	L mm	g
20÷100	2÷10	15÷75	3/8	30	33	700

668RGC/10 € 193,50 1 006680410

Nm	Kgfm	lbf.in	D mm	A mm	L mm	g
20÷100	2÷10	15÷75	1/2	40	43	700

668RGC/10X € 193,50 1 006680411

Nm	Kgfm	lbf.in	D mm	A mm	L mm	g
40÷200	4÷20	30÷150	1/2	40	43	1000

668RGC/20 € 197,50 1 006680420

669N

barre dinamometriche a scatto
attacco rettangolare femmina
per serraggi destrorsi e sinistrorsi
precisione di serraggio $\pm 3\%$



UNI EN ISO 6789

Nm	Kgfm	lbf.ft	□ mm	L mm	LB mm	LS mm	g
5÷25	0,5÷2,5	4÷18	9x12	215	140	28,8	300

669N/2 € 359,00 1 006690202

Nm	Kgfm	lbf.ft	□ mm	L mm	LB mm	LS mm	g
10÷50	1÷5	7÷37	9x12	322	226,8	28,8	590

669N/5 € 276,00 1 006690205

Nm	Kgfm	lbf.ft	□ mm	L mm	LB mm	LS mm	g
20÷100	2÷10	15÷75	9x12	362	266,8	28,8	670

669N/10 € 297,00 1 006690210

Nm	Kgfm	lbf.ft	□ mm	L mm	LB mm	LS mm	g
40÷200	4÷20	30÷150	9x12	445	345,6	28,8	795

669N/20 € 356,00 1 006690220

Nm	Kgfm	lbf.ft	□ mm	L mm	LB mm	LS mm	g
40÷200	4÷20	30÷150	14x18	452	351	39,8	795

669N/20X € 376,00 1 006690221

Nm	Kgfm	lbf.ft	□ mm	L mm	LB mm	LS mm	g
60÷300	6÷30	50÷220	14x18	569	468,5	39,8	1230

669N/30 € 397,00 1 006690230

Nm	Kgfm	lbf.ft	□ mm	L mm	LB mm	LS mm	g
80÷400	8÷40	60÷295	14x18	664	563	39,8	2100

669N/40 € 457,00 1 006690240



671B/C5

barra dinamometrica 604B/5 e accessori



671B/C5 € 1.004,00 1 006710001

604B/5	1÷5 Nm
611	1/4
641	5-6-7-8 mm
900	4-5-5,5-6-7-8-9-10 mm

270x120x45 mm - 1,3 kg

671B/C10

barra dinamometrica 604B/10 e accessori



671B/C10 € 1.004,00 1 006710002

604B/10	2÷10 Nm
611	1/4
641	6-7-8-10 mm
900	4-5-5,5-6-7-8-9-10 mm

270x120x45 mm - 1,4 kg

671N/C10

barra dinamometrica 668N/10 e accessori



671N/C10 € 1.134,00 1 006710110

668N/10	100 Nm
612	3/8
617	3/8
642	10-13-14-17-19 mm
652	10-13-14-17-19 mm
910A	3/8 8-10-11-13-14-17-19 mm
910/21	125 mm
910/22	250 mm

400x180x45 mm - 4,3 kg

671N/C20

barra dinamometrica 668N/20
e accessori



671N/C20 € 1.199,00 1 006710120

668N/20	200 Nm
614	■ 1/2
619	■ 1/2
642	10-13-14-17-19 mm
652	10-13-14-17-19 mm
920A	□ 1/2 10-11-13-14-17-19-22 mm
920/20	75 mm
920/21	125 mm
920/22	255 mm

510x180x45 mm - 5,5 kg

671N/C30

barra dinamometrica 668N/30
e accessori



671N/C30 € 1.139,00 1 006710130

668N/30	300 Nm
614	■ 1/2
619	■ 1/2
642	13-14-17-19 mm
652	13-14-17-19 mm
920A	□ 1/2 13-14-17-19-22-24-27 mm
920/20	75 mm
920/21	125 mm
920/22	255 mm

620x180x45 mm - 5,8 kg

Beta

674/C

barre dinamometriche a scatto
attacco tondo Ø 22 mm
per serraggi destrorsi e sinistrorsi
precisione di serraggio ± 4%
in cassetta



UNI EN ISO 6789

Nm	Kgfm	lbf.ft	Ø	L	LB	LS	kg	mm
100÷500	10÷50	80÷400	22	786	725	56	3,4	1,25

674/C50 € 832,00 1 006740005

Nm	Kgfm	lbf.ft	Ø	L	LB	LS	kg	mm
160÷800	16÷80	120÷600	22	997	915	56	4,5	2,0

674/C80 € 882,00 1 006740008

Nm	Kgfm	lbf.ft	Ø	L	LB	LS	kg	mm
200÷1000	20÷100	150÷750	22	997	915	56	4,5	2,5

674/C100 € 894,00 1 006740010

677

chiavi dinamometriche a disinnesto
con cricchetto semplice
per serraggi destrorsi e sinistrorsi
precisione di serraggio ± 4%



UNI EN ISO 6789

Nm	Kgfm	lbf.ft	D	A	L	kg	mm
120÷600	12÷60	100÷450	69	55	1059	6,0	10

677/600 € 932,00 1 006770006

Nm	Kgfm	lbf.ft	D	A	L	kg	mm
200÷800	20÷80	150÷600	69	55	1319	6,7	10

677/800 € 975,00 1 006770008

Nm	Kgfm	lbf.ft	D	A	L	kg	mm
300÷1000	30÷100	200÷750	69	55	1554	7,4	20

677/1000 € 1.045,00 1 006770010

677/C

chiavi dinamometriche a disinnesto
con cricchetto semplice
per serraggi destrorsi e sinistrorsi
precisione di serraggio ± 4%
in cassetta



UNI EN ISO 6789

Nm	Kgfm	lbf.ft	D	A	L	kg	mm
120÷600	12÷60	100÷450	69	55	1059	6,0	10

677/C600 € 1.101,00 1 006770607

Nm	Kgfm	lbf.ft	D	A	L	kg	mm
200÷800	20÷80	150÷600	69	55	1319	6,7	10

677/C800 € 1.144,00 1 006770612

Nm	Kgfm	lbf.ft	D	A	L	kg	mm
300÷1000	30÷100	200÷750	69	55	1554	7,4	20

677/C1000 € 1.215,00 1 006770616

Nm	Kgfm	lbf.ft	D	A	L	kg	mm
700÷1500	70÷150	500÷1000	69	55	1869	9,6	25

677/C1500 € 1.555,00 1 006770621

677/CP2000

chiavi dinamometriche a disinnesto
con cricchetto semplice
per serraggi destrorsi e sinistrorsi
precisione di serraggio ± 4%
in cassetta



UNI EN ISO 6789

Nm	Kgfm	lbf.ft	D	A	L	kg	mm
900÷2000	90÷200	700÷1500	69	63	1940	12,75	50

677/CP2000 € 2.850,00 1 006770721

Beta

Beta

Quality Tools

Beta

678/C

chiavi dinamometriche a scatto con cricchetto semplice per serraggi destrorsi e sinistrorsi
precisione di serraggio $\pm 4\%$ in cassetta

• Modelli 678/C100 e 678/C150 forniti di prolunga.

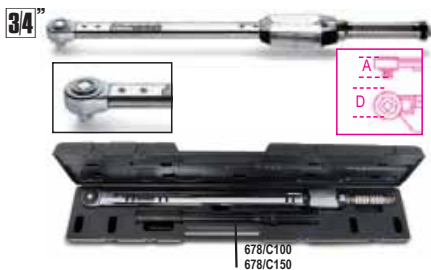

UNI EN ISO 6789

Nm	Kgfm	lbf.ft	D	A	L	kg
130÷650	13÷65	100÷480	63	55	885	3,9

678/C65	€ 1.720,00	1	006780607
---------	------------	---	-----------

Nm	Kgfm	lbf.ft	D	A	L	kg
300÷1000	30÷100	220÷750	75	60	1250	6,0

678/C100	€ 2.280,00	1	006780611
----------	------------	---	-----------

Nm	Kgfm	lbf.ft	D	A	L	kg
500÷1500	50÷150	370÷1100	75	60	1570	8,5

678/C150	€ 2.485,00	1	006780615
----------	------------	---	-----------

677/CV - 678/CV

cassette vuote per chiavi dinamometriche 677 e 678



677/CVN1	€ 169,50	1	006770455
677/C600-677/C800-677/C1000			
677/CVN2	€ 222,50	1	006770460
677/C1500-677/CP2000			
678/CV1	€ 160,00	1	006780455
678/C65			
678/CV2	€ 180,00	1	006780500
678/C100			
678/CV3	€ 297,00	1	006780415
677/C100-677/C150-678/C150			

680

misuratore di coppia elettronico digitale Dynatester 680 per verifica tarature
funzionamento destrorso e sinistrorso

- Precisione di lettura: $\pm 1\%$ del valore letto
- Display LCD a colori, 4 digit
- Fino a 12 unità di misura (Nm - lbf.ft. - lbf.in...)



	Nm	kg	€		
680/3	0,1÷3	1,4	2.920,00	1	006800000
680/30	1,5÷30	1,4	2.880,00	1	006800003
680/350	10÷350	2,6	2.890,00	1	006800035
680/2100	200÷2100	3,5	4.300,00	1	006800210

682

misuratore di coppia elettronico digitale con trasduttori porziometrici Dynatester 682
funzionamento destrorso e sinistrorso

Alta precisione di lettura
Fornito di uscita seriale RS 232



CARATTERISTICHE TECNICHE:
Precisione di lettura: $\pm 1\%$ del valore letto
Unità di misura selezionabili
Nm-dNm-cNm-Lbf.ft-Lbf.in-Ozf.in-Kgf.m-Kgf.cm-gf.cm
Alimentazione: 90 a 264V AC a 50/60 Hz
Dimensioni: 235x185x185 mm

Verifica di tolleranza secondo norma ISO6789
Indicazione dell'intervallo di accettabilità specifico per ogni chiave dinamometrica testata
Display: Menu selezionabile in 11 lingue
Documentazione allegata
Certificato di calibrazione con rintracciabilità UKAS

	Nm	kg	€		
682/60	1,2÷60	5,9	5.970,00	1	006820006
682/400	8÷400	6,1	6.060,00	1	006820040
682/1500	30÷1500	6,4	6.250,00	1	006820150

BUSSOLE MACCHINA



Le chiavi a bussola macchina sono realizzate con acciai e trattamenti termici tali da garantire la migliore resistenza all'impatto e alle vibrazioni.

Il nuovo **profilo poligonale** permette di ottenere un immediato accoppiamento sul dado. Nel loro impiego è assolutamente necessario l'uso di spine e anelli di tenuta per impedire il distacco dal quadro di manovra.

Ai classici modelli standard, serie lunga e lunga sottile si affiancano il **nuovo profilo XZN®** e un ampliamento di gamma degli accessori per bussole macchina.

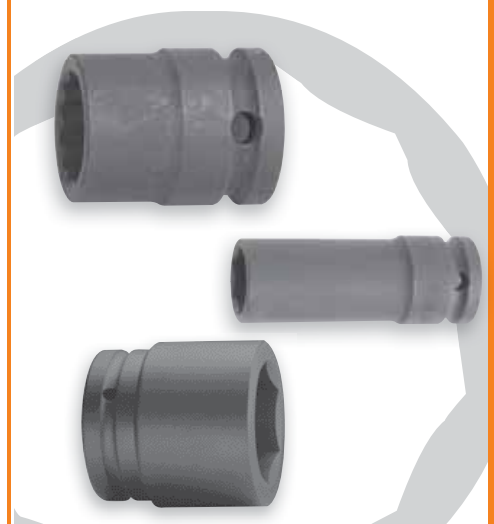

710

chiavi a bussola Macchina serie normale



UNI/ISO 2725 DIN 3129

mm	Ø mm	L mm	Ø1 mm	€		
7	12,5	28	19	8,75	3	007100007
8	13,8	28	19	8,75	3	007100008
9	15,0	28	19	8,75	3	007100009
10	16,3	28	19	8,75	3	007100010
11	17,5	30	19	8,75	3	007100011
12	19,0	30	19	8,75	3	007100012
13	20,0	30	22	9,20	3	007100013
14	21,3	30	22	9,20	3	007100014
16	23,8	30	22	9,35	3	007100016
17	25,0	30	22	9,35	3	007100017
18	26,3	30	22	9,60	3	007100018
19	27,5	30	22	9,60	3	007100019
21	30,0	32	22	10,60	3	007100021
22	32,0	32	22	11,80	3	007100022

710/C10

10 chiavi a bussola Macchina



710/C10
7-8-10-11-12-13
14-17-19-22 mm

130x55x40 mm - 800 g

710/16

raccordo Macchina con attacco quadro femmina 3/8" e maschio 1/2"



L mm Ø mm □ mm ■ mm €

32	22	3/8	1/2	23,70	3	007100810
----	----	-----	-----	-------	---	-----------

710/20

prolunga Macchina con attacchi quadri maschio e femmina 3/8"



L mm Ø mm €

75	22			24,20	2	007100821
----	----	--	--	-------	---	-----------

710/21

prolunga Macchina con attacchi quadri maschio e femmina 3/8"



L mm Ø mm €

125	22			26,50	2	007100823
-----	----	--	--	-------	---	-----------

710/22

prolunga Macchina con attacchi quadri maschio e femmina 3/8"



L mm Ø mm €

150	22			31,00	2	007100825
-----	----	--	--	-------	---	-----------

710/25

snodo Macchina con attacchi quadri maschio e femmina 3/8"



L mm Ø mm €

58	24			49,00	2	007100830
----	----	--	--	-------	---	-----------

710/OR... - 710/SP...

anelli e spine per bussole e accessori Macchina



	710 mm	710/16 L mm	€		
710/OR1	7-12		0,73	10	007100921
710/OR2	13-22	32	0,73	10	007100922
710/SP1	7-12		1,34	10	007100911
710/SP2	13-22	32	1,34	10	007100912

720

chiavi a bussola Macchina serie normale



UNI/ISO 2725 DIN 3129

mm	Ø mm	L mm	Ø1 mm	€		
8	15,0	38	25	10,50	5	007200008
9	16,0	38	25	10,50	5	007200009
10	17,0	38	25	10,70	5	007200010
11	18,5	38	25	10,70	5	007200011
12	20,0	38	25	10,70	5	007200012
13	21,0	38	25	10,70	5	007200013
14	22,5	38	25	10,70	5	007200014
15	23,0	38	30	12,00	5	007200015
16	25,0	38	30	12,00	5	007200016
17	26,0	38	30	12,00	5	007200017
18	27,5	38	30	12,00	5	007200018
19	28,5	38	30	12,00	5	007200019
20	30	38	30	13,20	5	007200020
21	31,0	38	30	13,20	5	007200021
22	32,5	38	30	13,40	5	007200022
23	34,0	38	30	14,60	5	007200023
24	35,0	38	30	14,60	5	007200024
27	38,5	45	30	17,00	3	007200027
29	41	47	30	18,60	3	007200029
30	42,0	50	30	18,60	3	007200030
32	44,0	50	30	21,30	3	007200032
36	50,0	50	30	30,50	3	007200036

720/C6

6 chiavi a bussola Macchina



720/C6
13-14-17-19-22-24 mm

195x80x55 mm - 1100 g

720/C12

12 chiavi a bussola Macchina



720/C12
10-11-12-13-14-17
19-22-24-27-30-32 mm



195x80x55 mm - 2000 g

720/C24

24 chiavi a bussola Macchina



720/C24 € 422,00 1 007200904

-  720 10 - 12 - 13 - 14 - 15 - 16 - 17 - 18 - 19 - 21 - 22 - 24 - 27 - 30 - 32 mm
-  720L 13 - 17 - 19 - 21 - 22 - 24 mm
-  720LC 17 - 19 - 21 mm

≡ 420x185x60 mm - 6,2 kg

720MC

chiavi a bussola Macchina serie normale colorate



mm	Ø mm	L mm	€		
10	17,0	38	11,10	3	007202010
11	18,5	38	11,10	3	007202011
12	20,0	38	11,10	3	007202012
13	21,0	38	11,10	3	007202013
14	22,5	38	11,10	3	007202014
15	23,0	38	12,50	3	007202015
16	25,0	38	12,50	3	007202016
17	26,0	38	12,50	3	007202017
18	27,5	38	12,50	3	007202018
19	28,5	38	12,50	3	007202019
21	31,0	38	13,90	2	007202021
22	32,5	38	13,90	2	007202022
24	35,0	38	15,20	2	007202024

720MC/C13

13 chiavi a bussola Macchina colorate



720MC/C13 € 201,00 1 007202913

10-11-12-13-14-15
16-17-18-19-21-22
24 mm

≡ 335x145x60 mm - 2,4 kg

720B

chiavi a bussola Macchina bocca poligonale



UNI/ISO 2725 DIN 3129

mm	Ø mm	L mm	Ø1 mm	€		
10	17	38	25	10,70	5	007201010
11	18	38	25	10,70	5	007201011
12	19	38	25	10,70	5	007201012
13	20	38	25	10,70	5	007201013
14	22	38	25	10,70	5	007201014
15	23	38	30	12,00	5	007201015
16	24	38	30	12,00	5	007201016
17	26	38	30	12,00	5	007201017
18	27	38	30	12,00	5	007201018
19	28	38	30	12,00	5	007201019
21	30	38	30	13,20	5	007201021
22	31,8	38	30	13,40	5	007201022
23	31,8	38	30	14,60	5	007201023
24	33,8	40	30	14,60	5	007201024
27	37,8	43	30	17,00	3	007201027
30	41,8	43	30	18,60	3	007201030
32	43,8	43	30	21,30	3	007201032
36	49,8	50	30	30,50	3	007201036

720B/C12

12 chiavi a bussola Macchina bocca poligonale



UNI/ISO 2725 DIN 3129

720B/C12 € 197,50 1 007201912

10-11-12-13-14-17
19-22-24-27-30-32 mm

≡ 195x80x55 mm - 2000 g

720AS

chiavi a bussola Macchina serie normale



mm	Ø mm	L mm	Ø1 mm	€		
3/8	17,0	38	25	17,30	2	007200210
7/16	18,2	38	25	17,30	2	007200211
1/2	20,7	38	25	17,30	2	007200213
9/16	22,0	38	25	17,30	2	007200214
5/8	24,5	38	30	18,60	2	007200216
11/16	25,7	38	30	18,60	2	007200217
3/4	28,2	38	30	18,60	2	007200219
13/16	30,7	38	30	19,70	2	007200221
7/8	32,0	38	30	19,70	2	007200222
15/16	34,5	38	30	21,00	2	007200224

mm	Ø mm	L mm	Ø1 mm	€		
1	35,7	38	30	22,60	2	007200225
1.1/16	38,2	40	30	25,00	1	007200227
1.1/8	40,7	42	30	28,00	1	007200229
1.1/4	44,5	42	30	31,00	1	007200232

720S

chiavi a bussola Macchina serie compatta



mm	Ø mm	L mm	Ø1 mm	€		
13	20,0	28,0	23,8	6,70	3	007200113
15	23,0	28,0	23,8	6,70	3	007200115
17	25,8	28,0	25,8	7,30	3	007200117
19	27,8	28,0	27,8	7,95	3	007200119
22	31,8	28,0	30,0	8,65	3	007200122
24	33,8	28,0	30,0	9,45	3	007200124



720S/SB6 € 57,50 1 007200906
13-15-17-19-22-24 mm

720L

chiavi a bussola Macchina serie lunga



UNI/ISO 2725

mm	Ø mm	L mm	Ø1 mm	€		
10	17,0	80	25	18,30	2	007200310
11	18,5	80	25	18,30	2	007200311
12	20,0	80	25	18,30	2	007200312
13	21,0	80	25	18,30	2	007200313
14	22,5	80	25	18,30	2	007200314
15	23,0	80	30	20,80	2	007200315
16	25,0	80	30	20,80	2	007200316
17	26,0	80	30	20,80	2	007200317
18	27,5	80	30	22,00	2	007200318
19	28,5	80	30	22,00	2	007200319
21	31,0	80	30	23,30	2	007200321
22	32,5	80	30	23,30	2	007200322
24	35,0	80	30	24,40	2	007200324
27	38,5	80	30	30,50	2	007200327
30	42,0	80	30	37,00	2	007200330
32	44,0	80	30	37,00	2	007200332
36	50,0	80	30	47,50	2	007200336

720L/S3

serie di 3 chiavi a bussola 720L



720L/S3 € 66,00 1 007200355
17-19-21 mm

720LS

chiavi a bussola Macchina serie lunga sottile



mm	Ø mm	L mm	Ø1 mm	€	Icon	Icon
10	15,5	78	24	19,70	2	007200360
11	16,7	78	24	19,70	2	007200361
12	18,0	78	24	19,70	2	007200362
13	19,2	78	24	19,70	2	007200363
14	20,5	78	24	19,70	2	007200364
15	21,7	78	24	20,30	2	007200365
16	23,0	78	24	20,30	2	007200366
17	24,2	78	29	22,60	2	007200367
18	25,5	78	29	24,40	2	007200368
19	26,7	78	29	24,40	2	007200369
21	29,2	78	29	25,50	2	007200371
22	30,5	78	29	25,50	2	007200372
24	33,0	78	29	26,00	2	007200374
27	36,7	78	29	32,00	2	007200377
30	40,5	78	29	40,50	2	007200380
32	43,0	78	29	42,00	2	007200382
36	48,0	78	29	63,00	2	007200386

720LC

chiavi a bussola Macchina per dadi ruote con inserti polimerici colorati



mm	Ø mm	Color	€	Icon	Icon
17	26,5	Blue	13,20	2	007200637
19	28,5	Yellow	13,20	2	007200639
21	30,3	Red	13,70	2	007200641
22	32,4	Green	14,30	2	007200642
24	34,6	Purple	15,50	2	007200644



720LC/C3
17-19-21 mm
148x132x44 mm - 860 g



720LC/S5
17-19-21-22-24 mm

12"



720LC/PM5
17-19-21-22-24 mm
117,50 € 1 007200646

PM 1/2-Q5

guida magnetica portabussole



PM 1/2-Q5
47,50 € 1 088880233

720IC

inserti di ricambio polimerici colorati per chiavi a bussola 720LC-720LCL



mm	Color	€	Icon	Icon
720IC 17	Blue	5,30	1	007200687
720IC 19	Yellow	5,30	1	007200689
720IC 21	Red	5,30	1	007200691
720IC 22	Green	5,30	1	007200692
720IC 24	Purple	5,30	1	007200694



720LCL

chiavi a bussola Macchina per dadi ruote con inserti polimerici colorati serie lunga



mm	Ø mm	Color	€	Icon	Icon
17	26,5	Blue	21,80	1	007200737
19	28,5	Yellow	21,80	1	007200739
21	30,3	Red	21,80	1	007200741



720LCL/C3
17-19-21 mm
210x50x150 mm - 1,65 kg

720MRC

chiave a bussola Macchina con inserto polimerico per vite ruota con profilo Mercedes



720MRC
17 mm Ø 27 mm L 85 mm 1/2
21,40 € 1 007200631

720FRD

chiave a bussola per dadi ruota Ford con rivestimento in alluminio danneggiato

indispensabile quando le creste del dado risultano danneggiate dall'avvitatore ad impulsi



720FRD
18,5÷19,5 mm Ø L 63 mm
20,30 € 1 007200633

720RNG

chiave a bussola per dadi ruota Jeep Renegade con rivestimento in alluminio danneggiato

Indispensabile quando le creste del dado risultano danneggiate dall'avvitatore ad impulsi



720RNG
16,5÷17,5 mm Ø L 63 mm
20,30 € 1 007200634

720TC

barre di torsione Macchina colorate per dadi ruote autoveicoli con attacchi quadri maschio e femmina 1/2"



Nm	L mm	Color	€	Icon	Icon
90	200	Yellow	23,10	1	007200769
100	200	Green	23,10	1	007200770
110	200	Blue	23,10	1	007200771
120	200	Pink	23,10	1	007200772
135	200	Red	23,10	1	007200773

12"



720TC/S5

90-100-110-120-135 Nm

260x50x175 mm - 1,35 kg

€ 115,50



1 007200779

720FTX

chiavi a bussola Macchina per viti con testa a profilo Torx®

12"



	Ø mm	L mm	Ø1 mm	€		
E10	14,0	38	25	17,10	2	007200410
E12	15,9	38	25	17,10	2	007200412
E14	17,7	38	25	17,10	2	007200414
E16	20,0	38	25	17,10	2	007200416
E18	22,0	38	25	17,10	2	007200418
E20	25,0	40	25	18,20	2	007200420
E24	30,0	40	30	18,20	2	007200424

12"



720FTX/SB6

E10-E12-E14

E16-E18-E20

€ 114,50



1 007200450

720TX

chiavi a bussola maschio Macchina per viti con impronta Torx®

12"



	Ø mm	L mm	L1 mm	€		
T30	25	78	54	15,00	3	007200460
T40	25	78	54	15,00	3	007200470
T45	25	78	54	15,30	3	007200472
T50	25	78	54	15,30	3	007200474
T55	25	78	54	17,30	3	007200476
T60	25	78	54	18,60	3	007200478

720TX/C6

6 chiavi a bussola maschio Macchina per viti con impronta Torx®

12"



720TX/C6

T30-T40-T45

T50-T55-T60

€ 126,50



1 007200483

275x120x65 mm - 5700 g

720ME

chiavi a bussola Macchina maschio esagonale

12"



mm	Ø mm	L mm	L1 mm	€		
5	25	78	54	14,40	3	007200505
6	25	78	54	14,40	3	007200506
8	25	78	54	14,40	3	007200508
10	25	78	54	14,40	3	007200510
12	25	78	54	14,40	3	007200512
14	25	78	54	16,10	3	007200514
17	25	78	54	16,10	3	007200517
19	25	78	54	16,10	3	007200519

720ME/C8

8 chiavi a bussola Macchina maschio esagonale

12"



720ME/C8

5-6-8-10-12

14-17-19 mm

€ 155,00



1 007200525

270x120x45 mm - 1710 g

9899 720ME/C8

termoformato vuoto

€ 13,90



1 098990130

720XZN

chiavi a bussola maschio Macchina per viti con impronta XZN®

12"



mm	Ø mm	L mm	L1 mm	€		
M4	25	77	53	16,30	3	007201504
M5	25	77	53	16,30	3	007201505
M6	25	77	53	16,30	3	007201506
M8	25	77	53	16,30	3	007201508
M10	25	77	53	16,70	3	007201510
M12	25	77	53	17,10	3	007201512
M14	25	77	53	17,10	3	007201514
M16	25	77	53	17,50	3	007201516
M18	25	77	53	18,40	3	007201518

720XZN/C6

6 chiavi a bussola Macchina per viti con impronta XZN®

12"



720XZN/C6

M8-M10-M12-M14

M16-M18

€ 133,00



1 007201530

275x120x65 mm - 5700 g

720/SN

chiavi a bussola Macchina serie snodata

12"



mm	Ø mm	L mm	Ø1 mm	€		
17	25,7	69,6	30	75,00	2	007200087
19	28,2	73,6	30	75,00	2	007200089
24	34,5	75,6	30	84,00	2	007200094

720/15

raccordo Macchina con attacco quadro femmina 1/2" e maschio 3/8"

12"



L mm	Ø mm	□	■	€		
37,5	25	1/2	3/8	12,00	3	007200810



E' assolutamente necessario commisurare la coppia di serraggio alla capacità del quadro maschio per evitare rotture o danni accidentali

720/16

raccordo Macchina con attacco quadro femmina 1/2" e maschio 3/4"

12"



L mm	Ø mm	□	■	€		
44	30	1/2	3/4	20,70	3	007200814

720/20

prolunga Macchina con attacchi quadri maschio e femmina 1/2"



L mm	Ø mm	€	Icon	Code
75	25	21,30	3	007200818

720/21

prolunga Macchina con attacchi quadri maschio e femmina 1/2"



L mm	Ø mm	€	Icon	Code
125	25	23,10	3	007200822

720/22

prolunga Macchina con attacchi quadri maschio e femmina 1/2"



L mm	Ø mm	€	Icon	Code
250	25	27,00	3	007200824

720/25

snodo Macchina con attacchi quadri maschio e femmina 1/2"



L mm	Ø mm	€	Icon	Code
64	28	39,50	2	007200831

720/OR... - 720/SP...

anelli e spine per bussole e accessori Macchina



720/Ø mm	720TX T30+T60	€	Icon	Code
720/OR1 10+14	T30+T60	1,37	10	007200923
720/OR2 15+36	T30+T60	1,37	10	007200924
720/SP1 10+14	T30+T60	2,02	10	007200913
720/SP2 15+36	T30+T60	2,02	10	007200914

727PI/16 1/2

bussola portainseri Macchina per 727/ES16 e 727/ES16TX



Ø mm	L mm	Ø mm	1/2	€	Icon	Code
28	42	16	1/2	35,50	2	007270015

727PI/16

bussola portainseri Macchina per 727/ES16 e 727/ES16TX



Ø mm	L mm	Ø mm	3/4	€	Icon	Code
44	52	16	3/4	46,50	2	007270016

727/ES16

inserti Macchina maschio esagonale attacco 16 mm



mm	mm	L mm	€	Icon	Code
10	16	40	15,70	2	007270110
12	16	40	15,70	2	007270112
13	16	40	15,70	2	007270113
14	16	40	15,70	2	007270114
16	16	40	16,90	2	007270116
17	16	40	16,90	2	007270117
18	16	40	17,60	2	007270118
19	16	40	17,60	2	007270119
22	16	40	20,30	2	007270122

727/ES16TX

inserti Macchina maschio per viti con impronta Torx®, attacco 16 mm



Icon	mm	L mm	€	Icon	Code
T55	16	50	23,70	2	007270355
T60	16	50	23,70	2	007270360
T70	16	50	23,70	2	007270370

727/ES16XZN

inserti Macchina maschio per viti con impronta XZN®, attacco 16 mm



Icon	mm	L mm	€	Icon	Code
M6	16	60	28,50	2	007270606
M8	16	60	28,50	2	007270608
M10	16	60	28,50	2	007270610
M12	16	60	28,50	2	007270612
M14	16	60	28,50	2	007270614
M16	16	60	28,50	2	007270616
M18	16	60	39,50	2	007270618

Beta

Beta

727PI/22

bussola portainseri Macchina per 727/ES22 e 727/ES22TX



Ø mm	L mm	Ø mm	€		
54	70	22	72,00	2	007270022

727/ES22

inserti Macchina maschio esagonale, attacco 22 mm



mm	● mm	L mm	€		
19	22	50	20,30	2	007270219
22	22	50	20,30	2	007270222
24	22	50	22,40	2	007270224
27	22	50	25,00	2	007270227
30	22	50	30,00	2	007270230
32	22	50	32,50	2	007270232

727/ES22TX

inserti Macchina maschio per viti con impronta Torx®, attacco 22 mm



⊕ mm	● mm	L mm	€		
T80	22	60	33,00	2	007270480
T90	22	60	33,00	2	007270490
T100	22	60	33,00	2	007270500

727/C16

12 inserti Macchina maschio e 4 accessori



727/C16	€		
	452,00	1	007270900

- 727PI/16
- 727/ES16 14-17-19 mm
- 727/ES16TX T55-T60-T70
- 727PI/22
- 727/ES22 22-24-27 mm
- 727/ES22TX T80-T90-T100
- 96BPC 3-4 mm

335x145x60 mm - 3,6 kg

727PI/32

bussola portainseri Macchina per 727/ES32



Ø mm	L mm	Ø mm	€		
86	66	32	179,00	1	007270032

727/ES32

inserti Macchina maschio esagonale attacco 32 mm



mm	● mm	L mm	€		
19	32	44	46,00	2	007270519
22	32	44	46,00	2	007270522
24	32	44	46,00	2	007270524
27	32	44	46,00	2	007270527
30	32	44	46,00	2	007270530
32	32	44	46,00	2	007270532
36	32	44	51,50	2	007270536

728

chiavi a bussola Macchina serie normale



UNI/ISO 2725 DIN 3129

⊕ mm	Ø mm	L mm	Ø1 mm	€	
17	30,0	51	44	26,50	2 007280017
18	31,0	51	44	26,50	2 007280018
19	32,5	51	44	26,50	2 007280019
21	35,0	51	44	26,50	2 007280021
22	36,0	51	44	26,50	2 007280022
23	37,5	51	44	27,00	2 007280023
24	38,5	51	44	27,00	2 007280024
27	42,5	53	44	27,00	2 007280027
28	44,0	53	44	27,50	2 007280028
30	46,0	53	44	28,50	2 007280030
32	48,5	57	44	30,00	2 007280032
33	50,0	57	44	32,00	2 007280033
34	51,0	57	44	32,00	2 007280034
35	52,5	57	44	33,00	2 007280035
36	53,5	57	44	34,00	2 007280036
38	56,0	57	44	38,00	1 007280038
40	58,5	58	44	40,50	1 007280040
41	60,0	58	44	41,00	1 007280041
44	64,0	62	44	44,50	1 007280044
45	65,0	62	44	48,00	1 007280045
46	66,0	62	44	48,50	1 007280046
50	71,0	68	54	57,00	1 007280050
55	77,5	71	54	63,50	1 007280055
60	83,0	73	54	72,50	1 007280060
65	88,0	78	54	80,50	1 007280065

728/C10

10 chiavi a bussola Macchina



728/C10	€		
17-19-22-24-27-30-32-36-41-46 mm	355,00	1	007280910

275x120x65 mm - 5,7 kg

728B

chiavi a bussola Macchina bocca poligonale



UNI/ISO 2725 DIN 3129

⊕ mm	Ø mm	L mm	Ø1 mm	€	
17	28,5	50	38	26,50	2 007280117
19	30	52	38	26,50	2 007280119
21	32	52	38	26,50	2 007280121
22	34	52	38	26,50	2 007280122
23	35	52	38	27,00	2 007280123
24	36	52	38	27,00	2 007280124
27	40	52	40	27,00	2 007280127
29	42	52	42	28,00	2 007280129
30	44	52	44	28,50	2 007280130
32	48	52	44	30,00	2 007280132
33	50	56	44	32,00	2 007280133
34	51	56	44	32,00	2 007280134
35	52	56	44	33,00	2 007280135
36	53,5	56	44	34,00	2 007280136
38	56	56	44	38,00	1 007280138
41	60	58	44	41,00	1 007280141
46	67	63	44	48,50	1 007280146

728B/C10

10 chiavi a bussola Macchina bocca poligonale



728B/C10	€		
17-19-22-24-27-30-32-36-41-46 mm	355,00	1	007280930

275x120x65 mm - 5,7 kg



728AS

chiavi a bussola Macchina
serie normale



mm	Ø mm	L mm	Ø1 mm	€		
3/4	32,0	51	41	26,50	1	007280219
13/16	35,0	51	41	27,00	1	007280221
7/8	36,0	51	41	27,00	1	007280222
15/16	38,5	51	41	27,00	1	007280224
1	40,0	53	41	27,50	1	007280225
1.1/16	42,5	53	44	29,50	1	007280227
1.1/8	44,0	53	44	30,00	1	007280230
1.1/4	48,5	57	44	30,50	1	007280232
1.5/16	50,0	57	44	32,00	1	007280233
1.7/16	53,5	57	44	34,00	1	007280236
1.1/2	56,0	57	44	37,50	1	007280238
1.5/8	60,0	58	44	41,00	1	007280241

728FTX

chiavi a bussola Macchina
per viti con testa a profilo Torx®



	Ø mm	L mm	Ø1 mm	€		
E20	28,5	50	44	35,50	2	007280420
E22	30,0	50	44	35,50	2	007280422
E24	32,5	50	44	35,50	2	007280424

728ME

chiavi a bussola Macchina
maschio esagonale



mm	Ø mm	L mm	L1 mm	€		
12	44	100	67	31,00	3	007280712
14	44	100	67	34,50	3	007280714
17	44	100	67	34,50	3	007280717
19	44	100	67	34,50	3	007280719
22	44	100	67	40,50	3	007280722
24	44	100	67	40,50	3	007280724

728ME/C6

6 chiavi a bussola Macchina
maschio esagonale



728ME/C6	255,00	1	007280906
12-14-17-19-22-24 mm			

335x145x60 mm - 4,0 kg

728L

chiavi a bussola Macchina
serie lunga



mm	Ø mm	L mm	Ø1 mm	€		
17	30	90	44	42,00	2	007280317
19	32,5	90	44	42,00	2	007280319
21	35,0	90	44	42,00	2	007280321
22	36,0	90	44	42,00	2	007280322
24	38,5	90	44	42,00	2	007280324
26	41,0	90	44	42,00	2	007280326
27	42,5	90	44	42,00	2	007280327
30	46,0	90	44	43,50	2	007280330
32	48,5	90	44	46,00	2	007280332
33	50,0	90	44	49,00	1	007280333
34	51,0	90	44	52,00	1	007280334
36	53,5	90	44	54,00	1	007280336
38	56,0	90	44	63,00	1	007280338
41	60,0	90	44	64,50	1	007280341
44	64,0	90	44	74,00	1	007280344
46	66,0	90	44	74,00	1	007280346
50	71,0	90	44	88,50	1	007280350
55	77,5	100	54	116,50	1	007280355



728L/S3	143,50	1	007280393
30-32-36 mm			

728LS

chiavi a bussola Macchina
serie lunga sottile



mm	Ø mm	L mm	Ø1 mm	€		
17	28,0	100	43	47,50	2	007280517
19	30,5	100	43	47,50	2	007280519
22	34,3	100	43	48,50	2	007280522
24	36,8	100	43	48,50	2	007280524
27	40,5	100	43	48,50	2	007280527
30	44,3	100	43	48,50	2	007280530
32	46,8	100	43	52,00	2	007280532
33	48,0	100	43	53,50	2	007280533
36	51,8	100	43	62,50	1	007280536

728LQ

chiavi a bussola Macchina
serie lunga
(per dadi ruote ISUZU)



mm	L mm	Ø mm	Ø1 mm	€		
19	90	35	43,5	42,50	1	007280619
21	90	42	43,5	42,50	1	007280621

728/15

raccordo Macchina con attacco quadro
femmina 3/4" e maschio 1/2"



L mm	Ø mm	□	■	€		
58	38	3/4	1/2	33,00	2	007280810



E' assolutamente necessario commisurare la coppia di serraggio alla capacità del quadro maschio per evitare rotture o danni accidentali

728/16

raccordo Macchina con attacco quadro
femmina 3/4" e maschio 1"



L mm	Ø mm	□	■	€		
62	44	3/4	1	40,00	2	007280813

728/21

prolunga Macchina con attacchi quadri
maschio e femmina 3/4"



L mm	Ø mm	€		
175	44	49,00	2	007280815

728/22

prolunga Macchina con attacchi quadri
maschio e femmina 3/4"



L mm	Ø mm	€		
250	44	56,50	2	007280825

728/22L

prolunga Macchina con attacchi quadri
maschio e femmina 3/4"



L mm	Ø mm	€		
330	44	72,50	1	007280826

728/25

snodo Macchina con attacchi quadri maschio e femmina 3/4"



L mm	Ø mm	€	Icona	Icona
107,5	44	95,50	1	007280830

728/OR - 728/SP

anelli e spine per bussole e accessori Macchina



728 mm	728FTX mm	€	Icona	Icona
728/OR-15	728/15	2,01	5	007280925
728/OR	17+46 E20+E24	2,14	10	007280926
728/SP	17+46 E20+E24	2,81	10	007280916

729

chiavi a bussola Macchina serie normale



UNI/ISO 2725 DIN 3129

Ø mm	Ø mm	L mm	Ø1 mm	€	Icona	Icona
24	41,5	58	54	42,50	1	007290024
27	45,0	60	54	42,50	1	007290027
30	49,0	62	54	42,50	1	007290030
32	51,5	63	54	43,50	1	007290032
33	52,5	63	54	43,50	1	007290033
34	54,0	63	54	43,50	1	007290034
36	56,5	66	54	43,50	1	007290036
38	59,0	66	54	52,50	1	007290038
41	62,5	68	54	53,50	1	007290041
46	69,0	72	54	60,00	1	007290046
50	74,0	76	54	74,00	1	007290050
55	80,0	84	54	79,00	1	007290055
60	86,5	88	54	95,50	1	007290060
65	92,5	92	54	109,50	1	007290065
70	99,0	96	54	140,50	1	007290070
75	105,0	102	63	164,00	1	007290075
80	111,5	102	63	176,50	1	007290080

729L

chiavi a bussola Macchina serie lunga

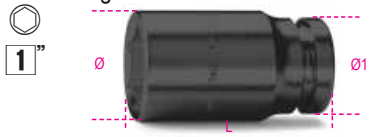

Ø mm	Ø mm	L mm	Ø1 mm	€	Icona	Icona
24	41,5	108	54	75,50	1	007290324
27	45,0	108	54	75,50	1	007290327
30	49,0	108	54	75,50	1	007290330
32	51,5	108	54	75,50	1	007290332
33	52,2	108	54	76,50	1	007290333
34	54,0	108	54	76,50	1	007290334
36	56,5	108	54	76,50	1	007290336
41	62,5	108	54	91,00	1	007290341
46	69,0	108	54	105,50	1	007290346
50	74,0	108	54	118,00	1	007290350

Ø mm	Ø mm	L mm	Ø1 mm	€	Icona	Icona
55	80,0	108	54	141,50	1	007290355
60	86,5	108	54	153,00	1	007290360
65	92,5	108	54	184,50	1	007290365
70	99,0	108	54	210,00	1	007290370
75	105,0	108	63	237,00	1	007290375
80	111,5	108	63	249,00	1	007290380

729LS

chiavi a bussola Macchina serie lunga sottile



Ø mm	Ø mm	L mm	Ø1 mm	€	Icona	Icona
22	36,0	108	53	75,50	1	007290522
24	38,5	108	53	75,50	1	007290524
27	46,0	108	53	75,50	1	007290527
30	50,0	108	53	80,00	1	007290530
32	50,0	108	53	80,00	1	007290532
33	52,0	108	53	80,00	1	007290533
36	56,0	108	53	80,00	1	007290536

729T

barre di torsione Macchina per dadi ruote



Ø mm	Nm	L mm	€	Icona	Icona
24	350	300	147,00	1	007290724
27	450	300	147,00	1	007290757
30	500	300	148,50	1	007290730
32	450	300	151,00	1	007290732
32	600	300	151,00	1	007290762
33	600	300	158,50	1	007290763
36	600	300	168,00	1	007290736

729/15

raccordo Macchina con attacco quadro femmina 1" e maschio 3/4"



L mm	Ø mm	Icona	Icona	€	Icona	Icona
66,5	54	1	3/4	50,50	1	007290810



E' assolutamente necessario commisurare la coppia di serraggio alla capacità del quadro maschio per evitare rotture o danni accidentali

729/16

raccordo Macchina con attacco quadro femmina 1" e maschio 1.1/2"



L mm	Ø mm	Icona	Icona	€	Icona	Icona
88	54,0	1	1.1/2	83,00	1	007290813

729/21

prolunga Macchina con attacchi quadri maschio e femmina 1"



L mm	Ø mm	€	Icona	Icona
175	54	77,50	1	007290815

729/21L

prolunga Macchina con attacchi quadri maschio e femmina 1"



L mm	Ø mm	€	Icona	Icona
250	54	94,50	1	007290826

729/22

prolunga Macchina con attacchi quadri maschio e femmina 1"



L mm	Ø mm	€	Icona	Icona
330	54	111,00	1	007290825

729/25

snodo Macchina con attacchi quadri maschio e femmina 1"



L mm	Ø mm	€	Icona	Icona
130	54	160,50	1	007290830

729/OR... - 729/SP..

anelli e spine per bussole e accessori Macchina



728 mm	729-730 mm	€	Icona	Icona
729/OR1	50+60 24+70	2,19	5	007290927
729/OR2	75+125	3,40	5	007290928
729/SP1	50+60 24+70	2,06	5	007290917
729/SP2	75+125	3,40	5	007290918

730

chiavi a bussola Macchina serie normale



UNI/ISO 2725 DIN 3129

Ø mm	Ø mm	L mm	Ø1 mm	€	Icon	Code
50	81	87	84	221,00	1	007300050
55	88	90	86	226,50	1	007300055
60	94	95	86	250,00	1	007300060
65	100	100	86	274,00	1	007300065
70	106	105	86	324,00	1	007300070
75	113	110	86	376,00	1	007300075
80	119	115	86	430,00	1	007300080
85	125	120	86	476,00	1	007300085
90	132	125	86	542,00	1	007300090
95	138	125	96	631,00	1	007300095
100	144	130	96	733,00	1	007300100
105	150	135	96	817,00	1	007300105
110	157	140	96	888,00	1	007300110
115	163	140	96	955,00	1	007300115
120	169	145	96	1.068,00	1	007300120
125	175	145	96	1.115,00	1	007300125

730L

chiavi a bussola Macchina serie lunga



Ø mm	Ø mm	L mm	Ø1 mm	€	Icon	Code
50	81	135	86	353,00	1	007300350
55	87	140	86	362,00	1	007300355
60	93	150	86	401,00	1	007300360
65	97	150	86	439,00	1	007300365
70	105	160	86	519,00	1	007300370
75	110	170	86	602,00	1	007300375
80	116	170	86	689,00	1	007300380
85	125	170	86	762,00	1	007300385
90	130	170	86	867,00	1	007300390
95	137	180	95	1.010,00	1	007300395
100	144	190	95	1.173,00	1	007300400
105	150	190	95	1.305,00	1	007300405
110	156	200	95	1.420,00	1	007300410
115	160	200	95	1.530,00	1	007300415
120	168	210	95	1.710,00	1	007300420

730/15

raccordo Macchina riduttore



L mm	Ø mm	□	■	€	Icon	Code
105	84,0	1.1/2	1	173,00	1	007300810



E' assolutamente necessario commisurare la coppia di serraggio alla capacità del quadro maschio per evitare rotture o danni accidentali

730/21

prolunga Macchina con attacchi quadri maschio e femmina 1.1/2"



L mm	Ø mm	€	Icon	Code
250	86	632,00	1	007300822

730/25

snodo Macchina con attacchi quadri maschio e femmina 1.1/2"



L mm	Ø mm	€	Icon	Code
150	86	663,00	1	007300830

733/15

raccordo Macchina riduttore



L mm	Ø mm	□	■	€	Icon	Code
156	127	2.1/2	1.1/2	608,00	1	007330810



INSERTI PER AVVITATORI

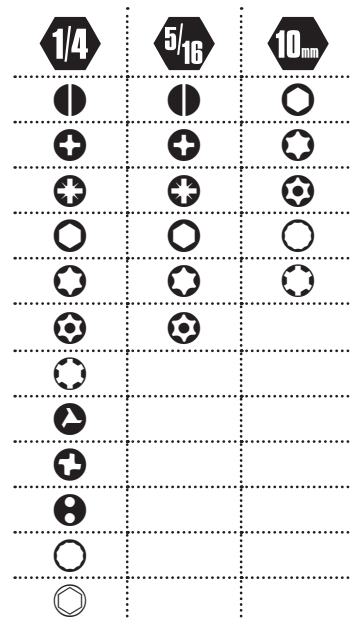

ISO 1173-C 6,3



sede per molla di tenuta

ISO 1173-E 6,3



cava per sfera di tenuta

851

portainseri magnetico con impugnatura



L1 mm	L mm	€	Icon	Code
45	165	17,00	2	008510165
125	245	19,70	2	008510245

851SR

portainseri a sgancio rapido con impugnatura



L mm	L1 mm	€	Icon	Code
230	110	23,40	2	008510001

852

portainseri a T snodato

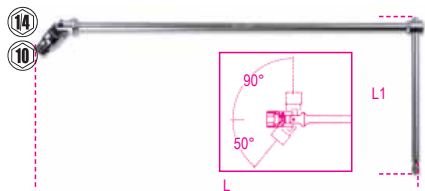

Ø	L mm	L1 mm	€	🛒	📄
1/4"	400	160	48,50	2	008520006
10 mm	400	160	48,50	2	008520010

855P

Giravite portainseri a cricchetto reversibile con impugnatura snodata 7 inserti integrati



L mm	L1 mm	€	🛒	📄
240	100	77,00	1	008550010

	860PH	PH1 - PH2
	860PZ	PZ1 - PZ2
	860LP	LP 0,8x5,5 mm
	860PE	4 - 5 mm

860LP

inserti colorati per avvitatori per viti a testa con intaglio



ISO 2351-1
ISO 1173 C 6,3

SxA mm	L mm	€	🛒	📄
0,5x3	25	2,02	5	008600005
0,6x4,5	25	2,02	5	008600010
0,8x5,5	25	2,02	5	008600015
1x5,5	25	2,02	5	008600020
1,2x6,5	25	2,02	5	008600025

860PH

inserti colorati per avvitatori per viti con impronta a croce Phillips®



ISO 2351-2
ISO 1173 C 6,3

PH	L mm	€	🛒	📄
0	25	2,02	5	008600220
1	25	2,02	5	008600225
2	25	2,02	5	008600230
3	25	2,02	5	008600245
4	25	2,92	5	008600250

860PZ

inserti colorati per avvitatori per viti con impronta a croce Pozidriv® - Supadriv®



ISO 2351-2
ISO 1173 C 6,3

PZ	L mm	€	🛒	📄
1	25	2,02	5	008600320
2	25	2,02	5	008600325
3	25	2,02	5	008600330
4	25	2,92	5	008600335

860PE

inserti colorati maschio esagonale per avvitatori



ISO 2351-3
ISO 1173 C 6,3

mm	L mm	€	🛒	📄
2	25	2,15	5	008600101
2,5	25	2,15	5	008600102
3	25	2,15	5	008600103
4	25	2,15	5	008600104
5	25	2,15	5	008600105
6	25	2,15	5	008600106
8	25	2,70	5	008600108
10	25	2,70	5	008600110

860TX

inserti colorati per avvitatori per viti con impronta Torx®



ISO 1173 C 6,3

T	L mm	€	🛒	📄
T6	25	2,70	5	008600704
T7	25	2,70	5	008600705
T8	25	2,70	5	008600710
T9	25	2,70	5	008600715
T10	25	2,15	5	008600720
T15	25	2,15	5	008600725
T20	25	2,15	5	008600730
T25	25	2,15	5	008600735
T27	25	2,15	5	008600740
T30	25	2,15	5	008600745
T40	25	2,15	5	008600750

860RTX

inserti colorati per avvitatori per viti con impronta Tamper Resistant Torx®



ISO 1173 C 6,3

T	L mm	€	🛒	📄
T9	25	2,92	5	008600550
T10	25	2,92	5	008600555
T15	25	2,92	5	008600560
T20	25	2,92	5	008600565
T25	25	2,92	5	008600570
T27	25	2,92	5	008600575
T30	25	2,92	5	008600580
T40	25	2,92	5	008600585

860/55

cricchetto reversibile portainseri



L mm	Ø mm	€	🛒	📄
100	1/4	34,50	3	008600870

860/58

cricchetto portainseri con impugnatura rotante

- L'inserto si può inserire su entrambi i lati per avvitare o svitare
- Impugnatura bimateriale



L mm	Ø mm	A mm	€	🛒	📄		
860/58	126	1/4"	27	15	79,00	1	008600884

860/C27

25 inserti per avvitatori, 1 raccordo e 1 cricchetto reversibile in astuccio tascabile



€	🛒	📄
93,50	1	008600880

	860/55	100 mm
	860LP	0,5x3-1,0x5,5-1,2x6,5 mm
	860PH	PH1-PH2(x2)-PH3
	860PZ	PZ1-PZ2(x2)-PZ3
	860PE	2-2,5-3-4-5-6 mm
	860TX	T6-T8-T10-T15-T20-T25-T30-T40
	892/0	● 1/4 ■ 1/4

860PHZ/A10

10 inserti con portainseri magnetico in astuccio tascabile



€	🛒	📄
39,00	1	008600910

	860PH	PH1	n.
		PH2	1
		PH3	3
	860PZ	PZ1	1
		PZ2	1
		PZ3	3
	882M1	○ 1/4 ● 1/4	1

860PE/A10

10 inserti con portainseri magnetico in astuccio tascabile



860PE/A10 € 40,50 1 008600920

	860PE	2 - 2,5 mm	n.
	882M1	3 - 4 - 5 - 6 mm	1
		○ 1/4 ● 1/4	2

860TX/A10

10 inserti con portainseri magnetico in astuccio tascabile



860TX/A10 € 41,50 1 008600970

	860TX	T7 - T8 - T9 - T10 - T15 - T20	n.
	882M1	T25 - T27 - T30 - T40	1
		○ 1/4 ● 1/4	

860MIX/A10

10 inserti con portainseri magnetico in astuccio tascabile



860MIX/A10 € 39,00 1 008600900

	860LP	0,5x3 - 1x5,5 - 1,2x6,5 mm	n.
	860PH	PH1	1
		PH2	2
		PH3	1
	860PZ	PZ1 - PZ2 - PZ3	1
	882M1	○ 1/4 ● 1/4	

860MIX/A31

30 inserti con portainseri magnetico a sgancio rapido in astuccio tascabile



860MIX/A31 € 92,00 1 008600902

	860LP	0,5x3 - 0,6x4,5 - 0,8x5,5 1,0x5,5 - 1,2x6,5 mm
	860PE	2 - 2,5 - 3 - 4 - 5 - 6 8 - 10 mm
	860PH	PH0 - PH1 - PH2 - PH3 - PH4
	860PZ	PZ1 - PZ2 - PZ3 - PZ4
	860RTX	T9 - T10 - T15 - T20 T25 - T27 - T30 - T40
	882MSR 50	○ 1/4 ● 1/4

860/C38P

1 portainseri con impugnatura a criccheto reversibile, 27 inserti per avvitatori, 8 bussole esagonali e 2 accessori



860/C38P € 203,00 1 008600878

	860LP	0,6x4,5-0,8x5,5-1,0x5,5-1,2x6,5 mm
	860PE	2-2,5-3-4(x2)-5(x2) mm
	860PH	PH1(x2)-PH2(x2)-PH3
	860PZ	PZ1(x2)-PZ2(x2)-PZ3
	860TX	T10-T15-T20-T25-T30-T40
	900	5-5,5-6-7-8-9-10-13 mm
	892/0	● 1/4 ■ 1/4
	892/3	● 1/4 ■ 1/4
	855P	240 mm

270x120x45 mm

861LP

inserti per avvitatori per viti a testa con intaglio



ISO 2351-1

ISO 1173 C 6,3

SxA mm	L mm	€		
0,5x3	25	1,31	10	008610005
0,6x4	25	1,31	10	008610007
0,6x4,5	25	1,31	10	008610010
0,8x5,5	25	1,31	10	008610015
1x5,5	25	1,31	10	008610020
1,2x6,5	25	1,31	10	008610025
1,2x8	25	2,50	10	008610028
1,6x8	25	2,50	10	008610030

861PH

inserti per avvitatori per viti con impronta a croce Phillips®



ISO 2351-2

ISO 1173 C 6,3

PH mm	L mm	€		
0	25	1,29	10	008610200
1	25	1,29	10	008610205
2	25	1,29	10	008610210
2L	50	2,50	10	008610213
3	25	1,29	10	008610215
4	25	3,45	10	008610220

861PH/C

inserti per avvitatori per viti con impronta a croce Phillips®



ISO 2351-2

ISO 1173 C 6,3

PH mm	L mm	€		
0	25	0,98	200	008610250
1	25	0,98	200	008610255
2	25	0,98	200	008610260
2L	50	1,89	100	008610263
3	25	0,98	200	008610265
4	25	2,54	100	008610270

861PZ

inserti per avvitatori per viti con impronta a croce Pozidriv® - Supadriv®



ISO 2351-2

ISO 1173 C 6,3

PZ mm	L mm	€		
1	25	1,29	10	008610300
2	25	1,29	10	008610305
2L	50	2,48	10	008610308
3	25	1,29	10	008610310
4	25	3,45	10	008610315

Beta

861PZ/C

inserti per avvitatori
per viti con impronta a croce
Pozi driv® - Supadriv®

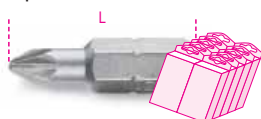

ISO 2351-2
ISO 1173 C 6,3

PZ	L mm	€		
1	25	0,98	200	008610350
2	25	0,98	200	008610355
2L	50	1,89	100	008610358
3	25	0,98	200	008610360
4	25	2,50	100	008610365

861PE

inserti maschio esagonale
per avvitatori



ISO 2351-3
ISO 1173 C 6,3

mm	L mm	€		
2	25	1,38	10	008610100
2,5	25	1,38	10	008610105
3	25	1,38	10	008610110
4	25	1,38	10	008610115
5	25	1,38	10	008610120
6	25	1,38	10	008610125
8	25	2,08	10	008610130
10	25	2,75	10	008610135

861TX

inserti per avvitatori
per viti con impronta Torx®



ISO 1173 C 6,3

⊕	L mm	€		
T5	25	1,83	10	008610399
T6	25	1,83	10	008610400
T7	25	1,83	10	008610405
T8	25	1,83	10	008610410
T9	25	1,83	10	008610415
T10	25	1,44	10	008610420
T15	25	1,44	10	008610425
T20	25	1,44	10	008610430
T25	25	1,44	10	008610435
T27	25	1,44	10	008610440
T30	25	1,44	10	008610445
T40	25	1,44	10	008610450

861TX/C

inserti per avvitatori
per viti con impronta Torx®

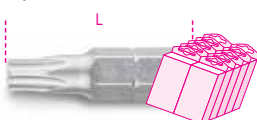

ISO 1173 C 6,3

⊕	L mm	€		
T10	25	1,11	200	008610470
T15	25	1,11	200	008610475
T20	25	1,11	200	008610480
T25	25	1,11	200	008610485
T27	25	1,11	200	008610490
T30	25	1,11	200	008610495
T40	25	1,11	200	008610499

861RTX

inserti per avvitatori per viti
con impronta Tamper Resistant Torx®



ISO 1173 C 6,3

⊕	L mm	€		
T6	25	2,70	10	008610537
T7	25	2,70	10	008610538
T8	25	2,70	10	008610540
T9	25	2,70	10	008610500
T10	25	2,70	10	008610505
T15	25	2,70	10	008610510
T20	25	2,70	10	008610515
T25	25	2,70	10	008610520
T27	25	2,70	10	008610525
T30	25	2,70	10	008610530
T40	25	2,70	10	008610535
T45	25	5,25	10	008610539

861RIBE

inserti per avvitatori
per viti con impronta RIBE®



ISO 1173 C 6,3

⊕	L mm	€		
M5	25	1,18	10	008610705
M6	25	1,18	10	008610706
M7	25	1,44	10	008610707
M8	25	1,44	10	008610708
M9	25	2,08	10	008610709

861TRW

inserti per avvitatori
per viti con impronta Tri-Wing®



ISO 1173 C 6,3

GR	L mm	€		
1	25	2,29	10	008610601
2	25	2,29	10	008610602
3	25	2,29	10	008610603
4	25	2,29	10	008610604
5	25	2,29	10	008610605
6	25	3,35	10	008610606

861TQS

inserti per avvitatori
per viti con impronta Torq-Set®



ISO 1173 C 6,3

GR	L mm	€		
0	25	2,29	10	008610620
1	25	2,29	10	008610621
2	25	2,29	10	008610622
3	25	2,29	10	008610623
4	25	2,29	10	008610624
5	25	2,29	10	008610625
6	25	2,29	10	008610626
8	25	2,29	10	008610628
10	25	2,29	10	008610630

861SP

inserti per avvitatori per viti con impronta
Spanner



ISO 1173 C 6,3

SP	D mm	L mm	€		
4	1,5	25	1,89	10	008610650
6	2,4	25	1,89	10	008610653
8	2,8	25	1,89	10	008610656
10	3,3	25	1,89	10	008610658
12	3,9	25	1,89	10	008610660

1483KV-PT/S7



1483KV PT/S7

185

861XZN

inserti per avvitatori
per viti con impronta XZN®



ISO 1173 C 6,3

⊕	L mm	€		
M5	25	1,18	10	008610725
M6	25	1,18	10	008610726
M8	25	1,51	10	008610728

861/C61P

61 inserti per avvitatori e 1 portainseri a sgancio rapido

1/4



861/C61P € 175,50 1 008610978

	● 861LP	0,5x3 - 0,6x4,5 - 0,8x5,5 - 1,0x5,5 1,2x6,5 - 1,2x8 - 1,6x8 mm
	○ 861PE	2 - 2,5 - 3 - 4 - 5 - 6 - 8 - 10 mm
	⊕ 861PH	PH0 - PH1 - PH2 - PH3
	⊕ 861PZ	PZ1 - PZ2 - PZ3
	⊗ 861TX	T6 - T7 - T8 - T9 - T10 - T15 T20 - T25 - T27 - T30 - T40
	⊗ 861RTX	T9 - T10 - T15 - T20 - T25 T27 - T30 - T40
	⊕ 861TRW	1 - 2 - 3 - 4 - 5 - 6
	⊕ 861TQS	0 - 1 - 2 - 3 - 4 - 5 - 6 - 8 - 10
	⊕ 861SP	4 - 6 - 8 - 10 - 12
	○ 851SR	1/4"

270x120x45 mm - 975 g

862LP

inserti per avvitatori per viti a testa con intaglio

1/4



ISO 2351-1
ISO 1173 E 6,3

SxA mm	L mm	€	5	008620005
0,5x3	50	3,75	5	008620005
0,6x4,5	50	3,75	5	008620010
0,8x5,5	50	3,75	5	008620015
1x5,5	50	3,75	5	008620020
1,2x6,5	50	3,75	5	008620025
1,2x8	50	4,65	5	008620030
1,6x8	50	4,65	5	008620035

862PH

inserti per avvitatori per viti con impronta a croce Phillips®

1/4



ISO 2351-2
ISO 1173 E 6,3

PH	L mm	€	5	008620200
1	50	3,75	5	008620200
2	50	3,75	5	008620205
3	50	3,75	5	008620210

862PH/L

inserti per avvitatori per viti con impronta a croce Phillips®

1/4



ISO 2351-2
ISO 1173 E 6,3

PH	L mm	€	5	008620230
1	70	6,90	5	008620230
2	70	6,90	5	008620232
3	70	6,90	5	008620234

862PH-XL

inserti per avvitatori per viti con impronta a croce Phillips®

1/4



ISO 2351-2ISO 1173 E 6,3

PH	L mm	€	5	008620250
1	100	7,10	5	008620250
2	100	7,10	5	008620252
3	100	7,10	5	008620254

862PZ

inserti per avvitatori per viti con impronta a croce Pozidriv® - Supadriv®

1/4



ISO 2351-2
ISO 1173 E 6,3

PZ	L mm	€	5	008620300
1	50	3,85	5	008620300
2	50	3,85	5	008620305
3	50	3,85	5	008620310

862PE

inserti maschio esagonale per avvitatori

1/4



ISO 2351-3
ISO 1173 E 6,3

mm	L mm	€	5	008620103
3	50	3,85	5	008620103
4	50	3,85	5	008620104
5	50	3,85	5	008620105
6	50	3,85	5	008620106
8	50	5,25	5	008620108

862TX

inserti per avvitatori per viti con impronta Torx®

1/4



ISO 1173 E 6,3

T	L mm	€	5	008620506
T6	50	5,20	5	008620506
T7	50	5,20	5	008620507
T8	50	5,20	5	008620508
T9	50	5,20	5	008620509
T10	50	5,20	5	008620510
T15	50	5,20	5	008620515
T20	50	5,20	5	008620520
T25	50	5,20	5	008620525
T27	50	5,20	5	008620527
T30	50	5,20	5	008620530
T40	50	5,20	5	008620540

862TX/L

inserti per avvitatori per viti con impronta Torx®

1/4



ISO 1173 E 6,3

T	L mm	€	5	008620556
T6	70	5,60	5	008620556
T7	70	5,60	5	008620557
T8	70	5,60	5	008620558
T9	70	5,60	5	008620559
T10	70	5,60	5	008620560
T15	70	5,60	5	008620565
T20	70	5,60	5	008620570
T25	70	5,60	5	008620575
T27	70	5,60	5	008620577
T30	70	5,60	5	008620580
T40	70	5,60	5	008620590

862TX-XL

inserti per avvitatori per viti con impronta Torx®

1/4



ISO 1173 E 6,3

T	L mm	€	5	008620659
T9	100	6,15	5	008620659
T10	100	6,15	5	008620660
T15	100	6,15	5	008620665
T20	100	6,15	5	008620670
T25	100	6,15	5	008620675
T27	100	6,15	5	008620677
T30	100	6,15	5	008620680
T40	100	6,15	5	008620690



862F

inserti per avvitatori
chiavi a bussola esagonale magnetici



ISO 1173 E 6,3

mm	L mm	Ø mm	€	📦	🚚
5,5	65	11	7,05	5	008620405
6	65	11	7,05	5	008620406
7	65	11	7,05	5	008620407
8	65	13	7,05	5	008620408
10	65	15	7,65	5	008620410
12	65	18	8,50	5	008620412
13	65	18	8,95	5	008620413

862F/A7

7 inserti per avvitatori chiavi a bussola
esagonale magnetici,
in astuccio tascabile



862F/A7 € 53,50 📦 1 🚚 008620950

862F 5,5-6-7-8-10-12-13 mm

862XP/A16

16 inserti Impact in astuccio tascabile



862XP/A16 € 71,00 📦 1 🚚 008620960

- ⊕ PH2(x2)-PH3
- ⊕ PZ2(x2)-PZ3
- ⊙ T20-T25(x2)
- ⊙ T30(x2)-T40(x2)
- ⊙ 4-5-6 mm



866LP

inserti per avvitatori
per viti a testa con intaglio



ISO 2351-1
ISO 1173 C 8

SxA mm	L mm	€	📦	🚚
1x5,5	41	3,85	10	008660005
1,2x6,5	41	3,85	10	008660010
1,6x8	41	3,85	10	008660015
1,6x10	41	5,25	10	008660020
2x12	41	6,55	10	008660025

866PH

inserti per avvitatori
per viti con impronta a croce Phillips®



ISO 2351-2
ISO 1173 C 8

PH	L mm	€	📦	🚚
1	32	3,15	10	008660200
2	32	3,15	10	008660205
3	32	3,15	10	008660210
4	38	4,70	10	008660215

866PZ

inserti per avvitatori
per viti con impronta a croce
Pozidriv® - Supadriv®

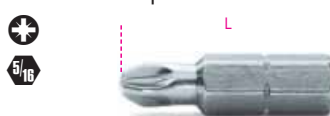

ISO 2351-2
ISO 1173 C 8

PZ	L mm	€	📦	🚚
1	32	3,30	10	008660300
2	32	3,30	10	008660305
3	32	3,30	10	008660310
4	38	4,90	10	008660315

866PE

inserti maschio esagonale
per avvitatori



ISO 2351-3
ISO 1173 C 8

mm	L mm	€	📦	🚚
3	30	2,70	10	008660100
4	30	2,70	10	008660105
5	30	2,70	10	008660110
6	30	2,70	10	008660115
7	30	2,70	10	008660117
8	30	2,70	10	008660120
10	30	3,75	10	008660125
12	30	5,25	10	008660132
14	30	6,75	10	008660134

866TX

inserti per avvitatori
per viti con impronta Torx®



ISO 1173 C 8

mm	L mm	€	📦	🚚
T20	30	3,40	10	008660400
T25	30	3,40	10	008660405
T27	30	3,40	10	008660410
T30	30	3,40	10	008660415
T40	30	3,40	10	008660420
T45	30	3,40	10	008660425
T50	30	3,40	10	008660430
T55	30	4,85	10	008660435
T60	30	6,55	10	008660440
T70	30	7,25	10	008660445

866RTX

inserti per avvitatori
per viti con impronta
Tamper Resistant Torx®



ISO 1173 C 8

mm	L mm	€	📦	🚚
T40	30	3,85	10	008660520
T45	30	3,85	10	008660525
T50	30	3,85	10	008660530
T55	30	5,45	10	008660535
T60	30	7,05	10	008660540
T70	30	8,75	10	008660545

867PE

inserti maschio esagonale



mm	L mm	€	📦	🚚
4	30	1,77	5	008670104
5	30	1,77	5	008670105
6	30	1,77	5	008670106
7	30	1,77	5	008670107
8	30	1,77	5	008670108
10	30	1,77	5	008670110
12	30	2,63	5	008670112

867PE/L

inserti maschio esagonale



mm	L mm	€	📦	🚚
4	75	3,30	5	008670154
5	75	3,30	5	008670155
6	75	3,30	5	008670156
7	75	3,30	5	008670157
8	75	3,30	5	008670158
10	75	3,30	5	008670160
12	75	4,60	5	008670162

867XZN

inserti a profilo XZN®



Ø	L mm	€	5	10
M4	30	2,21	5	008670204
M5	30	2,21	5	008670205
M6	30	2,21	5	008670206
M8	30	2,21	5	008670208
M10	30	2,21	5	008670210
M12	30	3,30	5	008670212

867XZN/L

inserti a profilo XZN®



Ø	L mm	€	5	10
M5	75	3,60	5	008670255
M6	75	3,60	5	008670256
M8	75	3,60	5	008670258
M10	75	3,60	5	008670260
M12	75	4,90	5	008670262

867TX

inserti per viti con impronta Torx®



Ø	L mm	€	5	10
T20	30	1,77	5	008670400
T25	30	1,77	5	008670405
T30	30	1,77	5	008670410
T40	30	1,77	5	008670415
T45	30	1,77	5	008670420
T50	30	1,77	5	008670425
T55	30	1,77	5	008670430

867TX/L

inserti per viti con impronta Torx®



Ø	L mm	€	5	10
T20	75	2,89	5	008670450
T25	75	2,89	5	008670455
T30	75	2,89	5	008670460
T40	75	2,89	5	008670465
T45	75	2,89	5	008670470
T50	75	2,89	5	008670475
T55	75	2,89	5	008670480

867RTX

inserti per viti con impronta
Tamper Resistant Torx®



Ø	L mm	€	5	10
T20	30	1,97	5	008670500
T25	30	1,97	5	008670505
T30	30	1,97	5	008670510
T40	30	1,97	5	008670515
T45	30	1,97	5	008670520
T50	30	1,97	5	008670525
T55	30	1,97	5	008670530

867RTX/L

inserti per viti con impronta
Tamper Resistant Torx®



Ø	L mm	€	5	10
T20	75	3,30	5	008670550
T25	75	3,30	5	008670555
T30	75	3,30	5	008670560
T40	75	3,30	5	008670565
T45	75	3,30	5	008670570
T50	75	3,30	5	008670575
T55	75	3,30	5	008670580

867RIBE

inserti per avvitatori
per viti con impronta RIBE®



Ø	L mm	€	5	10
M5	30	2,02	5	008670705
M6	30	2,02	5	008670706
M7	30	2,02	5	008670707
M8	30	2,02	5	008670708
M9	30	2,02	5	008670709
M10	30	2,02	5	008670710
M11	30	2,95	5	008670711
M12	30	2,95	5	008670712
M13	30	2,95	5	008670713

867RIBE/L

inserti per avvitatori
per viti con impronta RIBE®



Ø	L mm	€	5	10
M5	75	3,30	5	008670755
M6	75	3,30	5	008670756
M7	75	3,30	5	008670757
M8	75	3,30	5	008670758
M9	75	3,30	5	008670759
M10	75	3,30	5	008670760
M11	75	4,45	5	008670761
M12	75	4,45	5	008670762
M13	75	4,45	5	008670763

867/...

bussole portainseriti per 867



	Ø mm	□ mm	L mm	Ø mm	€	5	10
867/1	10	3/8"	38	17	6,35	5	008670600
867/2	10	1/2"	38	22	7,15	5	008670601

867/C20

18 inserti con impronta RIBE® con attacco
esagonale 10 mm e 2 accessori



867/C20	€	5	10
	125,50	1	008670920

867RIBE	5-6-7-8-9-10-11-12-13 mm
867RIBE/L	5-6-7-8-9-10-11-12-13 mm
867/1	
867/2	
335x145x60 mm - 1,7 kg	

867/C38

38 inserti con attacco esagonale 10 mm
e 1 portainseriti a T snodato



867/C38	€	5	10
	230,50	1	008670938

852	10 mm
867PE	4-5-6-7-8-10-12mm
867PE/L	4-5-6-7-8-10-12mm
867XZN	M5-M6-M8-M10-M12
867XZN/L	M5-M6-M8-M10-M12
867TX	T20-T25-T30-T40-T45-T50-T55
867TX/L	T20-T25-T30-T40-T45-T50-T55
882	
420x185x60 mm - 3 kg	

867/C52

52 inserti con attacco esagonale 10 mm e 2 accessori



867/C52 € 143,00 1 008670901

	867PE	4-5-6-7-8-10-12 mm
	867PE/L	4-5-6-7-8-10-12 mm
	867XZN	M5-M6-M8-M10-M12
	867XZN/L	M5-M6-M8-M10-M12
	867TX	T20-T25-T30-T40-T45-T50-T55
	867TX/L	T20-T25-T30-T40-T45-T50-T55
	867RTX	T20-T25-T30-T40-T45-T50-T55
	867RTX/L	T20-T25-T30-T40-T45-T50-T55
	867/1	○ 10 mm - □ 3/8"
	867/2	○ 10 mm - □ 1/2"

250x170x70 mm - 2,1 kg

852



852 1/4 79,116

882

portainseri con anello di ritegno per avvitatori



ISO 1173 E 6,3

L mm 57 1/4 1/4 11 € 17,60 5 008820001

882AN

rinvio angolare attacco esagonale 1/4"

- Per trapani elettrici con mandrino da 10 e 13 mm e avvitatori con attacco da 1/4"
- Velocità max 3600 giri/min.
- Coppia massima 30 Nm
- Con porta-inserti a cambio rapido
- Rapporto di trasmissione 1:1
- Collegamento all'utensile mediante esagono 1/4" D6.3



ISO 1173 E 6,3
ISO 1173 C 6,3

L mm 137 1/4 1/4 11 € 76,00 1 008820090

882M1

portainseri magnetico per avvitatori



ISO 1173 E 6,3

L mm 50 1/4 1/4 11 € 18,60 5 008820006

882M

portainseri magnetico per avvitatori



ISO 1173 E 6,3

L mm 75 1/4 1/4 11 € 22,50 5 008820005

882MSR

portainseri magnetico a sgancio rapido per avvitatori



ISO 1173 E 6,3

L mm 50 75 1/4 1/4 1/4 11 11 € 20,10 23,40 5 5 008820205 008820207

882P

prolunga portainseri magnetica



L mm 80 1/4 1/4 10 € 16,40 5 008820080



892

raccordi per avvitatori



892/0
892/1
892/2
892/3
892/4
892/5
892/6
892/7

	□	●	L mm	€	5	008920000
892/0	1/4	1/4	25	5,75	5	008920000
* 892/1	1/4	5,5	50	11,00	5	008920001
* 892/2	3/8	5,5	50	16,30	5	008920002
* 892/3	1/4	1/4	50	11,00	5	008920003
* 892/4	3/8	1/4	50	16,30	5	008920004
892/5	1/4	5/16	75	15,10	5	008920005
892/6	3/8	5/16	75	22,20	5	008920006
892/7	1/2	1/4	75	23,00	5	008920007

* ISO 1173 A 5,5
° ISO 1173 C 6,3

895

bussole portainseri per 860, 861, 862, 866



DIN 7427

	○	□	L mm	Ø mm	€	5	008950000
895/1	1/4	1/4	25,4	12	13,20	5	008950000
895/3	1/4	3/8	29	16,8	15,70	5	008950001
895/4	5/16	3/8	29	16,8	15,70	5	008950002
895/5	1/4	1/2	38	22	15,70	5	008950005
895/6	5/16	1/2	38	22	15,70	5	008950003

897

portainseri flessibile con impugnatura



L mm 280 L1 mm 154 € 30,00 2 008970010

897L

portainseri flessibile con impugnatura modello lungo



L mm 500 L1 mm 380 € 34,50 2 008970015

Ingombro minimo della testa



Spazio limitato di manovra, solo 5° grazie ai 72 denti della corona



Nessuna possibilità di slittamento o sganciamento sotto sforzo

- La pressione della mano sulla testa non provoca l'inversione e permette sempre il ritorno libero della leva
- Inversione con una sola mano
- Ottime caratteristiche meccaniche



Riduzione del carico di lavoro, 17 denti sempre in presa

900

chiavi a bussola a mano
bocca esagonale



UNI/ISO 2725 DIN 3124

Ø mm	Ø mm	L mm	Ø1 mm	€	10	10
3,2	6,6	25	11,8	4,10	10	009000032
4	6,8	25	11,8	4,10	10	009000040
4,5	7,4	25	11,8	4,10	10	009000045
5	8,0	25	11,8	4,10	10	009000050
5,5	8,7	25	11,8	4,10	10	009000055
6	9,3	25	11,8	4,10	10	009000060
7	10,4	25	11,8	4,10	10	009000070
8	11,8	25	12,7	4,10	10	009000080
9	12,7	25	11,8	4,10	10	009000090
10	14,2	25	12,0	4,10	10	009000100
11	15,8	25	12,5	4,10	10	009000110
12	17,2	25	13,5	4,10	10	009000120
13	18,0	25	13,5	4,15	10	009000130
14	20,0	25	15,0	4,20	10	009000140



900/SB13 € 72,50 1 009000150
4-4,5-5-5,5-6-7-8-9
10-11-12-13-14 mm

900MC

chiavi a bussola a mano
bocca esagonale
colorate



Ø mm	L mm	Ø mm	Ø1 mm	€	5	5
4	24,8	6,7	11,8	4,40	5	009002040
5	24,8	8,0	11,8	4,40	5	009002050
6	24,8	9,2	11,8	4,40	5	009002060
7	24,8	10,7	11,8	4,40	5	009002070
8	24,8	11,8	11,8	4,40	5	009002080
9	24,8	12,8	12,8	4,40	5	009002090
10	24,8	14,8	14,8	4,40	5	009002100
11	24,8	15,8	15,8	4,40	5	009002110
12	24,8	16,8	16,8	4,40	5	009002120
13	24,8	17,8	17,8	4,50	5	009002130
14	24,8	19,5	19,5	4,55	5	009002140



900MB

chiavi a bussola a mano
bocca poligonale



UNI/ISO 2725 DIN 3124

Ø mm	Ø mm	L mm	Ø1 mm	€	5	5
4	6,7	22	11,2	7,95	5	009000160
5	7,7	25	11,2	7,95	5	009000161
5,5	8,3	25	11,2	7,95	5	009000162
6	9,0	25	11,2	7,95	5	009000163
7	10,2	25	11,2	7,95	5	009000164
8	11,3	25	12,0	7,95	5	009000165
9	13,0	25	12,0	7,95	5	009000166
10	14,3	25	12,9	7,95	5	009000167
11	16,0	25	14,3	7,95	5	009000168
12	17,4	25	16,0	7,95	5	009000169
13	18,0	25	16,4	8,80	5	009000170
14	19,3	25	17,9	9,30	5	009000171



900MB/SB12 € 115,50 1 009000179
4-5-5,5-6-7-8-9-10
11-12-13-14 mm

900L

chiavi a bussola a mano lunghe
bocca esagonale



UNI/ISO 2725 DIN 3124

Ø mm	Ø mm	L mm	Ø1 mm	€	5	5
4	6,5	50	12,0	9,55	5	009000181
4,5	7,0	50	12,0	9,55	5	009000182
5	7,5	50	12,0	9,55	5	009000183
5,5	8,5	50	12,0	9,55	5	009000184
6	9,5	50	12,0	9,55	5	009000185
7	10,5	50	12,0	9,55	5	009000186
8	12,0	50	12,0	9,55	5	009000187
9	13,0	50	13,0	9,55	5	009000188
10	14,0	50	14,0	9,95	5	009000189
11	16,0	50	16,0	9,95	5	009000190
12	17,5	50	17,5	9,95	5	009000191
13	17,5	50	17,5	9,95	5	009000192
14	20,0	50	20,0	9,95	5	009000193



900L/SB13 € 145,00 1 009000203
4-4,5-5-5,5-6-7-8-9-10-11-12-13-14 mm

900MB/L

chiavi a bussola a mano lunghe
bocca poligonale



UNI/ISO 2725 DIN 3124

mm	Ø	L	Ø1	€		
mm	mm	mm	mm			
5	8,0	50	12,0	14,70	3	009000211
6	9,3	50	12,0	14,70	3	009000212
7	10,9	50	12,0	14,70	3	009000213
8	11,6	50	12,0	14,70	3	009000214
9	13,0	50	12,0	14,70	3	009000215
10	14,3	50	12,8	15,60	3	009000216
11	16,0	50	14,2	15,60	3	009000217
12	17,4	50	15,5	15,60	3	009000218
13	18,0	50	16,2	15,80	3	009000219
14	19,0	50	17,1	16,10	3	009000220

900AS

chiavi a bussola a mano
bocca esagonale



mm	Ø	L	Ø1	€		
mm	mm	mm	mm			
5/32	8,8	25	11,9	4,50	5	009000349
3/16	7,7	25	11,9	4,50	5	009000340
7/32	8,8	25	11,9	4,50	5	009000345
1/4	9,6	25	11,9	4,50	5	009000350
9/32	10,2	25	11,9	4,50	5	009000355
5/16	11,3	25	11,9	4,50	5	009000360
11/32	12,7	25	11,6	4,50	5	009000365
3/8	14,0	25	12,9	4,50	5	009000370
7/16	15,3	25	14,5	4,50	5	009000375
1/2	17,5	25	16,4	4,55	5	009000380
9/16	19,0	25	17,9	4,60	5	009000385



900AS/SB11

3/16-7/32-5/32-1/4-9/32-5/16
11/32-3/8-7/16-1/2-9/16

€ 66,50 1 009000389

900AS/MB

chiavi a bussola a mano
bocca poligonale



SAE AS 954E

mm	Ø	L	Ø1	€		
mm	mm	mm	mm			
3/16	7,7	22	10,9	8,10	2	009000390
7/32	8,5	22	10,9	8,10	2	009000391
1/4	9,4	22	10,9	8,10	2	009000392
9/32	10,2	22	10,9	8,10	2	009000393
5/16	11,3	22	11,7	8,10	2	009000394
11/32	12,5	22	12,0	8,10	2	009000395
3/8	13,7	22	12,9	8,65	2	009000396

mm	Ø	L	Ø1	€		
mm	mm	mm	mm			
7/16	15,6	22	14,3	8,65	2	009000397
1/2	17,2	22	16,4	9,60	2	009000398
9/16	18,8	24	17,9	9,70	2	009000399

900AS/L

chiavi a bussola a mano lunghe
bocca esagonale



SAE AS 954E

mm	Ø	L	Ø1	€		
mm	mm	mm	mm			
3/16	7,0	50	12,0	10,00	2	009000301
7/32	8,5	50	12,0	10,00	2	009000303
1/4	9,8	50	12,0	10,00	2	009000305
9/32	10,5	50	12,0	10,00	2	009000307
5/16	12,0	50	12,0	10,00	2	009000309
11/32	13,0	50	13,0	10,00	2	009000311
3/8	14,0	50	14,0	10,00	2	009000313
7/16	16,0	50	16,0	10,00	2	009000315
1/2	17,5	50	17,5	10,00	2	009000317
9/16	20,0	50	20,0	10,70	2	009000319

900AS/MBL

chiavi a bussola a mano lunghe
bocca poligonale



mm	Ø	L	Ø1	€		
mm	mm	mm	mm			
5/32	6,8	50	12,0	15,50	2	009000325
3/16	8,0	50	12,0	15,50	2	009000326
7/32	8,5	50	12,0	15,50	2	009000327
1/4	9,8	50	12,0	15,50	2	009000328
9/32	10,9	50	12,0	15,50	2	009000329
5/16	11,6	50	12,0	15,50	2	009000330
11/32	13,0	50	12,0	15,50	2	009000331
3/8	14,3	50	12,8	16,60	2	009000332
7/16	16,0	50	14,2	16,60	2	009000333
1/2	18,0	50	16,2	16,60	2	009000334
9/16	19,0	50	17,1	16,60	2	009000335

900U

chiavi a bussola a mano
bocca multimpronta



mm	"	Ø	Ø1	€		
mm		mm	mm			
4	5/32	E5	M5	4,30	5	009001702
4,5	3/16	E6		4,30	5	009001703
5	13/64		M6	4,30	5	009001704
5,5	7/32	E7		4,30	5	009001705
6	1/4	E8	M8	4,30	5	009001706
7	9/32			4,30	5	009001707
8	5/16	E10	M10	4,30	5	009001708
9	11/32			4,30	5	009001709
10	3/8	E12	M12	4,30	5	009001710
11	7/16	E14	M14	4,30	5	009001711
12	15/32	E16		4,30	5	009001712
13	1/2		M16	4,35	5	009001713
14	9/16	E18	M18	4,40	5	009001714

14"



900U/SB13

4-4,5-5-5,5-6-7-8-9
10-11-12-13-14 mm

€ 75,00 1 009001750

900FTX

chiavi a bussola a mano per viti
con teste a profilo Torx®



mm	Ø	L	Ø1	€		
mm	mm	mm	mm			
E4	5,4	22	11,2	7,60	5	009000404
E5	6,7	22	11,2	7,60	5	009000405
E6	7,7	22	11,2	7,60	5	009000406
E7	8,3	22	11,2	7,60	5	009000407
E8	9,6	22	11,2	7,60	5	009000408
E10	11,3	22	12,0	7,60	5	009000410
E11	12,1	22	12,5	10,40	5	009000411
E12	12,9	23	12,9	10,40	5	009000412
E14	14,0	25	14,0	10,40	5	009000414



900FTX/SB9

E4-E5-E6-E7-E8
E10-E11-E12-E14

€ 91,00 1 009000419

900LP

chiavi a bussola a giravite
per viti con intaglio

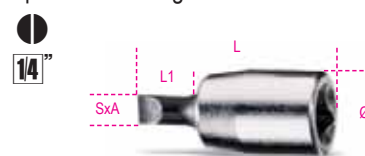

SxA	Ø	L	L1	€		
mm	mm	mm	mm			
0,8x4	12	28	9	9,20	5	009000605
1x5,5	12	28	9	9,20	5	009000610
1,2x6,5	12	28	9	9,20	5	009000615
1,2x8	13	28	8	9,20	5	009000620
1,6x10	14	28	8	9,20	5	009000625

900MC/LP

chiavi a bussola a giravite
per viti con intaglio colorate



SxA	Ø	L	L1	€		
mm	mm	mm	mm			
0,8x4	12	28	9	14,40	3	009002605
1,2x6,5	12	28	9	14,40	3	009002615
1,2x8	13	28	8	14,40	3	009002620

900PH

chiavi a bussola a giravite
per viti con impronta a croce Phillips®

1/4"



PH	Ø mm	L mm	L1 mm	€	🔧	📦
1	12	28	12	10,00	5	009000701
2	12	28	12	10,00	5	009000702
3	12	28	12	10,00	5	009000703
4	13	28	11	10,00	5	009000704

1/4"



900PH/SB4
PH1-PH2-PH3-PH4 € 48,50 1 009000708

900MC/PH

chiavi a bussola a giravite
per viti con impronta a croce Phillips® colorate

1/4"



PH	Ø mm	L mm	L1 mm	€	🔧	📦
1	12	28	12	15,00	3	009002701
2	12	28	12	15,00	3	009002702
3	12	28	12	15,00	3	009002703

900PZ

chiavi a bussola a giravite
per viti con impronta a croce Pozidriv®-
Supadriv®

1/4"



PZ	Ø mm	L mm	€	🔧	📦
1	12	28	10,50	3	009000711
2	12	28	10,50	3	009000712
3	12	28	10,50	3	009000713

900ME

chiavi a bussola a giravite
maschio esagonale

1/4"



mm	Ø mm	L mm	L1 mm	€	🔧	📦
2,5	12	25	4,5	8,65	5	009000502
3	12	25	5,0	8,65	5	009000503
4	12	25	5,6	8,65	5	009000504
5	12	25	6,3	8,65	5	009000505
6	12	25	7,6	8,65	5	009000506
7	13	25	7,2	8,65	5	009000507
8	13	25	8,0	8,65	5	009000508
10	13	25	8,7	10,70	5	009000510

1/4"



900ME/SB8 € 84,50 1 009000518
2,5-3-4-5-6-7-8-10 mm

900PE/AS

chiavi a bussola maschio esagonale

1/4"



"	Ø mm	L mm	€	🔧	📦
1/8	11,9	25	19,70	5	009000521
5/32	11,9	25	19,70	5	009000522
3/16	11,9	25	19,70	5	009000523
7/32	11,9	25	19,70	5	009000524
1/4	11,9	25	19,70	5	009000525
9/32	13,1	25	19,70	5	009000526
5/16	13,1	25	19,70	5	009000527

900PT

chiavi a bussola a giravite per viti con
impronta pentalobata

1/4"

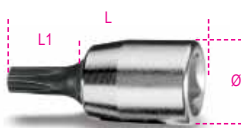

PT	Ø mm	L mm	L1 mm	€	🔧	📦
PT10	12	28	12	18,40	5	009000750
PT15	12	28	12	18,40	5	009000755
PT20	12	28	12	18,40	5	009000760
PT25	12	28	12	18,40	5	009000765
PT27	12	28	12	18,40	5	009000767
PT30	12	28	12	18,40	5	009000770

900TX

chiavi a bussola a giravite maschio
per viti con impronta Torx®

1/4"



T	Ø mm	L mm	L1 mm	€	🔧	📦
T6	12	28	12	13,40	5	009000717
T7	12	28	12	13,40	5	009000718
T8	12	28	12	13,50	5	009000719
T9	12	28	12	13,50	5	009000720
T10	12	28	12	13,50	5	009000721
T15	12	28	12	13,50	5	009000722
T20	12	28	12	13,50	5	009000723
T25	12	28	12	13,50	5	009000724
T27	12	28	12	13,50	5	009000725
T30	12	28	12	13,50	5	009000726
T40	12	28	12	13,50	5	009000727

1/4"



900TX/SB8 € 121,00 1 009000730
T9-T10-T15-T20
T25-T27-T30-T40

900MC/TX

chiavi a bussola a giravite maschio
per viti con impronta Torx® colorate

1/4"



T	Ø mm	L mm	L1 mm	€	🔧	📦
T10	12	28	12	15,50	3	009002721
T15	12	28	12	15,50	3	009002722
T20	12	28	12	15,50	3	009002723
T25	12	28	12	15,50	3	009002724
T27	12	28	12	15,50	3	009002725
T30	12	28	12	15,50	3	009002726
T40	12	28	12	15,50	3	009002727

900/16

raccordo con attacco quadro
femmina 1/4" e maschio 3/8"

1/4"



UNI/ISO 3316 DIN 3123

L mm	Ø mm	□	■	€	🔧	📦
28	13,0	1/4	3/8	7,05	5	009000814

900/...
 prolunghe con attacchi quadri
 maschio e femmina 1/4"

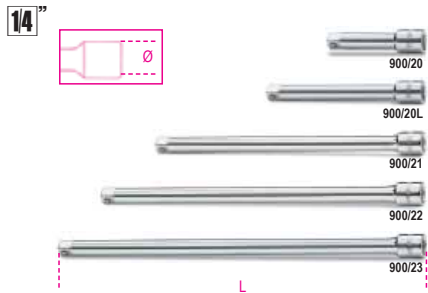

UNI/ISO 3316 DIN 3123

	L mm	Ø mm	€	5	009000818
900/20	50	11,5	8,95	5	009000818
900/20L	100	11,5	9,20	5	009000819
900/21	150	11,5	9,60	5	009000822
900/22	250	11,5	14,10	5	009000823
900/23	350	11,5	16,90	5	009000824

900AN
 prolunghe con attacchi quadri
 maschio e femmina 1/4"
 angolari

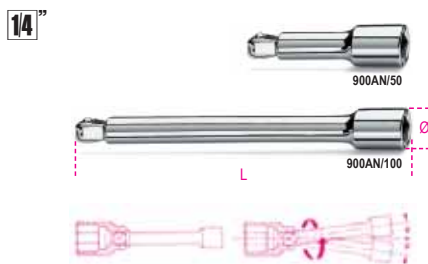

	L mm	Ø mm	€	3	009000825
900AN/50	50	11,5	9,70	3	009000825
900AN/100	100	11,5	10,70	3	009000826

900FL
 prolunga flessibile con attacchi quadri
 maschio e femmina 1/4"

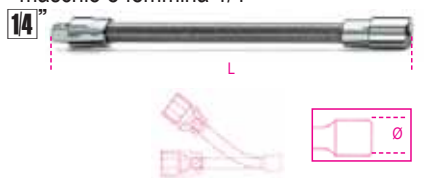

	L mm	Ø mm	€	3	009000828
900FL	150	12	14,30	3	009000828

900/25
 snodo con attacchi quadri
 maschio e femmina 1/4"



UNI/ISO 3316 DIN 3123

	L mm	Ø mm	€	5	009000830
900/25	41	12,5	17,40	5	009000830

900BG/30C
 quadro maschio 1/4"
 con impugnatura



UNI/ISO 3315 DIN 3122

	L mm	L1 mm	€	5	009000833
900BG/30C	128	20	8,55	5	009000833

900BG/30
 quadro maschio 1/4"
 con impugnatura

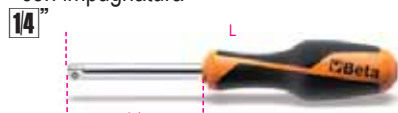

UNI/ISO 3315 DIN 3122

	L mm	L1 mm	€	5	009000834
900BG/30	176	68	8,95	5	009000834

900/32
 quadro maschio 1/4" flessibile
 con impugnatura



	L mm	L1 mm	€	2	009000839
900/32	280	154	20,60	2	009000839

900/35A
 quadro maschio 1/4" snodato
 con impugnatura



UNI/ISO 3315 DIN 3122

	L mm	L1 mm	€	5	009000840
900/35A	148	84	29,50	5	009000840

900M/35
 quadro maschio 1/4" snodato
 con impugnatura in metallo



UNI/ISO 3315
 DIN 3122

	L mm	€	3	009000845
900M/35	130	37,50	3	009000845



900/40
 quadro maschio 1/4" snodato a T



	L mm	L1 mm	€	3	009000843
900/40	390	145	39,50	3	009000843

900/42
 quadro maschio 1/4"
 con spina scorrevole

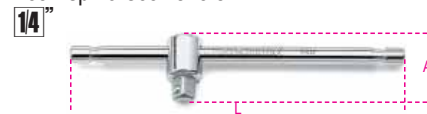

UNI/ISO 3315 DIN 3122

	L mm	A mm	€	5	009000854
900/42	115	22	9,80	5	009000854

900T/44
 quadro maschio 1/4" piegato
 con impugnatura di manovra



	L mm	L1 mm	€	2	009000860
900T/44	238	105	14,80	2	009000860

900/55
 cricchetto reversibile
 con attacco quadro maschio 1/4"
 meccanismo a 48 denti

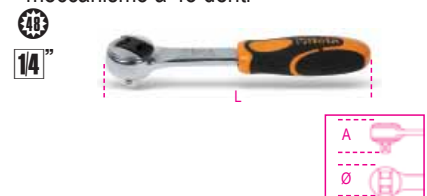

UNI/ISO 3315 DIN 3122

	L mm	Ø mm	A mm	€	5	009000870
900/55	125	25	29	47,00	5	009000870

900/55Z

72

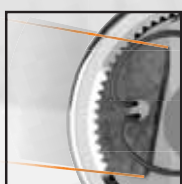

Il cricchetto 900/55Z è stato sviluppato dall'Ufficio Tecnico Beta con un nuovo meccanismo a 72 denti di cui 15 sempre in presa.

Il carico di lavoro è pertanto suddiviso su un grande numero di denti, in modo da diminuire l'usura del singolo elemento e offrire una vita di lavoro molto lunga.



I 72 denti garantiscono un angolo di ripresa di soli 5° e una testa molto compatta, per agire rapidamente anche negli spazi più ristretti.

L'impugnatura bimatereale ergonomica Beta permette di utilizzare il cricchetto sia in modo rapido che applicando maggiore forza.

900/55Z

cricchetto reversibile con attacco quadro maschio 1/4" meccanismo a 72 denti

72

1/4"

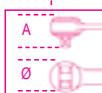

L mm	Ø mm	A mm	€	Impugnatura	Accessori
126	25	23	47,00	3	009000882

900M/55

cricchetto reversibile con attacco quadro maschio 1/4" con impugnatura in metallo

1/4"



UNI/ISO 3315
DIN 3122

L mm	Ø mm	A mm	€	Impugnatura	Accessori
110	22	18	60,50	3	009000905

Meccanismi rotanti di ricambio dei cricchetti, vedi tabella dopo l'art. 929/C8

900/58

cricchetto reversibile con impugnatura rotante con attacco quadro maschio 1/4" meccanismo a 52 denti

- Pulsante di rilascio della bussola
- Sistema di inversione a ghiera sulla testa del cricchetto
- Impugnatura bimatereale

1/4"

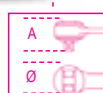

L mm	Ø mm	A mm	€	Impugnatura	Accessori
126	28	28,5	71,50	2	009000884

900/C39N

11 chiavi a bussola esagonali, 21 inserti e 7 accessori

1/4"

1/4"



900/C39N	€	Impugnatura	Accessori
	211,50	1	009000947

861LP	0,6x4,5 - 1,2x6,5 - 1,2x8 mm
861PH	PH1-PH2-PH3
861PZ	PZ1-PZ2-PZ3
861PE	2,5-3-4-5-6 mm
861RTX	T10-T15-T20-T25-T27-T30-T40
900	5-5,5-6-7-8-9-10-11-12-13-14 mm
900/20	50 mm
900/20L	100 mm
900/25	
900BG/30C	128 mm
892/0	
895/1	
900/55Z	126 mm

900/C39U

11 chiavi a bussola multimpronta, 21 inserti e 7 accessori

1/4"

1/4"



900/C39U	€	Impugnatura	Accessori
	213,50	1	009001947

861LP	0,6x4,5 - 1,2x6,5 - 1,2x8 mm
861PH	PH1-PH2-PH3
861PZ	PZ1-PZ2-PZ3
861PE	2,5-3-4-5-6 mm
861RTX	T10-T15-T20-T25-T27-T30-T40
900U	Ø 5-5,5-6-7-8-9-10-11-12-13-14 mm * 3/16-13/64-7/32-1/4-9/32-5/16 11/32-3/8-7/16-15/32-1/2-9/16 ⊙ E6-E7-E8-E10-E12-E14-E16-E18 ⊙ M6-M8-M10-M12-M14-M16-M18 50 mm
900/20	
900/20L	100 mm
900/25	
900BG/30C	128 mm
892/0	
895/1	
900/55Z	126 mm

900/C11

11 chiavi a bussola esagonali, 20 inserti per avvitatori e 8 accessori

1/4"

1/4"



900/C11	€	Impugnatura	Accessori
	230,00	1	009000971

861LP	0,5x3 - 0,8x5,5 1x5,5 - 1,2x6,5 mm
861PE	3 - 4 - 5 - 6 - 8 mm
861PH	0 - 1 - 2 - 3
861TX	T8 - T10 - T15 - T20 T25 - T30 - T40
895/1	
900	5 - 5,5 - 6 - 7 - 8 - 9 - 10 11 - 12 - 13 - 14 mm
900/16	□ 1/4 - ■ 3/8
900/20	50 mm
900/21	150 mm
900/25	
900BG/30	176 mm
900/42	
900/55	

270x120x45 mm - 1,2 kg

9899 900C11	€	Impugnatura	Accessori
termoformato vuoto	13,90	1	098990132

900/C11Z

11 chiavi a bussola esagonali,
20 inserti per avvitatori e 8 accessori

1/4"
1/4"



900/C11Z € 230,00 1 009000984

	861LP	0,5x3 - 0,8x5,5 - 1x5,5 - 1,2x6,5 mm
	861PE	3 - 4 - 5 - 6 - 8 mm
	861PH	0 - 1 - 2 - 3
	861TX	T8 - T10 - T15 - T20 T25 - T30 - T40
	895/1	
	900	5 - 5,5 - 6 - 7 - 8 - 9 - 10 11 - 12 - 13 - 14 mm
	900/16	□ 1/4 - ■ 3/8
	900/20	50 mm
	900/21	150 mm
	900/25	
	900BG/30	176 mm
	900/42	
	900/55Z	

≡ 350x150x50 mm - 1,2 kg

9899 900C11 € 13,90 1 098990132
termoformato vuoto

900/C12MR

12 chiavi a bussola esagonali,
20 inserti per avvitatori e 7 accessori
in termoformato morbido,
in cassetta di lamiera

• cricchetto con impugnatura rotante

1/4"
1/4"



900/C12MR € 257,00 1 009000962

	900	4-5-5,5-6-7-8-9-10-11-12-13-14 mm
	900/20	50 mm
	900/21	150 mm
	900/25	
	900/42	115 mm
	900BG/30	128 mm
	900/58	
	895/1	
	861TX	T8-T10-T15-T20-T25-T30-T40
	861PH	PH0-PH1-PH2-PH3
	861LP	0,5-0,8-1-1,2 mm
	861PE	3-4-5-6-8 mm

≡ 350x150x50 mm 1,3 kg



900/C12MZ

12 chiavi a bussola esagonali,
20 inserti per avvitatori e 7 accessori
in termoformato morbido

1/4"
1/4"



900/C12MZ € 232,50 1 009000983

	900	4-5-5,5-6-7-8-9-10-11-12-13-14 mm
	900/20	50 mm
	900/21	150 mm
	900/25	
	900/42	115 mm
	900BG/30	176 mm
	900/55Z	
	895/1	
	861TX	T8-T10-T15-T20-T25-T30-T40
	861PH	PH0-PH1-PH2-PH3
	861LP	0,5x3 - 0,8x5,5 - 1x5,5 - 1,2x6,5 mm
	861PE	3-4-5-6-8 mm

≡ 350x150x50 mm - 1,2 kg

900/C13-5

13 chiavi a bussola esagonali
e 5 accessori

1/4"



900/C13-5 € 186,50 1 009000953

	900	4 - 4,5 - 5 - 5,5 - 6 - 7 - 8 - 9 10 - 11 - 12 - 13 - 14 mm
	900/21	150 mm
	900/25	
	900BG/30	
	900/42	
	900/55	

≡ 270x120x45 mm - 1 kg

9899 900/C13-5 € 13,90 1 098990131
termoformato vuoto

900/C13-8

13 chiavi a bussola esagonali
e 8 accessori

1/4"



900/C13-8 € 226,00 1 009000954

	900	4 - 4,5 - 5 - 5,5 - 6 - 7 - 8 - 9 10 - 11 - 12 - 13 - 14 mm
	900/16	□ 1/4 - ■ 3/8
	900/20	50 mm
	900/21	150 mm
	900/25	
	900BG/30	
	900/35A	
	900/42	
	900/55	

≡ 270x120x45 mm - 1,1 kg

900MB/C19

11 chiavi a bussola poligonali
e 8 accessori

1/4"



900MB/C19 € 262,00 1 009000977

	900MB	5 - 5,5 - 6 - 7 - 8 - 9 - 10 - 11 12 - 13 - 14 mm
	900/16	□ 1/4 - ■ 3/8
	900/20	50 mm
	900/21	150 mm
	900/25	
	900BG/30	
	900/35A	
	900/42	
	900/55	

≡ 270x120x45 mm - 1,1 kg



900/C24

13 chiavi a bussola esagonali
11 a giravite e 6 accessori

1/4"



900/C24

€ 290,00

1 009000956

	900	4 - 4,5 - 5 - 5,5 - 6 - 7 - 8 - 9 10 - 11 - 12 - 13 - 14 mm
	900LP	0,8x4 - 1,2x6,5 - 1,2x8 mm
	900PH	PH1 - PH2 - PH3
	900ME	3 - 4 - 5 - 6 - 8 mm
	900/20	50 mm
	900/21	150 mm
	900/25	
	900BG/30	
	900/42	
	900/55	

270x120x45 mm - 1,1 kg

900MB/C28

11 chiavi a bussola poligonali
11 a giravite e 6 accessori

1/4"



900MB/C28

€ 327,00

1 009000979

	900MB	5 - 5,5 - 6 - 7 - 8 - 9 - 10 - 11 12 - 13 - 14 mm
	900LP	0,8x4 - 1,2x6,5 - 1,2x8 mm
	900PH	PH1 - PH2 - PH3
	900ME	3 - 4 - 5 - 6 - 8 mm
	900/20	50 mm
	900/21	150 mm
	900/25	
	900BG/30	
	900/42	
	900/55	

270x120x45 mm - 1,1 kg

900MC/C24

11 chiavi a bussola esagonali colorate
13 a giravite colorate e 6 accessori

1/4"



900MC/C24

€ 382,00

1 009002960

	900MC	4 - 5 - 6 - 7 - 8 - 9 10 - 11 - 12 - 13 - 14 mm
	900MC/PH	PH1 - PH2 - PH3
	900MC/TX	T10 - T15 - T20 - T25 - T27 - T30 - T40
	900MC/LP	0,8x4 - 1,2x6,5 - 1,2x8 mm
	900/20	50 mm
	900/21	150 mm
	900/25	
	900BG/30	
	900/42	
	900/55	

270x120x45 mm - 1 kg

900MC/C32

11 chiavi a bussola esagonali colorate,
20 inserti colorati per avvitatori e 7 accessori

1/4"



900MC/C32

€ 241,00

1 009002963

	900MC	4 - 5 - 6 - 7 - 8 - 9 - 10 - 11 - 12 - 13 - 14 mm
	860LP	0,5x3 - 0,8x5,5 - 1,0x5,5 - 1,2x6,5 mm
	860PH	0 - 1 - 2 - 3
	860PE	3 - 4 - 5 - 6 - 8 mm
	860TX	T8 - T10 - T15 - T20 - T25 - T30 - T40
	895/1	
	900/20	
	900/21	
	900/25	
	900BG/30	
	900/42	
	900/55	

270x120x45 mm - 1,2 kg

900U/C12M

12 chiavi a bussola mutimpronta,
20 inserti per avvitatori e 7 accessori
in termoformato morbido

1/4"

1/4"



900U/C12M

€ 235,00

1 009001792

	900U	○ 4-5-5,5-6-7-8-9-10-11-12-13-14 mm * 5/32-3/16-13/64-7/32-1/4-9/32-5/16 11/32-3/8-7/16-15/32-1/2-9/16 ◎ E5-E6-E7-E8-E10-E12-E14-E16-E18 ○ M5-M6-M8-M10-M12-M14-M16-M18
	900/20	50 mm
	900/21	150 mm
	900/25	
	900/42	115 mm
	900BG/30	176 mm
	900/55	125 mm
	895/1	○ 1/4 - □ 1/4
	861LP	0,5x3 - 0,8x5,5 - 1,0x5,5 - 1,2x6,5 mm
	861PE	3-4-5-6-8 mm
	861PH	PH0-PH1-PH2-PH3
	861TX	T8-T10-T15-T20-T25-T30-T40

350x150x50 mm - 1,2 kg



900AS/C10 - /MB-C17

10 chiavi a bussola e 7 accessori

14"



900AS/C10 € 211,00 1 009000961

	900AS	3/16 - 7/32 - 1/4 - 9/32 - 5/16 11/32 - 3/8 - 7/16 - 1/2 - 9/16
	900/20	50 mm
	900/21	150 mm
	900/25	
	900BG/30	
	900/35A	
	900/42	
	900/55	

270x120x45 mm - 1,1 kg

900AS/MB-C17 € 251,00 1 009000981

	900AS/MB	3/16 - 7/32 - 1/4 - 9/32 - 5/16 11/32 - 3/8 - 7/16 - 1/2 - 9/16
	900/20	50 mm
	900/21	150 mm
	900/25	
	900BG/30	
	900/35A	
	900/42	
	900/55	

270x120x45 mm - 1,1 kg

900AS/C17-MBM

10 chiavi a bussola poligonali e 7 accessori per manutenzioni aeronautiche

14"



900AS/C17-MBM € 272,00 1 009000982

	900AS/MB	3/16 - 7/32 - 1/4 - 9/32 - 5/16 11/32 - 3/8 - 7/16 - 1/2 - 9/16
	900/20	50 mm
	900/21	150 mm
	900/25	
	900BG/30	
	900M/35	
	900/42	
	900M/55	

270x120x45 mm - 1,2 kg

900/C11HR

11 chiavi a bussola esagonali, 20 inserti per avvitatori e 7 accessori in termoformato rigido, in cassetta di lamiera

• cricchetto con impugnatura rotante

14"

14"



900/C11HR € 255,00 1 009000980

	861LP	0,5x3-0,8x5,5-1x5,5-1,2x6,5 mm
	861PH	PH0-PH1-PH2-PH3
	861PE	3-4-5-6-8 mm
	861TX	T8-T10-T15-T20-T25-T30-T40
	895/1	
	900	5-5,5-6-7-8-9-10-11-12-13-14 mm
	900/16	□ 1/4 - ■ 3/8
	900/20	50 mm
	900/21	150 mm
	900/25	
	900/42	
	900BG/30	
	900/58	

350x150x50 mm - 1,3 kg

902R/C6

6 raccordi per chiavi a bussola



902R/C6 € 112,50 1 009020814

	900/16	□ 1/4 - ■ 3/8
	910/15	□ 3/8 - ■ 1/4
	910/16	□ 3/8 - ■ 1/2
	920/15	□ 1/2 - ■ 3/8
	920/16	□ 1/2 - ■ 3/4
	928/15	□ 3/4 - ■ 1/2

170x100x35 mm - 600 g

902A/C22

22 chiavi a bussola esagonali e 6 accessori in cassetta di lamiera

14"

12"



902A/C22 € 369,00 1 009020807

	900	5-5,5-6-7-8-9-10-11-12-13 mm
	900/20	50 mm
	900/25	
	14" 900/55	
	920A	10-13-14-15-17-18-19 22-24-27-30-32 mm
	920/21	125 mm
	920/25	
	12" 920/55	

420x185x60 mm - 3,5 kg

9899 902A/C22 € 13,90 1 098990133

termoformato vuoto

910A

chiavi a bussola a mano bocca esagonale



UNI/ISO 2725 DIN 3124

mm	Ø mm	L mm	Ø1 mm	€	
6	9,5	28	16,7	6,60	5 009100006
7	10,7	28	16,7	6,60	5 009100007
8	12,1	28	16,7	6,60	5 009100008
9	13,2	28	16,7	6,60	5 009100009
10	14,6	29	16,7	6,60	5 009100010
11	15,8	29	16,7	6,60	5 009100011
12	17,2	30	17,7	6,80	5 009100012
13	18,4	31	17,0	6,80	5 009100013
14	19,7	32	17,5	6,80	5 009100014
15	20,9	32	18,0	6,80	5 009100015
16	22,2	33	18,5	7,65	5 009100016
17	23,2	33	19,0	7,65	5 009100017
18	24,7	34	20,0	7,65	5 009100018
19	25,8	35	21,0	7,65	5 009100019
20	27,2	35	22,0	8,20	5 009100020
21	28,2	36	23,0	8,20	5 009100021
22	29,7	37	24,0	8,30	5 009100022



910A/SB17 € 146,50 1 009100030

6-7-8-9-10-11-12
13-14-15-16-17
18-19-20-21-22 mm

910B

chiavi a bussola a mano
bocca poligonale



UNI/ISO 2725 DIN 3124

mm	Ø mm	L mm	Ø1 mm	€	Icon	Icon
6	9,5	28	16,7	6,60	5	009100106
7	10,7	28	16,7	6,60	5	009100107
8	12,1	28	16,7	6,60	5	009100108
9	13,2	28	16,7	6,60	5	009100109
10	14,6	29	16,7	6,60	5	009100110
11	15,8	29	16,7	6,60	5	009100111
12	17,2	30	17,7	6,80	5	009100112
13	18,4	31	17,0	6,80	5	009100113
14	19,7	32	17,5	6,80	5	009100114
15	20,9	32	18,0	6,80	5	009100115
16	22,2	33	18,5	7,65	5	009100116
17	23,2	33	19,0	7,65	5	009100117
18	24,7	34	20,0	7,65	5	009100118
19	25,8	35	21,0	7,65	5	009100119
20	27,2	35	22,0	8,20	5	009100120
21	28,2	36	23,0	8,20	5	009100121
22	29,7	37	24,0	8,30	5	009100122



910B/SB17 146,50 1 009100130
6-7-8-9-10-11-12
13-14-15-16-17
18-19-20-21-22 mm

910AL

chiavi a bussola a mano lunghe
bocca esagonale



UNI/ISO 2725 DIN 3124

mm	Ø mm	L mm	Ø1 mm	€	Icon	Icon
8	12,0	55	17	13,70	3	009100158
9	13,0	55	17	13,70	3	009100159
10	14,5	55	17	13,70	3	009100160
11	16,0	55	17	13,70	3	009100161
12	17,0	55	17	13,70	3	009100162
13	18,0	55	17	15,00	3	009100163
14	20,0	55	18	15,00	3	009100164
15	21,0	55	20	15,00	3	009100165
16	22,0	55	20	15,00	3	009100166
17	23,5	55	22	15,00	3	009100167
18	24,5	55	23	16,40	2	009100168
19	25,0	55	24	16,40	2	009100169
21	27,0	65	26	17,60	2	009100171
22	29,0	65	28	17,60	2	009100172



910AL/SB14 232,00 1 009100174
8-9-10-11-12-13-14
15-16-17-18-19-21-22 mm

910BL

chiavi a bussola a mano lunghe
bocca poligonale



UNI/ISO 2725 DIN 3124

mm	Ø mm	L mm	Ø1 mm	€	Icon	Icon
8	12,0	55	17	13,70	3	009100308
9	13,0	55	17	13,70	3	009100309
10	14,5	55	17	13,70	3	009100310
11	16,0	55	17	13,70	3	009100311
12	17,0	55	17	13,70	3	009100312
13	18,0	55	17	15,00	3	009100313
14	20,0	55	18	15,00	3	009100314
15	21,0	55	20	15,00	3	009100315
16	22,0	55	20	15,00	3	009100316
17	23,5	55	22	15,00	3	009100317
18	24,5	55	23	16,40	2	009100318
19	25,0	55	24	16,40	2	009100319
21	27,0	65	26	17,60	2	009100321
22	29,0	65	28	17,60	2	009100322



910BL/SB14 232,00 1 009100340
8-9-10-11-12-13
14-15-16-17-18
19-21-22 mm

910B/SN

chiavi a bussola a mano snodate
bocca poligonale



mm	Ø mm	L mm	Ø1 mm	€	Icon	Icon
10	14,5	48,5	19	35,50	2	009100230
11	15,8	49,5	19	35,50	2	009100231
12	17,0	50,0	19	35,50	2	009100232
13	18,3	51,0	19	35,50	2	009100233
14	19,5	51,0	19	39,50	2	009100234
15	20,8	53,5	19	39,50	2	009100235
16	22,0	53,5	19	39,50	2	009100236
17	23,3	54,5	19	39,50	2	009100237
18	24,5	54,5	19	39,50	2	009100238
19	25,8	56,5	19	39,50	2	009100239

910A/AS

chiavi a bussola a mano
bocca esagonale



"	Ø mm	L mm	Ø1 mm	€	Icon	Icon
1/4	10,3	26	17,3	7,75	5	009100276
5/16	11,9	26	17,3	7,75	5	009100278
11/32	13,3	26	17,3	7,75	5	009100279
3/8	13,9	26	17,3	7,75	5	009100280
7/16	15,8	26	17,3	7,75	5	009100281
1/2	17,9	26	17,3	7,95	5	009100283
9/16	19,5	27	18,5	7,95	5	009100284
19/32	20,6	27	19,5	7,95	5	009100285
5/8	21,9	28	20,0	8,55	5	009100286
11/16	24,6	30	22,5	8,55	5	009100287
3/4	25,9	30	23,5	8,55	5	009100289
13/16	27,9	32	26,0	9,60	5	009100291
7/8	29,6	32	26,5	9,90	5	009100292



910A-AS/SB13 127,50 1 009100295
1/4-5/16-11/32-3/8-7/16
1/2-9/16-19/32-5/8-11/16
3/4-13/16-7/8

910AS

chiavi a bussola a mano
bocca poligonale



"	Ø mm	L mm	Ø1 mm	€	Icon	Icon
1/4	9,5	28	16,7	7,75	5	009100201
5/16	12,1	28	16,7	7,75	5	009100202
11/32	13,2	28	16,7	7,75	5	009100203
3/8	14,6	29	16,7	7,75	5	009100204
7/16	15,8	29	16,7	7,75	5	009100205
1/2	18,4	31	17,0	7,95	5	009100206
9/16	19,7	32	17,5	7,95	5	009100207
19/32	20,9	32	18,0	7,95	5	009100208
5/8	22,2	33	18,5	8,55	5	009100209
11/16	24,7	34	20,0	8,55	5	009100210
3/4	25,8	35	21,0	8,55	5	009100211
13/16	28,2	36	23,0	9,60	5	009100212
7/8	29,7	37	24,0	9,90	5	009100213



910AS/SB13 127,50 1 009100215
1/4-5/16-11/32-3/8-7/16
1/2-9/16-19/32-5/8-11/16
3/4-13/16-7/8

910AS/L

chiavi a bussola a mano lunghe
bocca poligonale

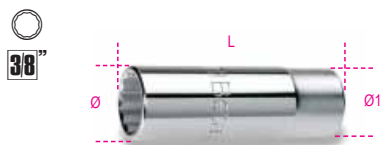

Ø	L	Ø1	€		
mm	mm	mm			
1/4	10	55	17,30	3	009100350
5/16	12	55	17,30	3	009100351
3/8	14	55	17,30	3	009100352
7/16	16	55	17,30	3	009100353
1/2	18	55	19,20	3	009100354
9/16	20	55	19,20	3	009100355
19/32	21	55	19,70	3	009100356
5/8	22	55	19,70	3	009100357
11/16	23	55	19,70	3	009100359
3/4	25	55	21,00	3	009100360
13/16	27	65	24,40	3	009100362
7/8	29	65	24,40	3	009100363



910ASL/SB12 € 255,00 1 009100365
1/4-5/16-3/8-7/16
1/2-9/16-19/32-5/8-11/16
3/4-13/16-7/8

910AS/SN

chiavi a bussola a mano snodate
bocca poligonale



* SAE AS 954E

Ø	L	Ø1	€		
mm	mm	mm			
* 3/8	14,0	48,0	39,00	2	009100260
* 7/16	15,8	51,0	39,00	2	009100261
* 1/2	18,3	51,0	39,00	2	009100262
* 9/16	19,5	51,0	39,50	2	009100263
* 5/8	22,0	53,5	39,50	2	009100264
11/16	24,5	54,5	42,00	2	009100265
3/4	25,8	56,5	42,00	2	009100266



910FTX

chiavi a bussola a mano per viti
con testa a profilo Torx®

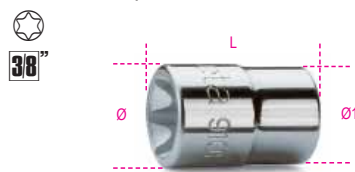

Ø	L	Ø1	€		
mm	mm	mm			
E4	6,2	26	17,3	5	009100404
E5	7,0	26	17,3	5	009100405
E6	8,3	26	17,3	5	009100406
E7	8,9	26	17,3	5	009100407
E8	9,9	26	17,3	5	009100408
E10	12,0	26	17,3	5	009100410
E11	13,3	26	17,3	5	009100411
E12	14,5	26	17,3	5	009100412
E14	15,8	26	17,3	5	009100414
E16	18,0	26	17,3	5	009100416
E18	19,5	26	18,5	3	009100418
E20	21,9	26	20,0	3	009100420



910FTX/SB9 € 97,00 1 009100430
E4-E5-E6-E7-E8
E10-E12-14-E16

910FTX/L

chiavi a bussola a mano lunghe per viti
con testa a profilo Torx®



Ø	L	Ø1	€		
mm	mm	mm			
E4	6,2	55	20,70	3	009100440
E5	7,0	55	20,70	3	009100441
E6	8,3	55	20,70	3	009100442
E7	8,9	55	20,70	3	009100443
E8	9,9	55	20,70	3	009100444
E10	12,0	55	20,70	3	009100445



910FTX-L/SB6 € 135,00 1 009100449
E4-E5-E6
E7-E8-E10

910FTX/XL

chiavi a bussola a mano extra-lunghe per viti
con testa a profilo Torx®

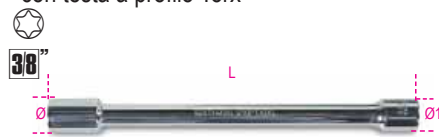

Ø	L	Ø1	€		
mm	mm	mm			
E6	8,0	200	18,60	2	009100766
E7	8,0	200	18,60	2	009100767
E8	10,0	200	18,60	2	009100768
E10	14,0	200	18,60	2	009100770
E11	14,0	200	18,60	2	009100771
E12	14,0	200	18,60	2	009100772

Ø	L	Ø1	€		
mm	mm	mm			
E14	17,0	200	20,30	2	009100774
E16	18,6	200	20,30	2	009100776
E18	21,5	200	21,50	2	009100778
E20	21,5	200	21,50	2	009100780

910FTX-XL/C10

10 chiavi a
bussola per viti con impronta Torx®
tipo lungo
in cassetta di plastica



910FTX/XL-C10 € 195,00 1 009100976
E6-E7-E8-E10-E11-
E12-E14-E16-E18-E20

255x195x62 mm - 2,3 kg

910LP

chiavi a bussola a giravite
per viti con intaglio



SxA	Ø	L	L1	€		
mm	mm	mm	mm			
1x5,5	18,5	54	24	16,20	2	009100452
1,2x6,5	18,5	54	24	16,20	2	009100453
1,2x8	18,5	54	24	16,20	2	009100454
1,6x9	18,5	54	24	16,20	2	009100456

910PH

chiavi a bussola a giravite
per viti con impronta a croce Phillips®



PH	Ø	L	L1	€		
	mm	mm	mm			
1	18,5	48	18	15,10	2	009100471
2	18,5	48	18	15,10	2	009100472
3	18,5	48	18	15,10	2	009100473
4	18,5	48	18	15,10	2	009100474



910PH/SB4 € 69,00 1 009100478
PH1-PH2-PH3-PH4

910PE

chiavi a bussola maschio esagonale



DIN 7422

mm	Ø mm	L mm	L1 mm	€	Icon	Icon
3	18,5	50	20	13,20	5	009100490
4	18,5	50	20	13,20	5	009100492
5	18,5	50	20	13,20	5	009100494
6	18,5	50	20	13,20	5	009100496
7	18,5	50	20	13,20	5	009100497
8	18,5	50	20	13,20	5	009100498
9	18,5	50	20	13,20	5	009100499
10	18,5	50	20	13,20	5	009100500



910PE/SB7
3-4-5-6-7-8-10 mm € 104,50 1 009100503

910BP

chiavi a bussola maschio esagonale con estremità sferica



mm	L mm	L1 mm	€	Icon	Icon
4L	92	62	15,70	3	009100584
5L	92	62	15,70	3	009100585
6L	92	62	15,70	3	009100586
7L	92	62	15,70	3	009100587
8L	92	62	15,70	3	009100588
10L	132	102	17,00	3	009100590



910BP/SB6L
4L-5L-6L-7L-8L-10L mm € 106,50 1 009100596

910ME

chiavi a bussola maschio esagonale



mm	Ø mm	L mm	L1 mm	€	Icon	Icon
4	18	62	15	15,80	5	009100504
5	18	62	15	15,80	5	009100505
6	18	62	15	15,80	5	009100506
7	18	62	15	16,10	5	009100507
8	19	62	15	16,10	5	009100508
10	20	62	15	16,10	5	009100510
12	20	62	15	16,10	5	009100512

3/8"



910ME/SB5
4-5-6-8-10 mm € 89,50 1 009100515

910PE/AS

chiavi a bussola maschio esagonale



"	Ø mm	L mm	L1 mm	€	Icon	Icon
1/8	18,5	50	20	22,60	2	009100531
5/32	18,5	50	20	22,60	2	009100532
3/16	18,5	50	20	22,60	2	009100533
7/32	18,5	50	20	22,60	2	009100534
1/4	18,5	50	20	22,60	2	009100535
5/16	18,5	50	20	22,60	2	009100536
3/8	18,5	50	20	25,00	2	009100537

910PT

chiavi a bussola a giravite per viti con impronta pentalobata



"	Ø mm	L mm	L1 mm	€	Icon	Icon
PT40	20	50	20	21,00	3	009100540
PT45	20	50	20	21,50	3	009100545
PT50	20	50	20	25,50	3	009100550

3/4"



910PT/SB8
PT10-PT15-PT20-PT25
PT30-PT40-PT45-PT50 € 173,00 1 009100558

910TX

chiavi a bussola maschio per viti con impronta Torx®



"	Ø mm	L mm	L1 mm	€	Icon	Icon
T15	18,5	50	20	17,30	5	009100519
T20	18,5	50	20	17,30	5	009100520
T25	18,5	50	20	17,30	5	009100521
T27	18,5	50	20	17,30	5	009100522
T30	18,5	50	20	17,30	5	009100523
T40	18,5	50	20	17,30	5	009100524
T45	18,5	50	20	17,30	3	009100525
T50	18,5	50	20	17,30	3	009100526

3/8"



910TX/SB6
T15-T20-T25
T27-T30-T40 € 114,50 1 009100530

910XZN

chiavi a bussola maschio a profilo XZN®



"	L mm	€	Icon	Icon
M4	50	18,60	3	009100559
M5	50	18,60	3	009100560
M6	50	18,60	3	009100561
M8	50	18,60	3	009100563
M10	50	19,70	3	009100565

910CF

chiavi a zampa di gallo



mm	A mm	L mm	€	Icon	Icon
10	21,3	32,3	11,20	2	009100135
11	23,1	34,3	11,20	2	009100136
12	25,5	36,2	12,60	2	009100137
13	26,9	37,4	12,60	2	009100138
14	30,2	40,0	13,40	2	009100139
15	33,3	41,3	14,00	2	009100140
16	33,3	41,3	15,20	2	009100141
17	38,1	46,5	17,60	2	009100142
18	38,1	46,5	17,60	2	009100143
19	39,6	48,0	19,20	2	009100144

3/8"



910CF/SB10
10-11-12-13-14-15
16-17-18-19 mm € 160,50 1 009100147

910/15

raccordo con attacco quadro femmina 3/8" e maschio 1/4"



UNI/ISO 3316 DIN 3123

L mm	Ø mm	Icon	Icon	€	Icon	Icon
30	17,0	3/8	1/4	9,70	5	009100810



E' assolutamente necessario commisurare la coppia di serraggio alla capacità del quadro maschio per evitare rotture o danni accidentali

910/16

raccordo con attacco quadro femmina 3/8" e maschio 1/2"



UNI/ISO 3316 DIN 3123

L	Ø		€		
mm	mm				
32	18,0	3/8	10,10	5	009100814

910/20 - 910/21 - 910/22

prolunghe con attacchi quadri maschio e femmina 3/8"

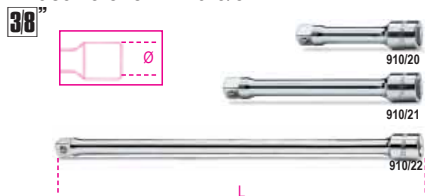

UNI/ISO 3316 DIN 3123

	L	Ø	€		
	mm	mm			
910/20	75	17	8,30	5	009100820
910/21	125	17	12,00	5	009100822
910/22	250	17	15,80	5	009100826

910AN

prolunghe con attacchi quadri maschio e femmina 3/8" angolari

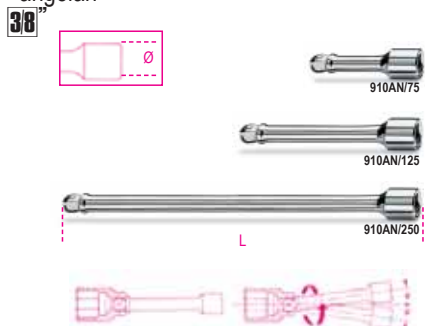

	L	Ø	€		
	mm	mm			
910AN/75	75	17	11,80	3	009100827
910AN/125	125	17	14,70	3	009100828
910AN/250	250	17	22,00	3	009100829

910/25

snodo con attacchi quadri maschio e femmina 3/8"



UNI/ISO 3316 DIN 3123

L	Ø	€		
mm	mm			
54,6	19	21,70	5	009100830

910M/35

quadro maschio 3/8" snodato con impugnatura in metallo



UNI/ISO 3315 DIN 3122

L	€		
mm			
250	60,00	3	009100839

910/36A

quadro maschio 3/8" snodato con impugnatura



UNI/ISO 3315 DIN 3122

L	L1	€		
mm	mm			
255	154	42,00	3	009100845

910/40

quadro maschio 3/8" snodato a T

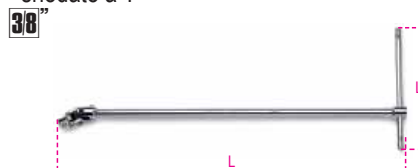

L	L1	€		
mm	mm			
420	175	45,00	3	009100850

910/42

quadro maschio 3/8" con spina scorrevole

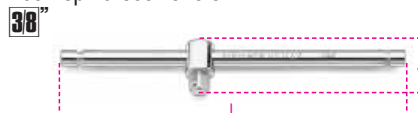

UNI/ISO 3315 DIN 3122

L	A	€		
mm	mm			
210	30,5	14,30	5	009100854

910/46

quadro maschio 3/8" con manovella

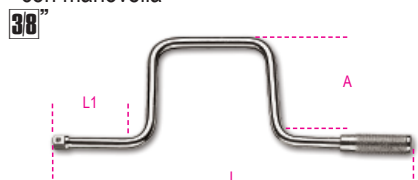

UNI/ISO 3315 DIN 3122

L	L1	A	€		
mm	mm	mm			
315	80	115	28,00	1	009100862

910/55

cricchetto reversibile con attacco quadro maschio 3/8" meccanismo a 72 denti



UNI/ISO 3315 DIN 3122

L	Ø	A	€		
mm	mm	mm			
200	30	33	51,00	3	009100882

910/550

cricchetto reversibile con attacco quadro maschio 3/8" meccanismo a 48 denti



UNI/ISO 3315 DIN 3122

L	Ø	A	€		
mm	mm	mm			
200	30	33	51,00	3	009100885

Meccanismi rotanti di ricambio dei cricchetti, vedi tabella dopo l'art. 929/C8

910M/55

cricchetto reversibile con attacco quadro maschio 3/8" con impugnatura in metallo



DIN 3122 - UNI ISO 3315

L	Ø	A	€		
mm	mm	mm			
178	30	26	70,00	2	009100875



910M/56

cricchetto reversibile snodato
con attacco quadro maschio 3/8"
con impugnatura in metallo



L mm	Ø mm	A mm	€	1	009100887
265	31	29	95,50	2	009100887

910/58

cricchetto reversibile
con impugnatura rotante
con attacco quadro maschio 3/8"
meccanismo a 52 denti

- Pulsante di rilascio della bussola
- Sistema di inversione a ghiera sulla testa del cricchetto
- Impugnatura bimeriale



L mm	Ø mm	A mm	€	1	009100884
222	37	38,5	78,50	1	009100884

910.../C10

10 chiavi a bussola esagonali
e 2 accessori



910A/C10	€	1	009100909
	166,00	1	009100909

910A	6 - 7 - 8 - 10 - 11 - 12 13 - 14 - 17 - 19 mm
910/21	125 mm
910/55	

270x120x45 mm - 1,3 kg

910B/C10	€	1	009100910
	166,00	1	009100910

910B	6 - 7 - 8 - 10 - 11 - 12 13 - 14 - 17 - 19 mm
910/21	125 mm
910/55	

270x120x45 mm - 1,3 kg

910A/C16...

16 chiavi a bussola esagonali
e 5 accessori



910A/C16	€	1	009100936
	269,00	1	009100936

910A	6 - 7 - 8 - 9 - 10 - 11 - 12 - 13 14 - 15 - 16 - 17 - 18 - 19 21 - 22 mm
910/21	125 mm
910/22	250 mm
910/25	
910/42	
910/55	

335x145x60 mm - 2,3 kg

9899 910C16	€	1	098990134
	13,90	1	098990134

termoformato vuoto

910A/C16Q	€	1	009100932
	269,00	1	009100932

910A	6 - 7 - 8 - 9 - 10 - 11 - 12 - 13 14 - 15 - 16 - 17 - 18 - 19 21 - 22 mm
910/21	125 mm
910/22	250 mm
910/25	
910/42	
910/55Q	

335x145x60 mm - 2,3 kg

9899 910C16	€	1	098990134
	13,90	1	098990134

termoformato vuoto

910B/C16...

16 chiavi a bussola poligonali
e 5 accessori



910B/C16	€	1	009100937
	269,00	1	009100937

910B	6 - 7 - 8 - 9 - 10 - 11 - 12 - 13 14 - 15 - 16 - 17 - 18 - 19 21 - 22 mm
910/21	125 mm
910/22	250 mm
910/25	
910/42	
910/55	

335x145x60 mm - 2,3 kg

9899 910C16	€	1	098990134
	13,90	1	098990134

termoformato vuoto

910B/C16Q	€	1	009100933
	269,00	1	009100933

910B	6 - 7 - 8 - 9 - 10 - 11 - 12 - 13 14 - 15 - 16 - 17 - 18 - 19 21 - 22 mm
910/21	125 mm
910/22	250 mm
910/25	
910/42	
910/55Q	

335x145x60 mm - 2,3 kg

9899 910C16	€	1	098990134
	13,90	1	098990134

termoformato vuoto

910A/C17

17 chiavi a bussola esagonali
e 9 accessori



910A/C17	€	1	009100938
	401,00	1	009100938

910A	6 - 7 - 8 - 9 - 10 - 11 - 12 - 13 14 - 15 - 16 - 17 - 18 - 19 - 20 21 - 22 mm
910/15	□ 3/8 - ■ 1/4
910/16	□ 3/8 - ■ 1/2
910/21	125 mm
910/22	250 mm
910/25	
910/36A	
910/42	
910/46	
910/55	

420x280x60 mm - 4,0 kg



910.../C29

17 chiavi a bussola
12 a giravite e 5 accessori

38"



910A/C29 € 459,00 1 009100944

	○ 910A	6 - 7 - 8 - 9 - 10 - 11 - 12 - 13 14 - 15 - 16 - 17 - 18 - 19 - 20 21 - 22 mm
	● 910LP	1x5,5 - 1,2x6,5 - 1,2x8 mm
	⊕ 910PH	PH1 - PH2 - PH3
	○ 910PE	3 - 4 - 5 - 6 - 8 - 10 mm
	910/21	125 mm
	910/22	250 mm
	910/25	
	910/42	
	910/55	

420x185x60 mm - 3,5 kg

910B/C29 € 459,00 1 009100945

	○ 910B	6 - 7 - 8 - 9 - 10 - 11 - 12 - 13 14 - 15 - 16 - 17 - 18 - 19 - 20 21 - 22 mm
	● 910LP	1x5,5 - 1,2x6,5 - 1,2x8 mm
	⊕ 910PH	PH1 - PH2 - PH3
	○ 910PE	3 - 4 - 5 - 6 - 8 - 10 mm
	910/21	125 mm
	910/22	250 mm
	910/25	
	910/42	
	910/55	

420x185x60 mm - 3,5 kg

910AS/C13...

13 chiavi a bussola poligonali
e 5 accessori

38"



910AS/C13 € 270,00 1 009100925

	○ 910AS	1/4 - 5/16 - 11/32 - 3/8 - 7/16 1/2 - 9/16 - 19/32 - 5/8 - 11/16 3/4 - 13/16 - 7/8
	910/21	125 mm
	910/22	250 mm
	910/42	
	910/25	
	910/55	

335x145x60 mm - 2,3 kg

910AS/MBM-C18

13 chiavi a bussola poligonali
e 5 accessori
per manutenzioni aeronautiche

38"



910AS/MBM-C18 € 282,00 1 009100926

	○ 910AS	1/4 - 5/16 - 11/32 - 3/8 - 7/16 1/2 - 9/16 - 19/32 - 5/8 - 11/16 3/4 - 13/16 - 7/8
	910/21	125 mm
	910/22	250 mm
	910/25	
	910/42	
	910M/55	

335x145x60 mm - 2,5 kg

910A/C16HR

16 chiavi a bussola
esagonali e 5 accessori

• cricchetto con impugnatura rotante

38"



910A/C16HR € 296,00 1 009100935

	○ 910A	6 - 7 - 8 - 9 - 10 - 11 - 12 - 13 14 - 15 - 16 - 17 - 18 - 19 21 - 22 mm
	910/21	125 mm
	910/22	250 mm
	910/25	
	910/42	210 mm
	910/58	

335x145x60 mm - 2,4 kg



920A

chiavi a bussola a mano
bocca esagonale

12"



UNI/ISO 2725 DIN 3124

mm	Ø mm	L mm	Ø1 mm	€	
8	12,4	38	21,7	6,65	10 009200008
9	13,5	38	21,7	6,65	10 009200009
10	14,9	38	21,7	6,65	10 009200010
11	16,1	38	21,7	6,65	10 009200011
12	17,5	38	21,7	6,65	10 009200012
13	18,7	38	21,7	6,90	10 009200013
14	20,1	38	21,7	6,90	10 009200014
15	21,5	38	22,5	6,90	10 009200015
16	22,7	38	23,7	7,75	10 009200016
17	24,1	38	23,1	7,75	10 009200017
18	25,3	39	24,0	7,75	10 009200018
19	26,6	39	24,0	7,75	10 009200019
20	27,8	40	25,0	8,45	5 009200020
21	28,8	40	25,0	8,45	5 009200021
22	29,9	41	26,0	8,45	5 009200022
23	30,8	42	26,0	9,90	5 009200023
24	32,2	43	27,0	9,90	5 009200024
25	33,2	44	27,0	9,90	5 009200025
26	34,7	45	28,0	10,20	5 009200026
27	36,2	46	29,0	10,20	5 009200027
28	37,2	47	30,0	10,20	5 009200028
29	38,6	48	31,0	10,70	5 009200029
30	40,2	48	32,0	10,70	5 009200030
32	42,3	49	34,0	11,20	5 009200032

12"



920A/SB13 € 116,50 1 009200040
10-11-12-13-14-15-16
17-18-19-20-21-22 mm

12"



920A/SB8 € 95,50 1 009200042
23-24-25-26-27-28-30-32 mm

920MC

chiavi a bussola a mano
bocca esagonale
colorate

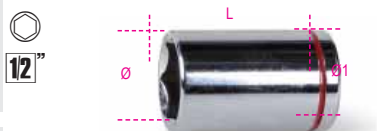

mm	Ø	L	Ø1	€	Icon	Icon
8	13,2	38	22	7,30	5	009202008
10	15,3	38	22	7,30	5	009202010
11	16,5	38	22	7,30	5	009202011
12	17,8	38	22	7,30	5	009202012
13	19,0	38	22	7,55	5	009202013
14	20,3	38	22	7,55	5	009202014
15	21,6	38	22	7,55	5	009202015
16	23,0	38	23	8,45	5	009202016
17	23,9	38	24	8,45	5	009202017
18	25,0	38	25	8,45	5	009202018
19	26,5	38	24	8,45	5	009202019
21	28,8	38	27	9,30	3	009202021
22	29,9	40	28	9,30	3	009202022
24	32,8	40	30	10,80	3	009202024

920B

chiavi a bussola a mano
bocca poligonale



UNI/ISO 2725 DIN 3124

mm	Ø	L	Ø1	€	Icon	Icon
8	12,4	38	21,7	6,65	10	009200108
9	13,5	38	21,7	6,65	10	009200109
10	14,9	38	21,7	6,65	10	009200110
11	16,1	38	21,7	6,65	10	009200111
12	17,5	38	21,7	6,65	10	009200112
13	18,7	38	21,7	6,90	10	009200113
14	20,1	38	21,7	6,90	10	009200114
15	21,5	38	22,5	6,90	10	009200115
16	22,7	38	23,7	7,75	10	009200116
17	24,1	38	23,1	7,75	10	009200117
18	25,3	39	24,0	7,75	10	009200118
19	26,6	39	24,0	7,75	10	009200119
20	27,8	40	25,0	8,45	5	009200120
21	28,8	40	25,0	8,45	5	009200121
22	29,9	41	26,0	8,45	5	009200122
23	30,8	42	26,0	9,90	5	009200123
24	32,2	43	27,0	9,90	5	009200124
25	33,2	44	27,0	9,90	5	009200125
26	34,7	45	28,0	10,20	5	009200126
27	36,2	46	29,0	10,20	5	009200127
28	37,2	47	30,0	10,20	5	009200128
29	38,6	48	31,0	10,70	5	009200129
30	40,2	48	32,0	10,70	5	009200130
32	42,3	49	33,9	11,20	5	009200132



920B/SB13 116,50 1 009200140
10-11-12-13-14-15-16
17-18-19-20-21-22 mm



920B/SB8 95,50 1 009200142
23-24-25-26-27
28-30-32 mm

920AL

chiavi a bussola a mano lunghe
bocca esagonale



UNI/ISO 2725 DIN 3124

mm	Ø	L	Ø1	€	Icon	Icon
10	14,7	77	21	17,70	5	009200626
12	17,8	77	21	17,70	5	009200627
13	19,0	77	22	17,70	5	009200628
14	20,3	77	22	17,70	5	009200629
15	21,5	77	22	17,70	5	009200630
16	22,8	77	22	19,00	5	009200631
17	24,0	77	23	19,00	5	009200632
18	25,0	77	24	20,00	5	009200633
19	26,5	77	25	20,00	5	009200634
21	29,0	77	27	22,20	5	009200635
22	30,0	77	28	22,20	5	009200636
23	31,5	77	29	22,20	5	009200637
24	32,8	77	30	25,50	5	009200638
27	36,5	77	33	26,50	3	009200639
30	40,0	77	36	32,00	3	009200640
32	42,8	77	38	32,50	3	009200641
36	48,0	77	41	52,50	3	009200642



920AL/SB11 228,00 1 009200644
10-12-13-14-15-16
17-18-19-21-22 mm

920BL

chiavi a bussola a mano lunghe
bocca poligonale



UNI/ISO 2725 DIN 3124

mm	Ø	L	Ø1	€	Icon	Icon
10	14,7	77	21	17,70	5	009200310
12	17,8	77	21	17,70	5	009200312
13	19,0	77	22	17,70	5	009200313
14	20,3	77	22	17,70	5	009200314
15	21,5	77	22	17,70	5	009200315
16	22,8	77	22	19,00	5	009200316
17	24,0	77	23	19,00	5	009200317
18	25,0	77	24	20,00	5	009200318
19	26,5	77	25	20,00	5	009200319
21	29,0	77	27	22,20	5	009200321
22	30,0	77	28	22,20	5	009200322
23	31,5	77	29	22,20	5	009200323
24	32,8	77	30	25,50	5	009200324
27	36,5	77	33	26,50	3	009200327
30	40,0	77	36	32,00	3	009200330
32	42,8	77	38	32,50	3	009200332
36	48,0	77	41	52,50	3	009200336



920BL/SB11 228,00 1 009200338
10-12-13-14-15-16-17-18
19-21-22 mm

920A/AS

chiavi a bussola a mano
bocca esagonale



mm	Ø	L	Ø1	€	Icon	Icon
3/8	14,6	37	21	7,80	2	009200270
7/16	16,5	37	21	7,80	3	009200272
1/2	19,0	37	22	8,10	3	009200273
9/16	20,3	37	22	8,10	3	009200274
19/32	21,0	37	22	8,65	3	009200275
5/8	22,8	37	22	8,65	3	009200276
11/16	25,0	37	24	8,95	3	009200277
3/4	26,5	38	25	8,95	3	009200279
25/32	28,0	38	26	10,10	3	009200280
13/16	29,0	38	27	10,10	3	009200281
7/8	30,0	40	28	10,10	3	009200282
15/16	32,8	42	30	10,70	3	009200284
1	35,0	42	32	10,70	3	009200285
1.1/16	36,5	43	33	11,80	2	009200287
1.1/8	39,0	43	35	12,10	2	009200289
1.3/16	41,0	46	36	13,00	2	009200290
1.1/4	42,8	46	38	13,20	2	009200292



920A-AS/SB11 117,00 1 009200295
3/8-7/16-1/2-9/16-5/8
11/16-3/4-13/16-7/8
15/16-1

920AS

chiavi a bussola a mano
bocca poligonale



mm	Ø	L	Ø1	€	Icon	Icon
3/8	14,9	38	21,7	7,80	3	009200201
7/16	16,1	38	21,7	7,80	3	009200202
1/2	18,7	38	21,7	8,10	3	009200203
9/16	20,1	38	21,7	8,10	3	009200204
5/8	22,7	38	22,5	8,65	3	009200206
19/32	21,5	38	23,7	8,65	3	009200207
11/16	25,3	39	24,0	8,95	3	009200208
3/4	26,6	39	24,0	8,95	3	009200209
25/32	27,8	40	25,0	10,10	3	009200210
13/16	28,8	40	25,0	10,10	3	009200211
7/8	29,9	41	26,0	10,10	3	009200212
15/16	32,2	43	27,0	10,70	3	009200214
1	34,2	45	28,0	10,70	3	009200216
1.1/16	36,2	46	29,0	11,80	2	009200217
1.1/8	38,6	48	31,0	12,10	2	009200218
1.3/16	40,2	48	32,0	13,00	2	009200219
1.1/4	42,3	49	33,5	13,20	2	009200220



920AS/SB11 117,00 1 009200225
3/8-7/16-1/2-9/16-5/8
11/16-3/4-13/16-7/8
15/16-1

920AS/L

chiavi a bussola a mano lunghe
bocca poligonale



"	Ø mm	L mm	Ø1 mm	€		
1/2	19,0	77	22	24,40	2	009200352
9/16	20,3	77	22	24,40	2	009200353
5/8	22,8	77	22	24,40	2	009200355
11/16	25,0	77	24	26,00	2	009200357
3/4	26,5	77	25	26,50	2	009200358
13/16	29,0	77	27	31,50	2	009200360
7/8	30,0	77	28	31,50	2	009200361
15/16	32,8	77	30	32,50	2	009200362
1	35,0	77	32	33,50	2	009200363
1.1/16	36,5	77	33,0	36,50	2	009200364
1.1/8	37,8	77	34	37,50	2	009200365



920ASL/SB11 € 346,00 1 009200369
1/2-9/16-5/8-11/16
3/4-13/16-7/8-15/16
1-1.1/8-1.1/16

920U

chiavi a bussola a mano
bocca multimpronta



mm	"	Ø	M	L mm	€		
10	3/8	E12	M12	38	7,00	5	009201710
11	7/16	E14	M14	38	7,00	5	009201711
12	15/32	E16		38	7,00	5	009201712
13	1/2		M16	38	7,30	5	009201713
14	9/16	E18	M18	38	7,30	5	009201714
15	19/32			38	7,30	5	009201715
16	5/8	E20		38	8,15	5	009201716
17				38	8,15	5	009201717
18		E22		38	8,15	5	009201718
19	3/4	E24		38	8,15	5	009201719
20	25/32			38	8,95	3	009201720
21				38	8,95	3	009201721
22	7/8			38	8,95	3	009201722
24	15/16			38	10,40	3	009201724
27	1.1/16			42	10,70	3	009201727
30	1.1/8			44	11,40	3	009201730
32	1.1/4			44	11,90	3	009201732



920U/SB13 € 122,00 1 009201740
10-11-12-13-14-15-16
17-18-19-20-21-22 mm



920U/SB4 € 53,00 1 009201744
24-27-30-32 mm

920FTX

chiavi a bussola a mano per viticon testa a
profilo Torx®



"	Ø mm	L mm	Ø1 mm	€		
E10	13,2	36	21	10,70	5	009200380
E12	15,0	37	21	10,70	5	009200381
E14	16,3	37	21	10,70	5	009200382
E16	18,8	37	22	10,70	5	009200383
E18	20,4	37	22	10,70	5	009200384
E20	22,9	37	22	11,70	5	009200385
E22	25,0	37	24	13,50	3	009200387
E24	26,5	40	25	15,30	3	009200388



920FTX/SB6 € 76,00 1 009200390
E10-E12-E14
E16-E18-E20



920FTX/C8 € 128,50 1 009200391
E10-E12-E14-E16
E18-E20-E22-E24

270X120X45 mm - 1 kg

920FTX/L

chiavi a bussola a mano lunghe
per viti con testa a profilo Torx®



"	Ø mm	L mm	Ø1 mm	€		
E10	13,2	77	21,0	22,50	5	009200400
E12	15,0	77	21,0	22,50	5	009200401
E14	16,3	77	21,0	22,50	5	009200402
E16	18,8	77	21,8	22,50	3	009200403
E18	20,4	77	21,8	22,50	3	009200404
E20	22,9	77	22,0	22,50	3	009200405



920FTX-LSB6 € 146,00 1 009200409
E10-E12-E14
E16-E18-E20

920LP

chiavi a bussola a giravite
per viti con intaglio

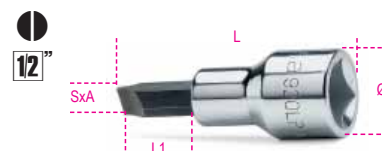

SxA mm	Ø mm	L mm	L1 mm	€		
1x5,5	22,5	62	24	17,50	3	009200452
1,2x6,5	22,5	62	24	17,50	3	009200453
1,2x8	22,5	62	24	17,50	3	009200454
1,6x9	22,5	62	24	17,50	3	009200456
2x12	22,5	62	24	17,50	3	009200458

920PH

chiavi a bussola a giravite
per viti con impronta a croce Phillips®



PH	Ø mm	L mm	L1 mm	€		
1	22,5	56	18	15,40	3	009200471
2	22,5	56	18	15,40	3	009200472
3	22,5	56	18	15,40	3	009200473
4	22,5	56	18	15,40	3	009200474



920PH/SB4 € 70,00 1 009200479
PH1-PH2-PH3-PH4

920LH/SB7

chiavi a bussola a giravite
per viti con impronta a croce Phillips®



920LH/SB7 € 128,00 1 009200478
920LP 1,2x6,5 - 1,2x8
1,6x9 - 2x12 mm
920PH PH2 - PH3 - PH4

920PE

chiavi a bussola
maschio esagonale

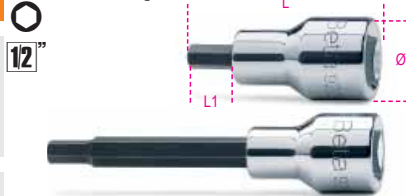

DIN 7422

mm	Ø mm	L mm	L1 mm	€	🔧	📦
3	22,5	58	20	14,00	5	009200410
4	22,5	58	20	14,00	5	009200412
5	22,5	58	20	14,00	5	009200414
5L	22,5	100	62	15,30	5	009200415
6	22,5	58	20	14,00	5	009200417
6L	22,5	100	62	15,30	5	009200418
7	22,5	58	20	14,00	5	009200420
7L	22,5	100	62	15,30	5	009200421
8	22,5	58	20	14,00	5	009200423
8L	22,5	100	62	15,30	5	009200424
9	22,5	58	20	14,00	5	009200425
9L	22,5	140	102	16,10	5	009200426
10	22,5	58	20	14,00	5	009200428
10L	22,5	140	102	16,10	5	009200429
12	23,0	58	20	16,30	5	009200432
12L	22,5	140	102	18,60	5	009200433
14	23,0	58	20	16,30	5	009200434
14L	22,5	140	102	18,60	5	009200435
17	29,5	60	22	19,90	5	009200437
19	29,5	60	22	19,90	5	009200439



920PE/SB9
4-5-6-8-10 mm
5L-6L-8L-10L mm

€ 146,50 1 009200441



920PE/C10
4-5-6-7-8-10
12-14-17-19 mm

€ 191,00 1 009200443

270X120X45 mm - 1,5 kg

9899 920PE/C10
termoformato vuoto

€ 13,90 1 098990135

920PE/AS
chiavi a bussola
maschio esagonale



"	Ø mm	L mm	L1 mm	€	🔧	📦
1/8	22,5	58	20	16,40	2	009200460
3/16	22,5	58	20	16,40	2	009200461
1/4	22,5	58	20	16,40	2	009200463
3/8	22,5	58	20	16,40	2	009200464
1/2	22,5	60	20	17,90	2	009200465
3/4	22,5	60	20	19,20	1	009200468



920PE-AS/SB6
1/8-3/16-1/4-3/8-1/2-3/4

€ 113,50 1 009200469

920BP

chiavi a bussola maschio esagonale
con estremità sferica

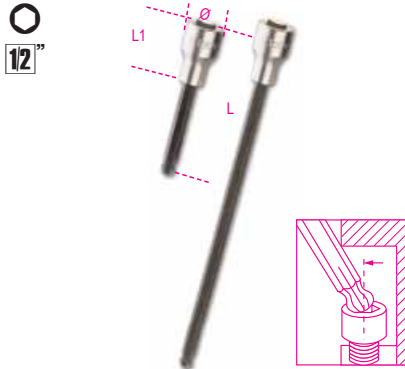

mm	Ø mm	L mm	L1 mm	€	🔧	📦
5L	22,5	100	62	17,60	5	009200490
5XL	22,5	240	202	22,60	1	009200495
6L	22,5	100	62	17,60	5	009200491
6XL	22,5	240	202	22,60	1	009200496
7L	22,5	100	62	17,60	5	009200492
8L	22,5	100	62	17,60	5	009200493
8XL	22,5	240	202	22,60	1	009200497
10L	22,5	140	102	19,20	5	009200494



920BP/SB8
5L-6L-7L-8L-10L mm
5XL-6XL-8XL mm

€ 171,00 1 009200500

920ME

chiavi a bussola
maschio esagonale



mm	Ø mm	L mm	L1 mm	€	🔧	📦
5	21	75	15,5	16,40	5	009200505
6	21	75	15,5	16,40	5	009200506
7	21	75	15,5	16,40	5	009200507
8	21	75	15,5	16,40	5	009200508
10	23	75	15,5	17,10	5	009200510
12	24	75	15,5	19,70	5	009200512
14	24	75	15,5	20,30	5	009200514
17	24	75	15,5	20,30	5	009200517



920ME/SB7
5-6-8-10-12-14-17 mm

€ 138,50 1 009200519



920ME/C7
5-6-8-10-12-14-17 mm

€ 156,50 1 009200518

250X100X35 mm - 1,4 kg

920TX

chiavi a bussola maschio
per viti con impronta Torx®

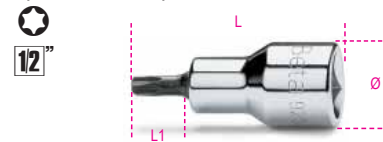

T	Ø mm	L mm	L1 mm	€	🔧	📦
T20	22,5	58	20	17,10	5	009200520
T20L	22,5	120	82	21,90	3	009200530
T25	22,5	58	20	17,10	5	009200521
T25L	22,5	120	82	21,90	3	009200531
T27	22,5	58	20	17,10	5	009200522
T27L	22,5	120	82	21,90	3	009200533
T30	22,5	58	20	17,10	5	009200523
T30L	22,5	120	82	21,90	3	009200534
T40	22,5	58	20	17,10	5	009200524
T40L	22,5	120	82	21,90	3	009200535
T45	22,5	58	20	17,10	5	009200525
T45L	22,5	120	82	21,90	3	009200537
T50	22,5	58	20	17,10	5	009200526
T50L	23,0	140	102	21,90	3	009200538
T55	23,0	58	20	22,90	3	009200527
T55L	23,0	140	102	31,00	3	009200539
T60L	23,0	58	20	22,90	3	009200528
T60L	23,0	140	102	31,00	3	009200540
T70L	23,0	120	82	31,00	3	009200541



920TX/SB9
T20-T25-T27-T30
T40-T45-T50-T55-T60

€ 180,00 1 009200532



920TX-L/SB10
T20L-T25L-T27L-T30L-T40L-
T45L-T50L-T55L-T60L-T70L

€ 262,00 1 009200545



920TX/C9
T20-T25-T27-T30-T40
T45-T50-T55-T60

€ 200,00 1 009200546

270X120X45 mm - 1,2 kg

9899 920TX/C9
termoformato vuoto

€ 13,90 1 098990136

920RTX

chiavi a bussola maschio per viti con impronta Tamper Resistant Torx®

12"



Ø	L	L1	€	5	1
T20	22,5	58	20	18,30	009200370
T25	22,5	58	20	18,30	009200371
T27	22,5	58	20	18,30	009200372
T30	22,5	58	20	18,30	009200373
T40	22,5	58	20	18,30	009200374

12"



920RTX/SB5	€	5	1
T20-T25-T27-T30-T40	101,00	009200378	

920XZN

chiavi a bussola maschio a profilo XZN®

12"

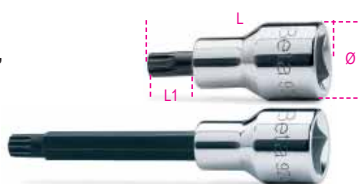

DIN 2324

Ø	L	L1	€	3	1
M4	22,5	58	20	18,40	009200559
M5	22,5	58	20	18,40	009200560
M6	22,5	58	20	18,40	009200561
M6L	22,5	100	62	21,00	009200562
M8	22,5	58	20	18,40	009200563
M8L	22,5	100	62	21,00	009200564
M9	22,5	58	20	18,40	009200582
M9L	22,5	100	62	21,00	009200583
M10	22,5	58	20	18,60	009200565
M10L	22,5	100	62	21,00	009200566
M12	22,5	58	20	19,20	009200568
M12L	22,5	100	62	21,50	009200569
M14	23,0	58	20	19,20	009200571
M14L	23,0	100	62	21,50	009200572
M16	23,0	58	20	23,90	009200573
M18	23,0	58	20	24,40	009200574

12"



920XZN/SB7	€	1
M4-M5-M6-M8-M10-M12-M14	142,50	009200579

12"



920XZN/SB12	€	1
M5-M6-M8-M10-M12-M14-M16-M6L-M8L-M10L-M12L-M14L	261,00	009200577

12"



920XZN-L/S5	€	1
M6L-M8L-M10L-M12L-M14L	106,00	009200578

920ES

chiavi a bussola per viti con impronta esascalanata

12"



UNI 9326

Ø	L	L1	€	5	1
7	(6R)	58	20	25,50	009200587
7XL	(6R)	240	202	36,00	009200607
9	(8R)	58	20	25,50	009200589
9XL	(8R)	240	202	36,00	009200609
10	(8S)	58	20	25,50	009200590
10XL	(8S)	240	202	36,00	009200610
11	(10R)	58	20	25,50	009200591
11XL	(10R)	240	202	36,00	009200611
12L	(10S)	100	62	29,00	009200592
12XL	(10S)	240	202	39,50	009200612
14L	(12S)	100	62	29,00	009200594
14XL	(12S)	240	202	39,50	009200614
16L	(14R)	100	62	29,00	009200596
16XL	(14R)	240	202	39,50	009200616

12"



920ES/SB7	€	1
7-9-10-11-12L-14L-16L	201,00	009200598

12"



920ES-XL/SB7	€	1
7XL-9XL-10XL-11XL-12XL-14XL-16XL	275,00	009200618

PM 1/2-Q5



PM 1/2-Q5	72,560
-----------	--------

920/15

raccordo con attacco quadro femmina 1/2" e maschio 3/8"

12"



UNI/ISO 3316 DIN 3123

L	Ø	€	5
42	1/2 3/8	22,0	11,00



E' assolutamente necessario commisurare la coppia di serraggio alla capacità del quadro maschio per evitare rotture o danni accidentali

920/16

raccordo con attacco quadro femmina 1/2" e maschio 3/4"

12"



UNI/ISO 3316 DIN 3123

L	Ø	€	5
46	1/2 3/4	26	14,40

920/20÷920/23

prolunghe con attacchi quadri maschio e femmina 1/2"

12"



UNI/ISO 3316 DIN 3123

	L	Ø	€	5
920/20	75	22	13,40	009200818
920/21	125	22	16,40	009200822
920/22	255	22	18,60	009200826
920/23	375	22	24,90	009200827

920AN

prolunghe con attacchi quadri maschio e femmina 1/2" angolari

12"

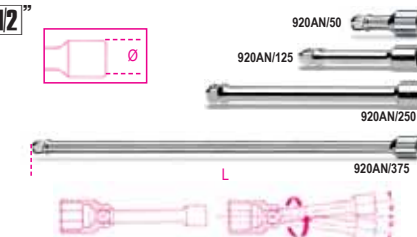

	L	Ø	€	5
920AN/50	50	22	14,40	009200833
920AN/125	125	22	19,80	009200834
920AN/250	250	22	28,00	009200835
920AN/375	375	22	37,00	009200836

920/25
snodo con attacchi quadri
maschio e femmina 1/2"



UNI/ISO 3316 DIN 3123

L mm	Ø mm	€	5	009200830
75	27	26,00		

920/35A
quadro maschio 1/2" snodato
con impugnatura



UNI/ISO 3315 DIN 3122

L mm	L1 mm	€	3	009200846
285	160	52,00		

920M/35
quadro maschio 1/2" snodato
con impugnatura in metallo



UNI/ISO 3315 DIN 3122

L mm	€	2	009200845
380	74,50		

920M/35L
quadro maschio 1/2" snodato
con impugnatura in metallo, lungo



L mm	€	1	009200843
600	112,50		



È assolutamente necessario applicare il carico di torsione adeguatamente e progressivamente per evitare rotture o danni accidentali.

920/36A
quadro maschio 1/2" snodato
con impugnatura

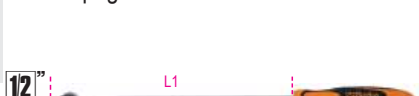

UNI/ISO 3315 DIN 3122

L mm	L1 mm	€	2	009200847
408	283	58,50		

920/38
quadro maschio estensibile 1/2" snodato
con impugnatura



L mm	L max mm	€	1	009200839
262	402	88,50		

920/40
quadro maschio 1/2"
snodato a T



L mm	L1 mm	€	2	009200850
490	230	61,00		

920/42
quadro maschio 1/2"
con spina scorrevole

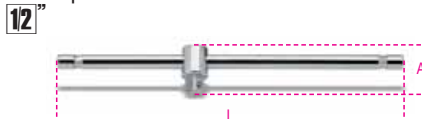

L mm	A mm	€	5	009200854
305	42	18,40		

920/44
quadro maschio 1/2"
ad angolo



L mm	L1 mm	€	3	009200858
230	60	27,00		

920/46
quadro maschio 1/2"
con manovella

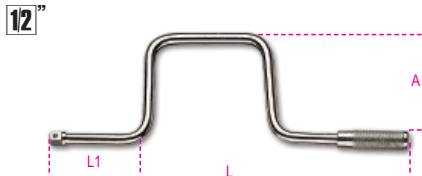

L mm	L1 mm	A mm	€	1	009200862
385	110	160	33,50		

920/50
cricchetto semplice
con attacco quadro scorrevole 1/2"
meccanismo a 72 denti



UNI/ISO 3315 DIN 3122

L mm	Ø mm	A mm	€	3	009200871
275	40	42	58,00		

920/50F
cricchetto semplice
con attacco quadro femmina 1/2"
meccanismo a 72 denti



UNI/ISO 3315 DIN 3122

L mm	Ø mm	A mm	€	2	009200889
275	40	27	53,50		

920/55
cricchetto reversibile
con attacco quadro maschio 1/2"
meccanismo a 72 denti



UNI/ISO 3315 DIN 3122

L mm	Ø mm	A mm	€	3	009200882
275	40	43	62,00		

920/55Q
cricchetto reversibile
con attacco quadro maschio 1/2"
meccanismo a 48 denti



UNI/ISO 3315 DIN 3122

L mm	Ø mm	A mm	€	3	009200885
275	40	43	62,00		

920/55X

cricchetto reversibile
con attacco quadro maschio 1/2"
meccanismo a 72 denti



UNI/ISO 3315 DIN 3122

L mm	Ø mm	A mm	€	Icon	Icon
200	30	33	53,00	3	009200895

920/55LC

cricchetto reversibile
con attacco quadro maschio 1/2"
"Locking System"
meccanismo a 72 denti

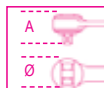

UNI/ISO 3315 DIN 3122

L mm	Ø mm	A mm	€	Icon	Icon
275	40	43	72,00	2	009200896

920M/55

cricchetto reversibile
con attacco quadro maschio 1/2"
con impugnatura in metallo



L mm	Ø mm	A mm	€	Icon	Icon
253	38	35	80,00	1	009200893

920/56A

cricchetto reversibile snodato
con attacco quadro maschio 1/2"
meccanismo a 72 denti



L mm	Ø mm	A mm	€	Icon	Icon
315	40	43	102,00	1	009200911

920M/56

cricchetto reversibile snodato
con attacco quadro maschio 1/2"
con impugnatura in metallo



L mm	Ø mm	A mm	€	Icon	Icon
330	38	35,7	106,50	2	009200894

920/58

cricchetto reversibile
con impugnatura rotante
con attacco quadro maschio 1/2"
meccanismo a 52 denti

- Pulsante di rilascio della bussola
- Sistema di inversione a ghiera sulla testa del cricchetto
- Impugnatura bimatériale



L mm	Ø mm	A mm	€	Icon	Icon
281	42,5	45	93,50	1	009200926

**Meccanismi rotanti
di ricambio dei cricchetti,
vedi tabella dopo l'art. 929/C8**



920.../C11

11 chiavi a bussola
e 2 accessori



920A/C11	€	Icon	Icon
	198,50	1	009200921

920A	10 - 12 - 13 - 14 - 15 - 16 17 - 18 - 19 - 21 - 22 mm
920/22	255 mm
920/50	
335x145x60 mm - 2,5 kg	

920B/C11	€	Icon	Icon
	198,50	1	009200922

920B	10 - 12 - 13 - 14 - 15 - 16 17 - 18 - 19 - 21 - 22 mm
920/22	255 mm
920/50	
335x145x60 mm - 2,5 kg	

920.../C12...

12 chiavi a bussola
e 5 accessori



920A/C12X	€	Icon	Icon
	290,00	1	009200933

920A	10 - 11 - 12 - 13 - 14 - 17 - 19 22 - 24 - 27 - 30 - 32 mm
920/21	125 mm
920/22	255 mm
920/25	
920/42	
920/55	
420x185x60 mm - 4,2 kg	

9899 920C12	€	Icon	Icon
termoformato vuoto	13,90	1	0098990116

920A/C12	€	Icon	Icon
	286,00	1	009200931

920A	10 - 11 - 12 - 13 - 14 - 17 - 19 22 - 24 - 27 - 30 - 32 mm
920/21	125 mm
920/22	255 mm
920/25	
920/42	
920/50	
420x185x60 mm - 4,2 kg	

9899 920C12 € 13,90 1 098990116
termoformato vuoto

920B/C12X € 290,00 1 009200934

- 920B 10 - 11 - 12 - 13 - 14 - 17 - 19
22 - 24 - 27 - 30 - 32 mm
- 920/21 125 mm
- 920/22 255 mm
- 920/25
- 920/42
- 920/55

420x185x60 mm - 4,0 kg

9899 920C12 € 13,90 1 098990116
termoformato vuoto

920B/C12 € 286,00 1 009200932

- 920B 10 - 11 - 12 - 13 - 14 - 17 - 19
22 - 24 - 27 - 30 - 32 mm
- 920/21 125 mm
- 920/22 255 mm
- 920/25
- 920/42
- 920/50

420x185x60 mm - 4,0 kg

9899 920C12 € 13,90 1 098990116
termoformato vuoto

920MC/C14

14 chiavi a bussola esagonali colorate e 5 accessori



920MC/C14 € 305,00 1 009202964

- 920MC 8 - 10 - 11 - 12 - 13 - 14 - 15 - 16 - 17
- 18 - 19 - 21 - 22 - 24 mm
- 920/21 125 mm
- 920/22 255 mm
- 920/25
- 920/42
- 920/55

420x185x60 mm - 4,2 kg

920.../C20...

20 chiavi a bussola e 5 accessori



920A/C20X € 360,00 1 009200950

- 920A 10 - 11 - 12 - 13 - 14 - 15 - 16
17 - 18 - 19 - 20 - 21 - 22 - 23
24 - 26 - 27 - 28 - 30 - 32 mm
- 920/21 125 mm
- 920/22 255 mm
- 920/25
- 920/42
- 920/55

420x185x60 mm - 5,1 kg

9899 920C20 € 13,90 1 098990121
termoformato vuoto

920A/C20 € 356,00 1 009200948

- 920A 10 - 11 - 12 - 13 - 14 - 15 - 16
17 - 18 - 19 - 20 - 21 - 22 - 23
24 - 26 - 27 - 28 - 30 - 32 mm
- 920/21 125 mm
- 920/22 255 mm
- 920/25
- 920/42
- 920/50

420x185x60 mm - 5,1 kg

9899 920C20 € 13,90 1 098990121
termoformato vuoto

920A/C20Q € 360,00 1 009200955

- 920A 10 - 11 - 12 - 13 - 14 - 15 - 16
17 - 18 - 19 - 20 - 21 - 22 - 23
24 - 26 - 27 - 28 - 30 - 32 mm
- 920/21 125 mm
- 920/22 255 mm
- 920/25
- 920/42
- 920/55Q

420x185x60 mm - 5,1 kg

9899 920C20 € 13,90 1 098990121
termoformato vuoto

920B/C20 € 356,00 1 009200949

- 920B 10 - 11 - 12 - 13 - 14 - 15 - 16
17 - 18 - 19 - 20 - 21 - 22 - 23
24 - 26 - 27 - 28 - 30 - 32 mm
- 920/21 125 mm
- 920/22 255 mm
- 920/25
- 920/42
- 920/50

420x185x60 mm - 5,0 kg

9899 920C20 € 13,90 1 098990121
termoformato vuoto

920B/C20X € 360,00 1 009200951

- 920B 10 - 11 - 12 - 13 - 14 - 15 - 16
17 - 18 - 19 - 20 - 21 - 22 - 23
24 - 26 - 27 - 28 - 30 - 32 mm
- 920/21 125 mm
- 920/22 255 mm
- 920/25
- 920/42
- 920/55

420x185x60 mm - 5,0 kg

9899 920C20 € 13,90 1 098990121
termoformato vuoto

920.../C21...

21 chiavi a bussola e 6 accessori



920A/C21 € 414,00 1 009200952

- 920A 10 - 11 - 12 - 13 - 14 - 15 - 16
17 - 18 - 19 - 20 - 21 - 22 - 23
24 - 25 - 26 - 27 - 28 - 30 - 32 mm
- 920/21 125 mm
- 920/22 255 mm
- 920/25
- 920/42
- 920/46
- 920/50

420x280x60 mm - 6,5 kg

920A/C21X € 418,00 1 009200983

- 920A 10 - 11 - 12 - 13 - 14 - 15 - 16
17 - 18 - 19 - 20 - 21 - 22 - 23
24 - 25 - 26 - 27 - 28 - 30 - 32 mm
- 920/21 125 mm
- 920/22 255 mm
- 920/25
- 920/42
- 920/46
- 920/55

420x280x60 mm - 6,4 kg

920B/C21 € 414,00 1 009200953

- 920B 10 - 11 - 12 - 13 - 14 - 15 - 16
17 - 18 - 19 - 20 - 21 - 22 - 23
24 - 25 - 26 - 27 - 28 - 30 - 32 mm
- 920/21 125 mm
- 920/22 255 mm
- 920/25
- 920/42
- 920/46
- 920/50

420x280x60 mm - 6,4 kg



920B/C21X € 418,00 1 009200984

- 920B 10 - 11 - 12 - 13 - 14 - 15 - 16
17 - 18 - 19 - 20 - 21 - 22 - 23
24 - 25 - 26 - 27 - 28 - 30 - 32 mm
- 920/21 125 mm
- 920/22 255 mm
- 920/25
- 920/42
- 920/46
- 920/55

420x280x60 mm - 6,4 kg

920B/C300

30 chiavi a bussola poligonali
e 5 accessori

12"



920B/C30Q € 587,00 1 009200975

- 920B 8 - 9 - 10 - 11 - 12 - 13 - 14
15 - 16 - 17 - 18 - 19 - 20 - 21
22 - 23 - 24 - 26 - 27 - 30 mm
- 920BL 12 - 13 - 14 - 17 - 19 - 21
22 - 24 - 27 - 30 mm
- 920/21 125 mm
- 920/22 255 mm
- 920/25
- 920/42
- 920/55Q

420x280x60 mm - 7,6 kg



920.../C33

20 chiavi a bussola
13 a giravite e 5 accessori

12"



920A/C33 € 575,00 1 009200985

- 920A 10 - 11 - 12 - 13 - 14 - 15 - 16
17 - 18 - 19 - 20 - 21 - 22 - 23
24 - 26 - 27 - 28 - 30 - 32 mm
- 920LP 1,2x8 - 1,6x9 - 2x12 mm
- ⊕ 920PH PH2 - PH3 - PH4
- 920PE 4 - 5 - 6 - 8 - 10 - 12 - 14 mm
- 920/21 125 mm
- 920/22 255 mm
- 920/25
- 920/42
- 920/55

420x280x60 mm - 6,7 kg

920B/C33 € 575,00 1 009200986

- 920B 10 - 11 - 12 - 13 - 14 - 15 - 16
17 - 18 - 19 - 20 - 21 - 22 - 23
24 - 26 - 27 - 28 - 30 - 32 mm
- 920LP 1,2x8 - 1,6x9 - 2x12 mm
- ⊕ 920PH PH2 - PH3 - PH4
- 920PE 4 - 5 - 6 - 8 - 10 - 12 - 14 mm
- 920/21 125 mm
- 920/22 255 mm
- 920/25
- 920/42
- 920/55

420x280x60 mm - 6,7 kg

920A/C17M - 920A/C17MR
assortimento di 17 chiavi a bussola esagonali
e 5 accessori in termoformato morbido, in
cassetta di lamiera

12"



920A/C17M € 329,00 1 009200924

- 920A 10-11-12-13-14-15-16-17-18
19-20-21-22-24-27-30-32 mm
- 920/21 125 mm
- 920/22 255 mm
- 920/25
- 920/42 305 mm
- 920/55

420x185x60 mm - 5 kg

9899 920C17 € 25,50 1 098990137
modulo soft vuoto

920A/C17MR € 361,00 1 009200937

- 920/21 125 mm
- 920/22 255 mm
- 920/25
- 920/42 305 mm
- 920/58

420x185x60 mm 5,1 kg

920/C37

37 chiavi a bussola poligonali
e 5 accessori

12"



920/C37 € 543,00 1 009200988

- 920B 10 - 11 - 12 - 13 - 14 - 15 - 16
17 - 18 - 19 - 20 - 21 - 22 - 23
24 - 26 - 27 - 28 - 30 - 32 mm
- 920AS 3/8 - 7/16 - 1/2 - 9/16 - 19/32
5/8 - 11/16 - 3/4 - 25/32 - 13/16
7/8 - 15/16 - 1 - 1.1/16 - 1.1/8
1.3/16 - 1.1/4
- 920/21 125 mm
- 920/22 255 mm
- 920/25
- 920/42
- 920/55

420x280x60 mm - 7,5 kg



920AS/C10

10 chiavi a bussola poligonali
e 2 accessori

12"



920AS/C10 € 206,00 1 009200919

- 920AS 3/8 - 7/16 - 1/2 - 9/16 - 5/8
11/16 - 3/4 - 13/16 - 7/8 - 15/16
 - 920/22 255 mm
 - 920/50
- 335x145x60 mm - 2,6 kg

920AS/C15

15 chiavi a bussola poligonali
e 6 accessori

12"



920AS/C15 € 384,00 1 009200947

- 920AS 3/8 - 7/16 - 1/2 - 9/16 - 5/8 - 11/16
3/4 - 13/16 - 7/8 - 15/16 - 1
1.1/16 - 1.1/8 - 1.3/16 - 1.1/4
 - 920/21 125 mm
 - 920/22 255 mm
 - 920/25
 - 920/42
 - 920/46
 - 920/50
- 420x280x60 mm - 5,9 kg

920AS/C17X

17 chiavi a bussola poligonali
e 5 accessori

12"



920AS/C17X € 359,00 1 009200942

- 920AS 3/8 - 7/16 - 1/2 - 9/16 - 19/32 - 5/8
11/16 - 3/4 - 25/32 - 13/16 - 7/8
15/16 - 1 - 1.1/16 - 1.1/8 - 1.3/16 -
1.1/4
 - 920/21 125 mm
 - 920/22 255 mm
 - 920/25
 - 920/42
 - 920/55
- 420x185x60 mm - 4,8 kg

920AS/MBM-C21

16 chiavi a bussola poligonali
e 5 accessori
per manutenzioni aeronautiche

12"



920AS/MBM-C21 € 365,00 1 009200944

- 920AS 3/8 - 7/16 - 1/2 - 9/16
19/32 - 5/8 - 11/16 - 3/4
25/32 - 13/16 - 7/8 - 15/16
1 - 1.1/16 - 1.3/16 - 1.1/4
 - 920M/55
 - 920/21 125 mm
 - 920/22 255 mm
 - 920/25
 - 920/42
- 420x185x60 mm - 5,0 kg

920TX/C17

6 inserti per avvitatori
6 chiavi a bussola
5 chiavi a bussola maschio
e 4 accessori, per viti con impronta Torx®



12"



920TX/C17 € 333,00 1 009200989

- 861TX T8 - T10 - T15 - T20 - T25 - T27
 - 897
 - 920TX T27 - T30 - T40 - T45 - T50
 - 920FTX E10 - E12 - E14 - E16 - E18 - E20
 - 920/20 75 mm
 - 920/22 255 mm
 - 920/55
- 420x185x60 mm - 2,9 kg

920A/C17HR

17 chiavi a bussola esagonali
in termoformato rigido, in cassetta di lamiera

• cricchetto con impugnatura rotante

12"



920A/C17HR € 370,00 1 009200939

- 920A 10-11-12-13-14-15-16-17-18
19-20-21-22-24-27-30-32 mm
 - 920/21 125 mm
 - 920/22 255 mm
 - 920/25
 - 920/42
 - 920/58
- 420x185x60 mm - 5,1 kg



920U/C17M

17 chiavi a bussola multimponta,
e 5 accessori
in termoformato morbido

12"



920U/C17M € 337,00 1 009201797

920U ○ 10-11-12-13-14-15-16-17-18-19-20
21-22-24-27-30-32 mm
* 3/8-7/16-15/32-1/2-9/16-19/32-5/8-3/4
25/32-7/8-15/16-1.1/16-1.1/8-1.1/4
○ M12-M14-M16-M18
◎ E12-E14-E16-E18-E20-E22-E24

920/21 125 mm
920/22 255 mm
920/25
920/42 305 mm
920/55 275 mm

420x185x60 mm - 5 kg

9899 920C17 € 25,50 1 098990137
modulo soft vuoto

928A

chiavi a bussola a mano
bocca esagonale



UNI/ISO 2725
DIN 3124

Ø mm	Ø mm	L mm	Ø1 mm	€		
19	29,2	50	34	17,00	5	009280019
21	30,0	51	34	17,30	5	009280021
22	31,3	53	34	17,30	5	009280022
23	33,3	53	34	17,60	5	009280023
24	34,5	53	34	17,90	5	009280024
26	36,8	55	35	19,20	5	009280026
27	38,0	56	35	19,20	5	009280027
28	39,0	57	35	20,30	3	009280028
29	40,2	58	35	20,70	3	009280029
30	41,5	58	37	21,30	3	009280030
32	44,3	60	37	22,40	3	009280032
33	45,8	60	37	23,70	3	009280033
34	46,8	60	37	23,90	3	009280034
35	48,1	62	38	24,20	3	009280035
36	49,5	64	38	24,20	3	009280036
38	52,0	68	40	26,50	3	009280038
41	56,0	71	40	29,50	3	009280041
46	62,3	75	43	36,50	3	009280046
50	67,4	80	43	43,50	3	009280050
55	73,7	84	48	53,50	1	009280055
60	80,0	87	48	62,00	1	009280060

928B

chiavi a bussola a mano
bocca poligonale



UNI/ISO 2725
DIN 3124

Ø mm	Ø mm	L mm	Ø1 mm	€		
19	29,2	50	34	17,00	5	009280119
21	30,0	51	34	17,30	5	009280121
22	31,3	53	34	17,30	5	009280122
23	33,3	53	34	17,60	5	009280123
24	34,5	53	34	17,90	5	009280124
26	36,8	55	35	19,20	5	009280126
27	38,0	56	35	19,20	5	009280127
28	39,0	57	35	20,30	3	009280128
29	40,2	58	35	20,70	3	009280129
30	41,5	58	37	21,30	3	009280130
32	44,3	60	37	22,40	3	009280132
33	45,8	60	37	23,70	3	009280133
34	46,8	60	37	23,90	3	009280134
35	48,1	62	38	24,20	3	009280135
36	49,5	64	38	24,20	3	009280136
38	52,0	68	40	26,50	3	009280138
41	56,0	71	40	29,50	3	009280141
46	62,3	75	43	36,50	3	009280146
50	67,4	80	43	43,50	3	009280150
55	73,7	84	48	53,50	1	009280155
60	80,0	87	48	62,00	1	009280160

928AS

chiavi a bussola a mano
bocca esagonale



Ø mm	Ø mm	L mm	Ø1 mm	€		
7/8	32,0	53	34	19,20	1	009280202
15/16	34,5	53	34	19,20	1	009280203
1	36,2	55	35	20,30	1	009280204
1.1/16	38,0	56	35	21,00	1	009280205
1.1/8	40,2	58	35	21,50	1	009280206
1.1/4	44,2	60	37	23,30	1	009280208
1.5/16	45,8	60	37	24,40	1	009280209
1.3/8	48,1	62	38	25,50	1	009280210
1.7/16	49,5	64	38	26,50	1	009280211
1.1/2	52,0	68	40	29,00	1	009280212
1.5/8	56,0	71	40	31,50	1	009280214
1.11/16	58,8	74	40	36,00	1	009280215
1.13/16	62,3	75	43	40,50	1	009280217
1.7/8	65,0	78	43	43,50	1	009280218
2	68,3	80	43	50,00	1	009280219
2.1/16	71,5	83	48	58,00	1	009280220

928ME

chiavi a bussola
maschio esagonale

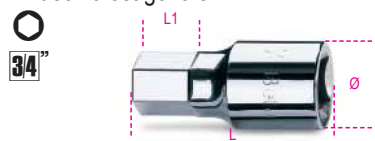

mm	Ø mm	L mm	L1 mm	€		
14	35	75	15,5	39,00	2	009280514
17	35	75	15,5	39,00	2	009280517
19	35	75	15,5	39,00	2	009280519
22	35	75	22,5	39,00	2	009280522

928/15

raccordo con attacco quadro
femmina 3/4" e maschio 1/2"



UNI/ISO 3316
DIN 3123

L mm Ø mm □ 3/4 ■ 1/2 € 20,30 5 009280801



E' assolutamente necessario commisurare la
coppia di serraggio alla capacità del quadro
maschio per evitare rotture o danni accidentali

928/16

raccordo con attacco quadro
femmina 3/4" e maschio 1"



UNI/ISO 3316
DIN 3123

L mm Ø mm □ 3/4 ■ 1" € 24,40 5 009280807

928/20 - 928/21 - 928/22

prolunghe con attacchi quadri
maschio e femmina 3/4"



UNI/ISO 3316
DIN 3123

	L mm	Ø mm	€		
928/20	100	34	23,90	3	009280810
928/21	200	34	32,00	3	009280815
928/22	380	34	47,00	3	009280825

928/25

snodo con attacchi quadri
maschio e femmina 3/4"



UNI/ISO 3316 DIN 3123

L mm Ø mm € 80,50 1 009280830

928/36A

quadro maschio 3/4" snodato
con impugnatura



DIN 3122 - UNI ISO 3315

L
mm
545 € 96,50 1 009280844

928/42

quadro maschio 3/4"
con spina scorrevole

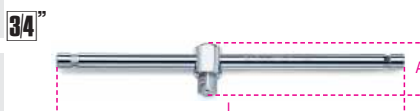

UNI/ISO 3315 DIN 3122

L A
mm mm
450 62,5 € 51,00 3 009280850

928/55

cricchetto reversibile
con attacco quadro maschio 3/4"
meccanismo a 72 denti

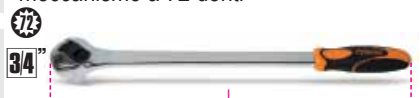

DIN 3122 - UNI ISO 3315

L Ø A
mm mm mm
510 58 59 € 163,50 2 009280862

**Meccanismi rotanti
di ricambio dei cricchetti,
vedi tabella dopo l'art. 929/C8**

928.../C12

12 chiavi a bussola esagonali e 5 accessori in
cassetta di lamiera



928A/C12 € 873,00 1 009280955

928A	22 - 24 - 27 - 30 - 32 - 34 - 36 38 - 41 - 46 - 50 - 55 mm
928/21	200 mm
928/22	380 mm
928/25	
928/42	
928/55	

530x220x80 mm - 13,5 kg

928B/C12 € 873,00 1 009280957

928B	22 - 24 - 27 - 30 - 32 - 34 - 36 38 - 41 - 46 - 50 - 55 mm
928/21	200 mm
928/22	380 mm
928/25	
928/42	
928/55	

530x220x80 mm - 13,5 kg

928AS/C12

12 chiavi a bussola esagonali e 5 accessori in
cassetta di lamiera



928AS/C12 € 899,00 1 009280968

928AS	7/8-15/16-1.1/16-1.1/8-1.1/4 1.5/16-1.7/16-1.1/2-1.11/16 1.13/16-1.7/8-2.1/16
928/21	200 mm
928/22	380 mm
928/25	
928/42	
928/55	

530x220x80 mm - 13,5 kg

929

chiavi a bussola a mano
bocca esagonale

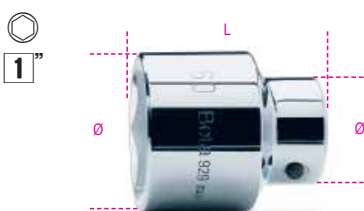

UNI/ISO 2725 DIN 3124

Ø	Ø	L	Ø1	€		
mm	mm	mm	mm			
36	51	65	48	35,50	1	009290036
41	57	70	48	37,50	1	009290041
46	65	75	48	42,00	1	009290046
50	70	80	48	48,50	1	009290050
55	76	85	54	57,00	1	009290055
60	82	90	54	61,00	1	009290060
65	88	95	54	78,50	1	009290065
70	92	100	60	94,00	1	009290070
75	99	110	60	102,00	1	009290075
80	106	120	60	117,00	1	009290080

929/15

raccordo con attacco quadro
femmina 1" e maschio 3/4"

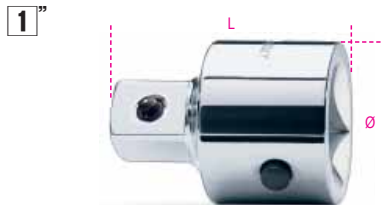

UNI/ISO 3316 DIN 3123

L Ø
mm mm
65 47 1" 3/4 € 42,00 2 009290801



E' assolutamente necessario commisurare la
coppia di serraggio alla capacità del quadro
maschio per evitare rotture o danni accidentali

929/21 - 929/22

prolunghe con attacchi quadri
maschio e femmina 1"



UNI/ISO 3316 DIN 3123

L Ø
mm mm
929/21 200 47 € 54,00 1 009290815
929/22 400 47 € 78,50 1 009290825

929/42

quadro maschio 1"
con spina scorrevole



UNI/ISO 3315 DIN 3122

L
mm
535 € 101,00 1 009290850

929/55

cricchetto reversibile
con attacco quadro maschio 1"
meccanismo a 72 denti



UNI/ISO 3315 DIN 3122

L Ø A
mm mm mm
770 62 63 € 217,50 1 009290860

929/55PR

prolunghe per cricchetti 929/55



L	Ø	Ø1	€	1	009290868
mm	mm	mm	46,50		
540	32	26			

929/C8

8 chiavi a bussola esagonali e 5 accessori

1"



929/C8	€	1	009290925
	1.270,00		

	929	46 - 50 - 55 - 60 - 65 70 - 75 - 80 mm
	929/15	□ 1" - ■ 3/4
	929/21	200 mm
	929/22	400 mm
	929/42	
	929/55	

560x290x120 mm - 29 kg

9899 CV/A

ricambio cassetta vuota



9899 CV/A	€	1	098990001
	34,50		

583/C31-671B/C5-671B/C10-720ME/C8
860/C38P-861/C61P-900/C11-900AS/C10-MB-C17
900/C24-900/C13-8-900/C13-5-900MB/C19-900MB/C28
900/C11HR-900AS/C10-MB-C17-900AS/C17-MBM
900/C11Z-900MC/C24-900MC/C32-910.../C10
971/C8-920TX/C-920PE/C-920FTX/C-910.../C10

270x120x45 mm

9899 CV/B

ricambio cassetta vuota



9899 CV/B	€	1	098990002
	40,00		

352C/U-720MC/C13-727/C16-867/C20-900/C12MR
900/C12MZ-900U/C12M-910AS/C13...-910AS/MBM-C18
910A/C16...-910B/C16...-910A/C16HR
910A/C16...-910B/C16...-920AS/C10-920.../C11-1433/C11
1494/C14A-1529-1545/C5M

335x145x60 mm

9899 CV/C

ricambio cassetta vuota



9899 CV/C	€	1	098990003
	49,00		

920A/C17HR-920A/C17MR-920.../C12...
920A/C17M-910.../C29-902A/C22-867/C38
720/C24-450/C15-353N/C6-960KPC-920MC/C14
920U/C17M-920TX/C17-920.../C20...
920AS/MBM-C21-920AS/C17X-1547/C6-1495/C6
1489/C14-1461/C11A-1608/C9-1606A/C9-1602/C9

420x185x60 mm

900/R55



900/R55	€	1	009000871
	35,50		

666N/2-900/55-666/2-666LBF.FT/2

900/R55-Z



900/R55-Z	€	1	009000872
	35,50		

900M/R55



900M/R55	€	1	009000888
	18,60		

900M/55

910/R55



910/R55	€	1	009100879
	34,50		

599DGT/6-606/6-606/10-612-665/6-665/10-665LB/6
665LB/10-666N/5-666N/10-666N LBF.IN/5-666NLBF.IN/10
666/6-666/10-668RGC/6-668RGC/10-910/55-666/5
666HS/5-666HS/10-666 LBF.FT/5
666 LBF.FT/10

910M/R55



910M/R55	€	1	009100888
	19,20		

910M/55-910M/56

910/R55Q



910/R55Q	€	1	009100877
	34,50		

910/R55X



910/R55X	€	1	009100897
	34,50		

666N/2X-666/2X-666 LBF.FT/2X

920/R50



920/R50	€	1	009200866
	34,00		

614/50-667/20-667/30
667N/20-667N/30-920/50

920/R55



920/R55	€	1	009200879
	41,50		

606/20-606/30-666/20-666/30-920/55
920/56A- 599DGT/20-599DGT/30
599DGT-AN/20-665/20-665/30-665LB/20
665LB/30-666N/20-666N/30
666N LBF.IN/20-666N LBF.IN/30-668RGC/20
666 LBF.FT/20-666 LBF.FT/30

920M/R55



920M/R55	€	1	009200888
	21,50		

920M/55-920M/56

920/R55Q



920/R55Q	€	1	009200877
	41,50		

920/55Q

920/R55X

12"
3/2"



920/R55X
606/10X-612X
666/10X-920/55X-599DGT/10X-599DGT-AN/10
665/10X-665LB/10X-666N10X-666N LBF.IN/10X
668RGC/10X-666 LBF.FT/10X
666HS/20LC-666HS/30LC

€ 34,00 1 009200878

920/R55LC

12"
3/2"



920/R55LC
920/55LC "Locking System"
666HS/20LC-666HS/30LC

€ 43,50 1 009200887

928/R55

3/4"
3/2"



928/R55
928/55

€ 69,00 1 009280859

928/R55X

3/4"
3/2"



928/R55X
614X

€ 44,00 1 009280858

929/R55

1"
3/2"



929/R55
929/55

€ 79,50 1 009290859

930

chiavi a tubo doppie poligonali serie pesante



UNI 6745

mm	L	Ø	Ø1	€		
6x7	100	9,5	11,0	13,90	3	009300006
8x9	108	12,5	14,0	17,50	3	009300010
10x11	116	15,0	16,5	18,30	3	009300014
12x13	124	17,5	19,0	21,50	3	009300018
14x15	132	20,0	21,5	23,40	3	009300023
16x17	140	23,0	24,0	27,00	3	009300027
18x19	148	25,0	26,5	30,00	3	009300032

mm	L	Ø	Ø1	€		
20x22	156	28,0	30,0	33,00	2	009300036
21x23	163	29,0	31,5	35,00	2	009300040
24x26	173	33,0	35,5	44,50	2	009300044
25x28	182	34,5	38,0	48,00	2	009300048
27x29	191	37,0	39,5	55,00	2	009300052
30x32	200	40,5	43,0	66,50	2	009300056



930/S8
6x7-8x9-10x11-12x13-14x15
16x17-18x19-20x22 mm
940/1 - /2

€ 198,50 1 009300081

930/S13
6x7-8x9-10x11-12x13-14x15-16x17
18x19-20x22-21x23-24x26
25x28-27x29-30x32 mm
940/1 - /2 - /3

€ 462,00 1 009300083



930/C13
6x7-8x9-10x11-12x13
14x15-16x17-18x19
20x22-21x23-24x26
25x28-27x29-30x32 mm
940/1 - /2 - /3

€ 532,00 1 009300098

932

chiavi a pipa doppie esagonali-poligonali cromate lucide

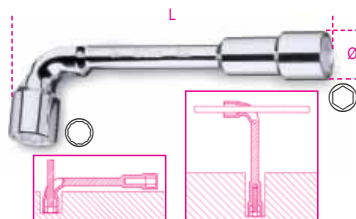

NF E 74.303

mm	Ø	L	€		
6x6	11,5	110	15,60	5	009320006
7x7	12,5	116	15,80	5	009320007
8x8	13,0	120	16,40	5	009320008
9x9	14,0	125	17,00	5	009320009
10x10	16,5	133	17,70	5	009320010
11x11	17,5	143	19,30	5	009320011
12x12	19,0	148	20,50	5	009320012
13x13	19,5	154	21,40	5	009320013
14x14	21,5	167	22,60	5	009320014
15x15	22,5	182	23,80	5	009320015
16x16	24,5	193	24,80	5	009320016
17x17	26,0	198	25,00	5	009320017
18x18	26,5	215	27,50	5	009320018
19x19	29,0	220	30,00	5	009320019
20x20	30,5	222	32,00	3	009320020
21x21	30,5	236	36,50	3	009320021
22x22	32,5	250	40,00	2	009320022
23x23	33,5	256	44,50	2	009320023
24x24	35,0	272	47,50	2	009320024
25x25	36,5	282	50,50	2	009320025
26x26	37,5	296	55,50	2	009320026

mm	Ø	L	€		
27x27	39,0	296	58,00	2	009320027
28x28	39,0	314	66,00	2	009320028
30x30	42,5	348	79,00	2	009320030
32x32	45,5	364	87,50	2	009320032



932/S11
6-7-8-10-11-12
13-14-17-19-22 mm

932/S17
6-7-8-9-10-11-12-13-14-15
16-17-18-19-20-21-22 mm

932/S25
6-7-8-9-10-11-12-13-14-15-16-17-18-19
20-21-22-23-24-25-26-27-28-30-32 mm

€ 244,50 1 009320080

€ 406,00 1 009320081

€ 894,00 1 009320082

933

chiavi a pipa doppie esagonali cromate lucide

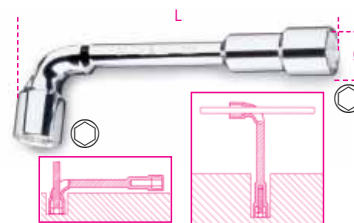

NF E 74.303

mm	Ø	L	€		
6x6	11,5	110	15,60	5	009330006
7x7	12,5	116	15,80	5	009330007
8x8	13,0	120	16,40	5	009330008
9x9	14,0	125	17,00	5	009330009
10x10	16,5	133	17,70	5	009330010
11x11	17,5	143	19,30	5	009330011
12x12	19,0	148	20,50	5	009330012
13x13	19,5	154	21,40	5	009330013
14x14	21,5	167	22,60	5	009330014
15x15	22,5	182	23,80	5	009330015
16x16	24,5	193	24,80	5	009330016
17x17	26,0	198	25,00	5	009330017
18x18	26,5	215	27,50	5	009330018
19x19	29,0	220	30,00	5	009330019
20x20	30,5	222	32,00	3	009330020
21x21	30,5	236	36,50	3	009330021
22x22	32,5	250	40,00	2	009330022
23x23	33,5	256	44,50	2	009330023
24x24	35,0	272	47,50	2	009330024
25x25	36,5	282	50,50	2	009330025
26x26	37,5	296	55,50	2	009330026
27x27	39,0	296	58,00	2	009330027
28x28	39,0	314	66,00	2	009330028
30x30	42,5	348	79,00	2	009330030
32x32	45,5	364	87,50	2	009330032



933/S11
6-7-8-10-11-12-13-14-17-19-22 mm

933/S17
6-7-8-9-10-11-12-13-14-15-16-17
18-19-20-21-22 mm

933/S25
6-7-8-9-10-11-12-13-14-15-16-17-18-19
20-21-22-23-24-25-26-27-28-30-32 mm

€ 244,50 1 009330080

€ 406,00 1 009330081

€ 894,00 1 009330082

935

chiavi a tubo doppie
esagonali
serie leggera



UNI 6746 DIN 896

mm	L mm	€		
6x7	100	8,05	5	009350105
8x9	110	8,65	5	009350111
10x11	120	9,65	5	009350115
12x13	130	10,90	5	009350117
14x15	140	12,70	5	009350126
16x17	150	13,90	5	009350128
18x19	160	16,40	5	009350131
20x22	170	19,90	3	009350138
21x23	180	22,10	3	009350141
24x26	190	25,00	3	009350144
25x28	200	27,50	2	009350150
27x29	210	32,50	2	009350153
30x32	220	35,00	2	009350156



935/S8	€ 114,00	1	009350181
6x7-8x9-10x11-12x13-14x15-16x17 18x19-20x22 mm			
940/1 - /2			
935/S13	€ 270,00	1	009350183
6x7-8x9-10x11-12x13-14x15-16x17 18x19-20x22-21x23-24x26-25x28 27x29-30x32 mm			
940/1 - /2 - /3			

937

chiavi a pipa doppie
esagonali-poligonali
cromate

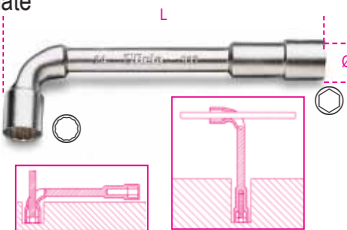

mm	Ø mm	L mm	€		
6x6	11,5	110	8,65	5	009370006
7x7	12,5	116	9,00	5	009370007
8x8	13,0	120	9,35	5	009370008
9x9	14,0	125	9,95	5	009370009
10x10	16,5	133	10,40	5	009370010
11x11	17,5	143	10,90	5	009370011
12x12	19,0	148	12,20	5	009370012
13x13	19,5	154	12,50	5	009370013
14x14	21,5	167	13,70	5	009370014
15x15	22,5	182	15,10	5	009370015
16x16	24,5	193	16,30	5	009370016
17x17	26,0	198	16,90	5	009370017
18x18	26,5	215	17,30	5	009370018
19x19	29,0	220	18,00	5	009370019
20x20	30,5	222	20,40	3	009370020
21x21	30,5	236	22,30	3	009370021
22x22	32,5	250	23,50	2	009370022
23x23	33,5	256	26,00	2	009370023
24x24	35,0	272	27,00	2	009370024
25x25	36,5	282	34,50	2	009370025
26x26	37,5	296	35,50	2	009370026
27x27	39,0	296	36,00	2	009370027
28x28	39,0	314	43,50	2	009370028
30x30	42,5	348	46,50	2	009370030
32x32	45,5	364	52,50	2	009370032



937/S11	€ 145,00	1	009370080
6-7-8-10-11-12 -13-14-17-19-22 mm			
937/S17	€ 246,50	1	009370081
6-7-8-9-10-11-12 -13-14-15-16-17 18-19-20-21-22 mm			

940

spine di manovra per 930-935



	mm	L mm	€		
940/1	6÷13	100	6,00	5	009400001
940/2	14÷22	170	7,85	5	009400002
940/3	21÷32	290	14,20	5	009400003

941

chiavi a pipa esagonali-poligonali
con impugnatura di manovra

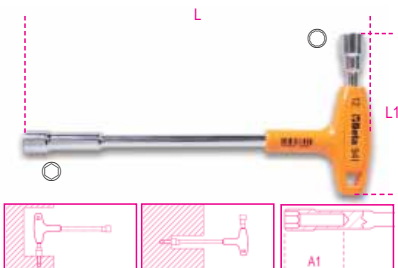

mm	L mm	L1 mm	A1 mm	€		
7x7	200	91	35	29,00	2	009410107
8x8	220	107	50	32,00	2	009410108
9x9	220	109	50	32,00	2	009410109
10x10	236	111	50	32,50	2	009410110
11x11	236	114	50	34,00	2	009410111
12x12	255	122	50	37,50	2	009410112
13x13	255	124	55	38,00	2	009410113



941/S7	€ 235,00	1	009410170
7-8-9-10-11-12-13 mm			

CHIAVI A BUSSOLA CON IMPUGNATURA

Adatte per avvitamenti rapidi e ripetitivi.
Lo spessore minimo delle bocche
esagonali consente accessi in spazi
ristretti.

Il foro di scarico interno agevola la
manovra su dadi con parti filettate
sporgenti, in particolare nel modello
944BX e 949 a bussola profonda.

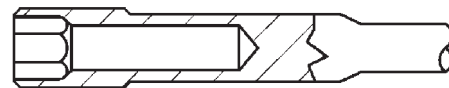

La triplice marcatura sulla testa facilita
l'individuazione della misura.

Lo stelo flessibile del modello 943FL,
costituito da un'anima d'acciaio
protetta da guaina, consente la
trasmissione della coppia in condizioni
di disallineamento con la vite.

942BX

chiavi a bussola esagonale
tipo corto



UNI 6750

mm	L mm	L1 mm	A1 mm	€		
4	190	70	13,0	14,50	5	009420003
5	190	70	14,0	14,50	5	009420004
5,5	190	70	12,5	16,40	5	009420005
6	190	70	14,5	16,40	5	009420006
7	190	70	15,5	17,20	5	009420007
8	202	70	18,5	17,20	5	009420008
9	202	70	19,5	17,20	5	009420009
10	202	70	20,5	18,30	3	009420010
11	202	70	21,5	18,30	3	009420011
12	202	70	22,5	18,30	3	009420012
13	202	70	23,5	20,70	3	009420013
14	202	70	24,5	20,70	3	009420014



942BX/S12	€ 209,50	1	009420030
4-5-5,5-6-7-8-9 10-11-12-13-14 mm			

943BX

chiavi a bussola esagonale
tipo lungo



ISO 2236 UNI 6750

mm	L mm	L1 mm	A1 mm	€	U	PC
4	270	150	13,0	16,10	5	009430003
5	270	150	14,0	16,10	5	009430004
5,5	270	150	12,5	17,30	5	009430005
6	270	150	14,5	17,30	5	009430006
7	270	150	15,5	18,50	5	009430007
8	282	150	18,5	18,50	5	009430008
9	282	150	19,5	18,50	5	009430009
10	282	150	20,5	20,20	3	009430010
11	282	150	21,5	20,20	3	009430011
12	282	150	22,5	20,20	3	009430012
13	282	150	23,5	21,50	3	009430013
14	282	150	24,5	21,50	3	009430014



943BX/S12
4-5-5,5-6-7-8-9
10-11-12-13-14 mm
€ 226,00 1 009430030



943BX/D6
5-6-7-8-10-13 mm
€ 112,00 1 009430026

943FL

chiavi a bussola esagonale flessibili
con impugnatura



mm	L mm	L1 mm	Ø mm	€	U	PC
5	265	150	8	22,70	2	009430304
5,5	265	150	8	22,70	2	009430305
6	265	150	9	22,70	2	009430306
7	265	150	11	22,70	2	009430307
8	265	150	12	23,50	2	009430308
10	290	175	14	25,50	2	009430310



943FL/S6
5-5,5-6-7-8-10 mm
€ 140,00 1 009430320

944BX

chiavi a bussola esagonale profonda
tipo lungo



ISO 2236 UNI 6750

mm	L mm	L1 mm	A1 mm	€	U	PC
4	245	125	20	16,70	3	009440003
5	245	125	25	16,70	3	009440004
5,5	245	125	30	20,40	3	009440005
6	245	125	35	20,40	3	009440006
7	245	125	35	20,40	3	009440007
8	257	125	50	22,00	3	009440008
9	257	125	50	22,00	3	009440009
10	257	125	50	22,90	3	009440010
11	257	125	50	22,90	3	009440011
12	257	125	50	25,00	3	009440012
13	257	125	55	25,00	3	009440013
14	257	125	55	25,00	3	009440014



944BX/S12
4-5-5,5-6-7-8-9
10-11-12-13-14 mm
€ 259,00 1 009440062



944BX/D6
5-6-7-8-10-13 mm
€ 127,50 1 009440056

949

chiavi a T semplici
con bussola esagonale profonda



mm	L mm	L1 mm	A1 mm	€	U	PC
8	220	160	50	30,50	2	009490008
10	230	160	50	32,00	2	009490010
12	240	175	50	33,00	2	009490012
13	244	175	55	34,00	2	009490013
14	250	190	55	36,00	2	009490014
17	264	200	60	41,50	2	009490017



949/S6
8-10-12-13-14-17mm
€ 207,00 1 009490076

950

chiavi a T semplici
esagonali

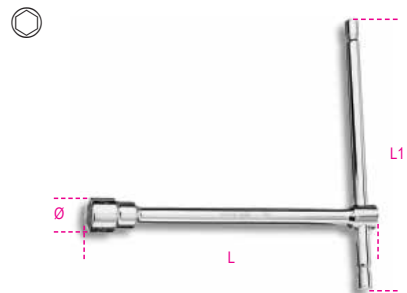

UNI 6742 DIN 3112

mm	L mm	Ø mm	L1 mm	€	U	PC
6	210	10,1	145	21,10	3	009500006
7	212	11,2	145	21,10	3	009500007
8	220	12,4	160	22,70	3	009500008
9	223	13,5	160	22,70	3	009500009
10	230	14,9	160	24,60	3	009500010
11	233	16,1	160	24,60	3	009500011
12	240	17,5	175	27,00	3	009500012
13	244	19,7	175	27,00	3	009500013
14	250	20,1	190	30,50	3	009500014
15	254	21,5	190	32,00	3	009500015
16	260	22,7	200	35,00	3	009500016
17	264	24,1	200	36,00	3	009500017
19	274	26,6	230	44,50	3	009500019
22	290	29,9	290	53,50	2	009500022
24	300	32,2	320	60,50	2	009500024
27	315	36,2	370	71,50	2	009500027



950/S9
7-8-10-11-12
13-14-17-19 mm
€ 258,00 1 009500079

950/S14
6-7-8-9-10-11-12-13
14-15-16-17-19-22 mm
€ 422,00 1 009500082



951 CHIAVI A T CON TRE ESTREMITÀ MASCHIO ESAGONALE



Quando nacque questa chiave rappresentò una rivoluzione. Nata per lavorare su viti ad alta resistenza, offre rapidità di manovra, precisione dell'accoppiamento con la vite e flessibilità d'impiego.

L'astina scorrevole esagonale può essere regolata a piacimento. Le estremità esagonali sono calibrate per trasmettere la massima coppia possibile alla vite. La lunghezza dello stelo permette di applicare notevoli coppie alle viti senza eccessivo sforzo. I continui miglioramenti produttivi portano oggi ad avere finitura sabbata ed estremità esagonali a spigolo vivo, che permettono un accoppiamento migliore anche su viti rovinate.

La marcatura eseguita a laser permette di aumentare la resistenza dello stelo. Il nuovo modello **951GP** è stato sviluppato insieme ai tecnici e meccanici di MotoGP e Superbike per aumentare la velocità durante le operazioni di avvitarimento e svitarimento.

951 chiavi a T con tre estremità maschio esagonale



mm	L mm	L1 mm	Ø mm	€	📦	🚚
2	125	63	4,0	19,30	5	009510521
2,5	150	63	4,0	19,30	5	009510525
3	150	63	4,0	19,30	5	009510530
3,5	175	76	5,5	19,90	5	009510535
4	175	76	5,5	19,90	5	009510540
4,5	195	87	6,5	21,80	5	009510545
5	195	87	6,5	21,80	5	009510550
6	215	99	8,0	25,00	5	009510560
7	230	109	9,0	27,00	5	009510570
8	250	122	10,0	27,00	5	009510580
9	265	132	11,0	34,00	5	009510590
10	280	142	12,0	34,00	5	009510610
12	305	160	15,0	46,00	3	009510620
14	330	178	17,0	55,00	3	009510640

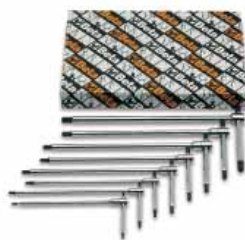

951/S6 2,5-3-4-5-6-8 mm	132,50	1	009510687
951/S8 2-2,5-3-3,5-4-4,5-5-6 mm	166,50	1	009510693
951/S14 2-2,5-3-3,5-4-4,5-5-6-7-8-9-10-12-14 mm	389,00	1	009510695



951/SP6 3-4-5-6-8-10 mm	169,00	1	009510696
951/SPV	31,00	1	009510697



951AS chiavi a T con tre estremità maschio esagonale

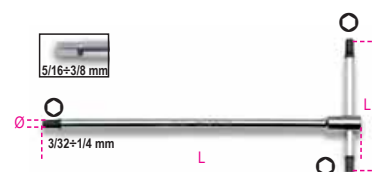

"	L mm	L1 mm	Ø mm	€	📦	🚚
3/32	125	63	4,0	26,00	2	009510750
7/64	150	63	4,0	26,00	2	009510751
1/8	150	63	4,0	26,00	2	009510752
9/64	175	76	5,5	27,00	2	009510753
5/32	175	76	5,5	27,00	2	009510754
3/16	195	86	6,5	29,50	2	009510755
7/32	215	99	8,0	29,50	2	009510757
1/4	230	109	9,0	33,50	2	009510758
5/16	250	122	10,0	34,00	2	009510759
3/8	280	142	12,0	41,50	2	009510760



951AS/S6X 1/8-3/16-7/32-1/4-5/16-3/8	194,00	1	009510771
--	--------	---	-----------

951GP chiavi a T con una estremità maschio esagonale con **astina fissa**

La chiave Beta 951GP offre rapidità di manovra e precisione dell'accoppiamento con la vite. Concepita per risolvere alcune problematiche del mondo Racing: sviluppare coppie elevate e compiere serraggi veloci.

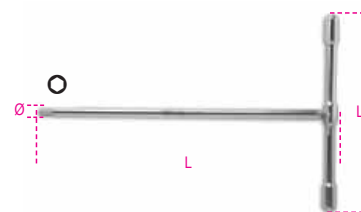

mm	L mm	L1 mm	Ø mm	€	📦	🚚
3	185	130	5	19,00	3	009511530
4	214	150	5	20,00	3	009511540
5	240	165	6	23,00	3	009511550
6	271	180	7	26,50	3	009511560
8	300	200	10	34,00	3	009511580
10	310	200	12	42,00	3	009511610

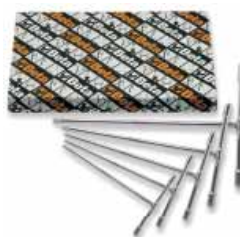

951GP/S6 3-4-5-6-8-10 mm	164,50	1	009511687
------------------------------------	--------	---	-----------

951TX

chiavi a T con tre estremità maschio per viti con impronta Torx®



Ø	L mm	L1 mm	Ø mm	€	3	009510806
T6	125	63	4	23,90	3	009510807
T7	125	63	4	23,90	3	009510808
T8	125	63	4	24,60	3	009510809
T9	125	63	4	24,60	3	009510810
T10	150	63	4	25,00	3	009510815
T15	150	63	4	25,00	3	009510820
T20	175	76	5	26,50	3	009510825
T25	175	76	5	26,50	3	009510827
T27	195	87	6	28,00	3	009510830
T30	195	87	6	28,00	3	009510840
T40	215	99	7	32,50	3	009510845
T45	230	109	8	34,50	3	009510850
T50	250	122	9	37,00	3	009510866

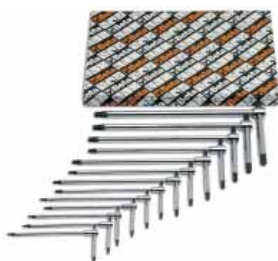

951TX/S6 T8-T10-T15-T20-T25-T30	155,50	1	009510866
951TX/S13 T6-T7-T8-T9-T10-T15-T20-T25 T27-T30-T40-T45-T50	360,00	1	009510863

952 CHIAVI CON BUSSOLA SNODATA

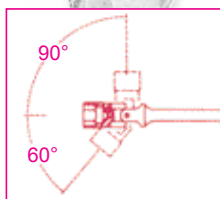
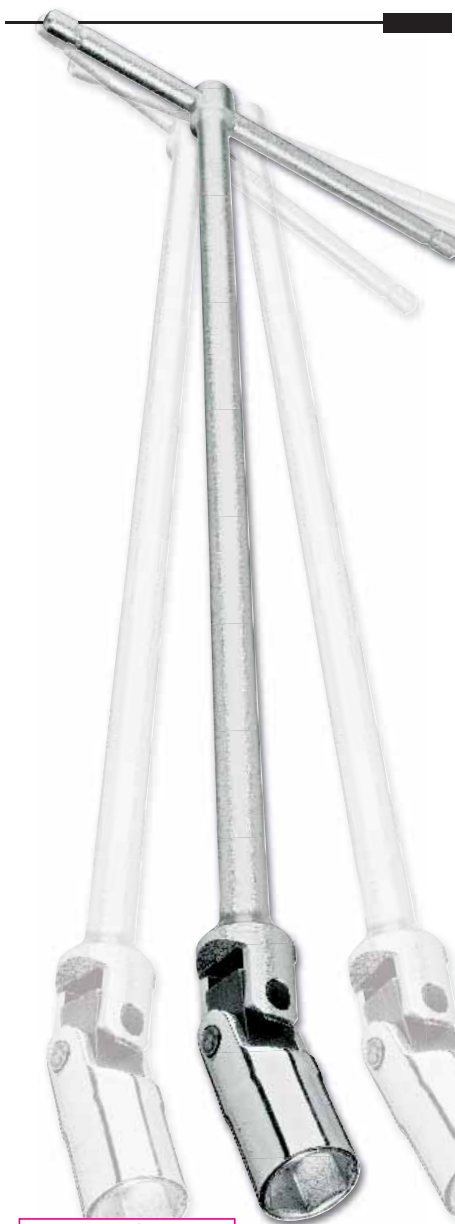

L'affidabilità e la precisione del pre-posizionamento sono le **ragioni** del successo di queste **chiavi**. Lo snodo mantiene la propria funzione nel corso degli anni, senza bisogno di alcuna regolazione. Angolo di rotazione della bussola 60°. Possibilità di utilizzo a 90° in posizione fissa. L'asta di manovra è scorrevole ed è arrestabile nella posizione desiderata su tutta la lunghezza. La triplice marcatura della misura sulla testa ne facilita l'identificazione.

952

chiavi a T con bussola esagonale snodata

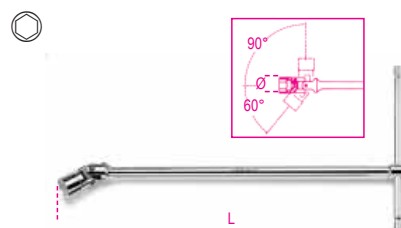

UNI 6743

Ø mm	Ø mm	L mm	€	5	009520006
6	9,5	395	32,50	5	009520007
7	10,7	395	32,50	5	009520008
8	12,1	395	32,50	5	009520009
9	13,2	395	32,50	5	009520010
10	14,6	400	35,00	5	009520011
11	15,8	400	35,00	5	009520012
12	17,0	400	35,00	5	009520013
13	18,7	432	37,50	5	009520014
14	19,7	432	37,50	5	009520015
15	20,9	450	46,00	3	009520016
16	22,0	450	46,00	3	009520017
17	23,4	450	46,00	3	009520018
18	24,7	450	46,00	3	009520019
19	26,0	500	56,00	3	009520020
20	27,4	500	56,00	3	009520021
21	28,5	500	56,00	3	009520022
22	29,7	500	56,00	3	009520024
24	32,4	500	56,00	3	009520074



952/S7 8-10-11-13-14-17-19 mm	279,00	1	009520074
952/S10 7-8-10-11-12-13- 14-15-17-19 mm	393,00	1	009520080
952/S18 6-7-8-9-10-11-12- 13-14-15-16-17- 18-19-20-21-22-24 mm	774,00	1	009520083



952/D7 7-8-10-12-13-14-17 mm	256,00	1	009520079
--	--------	---	-----------

852



852 1/4

79,85

Beta

952AS

chiavi a T con bussola esagonale
snodata

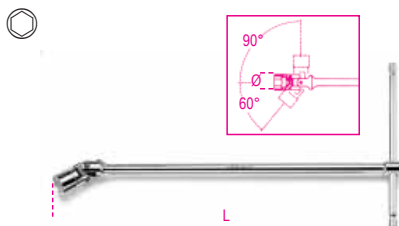

Ø mm	L mm	€	📦	📄
1/4	9,5	35,50	2	009520256
5/16	12,1	35,50	2	009520258
3/8	14,6	38,00	2	009520260
7/16	15,8	38,00	2	009520261
1/2	18,7	43,00	2	009520263
9/16	19,7	46,00	2	009520264
5/8	22,0	49,00	2	009520266
11/16	23,4	49,00	2	009520267
3/4	26,0	61,00	2	009520269

952L

chiavi a T con bussola esagonale
snodata, tipo lungo

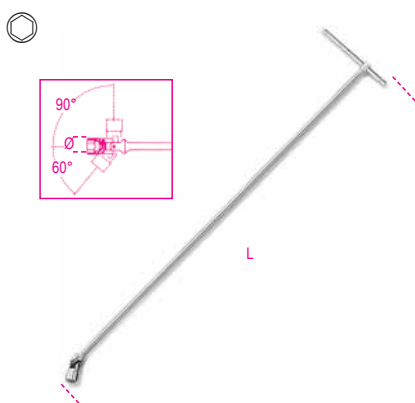

Ø mm	Ø mm	L mm	€	📦	📄
10	14,6	930	89,00	1	009520410
12	17,0	1063	89,00	1	009520412
13	18,7	1100	89,00	1	009520413
14	19,7	1100	89,00	1	009520414
15	20,9	1100	100,00	1	009520415
16	22,0	1100	100,00	1	009520416
17	23,4	1100	100,00	1	009520417
18	24,7	1100	100,00	1	009520418
19	26,0	1100	116,00	1	009520419



952FTX

chiavi a T con bussola snodata
per viti con testa a profilo Torx®

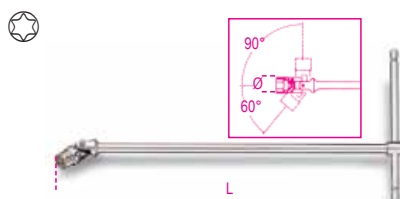

Ø mm	L mm	€	📦	📄
E6	8	38,00	2	009520106
E7	9	38,00	2	009520107
E8	10	44,00	2	009520108
E10	13	45,00	2	009520110
E12	15	54,00	2	009520112
E14	17	49,00	2	009520114
E16	19	66,00	2	009520116
E18	21	66,00	2	009520118
E20	23	66,00	2	009520120



952FTX/S9	€	📦	📄
E6-E7-E8-E10-E12 E14-E16-E18-E20	483,00	1	009520141

953

chiavi a T con maschio esagonale
snodato

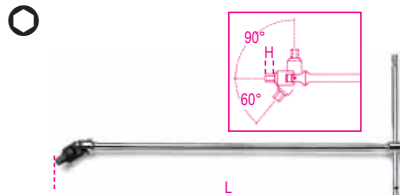

UNI 6754

mm	H mm	L mm	€	📦	📄
3	5	395	33,50	5	009530130
3,5	6	395	33,50	3	009530135
4	6	395	33,50	5	009530140
4,5	7	395	33,50	3	009530145
5	7	395	33,50	5	009530150
6	9	400	36,00	5	009530160
7	10	425	40,00	3	009530170
8	11	425	40,00	5	009530180
10	13	440	47,50	5	009530200



953/S5	€	📦	📄
3-4-5-6-8 mm	176,50	1	009530305
953/S9	€	📦	📄
3-3,5-4-4,5 5-6-7-8-10 mm	331,00	1	009530301

953TX

chiavi a T con maschio snodato
per viti con impronta Torx®

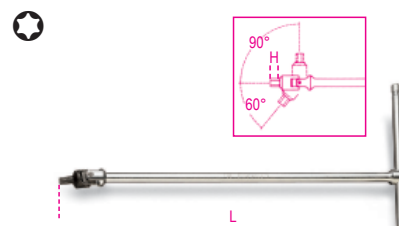

Ø	H mm	L mm	€	📦	📄
T20	11	396	41,00	2	009530020
T25	11	396	41,00	2	009530025
T27	11	396	41,00	2	009530027
T30	13	400	45,00	2	009530030
T40	13	400	45,00	2	009530040
T45	13	426	46,00	2	009530045
T50	14	442	54,00	2	009530050
T55	14	442	54,50	2	009530055



953TX/S8	€	📦	📄
T20-T25-T27-T30 T40-T45-T50-T55	367,00	1	009530060



AUTORIPARAZIONE

I nostri utensili per autoriparazione, usati dai professionisti più esigenti, sono sviluppati e prodotti per soddisfare gli standard più elevati al mondo e testati continuamente nelle condizioni di utilizzo più stressanti.

Da oltre 50 anni, siamo orgogliosamente a fianco dei più grandi campioni, che ci aiutano a migliorare costantemente i nostri prodotti e ne confermano il livello di qualità più assoluta.

Gli utensili dedicati all'autoriparazione si trovano in queste sezioni:

Diagnostica	da 1438 a 1499 da 1758VT a 1760TMC
Motore	da 955 a 989A da 1438 a 1499
Olio e filtri	da 1438 a 1499 da 1877 a 1885
Impianto elettrico	da 1438 a 1499
Avviatori	da 1498BC/12 a 1498/40A
Trasmissione	da 1438 a 1499
Sospensioni	da 1549 a 1569CP
Freni	da 1438 a 1499
Ruote	da 955 a 989A
Carrozzeria	da 1302 a 1369 da 1763 a 1767A
Altre attrezzature	da 1875LT a 3067
Sollevatori	da 3029/2T a 3067/70-13T



955

chiave a tubo semplice
per candele d'accensione



mm -"	D mm	L mm	€	3	009550016
16	21	86	16,60		
5/8					
20,8	29	86	16,60	3	009550021
13/16					

956C

chiavi a bussola
con attacco quadro femmina 1/2"
per candele d'accensione



ISO 11168

mm -"	Ø mm	L mm	€	3	009560008
14	18,8	70	31,00		
9/16					
16	21,4	70	31,00	3	009560010
5/8					
17,8	23,6	70	31,00	3	009560011
11/16					
20,8	27,0	70	31,00	3	009560012
13/16					

956E

chiavi a bussola
con attacco quadro femmina 3/8"
per candele d'accensione



ISO 11168

mm -"	Ø mm	L mm	€	3	009560018
14	18,8	70	34,00		
9/16					
16	21,4	70	34,00	3	009560020
5/8					
17,8	23,6	70	34,00	3	009560021
11/16					
20,8	27,0	70	34,00	3	009560022
13/16					

956F

chiavi a bussola
con attacco quadro femmina 3/8"
per candele d'accensione



mm -"	Ø mm	L mm	€	1	009560114
14	18,8	70	38,00		
9/16					
16	20,5	70	47,00	1	009560116
5/8					

Beta

956L

chiavi a bussola poligonale
con attacco quadro femmina 1/2"
tipo lungo, per candele d'accensione



mm -"	Ø mm	L mm	€	2	009560214
14	19,0	250	63,50		
9/16					
16	21,0	250	65,50	2	009560216
5/8					
17,8	24,0	250	69,00	2	009560217
11/16					

957

chiavi a T con bussola snodata
per candele d'accensione

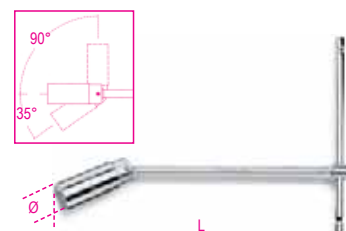

ISO 11168

mm -"	Ø mm	L mm	€	3	009570000
16	21,4	275	47,50		
5/8					
20,8	27,0	275	56,00	3	009570001
13/16					

959

chiavi a T con bussola snodata
tipo normale, per candele d'accensione

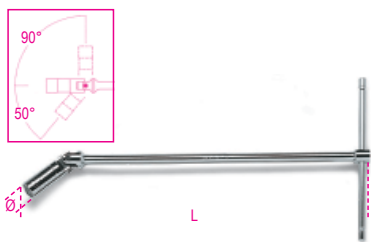

ISO 11168

mm -"	Ø mm	L mm	€		
14 9/16	18,8	483	55,50	3	009590009
16 5/8	21,4	483	61,50	3	009590010
20,8 13/16	27,0	527	82,00	3	009590011

959R

gommino e molla di ricambio
per 956C - 956E - 957 - 959

959R/14 956C/14-956E/14	5,70	3	009590223
959R/16 956C/16-956E/16 957/16-959/16	5,70	3	009590224
959R/17,8 956C/17,8-956E/17,8	5,70	3	009590225
959R/20,8 956C/20,8-956E/20,8 957/20,8-959/20,8-959L	5,70	3	009590226

960

chiavi a bussola
con attacco quadro femmina 1/2"
per iniettori motori Diesel



mm	Ø mm	L mm	€		
27	36,5	77	36,00	2	009600027

960A

chiavi a bussola
con attacco quadro femmina 1/2"
per iniettori motori Diesel



mm	Ø mm	L mm	€		
27	36,5	77	52,50	2	009600017

960BC/C5

serie di 5 chiavi a bussola
per connessione elettrica iniettori

incluse nel kit:

- 1 bussola esagonale aperta da 25 mm
- 1 bussola esagonale aperta da 27 mm
- 1 bussola esagonale aperta da 29 mm
- 1 bussola esagonale aperta da 30 mm
- 1 bussola poligonale da 28 mm



960BC/C5 € 161,50 1 009600280

280x160x55 mm - 1,9 kg

960ER

estrattore a percussione per rondelle iniettori

punta conica a gradini



L mm 350 € 64,50 1 009600726

960F

chiave a bussola
per ghiere portainiettori



Ø mm	Ø1 mm	●1 mm	●2 mm	€		
28,3	22	32	22	41,50	1	009600148

960G

chiave a bussola
per ghiere portainiettori



Ø mm	Ø1 mm	● mm	L mm	€		
28,5	22	32	122	44,00	1	009600151

960L

chiave a bussola
per ghiere portainiettori



Ø mm	Ø1 mm	L mm	€		
30	22	122	47,50	1	009600153

960M

chiave a bussola
per ghiere portainiettori

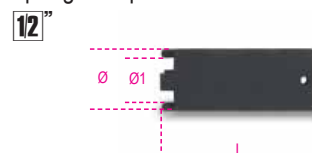

Ø mm	Ø1 mm	L mm	€		
28,5	22	72	35,00	1	009600154

960H/C4

serie di bussole per ghiere portainiettori



960H/C4 € 125,50 1 009600152

960SL

chiavi a bussola per sonda Lambda
con attacco quadro femmina 1/2"

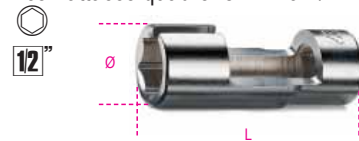

	Ø mm	€		
960SL 85 ○ 22xL= 85 mm	33	62,50	2	009600085
960SL 110 ○ 22xL= 110 mm	33	71,00	2	009600110

960SN

chiavi per candele
di preriscaldamento motori Diesel



mm	Ø mm	□ mm	L mm	€		
8	12,0	1/4	60	53,00	2	009600834
9	13,3	1/4	60	53,00	2	009600835
10	14,5	3/8	70	63,00	2	009600836

960T/C11

assortimento bussole
per rimozione/installazione
sensori

includere nel kit:

- 1 bussola esagonale doppia misura 1" - 1 1/16" per sensori di pressione olio
- 1 bussola esagonale aperta 29 mm per sensori ossigeno
- 1 bussola poligonale aperta 27 mm per iniettori
- 1 bussola esagonale aperta 22 mm per vacuostato
- 1 bussola esagonale aperta 22 mm lunga 80 mm per sensori ossigeno
- 1 bussola esagonale aperta 22 mm lunga 98 mm per sensori ossigeno
- 1 bussola esagonale aperta 22 mm compatta lunga 30 mm per sensori ossigeno
- 1 bussola esagonale aperta 22 mm compatta lunga 50 mm per sensori ossigeno
- 1 bussola aperta 22 mm compatta lunga 34 mm ad impronta esagonale e poligonale, per sensori ossigeno
- 1 bussola esagonale aperta 22 mm con geometria a tubo
- 1 maschio M18x1,5



○ 22 - 29 mm

960T/C11 € 207,00 1 009600031

≡ 330x270x25 mm

960T/A

bussola esagonale aperta 29 mm
per sensori ossigeno



○ mm L mm € 24,30 1 009600032

29 90

960T/B

bussola poligonale aperta 27 mm
per iniettori



○ mm L mm € 21,50 1 009600033

27 85

960T/C

bussola esagonale aperta 22 mm
per vacuostato



○ mm L mm € 18,90 1 009600034

22 88

960T/F

bussola esagonale doppia misura 1" - 1 1/16"
per sensori di pressione olio



○ mm L mm € 14,80 1 009600037

1 - 1 1/16 28 74

960T/G

bussola esagonale aperta 22 mm
con geometria a tubo



○ mm L mm € 42,00 1 009600038

22 25 98

960T/H

bussola aperta 22 mm compatta lunga 34 mm
ad impronta esagonale e poligonale, per
sensori ossigeno



○ mm L1 mm L2 mm € 15,70 1 009600039

22 34 55

960/22EP

chiave snodata a doppia impronta
per sonde Lambda

grande versatilità d'uso grazie alla doppia impronta
esagonale/poligonale e allo snodo a 180°



L mm ○ mm ○ mm € 56,50 1 009600052

300 22 22

960/C6

chiavi esagonali con attacco quadro femmina
3/8"

per rimozione/installazione sensori di
temperatura gas di scarico

Includere nel kit:

- 3 misure in versione corta 13, 14, 17 mm
- 3 misure in versione lunga 13,14,17 mm



960/C6 € 87,50 1 009600055

≡ 170x120x50 mm

960/D

chiavi esagonali aperte versione lunga
per rimozione/installazione sensori di
temperatura gas di scarico



○ mm L mm € 13,60 1 009600073

14 € 13,60 1 009600074

17 € 16,40 1 009600077

960YP

chiavi esagonali aperte versione piegata per rimozione/installazione sensori di temperatura gas di scarico

38"



mm	€	1	009600063
13	14,40	1	009600063
14	14,90	1	009600064
17	19,90	1	009600067

960AVE

attrezzo verifica elettroiniettori Diesel Common Rail BOSCH, SIEMENS, DENSO e DELPHI.



960AVE	€	1	009600245
	279,00	1	009600245

≡ 430x310x50 mm - 2,0 kg

960EPC/L

set di utensili per l'estrazione della punta elettrodo delle candele di preriscaldamento M8x1 - M9x1 - M10x1 - M10x1,25 versione lunga



ZONA DI ROTTURA

960EPC/L	€	1	009600890
	917,00	1	009600890

≡ 270x230x80 mm - 2 kg

960E-PI/P

estrattore per rondelle iniettori

• filetto maschio M10 per utilizzo con estrattore a massa battente (Beta 1540)



960E-PI/P	€	1	009600706
	72,00	1	009600706

≡ 300x90x60 mm

960KC-M8/M9/M10

assortimento di utensili per la rimozione delle candele di preriscaldamento spezzate o danneggiate

• Per candele con filetto M8-M9-M10



960KC-M8/9/10	€	1	009600801
	464,00	1	009600801

≡ 380x290x50 mm - 2,3 kg

960KPC

estrattore reversibile ad impulsi con coppia regolabile per candele di preriscaldamento

Coppia regolabile in 4 posizioni: 10-20-30-40 Nm

14"

CE



960KPC	€	1	009600780
	334,00	1	009600780

≡ 8-9-10-11-12 mm
≡ 420x185x60 mm - 2,8 kg

960UC

set di utensili per estrazione candele bloccate con punta deformata M8-M9-M10



960UC	€	1	009600900
	532,00	1	009600900

≡ 270x230x80 mm - 2,6 kg

960P

tester per controllo pressione/depressione con accessori e adattatori



960P	€	1	009600777
	275,00	1	009600777

≡ 350x320x95 mm - 1,9 kg

960PI

assortimento di alesatori per la pulizia della sede iniettori in cassetta di plastica

Per pulire i residui all'interno della sede iniettori

- Alesatore piatto da Ø 19 - 15 mm per iniettori universali
- Alesatore piatto da Ø 17 - 17 mm per iniettori Delphi/Bosch (BMW/PSA/Renault/Ford)
- Alesatore piatto da Ø 19 - 17 mm per iniettori Bosch (Mercedes CDI).
- Alesatore ad angolo da Ø 21 - 17 mm per iniettori Fiat/Iveco.
- Impugnatura



960PI	€	1	009600215
	128,00	1	009600215

≡ 250x130x50 mm - 600 g

960PI/C19

assortimento di 19 utensili
per la pulizia sedi iniettori

Inclusi nel kit:

- 11 alesatori piatti Ø:
14/14 mm - 15,5/15,5 mm - 15/19 mm - 17/19 mm - 17/17,5 mm
17/17 - 17/19,5 mm - 17/20 mm - 18/21 mm - 19 mm - 20/21 mm
- 4 alesatori ad angolo Ø:
15,5/15,5 mm - 17/17 mm - 17,5/20,5 mm - 17/21 mm
- Impugnatura ed accessori per utilizzo frese



960PI/C19 € 321,00 1 009600217
360x230x60 mm

960PI/K36

kit spazzole per la pulizia
della sede degli iniettori

1/4



DIN 3126 E6,3

960PI/K36 € 202,00 1 009600218
350x255x74 mm 1253 g

960PI/S

kit per pulizia sedi iniettori

Il kit include:

- 3 spazzole in acciaio Ø 18, 22, 25 mm per pulizia sedi iniettori
- 2 spazzole Ø 14 e 16 mm per pulizia fondo sedi iniettori
- 6 tappi per occlusione foro collegamento camera di combustione
- 1 scovolino per pulizia foro collegamento camera di combustione
- 1 portainserti flessibile con impugnatura

1/4



960PI/S € 169,50 1 009600214
360x140x50 mm - 700 g

960VTC

strumento per controllo
perdite cilindri su motori benzina
a seguito dell'inserimento di aria compressa all'interno del
cilindro,
il manometro consente di verificare la presenza
di eventuali perdite di compressione



960VTC € 295,00 1 009600261
373x295x70,6 mm - 2,3 kg

960RPI

attrezzo soffiatore per pulizia sede iniettori

Per motori con candele

M8x1 - M9x1 - M10x1 - M10x1.25



960RPI € 204,50 1 009600940

960PMC

pompa manuale per taratura
e controllo iniettori Diesel



Bar Max. 600 € 807,00 1 009600200

961P6

videoscopio elettronico
con sonda flessibile



CE

- Schermo TFT LCD 3.2"
- Supporta l'utilizzo di SD CARD (8 GB)
- Supporta memorie flash (8 GB)
- Memoria interna da 64M
- Uscita TV-OUT
- Supporta i formati video (MP4, AVI, 3GP)
- 4 led di illuminazione
- Alimentazione tramite presa USB (batteria incorporata)

CARATTERISTICHE TECNICHE

- Pixel del sensore: 640x480
- Risoluzione massima: 320x240
- Lunghezza sonda: 1 mt.
- Diametro camera: 6 mm
- Formati video: MPEG4, 3GP, AVI, ASF.
- Formati foto: JPEG
- Angolo di ripresa: 0+180°
- Uscita dati: cavo USB e SD card
- Alimentazione: batteria 3,7V 2000 mAh

961P6 € 795,00 1 009610000

961P6/S

sonde flessibili 6 mm

IP67



	L mm	€	1	009610006
961P6/S 1	1000	344,00	1	009610006
961P6/S 2	2000	385,00	1	009610262
961P6/S 3	3000	435,00	1	009610263

962

levagomme



L mm	A mm	€	5	009620003
300	21	25,50	5	009620003
400	25	30,50	5	009620004
500	27	39,50	3	009620005
600	27	51,50	3	009620006

962C



962C 277

962P

levagomme con protezione
in gomma antigraffio



L mm	A mm	€		
490	25	96,00	1	009620049

962M

attrezzo per smontaggio/montaggio
pneumatici

particolarmente indicato per Runflat e modelli
con spalle ribassate

- ganasce antigraffio per bloccaggio su cerchi
- sede per inserimento leve smontagomme



962M	€		
	344,00	1	009620501

963

leva con estremità a punta
e piatta curva



L mm	A mm	€		
400	23	39,00	5	009630001

964

leva con estremità a punta
e a becco



L mm	A mm	€		
400	46	35,50	5	009640001

965

leve con estremità piatta curva



L mm	A mm	L1 mm	€		
300	16	185	18,10	2	009650013
450	20	312	25,50	2	009650014
600	20	462	30,00	2	009650016



965/S3	€		
	73,50	1	009650019

966/C3

serie di 3 leve con testa snodata piatta curva



966/C3	€		
L=200-250-300 mm	135,50	1	009660103
355x140x65 mm - 1,8 kg			

720LS

chiavi a bussola Macchina
serie lunga sottile



720LS 36	Ø mm	L mm	Ø1 mm	€		
	36	48,0	78	29	2	007200386

969B

chiave a bussola per serraggio
dado mozzo

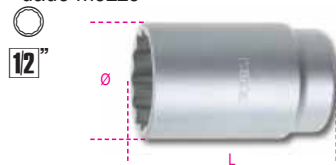

Ø mm	Ø mm	L mm	€		
24	36,0	76	22,90	1	009690124
27	36,0	76	23,40	1	009690127
30	40,0	76	24,10	1	009690130
31	42,0	76	24,80	1	009690131
32	42,5	76	26,50	1	009690132
34	45,0	76	29,50	1	009690134
35	46,0	76	30,00	1	009690135
36	49,0	76	34,50	1	009690136

969/C5

serie di 5 chiavi a bussola
per serraggio dado mozzo
in valigetta di plastica

12"



969/C5	€		
	144,50	1	009690201

969B 30-32-34-35-36

970B

chiave a bussola per serraggio
dadi mozzo Fiat Daily

1"



Ø mm	Ø mm	L mm	€		
65	88	75	112,00	1	009700010

970IVECO

chiave a bussola a settori
per dadi mozzo Iveco Daily
per versioni dall'anno 2014

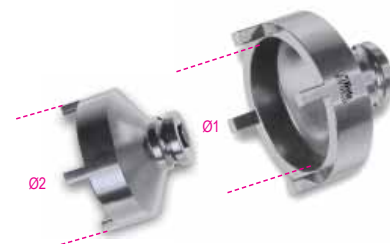

Ø1 mm	Ø2 mm	€		
61,5	74,8	67,50	1	009700011

Beta
Quality Tools

Beta

971/C8

giravite dinamometrico con accessori per il serraggio controllato delle valvole dei pneumatici con sistema di controllo della pressione



971/C8 € 426,00 1 009710108

	583/6	1,2÷6 Nm
	892/0	
	862TX	T10-T15-T20
	900L	11-12 mm
	986 78	

972/C4BMW

kit per rimozione bulloni antifurto con anello libero, tipo BMW e Mini



972/C4 BMW € 246,00 1 009720004

516x145x66 mm - 3,8 kg

972/C10

kit per rimozione dadi ruota danneggiati

utilizzabile su dadi antifurto e tradizionali



972/C10 € 311,00 1 009720010

290x250x60 mm - 2,4 kg

973

kit di 4 protezioni in nylon per ruote

Idoneo per cerchi da:
14" a 18" codice 009730014
19" a 22" codice 009730019



Caratteristiche:

- Conserva e protegge la ruota da eventuali graffi e polvere
- Durante lo stoccaggio, previene il precoce deterioramento dei polimeri della gomma del pneumatico estivo o invernale
- Attraverso un'icona identificativa, permette la facile individuazione della posizione ruota (anteriore destra/sinistra o posteriore destra/sinistra)
- Dotate di impugnatura per un comodo trasporto
- Tessuto: nylon, lavabile

973 14-18 € 108,50 1 009730014
973 19-22 € 120,50 1 009730019

978 - 979

chiavi a croce per dadi ruote

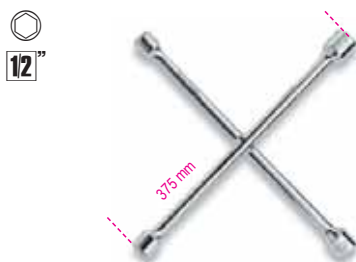

UNI/ISO 6788 DIN 3119

978 € 69,00 2 009780001
17x19x21x22 mm
979 € 69,00 2 009790001
17x19x22x1/2 mm

982

chiavi a croce per dadi ruote

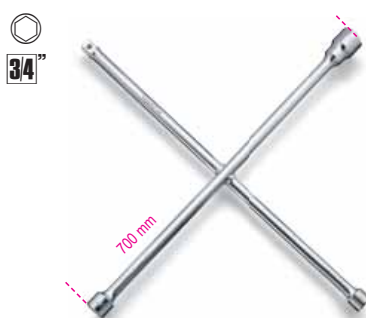

UNI/ISO 6788 DIN 3119

€ 167,00 1 009820001
24x27x32x3/4 mm

983PM

spazzola abrasiva per pulizia mozzi



Ø1 mm 90
Ø2 mm 150
€ 80,50 1 009830010

983 PM/R-DA

coppia dischi abrasivi per 983PM



Ø mm 150
€ 74,50 1 009830050

984

pinza per coperture plastiche dadi ruote



L mm 195
H mm 4
€ 27,50 1 009840005

985/B7

assortimento di 7 perni guida per montaggio ruote

Misure incluse:

- M12x1,25 maschio
- M12x1,25 femmina
- M12x1,5 maschio
- M12x1,5 femmina
- M14x1,25 maschio
- M14x1,5 maschio
- M16x1,5 maschio



C985/B7 € 107,00 1 009850007



985M

perni guida maschio per montaggio ruote



	L mm	€		
985M M12X1,25	150	13,90	1	009850101
985M M12X1,50	150	13,90	1	009850102
985M M14X1,25	150	14,40	1	009850103
985M M14X1,50	150	14,40	1	009850104
985M M16X1,50	150	15,80	1	009850105

985F

perni guida femmina per montaggio ruote



	L mm	€		
985F M12X1,25	150	18,60	1	009850106
985F M12X1,50	150	19,70	1	009850107

986 48

giravite per valvole pneumatici
modello corto
ritenzione automatica della valvola



L mm	L1 mm	€		
18	48	15,80	1	009860048

986 78

giravite per valvole pneumatici
ritenzione automatica della valvola



L mm	L1 mm	€		
18	78	15,80	1	009860078

986PT

giravite prearato 0,4 Nm
per valvole pneumatici

ritenzione automatica della valvola
il meccanismo di slittamento permette
di non danneggiare la guarnizione
del nucleo della valvola



L mm	L1 mm	€		
19	120	55,50	1	009860140

987

leva per valvole pneumatici
con protezione in gomma



L mm	€		
310	32,50	1	009870001

987AR

leva per valvole pneumatici
con fulcro antigraffio
• fulcro in gomma e Nylon
per cerchi in lega ed in ferro
• attacco rapido della valvola,
non necessita di essere avvitata



L mm	€		
305	107,00	1	009870021

987P

leva per valvole pneumatici
in materiale plastico

nel manico è incluso il giravite per agire sul
meccanismo interno alla valvola



L mm	€		
335	27,00	1	009870011

988/K4

serie di 4 scalpelli in plastica anti graffio



988/K4	€		
A= 19-21-25-38 mm	28,50	1	009880104

989

pinza combinata
per equilibratura ruote



L mm	€		
250	51,50	2	009890001

989A

pinza per rimozione piombi adesivi
equilibratura ruote



Profilo dei becchi appositamente studiato per una
rimozione dei piombi senza contatto col cerchione

989A	L mm	€		
	220	35,00	1	009890011

989B

pinza universale per piombi
equilibratura ruote

funzioni:

- rimozione piombi adesivi per cerchi in lega
- rimozione piombi per cerchi in ferro
- martello con copertura in PE-HD removibile per piombi adesivi e per cerchi in ferro
- ganascia per chiusura piombi per cerchi in ferro



L mm	€		
230	66,50	1	009890015

990

pinzetta a molla a punte fini diritte arrotondate, zigrinate in acciaio inossidabile



L mm 130 € 12,70 5 009900001

991

pinzetta a molla a punte fini curve arrotondate, zigrinate in acciaio inossidabile



L mm 130 € 15,30 5 009910001

992

pinzetta a molla con perno a punte fini diritte arrotondate zigrinate, in acciaio inossidabile



L mm 150 € 16,10 5 009920001

993

pinzetta a molla con perno a punte fini curve arrotondate zigrinate, in acciaio inossidabile



L mm 145 € 17,30 5 009930001

993PL

pinzetta a molla a punte fini curve arrotondate, zigrinate in acciaio inossidabile



L mm 150 € 17,30 3 009930010

993G

pinzetta a molla con perno, a punte curve a gomito arrotondate, zigrinate in acciaio inossidabile



L mm 160 € 15,80 3 009930030

994

pinzetta a molla a punte larghe diritte arrotondate, zigrinate in acciaio inossidabile



L mm 150 € 13,20 5 009940001

994PL

pinzetta a molla a punte larghe diritte arrotondate, zigrinate in acciaio inossidabile



L mm 150 € 15,80 3 009940010

994TF

pinzetta a molla, antiacido antimagnetica, a punte larghe diritte arrotondate, zigrinate in acciaio inossidabile



L mm 150 € 21,10 3 009940020

996

pinzetta a molla a becchi diritti a spatola in acciaio inossidabile



L mm 150 € 14,00 5 009960001

998

pinzetta a molla a becchi larghi diritti incrociati, zigrinati in acciaio inossidabile



L mm 155 € 24,20 5 009980001

999

pinzetta a molla antiacido antimagnetica, a punte piatte arrotondate in acciaio inossidabile



L mm 115 € 19,20 3 009990011

999A

pinzette a molla, antiacido antimagnetica, a punte corte finissime in acciaio inossidabile



L mm 120 € 16,60 3 009990015

999B

pinzetta a molla, antiacido antimagnetica, a punte forti diritte in acciaio inossidabile



L mm 120 € 17,00 3 009990017

999C

pinzetta a molla, antiacido antimagnetica, a punte finissime diritte in acciaio inossidabile



L mm 110 € 18,60 3 009990019

999D

pinzetta a molla, antiacido antimagnetica, a punte finissime angolate, in acciaio inossidabile



L mm 115 € 20,50 3 009990021

999E

pinzetta a molla, antiacido antimagnetica, a punte finissime curve in acciaio inossidabile



L mm 120 € 18,60 3 009990023

999G

pinzetta a molla, antiacido, antimagnetica con dispositivo di bloccaggio, a punte finissime diritte in acciaio inossidabile



L mm 140 € 18,60 3 009990027

999/B6N

serie di 6 pinzette a molla antiacido ed antimagnetiche



999/B6N € 119,50 1 009990060
999-999A-999B
999C-999D-999E

1002

pinzetta autobloccante a becchi arrotondati, zigrinati in acciaio inossidabile



L mm 160 € 30,00 2 010020001

1008

pinze a becchi piatti lunghi zigrinati manici ricoperti con 2 strati di PVC antiscivolo



ISO 5745

L mm 160 L1 mm 51,5 € 27,50 5 010080006

1008BM

pinze a becchi piatti lunghi zigrinati impugnatura bimateriale



ISO 5745

L mm 160 L1 mm 51,5 € 33,50 3 010080036

1009

pinze a becchi mezzotondi lunghissimi zigrinati manici ricoperti con 2 strati di PVC antiscivolo



ISO 5745

L mm 160 L1 mm 56,5 € 27,50 2 010090006

1009L/A

pinza a becchi mezzotondi lunghissimi diritti zigrinati, per impieghi speciali manici ricoperti con 2 strati di PVC antiscivolo



L mm 283 L1 mm 80 € 33,50 2 010090008

1009L/B

pinza a becchi mezzotondi lunghissimi zigrinati piegati a 45° per impieghi speciali manici ricoperti con 2 strati di PVC antiscivolo



L mm 273 L1 mm 73 € 34,00 2 010090009

1009L/C

pinza a becchi mezzotondi lunghissimi zigrinati piegati a 90° per impieghi speciali manici ricoperti con 2 strati di PVC antiscivolo



L mm 253 L1 mm 45 € 36,00 2 010090010



1009L/D

pinza a becchi mezzotondi lunghissimi dritti zigrinati, con doppio snodo manici ricoperti con 2 strati di PVC antiscivolo



L mm	L1 mm	€	1	010090058
342	71	40,00		

1009L/DP

pinza a becchi mezzotondi lunghissimi zigrinati piegati a 45°, con doppio snodo manici ricoperti con 2 strati di PVC antiscivolo



L mm	L1 mm	€	1	010090059
336	66	40,00		

1009L/DP-S2

serie di 2 pinze a becchi mezzotondi lunghissimi zigrinati con doppio snodo



1009L/DP-S2	€	1	010090060
	80,00		

1010

pinze a becchi tondi lunghi manici ricoperti con 2 strati di PVC antiscivolo



L mm	L1 mm	€	2	010100006
160	51,5	27,50		

1010BM

pinze a becchi tondi lunghi impugnatura bimateriale



L mm	L1 mm	€	2	010100036
160	51,5	33,50		

PINZE PER ANELLI ELASTICI DI SICUREZZA (SEEGER)

PERFETTO ALLINEAMENTO

I test hanno dimostrato che le pinze Beta garantiscono un ottimo allineamento del seeger (anello elastico) grazie alla speciale geometria a cono inverso delle punte, ottenibile solamente attraverso l'esclusivo stampaggio a freddo impiegato da Beta.



RIDOTTA ROTTURA PUNTE

Le pinze Beta hanno punte monolitiche non riportate, realizzate con stampaggio a freddo, che garantiscono una resistenza maggiore rispetto ai concorrenti sia in fase di utilizzo che di caduta accidentale.



1031/S4

serie di 4 pinze per anelli elastici di sicurezza



1031/S4	€	1	010310000
1032 180	117,50		
1034 170			
1036 175			
1038 175			

1032

pinze a becchi dritti per anelli elastici di sicurezza, per fori manici ricoperti in PVC



L mm	∅ mm	€	5	010320013
140x0,9	8÷12	26,00		
140x1,3	12÷25	25,50		
180	19÷60	27,50		
225	40÷100	34,00		
300	85÷200	47,50		

1033

pinze a becchi piegati a 45° per anelli elastici di sicurezza, per fori manici ricoperti in PVC



UNI 7914 DIN 5256

L mm	∅ mm	€	5	010330013
140x0,9	8÷12	29,50		
140x1,3	12÷25	28,50		
180	19÷60	30,00		
225	40÷100	37,00		

1034

pinze a becchi piegati a 90° per anelli elastici di sicurezza, per fori manici ricoperti in PVC



UNI 7914 DIN 5256

L mm	∅ mm	€	5	010340013
130x0,9	8÷12	29,50		
130x1,3	12÷25	28,50		
170	19÷60	30,00		
210	40÷100	37,00		
290	85÷200	52,50		

1034L

pinza a becchi piegati a 90° lunghi per anelli elastici di sicurezza, per fori manici ricoperti in PVC



L mm	∅ mm	€	Icona	Icona
190	40÷100	75,50	2	010340320

1036

pinze a becchi dritti per anelli elastici di sicurezza per alberi manici ricoperti in PVC



UNI 7915 DIN 5254

L mm	∅ mm	€	Icona	Icona
140x0,9	3÷10	28,00	5	010360013
140x1,3	10÷25	27,50	5	010360014
175	19÷60	28,50	5	010360017
225	40÷100	36,00	3	010360021
300	85÷200	56,50	2	010360028

1037

pinze a becchi piegati a 45° per anelli elastici di sicurezza per alberi manici ricoperti in PVC



UNI 7915 DIN 5254

L mm	∅ mm	€	Icona	Icona
140x0,9	3÷10	31,50	5	010370013
140x1,3	10÷25	30,00	5	010370014
175	19÷60	31,50	5	010370017
225	40÷100	38,50	3	010370021

1038

pinze a becchi piegati a 90° per anelli elastici di sicurezza per alberi manici ricoperti in PVC



UNI 7915 DIN 5254

L mm	∅ mm	€	Icona	Icona
135x0,9	3÷10	31,50	5	010380013
135x1,3	10÷25	30,00	5	010380014
175	19÷60	31,50	5	010380017
220	40÷100	38,50	3	010380021
300	85÷200	61,00	2	010380028



1039

pinza reversibile a becchi dritti per anelli elastici di sicurezza per fori e alberi, manici ricoperti in PVC



L mm	∅ mm	∅ mm	€	Icona	Icona
150	10÷15	6÷25	66,00	2	010390015

1558/C4

attrezzo per anelli seeger interni ed esterni con azionamento a vite

grazie all'attacco quadro si applica una forza elevata in entrambe le condizioni d'utilizzo

Puntali in dotazione:

∅ 2,5-3-3,5 mm



∅ mm	∅ mm	€	Icona	Icona
1558/C4 5,5 ÷ 77	5,5 ÷ 77	178,00	1	015580100

330x220x50 mm - 900 g

1044N

pinza regolabile, fosfatata cerniera sovrapposta manici ricoperti in PVC antiscivolo • Modello a otto posizioni



L mm	A max mm	L1 mm	€	Icona	Icona
250	46	48	30,50	5	010440025

1047

pinza regolabile a pulsante, manici ricoperti con due strati di PVC antiscivolo



L mm	A max mm	L1 mm	€	Icona	Icona
180	30	29	44,50	2	010470180
240	36	35	47,50	2	010470240
300	50	48	68,50	1	010470300

1047BM

pinza regolabile a pulsante con impugnatura bimeriale



L mm	A max mm	L1 mm	€	Icona	Icona
240	36	35	54,50	2	010470340



1048N - POLIGRIP PINZA REGOLABILE A CERNIERA CHIUSA

**PRESA ECCEZIONALE E SORPRENDENTE
MANEGGEVOLEZZA**

- Geometria e angolo dei denti studiati per una presa efficace e sicura sia su profili esagonali che cilindrici
- Denti temprati ad induzione per una maggiore durata
- Maggiore ampiezza dell'angolo testa-impugnatura per una migliore ergonomia
- Fermo di contrasto per evitare lo schiacciamento accidentale della mano
- Manici ricoperti con innovativo PVC antiscivolo
- Maneggevolezza e comfort straordinari grazie alla ampliata superficie di contatto dell'impugnatura



1048N

pinze regolabili cerniera chiusa
manici ricoperti con PVC antiscivolo

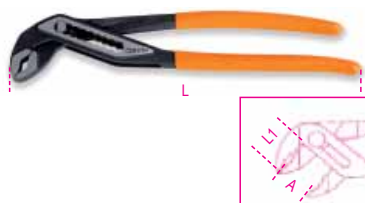

ISO 8976

L mm	A max mm	L1 mm	S mm	€	Icon	Icon
175	36	31	11	32,50	3	010480910
250	46	38	13	35,00	5	010480915
300	60	44	14.8	52,00	2	010480920
400	96	81	19	81,00	1	010480940

1048N/D3

serie di pinze regolabili cerniera chiusa

testa fosfatata



1048N/D3
175-250-300 mm

€ 119,50 1 010480923

1048BM

pinza regolabile a cerniera chiusa,
impugnatura bimateriale

• Modello a nove posizioni



ISO 8976

L mm	A max mm	L1 mm	€	Icon	Icon
250	48	39	47,00	3	010480215

1048VN

pinze regolabili cerniera chiusa
verniciate arancio



ISO 8976

L mm	A max mm	L1 mm	€	Icon	Icon
175	36	31	27,50	3	010480111
250	46	38	31,50	5	010480116
300	60	44	46,00	2	010480121

1050

pinza autobloccante
a doppia regolazione

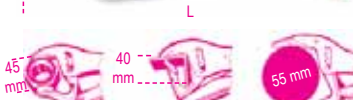

L mm

220 € 83,50 2 010500022

1051

pinza autobloccante
a doppia regolazione, ganasce lunghe



L mm

255 € 91,00 2 010510025

1051GM

pinza autobloccante
a doppia regolazione, ganaschia oscillante



L mm

255 € 97,50 2 010510250

1051L

pinza autobloccante a doppia regolazione
a grande capacità



L mm

270 € 104,00 2 010510100

1051XL

pinza autobloccante a doppia regolazione
a grande capacità, ganasce extra lunghe



L mm

270 € 125,00 2 010510140

1052

pinze regolabili autobloccanti
ganasce concave



L mm

140 A1 max mm € 28,00 3 010520014

190 € 31,50 3 010520019

240 € 34,00 3 010520024

300 € 56,50 2 010520030

1053
pinza regolabile autobloccante
ganascia oscillante

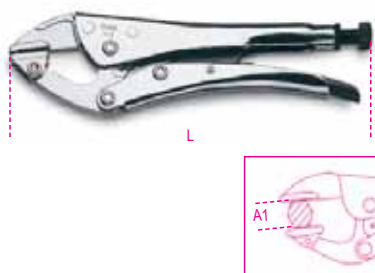

L mm	A1 max mm	€	2	010530024
240	35	47,50		

1054
pinza regolabile autobloccante
ganasce diritte



L mm	A1 max mm	€	2	010540022
235	40	41,50		

1055
pinza regolabile autobloccante
ganasce sagomate

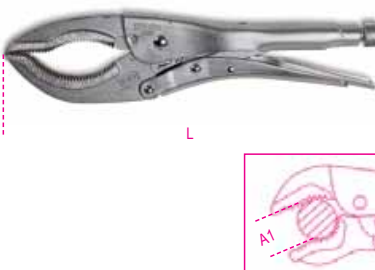

L mm	A1 max mm	€	2	010550027
270	75	37,00		

1055D
pinze regolabili autobloccanti
per dadi e profili cilindrici

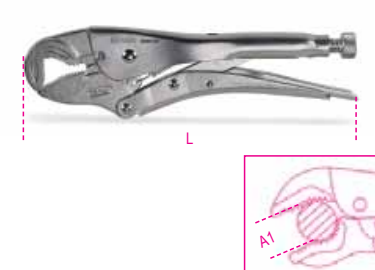

L mm	A1 max mm	€	2	010550119
195	22	29,00		
235	43	32,50		

1056
pinza regolabile autobloccante
per frigoristi

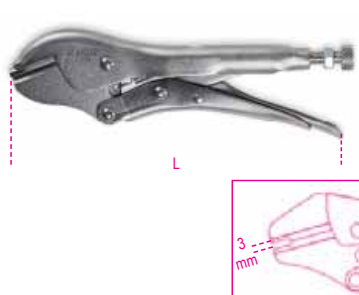

L mm	€	2	010560017
195	28,50		

1057A
pinza automatica autobloccante con
regolazione della forza



L mm	€	2	010570124
240	58,50		

1058
pinze regolabili autobloccanti
becchi lunghi

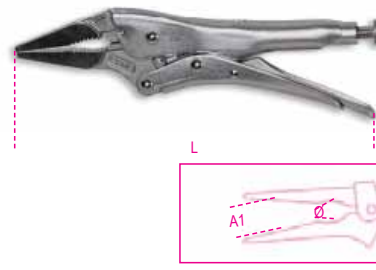

L mm	A1 max mm	Ø max mm	€	2	010580017
175	34	26	35,50		
225	46	31	42,50		

1059
pinze regolabili autobloccanti
con una ganascia parallela mobile

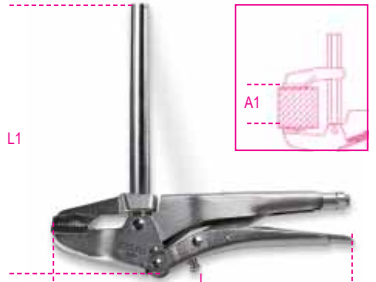

L1 mm	L mm	A1 mm	€	1	010590016
160	255	120	63,50		
270	255	220	66,50		

1060
pinze regolabili autobloccanti
ganasce a forcella

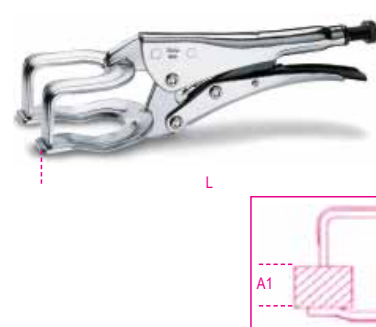

L mm	A1 max mm	€	2	010600020
200	50	45,00		
280	80	57,00		

1061
pinza regolabile autobloccante
ganasce a forcella

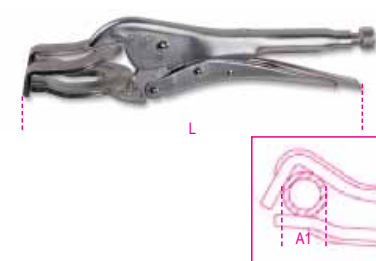

L mm	A1 max mm	€	2	010610027
275	80	49,00		

1062
pinze regolabili autobloccanti
ganasce a collo di cigno

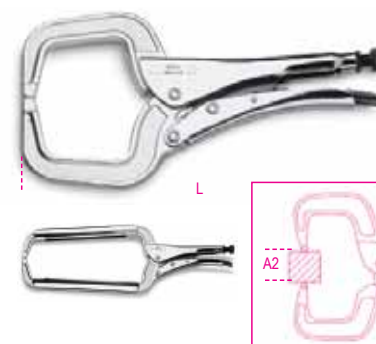

L mm	A2 max mm	€	2	010620017
170	50	35,00		
290	120	46,50		
460	255	66,00		



1062AL

pinza regolabile autobloccante
ganasse a collo di cigno
in alluminio

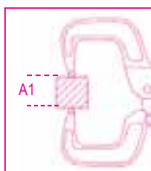

L mm	A1 max mm	€	Icon	Icon	Icon
275	88	61,50	2	010620327	

1062GM

pinze regolabili autobloccanti
ganasse a collo di cigno oscillanti

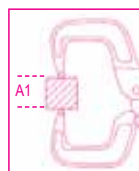

L mm	A1 max mm	€	Icon	Icon	Icon
170	45	38,00	2	010620217	
290	88	54,00	2	010620229	
460	255	76,00	1	010620245	

1063

pinza regolabile autobloccante
per lattonieri

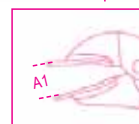

L mm	A1 max mm	€	Icon	Icon	Icon
200	31	45,50	2	010630021	

1064

pinza regolabile autobloccante
a catena



L mm	Ø mm	€	Icon	Icon	Icon
230	150	65,00	2	010640023	

1065F

pinza foralamiera



Ø mm	L mm	€	Icon	Icon	Icon
5	228	124,50	1	010650010	
6	228	125,50	1	010650015	

1065P

pinza piegalamiera



L mm	€	Icon	Icon	Icon
228	128,00	1	010650020	

1066

pinza regolabile autobloccante
bloccaggio a 90°

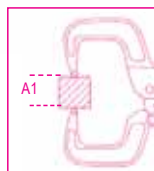

L mm	A1 max mm	g	€	Icon	Icon	Icon
210	55	500	86,00	1	010660021	

1067

pinze regolabili autobloccanti per tubolari,
ganasse blocca tubo snodabili

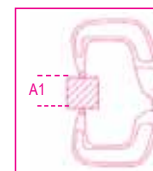

L mm	A1 max mm	€	Icon	Icon	Icon
285	76	54,50	1	010670285	
380	89	56,00	1	010670380	

1077

pinza a becchi larghi dritti
per lattonieri
manici ricoperti in PVC



L mm	A mm	L1 mm	€	Icon	Icon	Icon
280	60	53	56,00	1	010770026	

1078

pinza a becchi larghi piegati a 45°
per lattonieri
manici ricoperti in PVC



L mm	A mm	L1 mm	€	Icon	Icon	Icon
280	60	77	57,00	1	010780026	

1080D

tronchesi a taglianti diagonali rasi
manici ricoperti con 2 strati
di PVC antiscivolo

Per taglio di materiali plastici



α	L mm	L1 mm	€	Icon	Icon	Icon
15°	160	22	30,00	3	010800015	
45°	160	22	36,00	3	010800045	

1081

tronchese a tagliente semiraso
manici ricoperti con 2 strati
di PVC antiscivolo

• Per micromeccanica ed elettronica gravosa

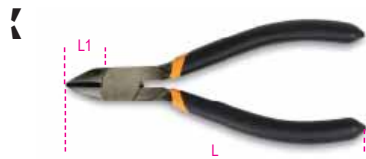

L mm	L1 mm	€	🔧	📦
125	16	31,00	3	010810130

1082

tronchese a taglienti diagonali,
cromati
manici ricoperti con 2 strati di PVC antiscivolo

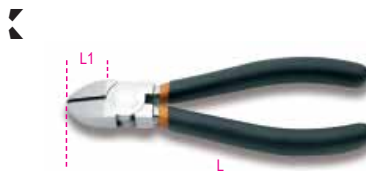

UNI/ISO 5749

L mm	L1 mm	€	🔧	📦
140	20	27,00	5	010820004
160	22	28,00	5	010820006

1082G

tronchese a taglienti diagonali
manici ricoperti con 2 strati
di PVC antiscivolo
finitura industriale



UNI/ISO 5749

L mm	L1 mm	€	🔧	📦
140	20	23,10	5	010820064
160	22	24,30	5	010820066

1082BM

tronchese a taglienti diagonali
impugnatura bimateriale



UNI/ISO 5749

L mm	L1 mm	€	🔧	📦
140	20	33,50	3	010820034
160	22	36,50	3	010820036

1082GBM

tronchese a taglienti diagonali
impugnatura bimateriale
finitura industriale



UNI/ISO 5749

L mm	L1 mm	€	🔧	📦
140	20	29,50	3	010820264
160	22	33,00	3	010820266

1084

tronchese a grande effetto
a taglienti diagonali,
cromati,
manici ricoperti con 2 strati di PVC antiscivolo



UNI/ISO 5749

L mm	L1 mm	€	🔧	📦
160	22	31,50	5	010840006
200	28	39,00	3	010840010

1084G

tronchese a grande effetto
a taglienti diagonali, manici ricoperti
con 2 strati di PVC antiscivolo
finitura industriale



UNI/ISO 5749

L mm	L1 mm	€	🔧	📦
160	22	27,50	5	010840066
200	28	34,00	3	010840070

1084BM

tronchese a grande effetto
a taglienti diagonali,
cromati,
impugnatura bimateriale



UNI/ISO 5749

L mm	L1 mm	€	🔧	📦
160	22	38,00	3	010840036
200	28	49,00	3	010840040

1084GBM

tronchese a grande effetto
a taglienti diagonali,
impugnatura bimateriale,
finitura industriale



UNI/ISO 5749

L mm	L1 mm	€	🔧	📦
160	22	42,00	3	010840266
200	28	54,00	3	010840270

1088

tronchese a grande effetto
a taglienti frontali
manici ricoperti con 2 strati
di PVC antiscivolo

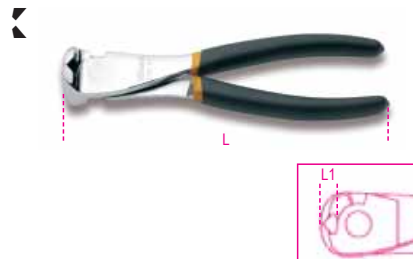

UNI/ISO 5748

L mm	L1 mm	€	🔧	📦
160	9	38,50	2	010880006
200	11	50,50	2	010880010

1088BM

tronchese a grande effetto
a taglienti frontali
impugnatura bimateriale



UNI/ISO 5748

L mm	L1 mm	€	🔧	📦
160	9	47,00	2	010880036
200	11	64,50	2	010880040



1092V

tronchesi a doppia leva
a taglienti frontali
tipo pesante

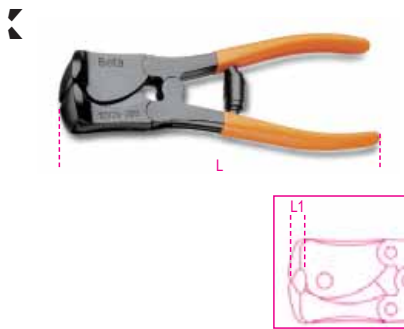

UNI/ISO 5748

L mm	L1 mm	≠ mm	€	🔧	📦
180	8	2,0	154,00	2	010920280
200	9	2,5	162,50	2	010920310

1094V

tronchese a doppia leva
taglienti diagonali
tipo pesante



UNI/ISO 5749

L mm	L1 mm	≠ mm	€	🔧	📦
200	23	2,5	154,00	2	010940200

1095N

tronchese a doppia leva
a taglienti diagonali



L mm	L1 mm	≠ mm	€	🔧	📦
195	26	1,6	54,50	2	010950010

1096

tenaglie per falegnami



ISO 9243

L mm	L1 mm	€	🔧	📦
160	21	20,70	5	010960016
200	23	24,10	5	010960020
250	30	32,50	5	010960025

1098

tenaglie per cementisti



ISO 9242 DIN 5242

L mm	L1 mm	€	🔧	📦
190	12	20,70	5	010980190
220	13	23,40	5	010980220
250	15	28,00	5	010980250
280	18	31,00	5	010980280

1098PL

tenaglie per cementisti
manici ricoperti in PVC



ISO 9242 DIN 5242

L mm	L1 mm	€	🔧	📦
220	13	26,00	5	010980320
250	15	30,00	5	010980350
280	18	33,00	5	010980380

1101

troncabulloni



L mm	L mm	€	🔧	📦
300	12	61,50	2	011010030
350	14	75,00	2	011010035
450	18	92,00	1	011010045
600	24	126,00	1	011010060
750	30	162,50	1	011010075
900	36	217,50	1	011010090

L mm	R = 80 Kg/mm² Ø mm	R = 140 Kg/mm² Ø mm	g
300	5	4	745
350	6	5	1043
450	7	6	1537
600	9	7	2540
750	11	8	3870
900	12	9	6170

1101R

lame di ricambio per 1101



mm	1101	€	🔧	📦
300	300	36,50	1	011010130
350	350	42,50	1	011010135
450	450	54,50	1	011010145
600	600	73,50	1	011010160
750	750	91,00	1	011010175
900	900	120,50	1	011010190

1102

minitroncabulloni

R = ≧80 Kg/mm²



L mm	≠ mm	€	🔧	📦
230	4	45,50	3	011020020

1103

troncabulloni a testa piatta
per tondini, bulloni e reti elettrosaldate per
cemento

Ømax = 12 mm
Ømax (HRC 48) = 6 mm



L mm	€	🔧	📦
950	163,50	1	011030090

1103R

testa di ricambio per 1103



1103R 950	€	🔧	📦
	97,00	1	011030190

1104

tagliafuni per funi flessibili in acciaio
impugnature in materiale plastico



R=80 Kg/mm²

L mm	Ø mm	€	📦	📄
420	12	158,00	1	011040004
600	16	230,50	1	011040006

1104R

lame di ricambio per 1104



mm	€	📦	📄
420	98,00	1	011040014
600	136,50	1	011040016

1105

fustelle in acciaio
brunite

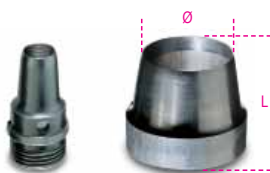

D mm	L mm	€	📦	📄
2	27	15,80	1	011050002
3	27	15,80	1	011050003
4	27	15,80	1	011050004
5	27	15,80	1	011050005
6	27	15,80	1	011050006
7	27	15,80	1	011050007
8	27	15,80	1	011050008
9	27	15,80	1	011050009
10	27	15,80	1	011050010
12	27	19,40	1	011050012
14	27	19,40	1	011050014
16	27	19,40	1	011050016
18	27	19,40	1	011050018
20	27	19,40	1	011050020
22	32	24,20	1	011050022
24	32	24,20	1	011050024
26	32	24,20	1	011050026
28	32	24,20	1	011050028
30	32	24,20	1	011050030
32	37	31,50	1	011050032
34	37	31,50	1	011050034
36	37	31,50	1	011050036
38	37	31,50	1	011050038
40	37	31,50	1	011050040
42	42	37,00	1	011050042
44	42	37,00	1	011050044
46	42	37,00	1	011050046
48	42	37,00	1	011050048
50	42	37,00	1	011050050

1105T20

battifustella per fustelle 1105
da 2 a 20 mm



L mm	€	📦	📄
110	78,50	1	011050200

1105T30

battifustella per fustelle 1105
da 2 a 30 mm



L mm	€	📦	📄
175	169,00	1	011050205

1105T50

battifustella per fustelle 1105
da 2 a 50 mm



L mm	€	📦	📄
175	167,00	1	011050207

1105AD-50

adattatore per battifustella 1105T50



Ø mm	€	📦	📄
57	105,50	1	011050210

1105/C10T

assortimento di 10 fustelle
da 3 a 20 mm e 1 accessorio



1105C/10T	€	📦	📄
	175,50	1	011050250

📦	1105	3 - 4 - 6 - 8 - 10 - 12 - 14 - 16 - 18 - 20 mm	
📦	1105T20		

📏 135x92x32 mm

1105/C16T

assortimento di 15 fustelle
da 3 a 30 mm e 1 accessorio



1105C/16T	€	📦	📄
	317,00	1	011050255

📦	1105	3 - 4 - 6 - 8 - 10 - 12 - 14 - 16 - 18 - 20 - 22 - 24 - 26 - 28 - 30 mm	
📦	1105T30		

📏 240x210x60 mm

1105/C32T

assortimento di 29 fustelle
da 2 a 50 mm e 3 accessori



1105C/32T	€	📦	📄
	619,00	1	011050257

📦	1105	2 - 3 - 4 - 5 - 6 - 7 - 8 - 9 - 10 - 12 - 14 - 16 - 18 - 20 - 22 - 24 - 26 - 28 - 30 - 32 - 34 - 36 - 38 - 40 - 42 - 44 - 46 - 48 - 50 mm	
📦	1105T50		
📦	1105AD-50		

📏 455x380x115 mm

1112

cesoie modello americano
lame larghe diritte

R = 60 Kg/mm²



L mm	L1 mm	S mm	A mm	€	📦	📄
200	50	0,5	26	27,50	2	011120020
250	62	0,8	33	33,00	2	011120025
300	76	1,0	37	42,50	2	011120030
375	76	1,2	44	62,50	1	011120037

1114

cesoia modello americano
lame strette diritte

R = 60 Kg/mm²

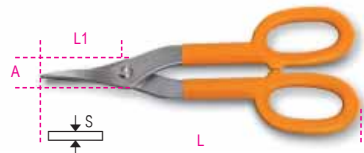

L	L1	S	A	€	Icon	Icon
mm	mm	mm	mm			
250	58	0,5	15	29,50	1	011140265
350	76	1	22	38,50	1	011140340

1118

cesoia antinfortunistica per taglio reggia

Fe = acciaio comune

Inox = acciaio inossidabile



L	L1	Fe	Inox	€	Icon	Icon
mm	mm	S mm	S mm			
310	42	1	0,8	48,00	2	011180001

1120A

cesoia roditrice

Fe = acciaio comune



L	Fe	€	Icon	Icon
mm	S mm			
280	1,2	77,00	1	011200101

1120ARL - ARG

ricambi per 1120A



	€	Icon	Icon
1120ARL	19,20	1	011200110
1120ARG	24,10	1	011200120

1122

cesoia a doppia leva
lame diritte

Inox = acciaio inossidabile



L	L1	Inox	A	€	Icon	Icon
mm	mm	S mm	mm			
250	40	1	24	37,00	2	011220020

1123

cesoia a doppia leva destrorsa
lame curve

Inox = acciaio inossidabile



L	L1	Inox	A	€	Icon	Icon
mm	mm	S mm	mm			
250	40	1	24	37,00	2	011230020

1124

cesoia a doppia leva sinistrorsa
lame curve

Inox = acciaio inossidabile



L	L1	Inox	A	€	Icon	Icon
mm	mm	S mm	mm			
250	40	1	24	37,00	2	011240020

1125

cesoia a doppia leva
per tagli diritti e destrorsi

Inox = acciaio inossidabile



L	L1	Inox	A	€	Icon	Icon
mm	mm	S mm	mm			
250	35	1	46	58,00	2	011250020

1126

cesoia a doppia leva
per tagli diritti e sinistrorsi

Inox = acciaio inossidabile



L	L1	Inox	A	€	Icon	Icon
mm	mm	S mm	mm			
250	35	1	46	58,00	2	011260020

1122 - 1125MOL



	€	Icon	Icon
1122 MOL	1,66	1	011220010
1123 MOL	1,41	1	011230010
1125 MOL	1,41	1	011250040

1127

forbici per telefonisti lame diritte



L	L1	€	Icon	Icon
mm	mm			
150	35	16,10	5	011270001

1128BAX

forbici per elettricisti a doppio effetto,
con profili a fresa in acciaio inossidabile
rivestito in DLC

taglio a doppio effetto: attraverso una speciale camma sul fulcro si ottiene uno scorrimento longitudinale delle lame che, nella fase di chiusura, ne aumenta la potenza di taglio.

profilo a fresa: studiate per allargare fori su plastica da 13 a 25 mm.

rivestimento DLC: Il DLC (diamond-like carbon) è un rivestimento innovativo a base di carbonio: l'elevata durezza ed il basso coefficiente d'attrito nascono dalla simultanea presenza di carbonio depositato sulla superficie in forma di grafite e diamante.

- alta durezza superficiale delle lame (resistenza all'abrasione e mantenimento dell'affilatura nel tempo)
- basso coefficiente di attrito (scorrevolezza e potenza di taglio)
- perno eccentrico antiallentamento
- manici ampi con gole strozzatubi



L	L1	mm ²	€	Icon	Icon
mm	mm				
150	50	50	35,50	5	011280088

1128BMX

forbici per elettricisti
lame diritte in acciaio inossidabile
con microdentatura



L	L1	€	Icon	Icon
mm	mm			
147	58,2	18,90	5	011280059

1128BMX/F

custodia in plastica
per 1128BMX



	€	Icon	Icon
1128BMX/F	1,91	1	011280059

1128FXS FORBICI PER ELETTRICISTI CON SVASATORE

Abbiamo ridisegnato la forbice per elettricisti osservando il lavoro quotidiano degli utilizzatori. L'abbiamo resa un utensile universale, inglobando le 4 funzioni principali in un unico oggetto.

TAGLIO rapido e netto per cavi fino a 50 mm² grazie alla gola trancia-cavo e a una lama microdentata per una maggior presa.

SPELLATURA la sensibilità del perno anti-allentamento permette di spellare con precisione anche i cavi più fini.

CRIMPATURA sicura e resistente nel tempo per terminali a tubetto.

SVASATURA l'esclusivo profilo a fresa consente di svasare i fori delle cassette di derivazione in maniera precisa e pulita.



1128BAX FORBICI PER ELETTRICISTI A DOPPIO EFFETTO, CON PROFILI A FRESA IN ACCIAIO INOSSIDABILE RIVESTITO IN DLC

Le forbici 1128BAX si caratterizzano per la finitura delle lame in DLC. Il DLC (diamond-like carbon) è un rivestimento innovativo a base di carbonio. L'elevata durezza ed il basso coefficiente d'attrito nascono dalla simultanea presenza di carbonio depositato sulla superficie in forma di Grafite e Diamante.

- Alta durezza superficiale delle lame - resistenza all'abrasione e mantenimento dell'affilatura nel tempo
- Basso coefficiente di attrito - scorrevolezza e potenza di taglio

Profilo a fresa: studiato per allargare fori su plastica da 13 a 25 mm.



+DUREZZA
-COEFFICIENTE D'ATTRITO



1128BSX

forbici per elettricisti con svasatore
lame dritte in acciaio inossidabile

- Studiate per allargare fori su plastica e chiudere tubi corrugati
- Con custodia plastica



L mm	L1 mm	€	5	011280061
148	58,2	32,50		

1128FX

forbici per elettricisti
lame dritte in acciaio inossidabile
con microdentatura, gola trancia-cavo e
crimpatore per terminali a tubetto.

- Custodia agganciabile alla cintura
- Impugnatura bimatereale
- Perno anti-allentamento



L mm	L1 mm	mm ²	€	5	011280090
145	52	50	34,50		

1128FXS

forbici per elettricisti con svasatore
lame in acciaio inossidabile
con microdentatura, gola trancia-cavo e
crimpatore per terminali a tubetto.

- Custodia agganciabile alla cintura
- Impugnatura bimatereale
- Perno anti-allentamento
- profilo e fresa: studiate per allargare fori su plastica da 13 a 21 mm.



L mm	L1 mm	mm ²	€	5	011280095
145	52	50	41,00		

1128BM

forbici per elettricisti
lame dritte



L mm	L1 mm	€	5	011280000
145	50	16,40		

1129BM

forbici per elettricisti
lame curve



L mm	L1 mm	€	5	011290000
145	44	17,50		

1130BMX

forbici multiuso
lame dritte in acciaio inossidabile
con microdentatura



L mm	L1 mm	€	1	011300002
185	60	21,20		

1131CK

forbici per Kevlar® e fibre ottiche

in acciaio specificatamente studiato per operare su materiali antitaglio come fibre aramidiche
Anche per fibre ottiche



L mm	L1 mm	€	1	011310001
203	75	85,00		

1132

tagliacavi
manici ricoperti con 2 strati
di PVC antiscivolo per tagli di cavi isolati
di rame e alluminio



UNI 8791

L	mm	mm ²	€	Icona	Icona
170	14	50	52,50	2	011320107
230	18	95	64,50	2	011320113

1132BM

tagliacavi
impugnatura bimatereale
per cavi isolati in rame e alluminio



UNI 8791

L	mm	mm ²	€	Icona	Icona
170	14	50	64,50	2	011320137
230	18	95	79,00	2	011320143

1133

tagliacavi
per cavi in rame flessibile



L	mm	mm ²	€	Icona	Icona
600	30	325	179,50	1	011330001

1133RL

lame di ricambio per 1133



1133RL	135,00	1	011330011
--------	--------	---	-----------

1134

tagliacavi a cricchetto



L	mm	mm ²	€	Icona	Icona
260	35	400	523,00	1	011340032

1134RL

lama di ricambio per 1134



1134RL	237,00	1	011340132
--------	--------	---	-----------

1134A

tagliacavi a cricchetto



L	mm	mm ²	€	Icona	Icona
240	45	500	795,00	1	011340045



1142BM

pinza spellafili
impugnatura bimatereale



UNI 7923

L	mm	mm ²	mm	€	Icona	Icona
160	0,5-6	0-2,8		42,50	3	011420036

1143

pinza spellafili



L	mm	mm ²	mm	€	Icona	Icona
165	0,5-6	1-3,2		83,50	1	011430001

1143R

lame di ricambio per 1143

1143R	21,10	1	011430011
-------	-------	---	-----------

1144D

spellacavi con lama regolabile per tagli
trasversali e longitudinali



L	mm	mm ²	mm	€	Icona	Icona
170	4,5-240	2,5-18		100,50	1	011440010

1144D/RG

gancio di ricambio per 1144D



1144D/RG	33,50	1	011440012
----------	-------	---	-----------

1144D/RL

lame di ricambio per 1144D

1144D/RL	51,50	1	011440011
----------	-------	---	-----------

1144G

spellacavi con lama regolabile per tagli
trasversali e longitudinali



L	mm	mm ²	mm	€	Icona	Icona
140	6-75	2,8-12		56,00	1	011440004

1144G/RL

lama di ricambio per 1144G



1144G/RL € 12,40 1 011440005

1144L

spellacavi con lama regolabile per tagli trasversali e longitudinali

• Con lama retrattile liscia e a uncino



L mm 145 $\frac{\text{mm}^2}{\text{mm}}$ 6-150 $\frac{\text{mm}}{\text{mm}}$ 4-28 € 32,50 1 011440050

1144T

spellacavi tascabile regolabile, con dispositivo di taglio



L mm 112 $\frac{\text{mm}}{\text{mm}}$ 3,5 ÷ 9 g 40 € 22,50 1 011440060

1148A

pinza spellafili autoregolabile con dispositivo di taglio



L mm 190 $\frac{\text{mm}^2}{\text{mm}}$ 0,02 ÷ 10 $\frac{\text{mm}}{\text{mm}}$ 0-4 € 171,50 1 011480100

1148A/R

lame di ricambio per 1148A



1148A/R € 73,50 1 011480102

Beta

1148B

pinza spellafili autoregolabile con dispositivo di taglio



L mm 190 $\frac{\text{mm}^2}{\text{mm}}$ 4 ÷ 16 $\frac{\text{mm}}{\text{mm}}$ 2-5 € 201,50 1 011480200

1148B/R

lame di ricambio per 1148B



1148B/R € 92,00 1 011480202

1148P

pinza spellafili autoregolabile con dispositivo di taglio



L mm 165 $\frac{\text{mm}^2}{\text{mm}}$ 0.2-6 $\frac{\text{mm}}{\text{mm}}$ 0-3.5 € 48,00 1 011480300

1149F

pinza spellafili frontale autoregolabile, con dispositivo di taglio



L mm 175 $\frac{\text{mm}^2}{\text{mm}}$ 0,2 ÷ 6 € 18,60 1 011490010

1150

pinze universali a grande effetto, cromate
manici ricoperti con 2 strati di PVC antiscivolo

• Il perno decentrato aumenta l'effetto leva, riducendo lo sforzo, per un taglio di grande potenza.



ISO 5746

L mm	L1 mm	$\frac{\text{mm}}{\text{mm}}$	€		
160	42	1,6	23,80	5	011500046
180	46	1,8	26,00	5	011500048
200	50	2,0	28,00	5	011500050
220	50	2,0	31,00	2	011500052

1150G

pinze universali a grande effetto
manici ricoperti con 2 strati di PVC antiscivolo
finitura industriale

• Il perno decentrato aumenta l'effetto leva, riducendo lo sforzo, per un taglio di grande potenza.



ISO 5746

L mm	L1 mm	$\frac{\text{mm}}{\text{mm}}$	€		
160	42	1,6	22,20	5	011500066
180	46	1,8	24,20	5	011500068
200	50	2,0	27,00	5	011500070
220	50	2,0	28,00	2	011500072

Beta

1150HPC PINZA UNIVERSALE HYPERCUT CON TAGLIENTI IN ACCIAIO SINTERIZZATO M2

- Il perno decentrato avvicina il fulcro al punto di taglio, aumentando l'effetto leva
- Il perfetto allineamento dei becchi e il profilo assottigliato garantiscono presa sicura anche in spazi molto ristretti
- Il corpo della pinza utilizza l'affidabile acciaio al molibdeno lavorato termicamente per essere flessibile e resistente e garantire una presa sicura in ogni condizione

Sforzo di taglio prova statica = **-73%**

Vita media dei taglienti = (test ISO 5744) **+127%**

Durezza dei taglienti M2 = **65HRC**

- **INNOVAZIONE ASSOLUTA**
- **FINITURA CROMATA PERLATA**
- **GRANDE FORZA DI TAGLIO**

1150HPC

pinza universale a **grande effetto** con tagliente a inserto, perno decentrato, cromata perlata, impugnatura bi-materiale, cassetta aperta

Tagliente a inserto
Acciaio: M2
Spessore: 0.20 mm
Angolo: 62°
Durezza: 65 HRC



ISO 5746

L mm	L1 mm	≠ mm	€	🔧	📦
180	42	1,8	65,00	2	011500618

1150BM

pinze universali a **grande effetto**, cromate
impugnatura bimateriale

- Il perno decentrato aumenta l'effetto leva, riducendo lo sforzo, per un taglio di grande potenza.



ISO 5746

L mm	L1 mm	≠ mm	€	🔧	📦
160	42	1,6	29,50	3	011500146
180	46	1,8	32,50	3	011500148
200	50	2,0	35,50	3	011500150
220	50	2,0	38,00	2	011500152

1150GBM

pinze universali a **grande effetto** impugnatura bimateriale **finitura industriale**

- Il perno decentrato aumenta l'effetto leva, riducendo lo sforzo, per un taglio di grande potenza.



ISO 5746

L mm	L1 mm	≠ mm	€	🔧	📦
160	42	1,6	27,50	3	011500266
180	39	1,8	29,50	3	011500268
200	50	2,0	33,50	3	011500270
220	50	2,0	35,50	2	011500272

1153

pinza regolabile a due posizioni manici ricoperti con 2 strati di PVC antiscivolo



UNI ISO 9343

L mm	L1 mm	€	🔧	📦
200	34	27,00	2	011530120

1162

pinze a becchi piatti lunghissimi diritti zigrinati cromate
manici ricoperti con 2 strati di PVC antiscivolo



ISO 5745

L mm	L1 mm	≠ mm	€	🔧	📦
160	58	1,6	28,00	5	011620006
200	86	1,6	32,50	5	011620010



1162G

pinze a becchi piatti
lunghe diritte zigrinati
manici ricoperti con 2 strati di PVC antiscivolo
finitura industriale



ISO 5745

L	L1	mm	€		
mm	mm	mm			
160	58	1,6	23,80	5	011620066
200	86	1,6	27,50	5	011620070

1162BM

pinze a becchi piatti
lunghe diritte zigrinati
cromate
impugnatura bimatereale



ISO 5745

L	L1	mm	€		
mm	mm	mm			
160	58	1,6	34,00	3	011620036
200	86	1,6	38,00	3	011620040

1162GBM

pinze a becchi piatti
lunghe diritte zigrinati
impugnatura bimatereale
finitura industriale



ISO 5745

L	L1	mm	€		
mm	mm	mm			
160	58	1,6	29,50	3	011620266
200	86	1,6	34,50	3	011620270

1164

pinze a becchi piatti
lunghe piegate zigrinati
manici ricoperti con 2 strati di PVC antiscivolo



ISO 5745

L	L1	mm	€		
mm	mm	mm			
160	54	1,6	30,50	5	011640006
200	76	1,6	34,00	5	011640010

1164BM

pinze a becchi piatti
lunghe piegate zigrinati
impugnatura bimatereale



ISO 5745

L	L1	mm	€		
mm	mm	mm			
160	54	1,6	37,00	3	011640036
200	76	1,6	42,00	3	011640040

1166

pinze a becchi mezzotondi lunghe diritte zigrinati
cromate
manici ricoperti con 2 strati di PVC antiscivolo



ISO 5745

L	L1	mm	€		
mm	mm	mm			
160	56	1,6	28,00	5	011660006
200	76	1,6	32,50	5	011660010

1166G

pinze a becchi mezzotondi lunghe diritte zigrinati
manici ricoperti con 2 strati di PVC antiscivolo
finitura industriale



ISO 5745

L	L1	mm	€		
mm	mm	mm			
160	56	1,6	23,80	5	011660066
200	76	1,6	27,50	5	011660070

1166BM

pinze a becchi mezzotondi lunghe diritte zigrinati
cromate
impugnatura bimatereale



ISO 5745

L	L1	mm	€		
mm	mm	mm			
160	56	1,6	34,00	3	011660036
200	76	1,6	38,00	3	011660040

1166GBM

pinze a becchi mezzotondi lunghe diritte zigrinati
impugnatura bimatereale
finitura industriale



ISO 5745

L	L1	mm	€		
mm	mm	mm			
160	56	1,6	29,50	3	011660266
200	76	1,6	34,50	3	011660270

1168

pinze a becchi mezzotondi lunghe piegate zigrinati
cromate
manici ricoperti con 2 strati di PVC antiscivolo



ISO 5745

L	L1	mm	€		
mm	mm	mm			
160	54	1,6	30,50	5	011680006
200	76	1,6	34,00	5	011680010

1168G

pinze a becchi mezzotondi lunghe piegate zigrinati
manici ricoperti con 2 strati di PVC antiscivolo
finitura industriale



ISO 5745

L	L1	mm	€		
mm	mm	mm			
160	54	1,6	26,00	5	011680066
200	76	1,6	29,50	5	011680070

1168BM

pinze a becchi mezzotondi lunghissimi piegati zigrinati cromate impugnatura bimatériale



ISO 5745

L mm	L1 mm	mm	€		
160	54	1,6	37,00	3	011680036
200	70	1,6	42,00	3	011680040

1168GBM

pinze a becchi mezzotondi lunghissimi piegati zigrinati impugnatura bimatériale finitura industriale



ISO 5745

L mm	L1 mm	mm	€		
160	54	1,6	33,00	3	011680266
200	70	1,6	37,00	3	011680270

1169/D3

assortimento di 1 pinza universale, 1 pinza becchi mezzotondi lunghi e 1 tronchese, con 2 strati di PVC antiscivolo cromati



1169/D3	€		
1082 160mm 1150 180mm 1166 160mm	82,00	1	011690053

1169G/D3

assortimento di 1 pinza universale, 1 pinza becchi mezzotondi lunghi e 1 tronchese, con 2 strati di PVC antiscivolo con finitura industriale



1169G/D3	€		
1082G 160mm 1150G 180mm 1166G 160mm	72,50	1	011690073

1169BM/D3

assortimento di 1 pinza universale, 1 pinza becchi mezzotondi lunghi e 1 tronchese, impugnatura bimatériale cromati



1169BM/D3	€		
1082BM 160mm 1150BM 180mm 1166BM 160mm	103,00	1	011690133

1169GBM/D3

assortimento di 1 pinza universale, 1 pinza becchi mezzotondi lunghi e 1 tronchese, impugnatura bimatériale, con finitura industriale



1169GBM/D3	€		
1082GBM 160mm 1150GBM 180mm 1166GBM 160mm	92,00	1	011690273

1169N/D4

Assortimento di 1 pinza universale, 1 pinza becchi mezzotondi lunghi, 1 tronchese cromati e 1 pinza a cerniera chiusa fosfatata



1169N/D4	€		
1082 160 mm 1150 180 mm 1166 160 mm 1048N 250 mm	117,00	1	011690024

1171BM

pinza per elettronica a becchi piatti corti lisci impugnatura bimatériale

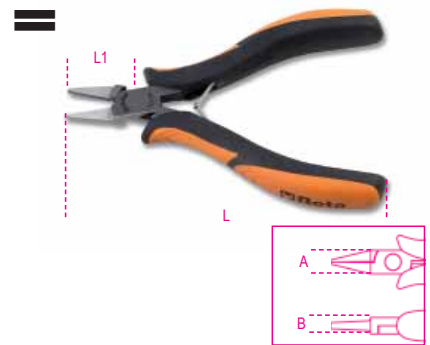

ISO 9655

L	L1	A	B	€		
130	18	12	8	46,50	2	011710101

1172BM

pinza per elettronica a becchi piatti lunghi lisci impugnatura bimatériale

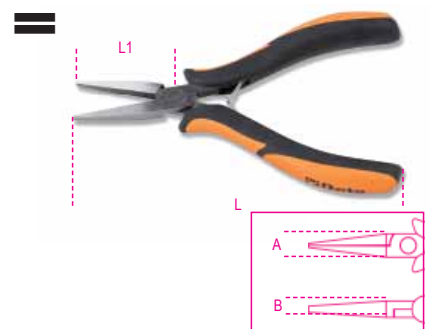

ISO 9655

L	L1	A	B	€		
140	40	12	8	46,50	2	011720101



1172BM/P

pinza per elettronica
a becchi piatti lunghi piegati lisci
impugnatura bimatériale

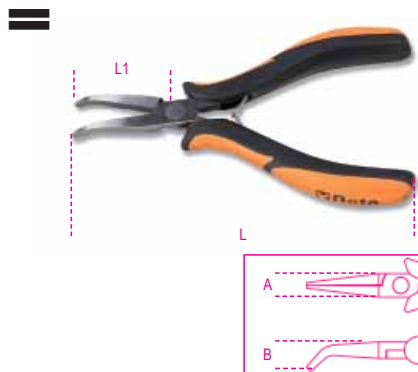

L	L1	A	B	€	Icon	Icon
mm	mm	mm	mm			
140	38	12	13	53,50	2	011720102

1173BM

pinza per elettronica
a becchi tondi corti
impugnatura bimatériale



L	L1	A	B	€	Icon	Icon
mm	mm	mm	mm			
125	22	12	8	46,50	2	011730101

1175BM

pinza per elettronica
a becchi mezzotondi corti lisci
impugnatura bimatériale



L	L1	A	B	€	Icon	Icon
mm	mm	mm	mm			
140	29	12	8	46,50	2	011750101

1177BM

pinza per elettronica
a becchi mezzotondi lunghi lisci
impugnatura bimatériale



L	L1	A	B	€	Icon	Icon
mm	mm	mm	mm			
140	38	12	8	46,50	2	011770101

1177BM/Z

pinza per elettronica
a becchi mezzotondi lunghi zigrinati
impugnatura bimatériale

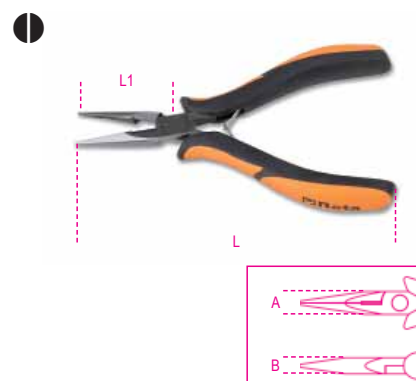

L	L1	A	B	€	Icon	Icon
mm	mm	mm	mm			
140	39	12	8	53,50	2	011770113

1178BM

pinza per elettronica
a becchi mezzotondi lunghi lisci rastremati
impugnatura bimatériale



L	L1	A	B	€	Icon	Icon
mm	mm	mm	mm			
140	37	12	8	53,50	2	011780101

1178BM/P

pinza per elettronica
a becchi mezzotondi lunghi lisci rastremati
piegati
impugnatura bimatériale



L	L1	A	B	€	Icon	Icon
mm	mm	mm	mm			
140	36,5	12	12	53,50	2	011780102

Seguono tronchesi per rame.
Per usi piú gravosi vedere l'articolo 1081

1182BM

tronchese per elettronica
a taglienti diagonali semirasi
becchi assottigliati
impugnatura bimatériale



L	L1	A	Cu	€	Icon	Icon
mm	mm	mm	mm			
120	11	10	1	53,50	2	011820101



1183BM

tronchese per elettronica
a taglienti diagonali semirasi
becchi arrotondati
impugnatura bimatériale



ISO 9654

L	L1	A	Cu	€	Impugnatura	Art.
mm	mm	mm	mm			
120	11	10	1	53,50	2	011830101
130	11	10	1	53,50	2	011830102

1184BM

tronchese per elettronica
a taglienti diagonali rasi
becchi arrotondati
impugnatura bimatériale



ISO 9654

L	L1	A	Cu	€	Impugnatura	Art.
mm	mm	mm	mm			
120	11	10	1	53,50	2	011840101
130	13	12,5	1,25	53,50	2	011840102

1185BM

tronchese per elettronica
a taglienti diagonali rasi
becchi assottigliati
impugnatura bimatériale



ISO 9654

L	L1	A	Cu	€	Impugnatura	Art.
mm	mm	mm	mm			
120	11	10	1	53,50	2	011850101
130	13	12,5	1,25	53,50	2	011850102

1186BM

tronchese per elettronica
a taglienti diagonali rasi
becchi assottigliati scaricati
impugnatura bimatériale



ISO 9654

L	L1	A	Cu	€	Impugnatura	Art.
mm	mm	mm	mm			
120	11	10	1	53,50	2	011860101
130	13	12,5	1,25	53,50	2	011860102

1188BM

tronchese per elettronica
a taglienti diagonali normali
impugnatura bimatériale



ISO 9654

L	L1	A	Cu	€	Impugnatura	Art.
mm	mm	mm	mm			
125	12	12	1,25	53,50	2	011880101
130	17	15	2	53,50	2	011880102

1190BM

tronchese per elettronica
a taglienti frontali normali
impugnatura bimatériale



ISO 9654

L	L1	A	Cu	€	Impugnatura	Art.
mm	mm	mm	mm			
120	12	12	1,25	53,50	2	011900113

1191BM

tronchese per elettronica
a taglienti obliqui sottili
becchi lunghi sottili
impugnatura bimatériale



ISO 9654

L	L1	A	Cu	€	Impugnatura	Art.
mm	mm	mm	mm			
130	8	12	0,8	53,50	2	011910101

1191BM/L

tronchese per elettronica
a taglienti obliqui rasi e spellafilo
impugnatura bimatériale



ISO 9654

L	L1	A	Cu	€	Impugnatura	Art.
mm	mm	mm	mm			
130	18	12	1	53,50	2	011910110

1191R/5-M

kit molle di ricambio per pinze e tronchesi per
elettronica, 5 coppie (Art.: 1171...1191)

1191R/5-M	€ 10,50	1	011910995
-----------	---------	---	-----------

1200MS

magnetizzatore-smagnetizzatore

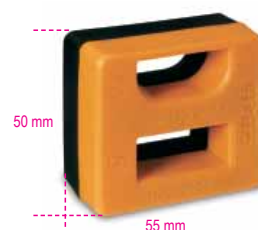

1200MS	€ 16,70	5	012000000
--------	---------	---	-----------

Il design ergonomico si adatta perfettamente al palmo della mano. L'ampia superficie di contatto permette di trasmettere il massimo della forza con il minore sforzo.

Le collaudate lame Beta offrono elasticità, durezza e resistenza all'usura ai vertici della categoria dei giravite professionali.

La sezione ottagonale evita il fastidioso rotolamento sul piano di lavoro. L'area di precisione permette al giravite di girare rapidamente tra le dita.

Facilmente appendibile grazie al foro sull'impugnatura.

La nuova gomma termoplastica rende ancora più confortevole ogni utilizzo, anche il più gravoso.

Impronta e misura sono riportate sulla calotta sferica per una rapida individuazione



● Le collaudate lame Beta offrono **elasticità, durezza e resistenza** all'usura ai vertici della categoria dei giravite professionali

● Il **design ergonomico** si adatta perfettamente al palmo della mano. L'ampia superficie di contatto permette di trasmettere il massimo della forza con il minore sforzo

● La **sezione ottagonale** evita il fastidioso rotolamento sul piano di lavoro

● La nuova gomma termoplastica rende ancora più **confortevole** ogni utilizzo, anche il più gravoso

● L'**area di precisione** permette al giravite di girare rapidamente tra le dita

● Novità assoluta è la sua **appendibilità**, grazie al foro sull'impugnatura



● Impronta e misura sono riportate sulla **calotta sferica** per una rapida individuazione

1201E

giravite per viti a testa con intaglio



ISO 2380

SxAxL mm	L1 mm	Ø mm	€		
0,4x2,5x50	146	2,5	4,15	5	012011003
0,4x2,5x75	166	2,5	4,30	5	012011006
0,5x3x75	171	3,0	4,35	5	012011009
0,5x3x100	196	3,0	4,70	5	012011012
0,6x3,5x75	171	3,5	4,70	5	012011018
0,6x3,5x100	196	3,5	4,80	5	012011021
0,8x4x100	196	4,0	4,85	5	012011030
0,8x4x125	221	4,0	5,15	5	012011033
0,8x4x150	246	4,0	5,55	5	012011036
1,0x5,5x100	209	5,0	6,10	5	012011039
1,0x5,5x125	234	5,0	6,40	5	012011040
1,0x5,5x150	259	5,0	6,50	5	012011042
1,2x6,5x100	220	6,0	7,25	5	012011048
1,2x6,5x125	234	6,0	7,50	5	012011050
1,2x6,5x150	270	6,0	7,65	5	012011051
1,2x8x150	282	8,0	9,85	3	012011057
1,2x8x200	332	8,0	10,60	3	012011060
1,6x10x200	332	9,5	12,30	3	012011066



1201E/S6

0,5x3x75-0,6x3,5x100
0,8x4x100-1,0x5,5x100
1,2x8x150-1,6x10x200 mm

€ 42,00

1 012011206

1201EN

giravite per viti a testa con intaglio tipo cortissimo



ISO 2380

SxAxL mm	L1 mm	Ø mm	€		
0,8x4x30	86,5	4	5,95	3	012011103
1,2x6,5x30	86,5	6	6,30	3	012011106

1201E/DZ

giravite per viti con impronta Dzus®



L mm	L1 mm	€	Icon	Icon	Icon
53	173	14,70	2	012011501	

1202E

giravite per viti con impronta a croce Phillips®



UNI-ISO 8764

PHxDxL mm	L1 mm	€	Icon	Icon	Icon
0x3x60	156	4,30	5	012021003	
0x3x100	200	4,80	5	012021006	
1x4,5x80	189	5,50	5	012021009	
1x4,5x120	229	6,25	5	012021012	
2x6x100	220	7,50	5	012021018	
2x6x150	270	8,05	5	012021021	
3x8x150	282	10,30	3	012021024	
4x9,5x200	332	13,50	3	012021027	



Icon	Icon	Icon	Icon	Icon	Icon
1202E/S4	PH0x3x60-PH1x4,5x120	PH2x6x150-PH3x8x150 mm	29,00	1	012021204

1202EN

giravite per viti con impronta a croce Phillips® tipo cortissimo



UNI-ISO 8764

PHxDxL mm	L1 mm	€	Icon	Icon	Icon
1x4,5x30	86,5	5,95	3	012021103	
2x6x30	86,5	6,30	3	012021106	

1202EL

giravite per viti con impronta a croce Phillips®, tipo lungo

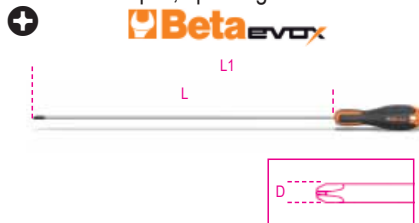

UNI-ISO 8764-1

PHxDxL mm	L1 mm	€	Icon	Icon	Icon
0x3x300	400	7,65	3	012021303	
1x4,5x300	400	8,35	3	012021305	
1x4,5x400	508	10,20	3	012021306	
2x6x400	519	11,70	3	012021309	

1203E/D

serie giravite



Icon	Icon	Icon	Icon	Icon	Icon
1203E/D5	0,6x3,5x100-1,0x5,5x150	1,2x6,5x150 mm	32,00	1	012031001
1202E	PH1x4,5x80-PH2x6x100 mm				

Icon	Icon	Icon	Icon	Icon	Icon
1203E/D5PZ	0,5x3x75-0,8x4x125	1,0x5,5x150 mm	31,00	1	012031003
1209E/PZ	PZ1x4,5x80-PZ2x6x100 mm				

Icon	Icon	Icon	Icon	Icon	Icon
1203E/D6	PH1x4,5x80-PH2x6x100 mm	0,4x2,5x60-0,5x3x100	33,00	1	012031006
1204E	0,8x4x100-1,0x5x125 mm				

Icon	Icon	Icon	Icon	Icon	Icon
1203E/D7	0,5x3x75-0,8x4x100	1,0x5,5x100-1,2x6,5x150 mm	40,00	1	012031007
1202E	PH0x3x60-PH1x4,5x80	PH2x6x100 mm			

Icon	Icon	Icon	Icon	Icon	Icon
1203E/D8	0,5x3x75-0,8x4x125	1,0x5,5x150-1,2x6,5x150 mm	51,00	1	012031008
1202E	PH0x3x60-PH1x4,5x80	PH2x6x100-PH3x8x150 mm			

Icon	Icon	Icon	Icon	Icon	Icon
1203E/D8P	2,5x50-3x75-4x100	5,5x100-6,5x150 mm	44,50	1	012031018
1202E	PH0x60-PH1x80-PH2x100 mm				

Icon	Icon	Icon	Icon	Icon	Icon
1203E/D10	0,4x2,5x50-0,5x3x75	0,8x4x100-1,0x5,5x100	64,50	1	012031010
1201E	1,2x6,5x150-1,2x8x150 mm				
1202E	PH0x3x60-PH1x4,5x80	PH2x6x100-PH3x8x150 mm			

Icon	Icon	Icon	Icon	Icon	Icon
1203E/D10N	0,4x2,5x50-0,5x3x75-0,8x4x100-1,0x5,5x150-1,2x6,5x150 mm	56,50	1	012031019	
1201E	0,8x4x30 mm				
1202E	PH0x3x60 - PH1x4,5x80 - PH2x6x100 mm				
1202EN	PH1x4,5x30 mm				

1203E/S



Icon	Icon	Icon	Icon	Icon	Icon
1203E/S8	2,5x50-3x75-4x100	5,5x125-6,5x150 mm	44,50	1	012031009
1202E	PH0x3x60-PH1x4,5x80	PH2x6x100 mm			

Icon	Icon	Icon	Icon	Icon	Icon
1203E/S10	0,4x2,5x50-0,5x3x75	0,8x4x125-1,0x5,5x150	65,00	1	012031021
1202E	1,2x6,5x150-1,2x8x150 mm	PH0x3x60-PH1x4,5x80			
	PH2x6x100-PH3x8x150 mm				

1204E

giravite per viti senza testa con intaglio



ISO 2380

SxDxL mm	L1 mm	€	Icon	Icon	Icon
0,4x2,5x60	156	4,25	5	012041003	
0,6x3x75	175	4,35	5	012041006	
0,5x3x100	196	4,45	5	012041009	
0,8x4x100	196	5,00	5	012041012	
0,8x4x125	233	5,25	5	012041015	
1x5x125	234	6,15	5	012041018	
1x5x150	258	6,65	5	012041021	
1,2x6,5x150	270	7,25	5	012041024	



Icon	Icon	Icon	Icon	Icon	Icon
1204E/S5	0,4x2,5x60-0,5x3x100	0,8x4x100-1x5x125	27,00	1	012041205
	1,2x6,5x150 mm				

1204EL

giravite per viti senza testa con intaglio tipo lungo

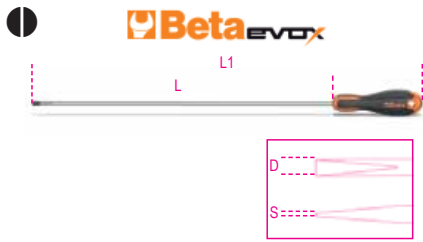

ISO 2380

SxDxL mm	L1 mm	€		
0,5x2,5x200	300	6,30	3	012041303
0,5x3x300	400	7,50	3	012041306
0,8x4x400	508	9,20	3	012041309
1x5x400	508	9,85	3	012041315
1,2x6,5x400	519	12,60	3	012041318

1205E/ES

chiavi maschio esagonale con impugnatura



mm	L mm	L1 mm	€		
1,5	100	200	5,35	3	012051315
2	100	200	5,50	3	012051320
2,5	100	200	5,55	3	012051325
3	100	200	5,75	3	012051330
4	100	208	6,60	3	012051340
5	100	219	7,90	3	012051350
6	125	244	8,10	3	012051360
8	150	277	10,80	2	012051380



1205E/ES-S8	€		
1,5-2-2,5-3-4-5-6-8 mm	55,50	1	012051408

1206E/BP

chiavi maschio esagonale ad estremità sferica con impugnatura



mm	L mm	L1 mm	Ø mm	€		
2	100	198	2,5	6,00	3	012061320
2,5	100	198	3,0	6,10	3	012061325
3	100	198	3,5	6,20	3	012061330
4	100	209	5,0	6,95	3	012061340
5	100	220	6,0	8,35	3	012061350
6	125	245	7,0	8,60	3	012061360
8	150	287	9,5	11,50	2	012061380



1206E/BP-S7	€		
2-2,5-3-4-5-6-8 mm	53,50	1	012061407

1207E/TX

chiavi maschio con impugnatura per viti con impronta Torx®



	L mm	L1 mm	Ø mm	€		
T5	50	150	3	6,40	5	012071005
T6	60	156	4	6,80	5	012071006
T7	60	156	4	6,95	5	012071007
T8	60	156	4	7,05	5	012071008
T9	60	156	4	7,40	5	012071009
T10	80	189	5	8,35	5	012071010
T15	80	189	5	8,45	5	012071015
T20	100	209	5	8,60	5	012071020
T25	100	209	5	8,85	5	012071025
T27	100	220	6	9,40	5	012071027
T30	100	220	6	9,50	5	012071030
T40	130	262	7	11,30	2	012071040
T45	130	262	8	12,40	2	012071045



1207E/TX-D7	€		
T6-T8-T10-T15-T20-T25-T30	57,50	1	012071207

1207E/TX-S13	€		
T5-T6-T7-T8-T9-T10-T15-T20-T25-T27-T30-T40-T45	111,50	1	012071213

1208E/RTX

chiavi maschio con impugnatura per viti con impronta Tamper Resistant Torx®



	L mm	L1 mm	Ø mm	€		
T9	60	156	4	7,50	5	012081009
T10	80	189	5	8,35	5	012081010
T15	80	189	5	8,85	5	012081015
T20	100	209	5	9,00	5	012081020
T25	100	209	5	9,20	5	012081025
T27	100	220	6	10,00	5	012081027
T30	100	220	6	10,50	5	012081030
T40	130	262	7	12,50	2	012081040



1208E/RTX-D7	€		
T9-T10-T15-T20-T25-T27-T30	63,50	1	012081207

1209E/PZ

giravite per viti con impronta a croce Pozidriv®-Supadriv®



UNI-ISO 8764

PZ	L mm	L1 mm	€		
0	60	156	5,00	5	012091000
1	80	189	6,50	5	012091003
2	100	220	8,35	5	012091006
3	150	282	12,80	3	012091009
4	200	327	14,00	3	012091012



1209E/PZ-S4	€		
PZ0-PZ1-PZ2-PZ3	32,50	1	012091204

1209EN/PZ

giravite per viti con impronta a croce Pozidriv®-Supadriv® tipo cortissimo



ISO 8764

PZ	L mm	L1 mm	€		
1	30	87	5,95	3	012091103
2	30	87	6,30	3	012091106

Beta **EVOX-E**

GIRAVITE ELETTRICO BETA EVOX-E

Il giravite elettrico Beta Evox-E è l'utensile ideale per svolgere lavori di alta precisione con il minimo sforzo e la massima rapidità.



PRATICITÀ

Le dimensioni ridotte semplificano l'avvitamento in spazi ristretti e il LED frontali garantiscono un'ottima visibilità del punto di lavoro.

ERGONOMIA

L'impugnatura si adatta perfettamente al palmo della mano, favorendo una presa comoda e salda.

1/4



USB-C



Durata

La batteria al litio 3,7V da 2300mAh garantisce una lunga durata per avvitare fino a 1.000 viti con un solo ciclo di carica.

È disponibile in due varianti:

- giravite elettrico 1210E/GE con inserti



- giravite elettrico 1211E/GE con inserti isolati 1000V



1000 V



1210E/GE

giravite elettrico Evox-E



L

mm

150

€

176,00



1 0121100701

1211E/GE

giravite elettrico Evox-E



L

mm

150

€

187,50



1 0121100701



1229LP/A6

1,2-1,4-1,8-2-2,4-3 mm

€

27,00



1 012290300

1229LPH/A6

serie di 6 microgiravite
1229LP - 1229PH



1229LPH/A6

1229LP 1,4-2,0-2,4-3 mm
1229PH PH0-PH1

€

27,00



1 012290310

1236B

giravite a squadra per viti a testa con intaglio

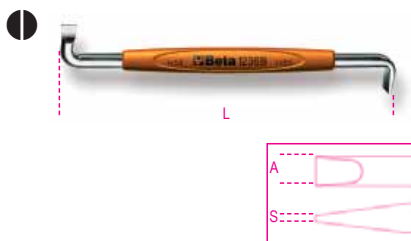

UNI 7079 DIN 5200

SxA mm	L mm	€		
0,8x4	100	7,65	5	012360201
1x5,5	125	8,95	5	012360202
1,2x8	150	11,10	5	012360204

1238B

giravite a squadra per viti con impronta a croce Phillips®



UNI 7083 DIN 5208

PH	L mm	€		
1-2	125	9,10	5	012380201
3-4	200	14,80	5	012380203

1241

giravite a battere per viti a testa con intaglio

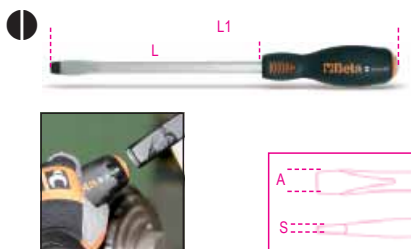

ISO 2380

SxAxL mm	L1 mm	€		
1x5,5x100	202	12,00	5	012410039
1,2x6,5x125	240	13,30	5	012410050
1,2x8x150	268	16,20	3	012410057
1,6x10x175	300	20,30	2	012410065
1,6x10x200	325	20,70	2	012410066
2,0x12x200	325	21,80	2	012410067
2,5x14x250	375	23,90	2	012410076



1242

giravite a battere per viti con impronta a croce Phillips®



UNI/ISO 8764

PHxDxL mm	L1 mm	€		
1x4,5x100	202	11,80	5	012420209
2x6x100	215	14,00	5	012420218
3x8x150	268	17,90	3	012420221
4x11x200	325	23,30	2	012420224

1243LP/D6

serie di 6 giravite a battere per viti a testa con intaglio



	€		
1243LP/D6	107,50	1	012430016
1241			1x5,5x100-1,2x6,5x125 3x8x150-1,6x10x175 2,0x12x200-2,5x14x250 mm

1243/D7

serie di 7 giravite a battere



	€		
1243/D7	106,00	1	012430017
1241			1x5,5x100-1,2x6,5x125 1,2x8x150-1,6x10x200 mm
1242			PH1x4,5x100-PH2x6x100 PH3x8x150 mm

1243/S11

serie di 11 giravite a battere



	€		
1243/S11	195,00	1	012430021
1241			1x5,5x100-1,2x6,5x125 3x8x150-1,6x10x175 1,6x10x200-2,0x12x200 2,5x14x250 mm
1242			PH1x4,5x100-PH2x6x100 PH3x8x150-PH4x11x200 mm

1250

giravite prensili per viti a testa con intaglio

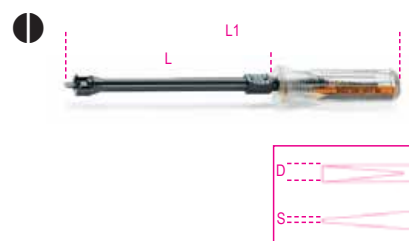

SxDxL mm	L1 mm	€		
0,5x3x125	190	17,10	5	012500030
0,6x4x125	225	18,40	5	012500040
0,7x5x150	255	21,70	5	012500050

1251

giravite prensili per viti con impronta a croce Phillips®



PHxDxL mm	L1 mm	€		
0x4x125	225	19,20	5	012510000
1x5x125	225	22,20	5	012510010
2x6x175	280	25,50	5	012510020

1252/S5

	€		
1252/S5	105,00	1	012520001
1250			0,5x3x125-0,6x4x125 0,7x5x150 mm
1251			PH1x5x150-PH2x6x175 mm

1253

giravite cercafase 150/250V

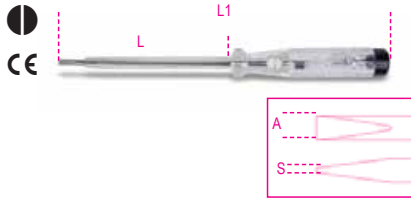

SxAxL mm	L1 mm	€	5	012530001
0,5x3,5x100	190	10,30		

1253A

giravite cercafase 125/250V
doppio isolamento



SxAxL mm	L1 mm	€	5	012530010
0,5x3x15	150	7,30		

1254

giravite provacircuito 6÷24V

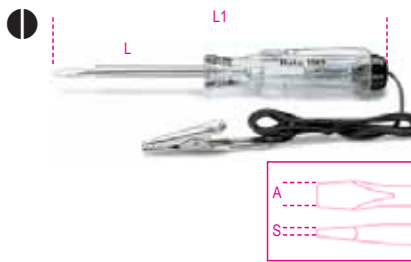

SxAxL mm	L1 mm	€	5	012540001
0,5x3x44	123	11,30		

1256/C36-2

microgiravite con 36 inserti intercambiabili
da 4 mm e prolunga magnetica



1256/C36-2	€	5	012560100
	72,50		

	1256TX	T3 - T4 - T5 - T6 - T7 T8 - T9 - T10 - T15
	1256RTX	T6 - T7 - T8 - T9 - T10
	1256LP	0,8 - 1,2 - 1,5 - 1,8 - 2 - 2,5 3 - 3,5 - 4 mm
	1256PE	0,7 - 0,9 - 1,3 - 1,5 - 2 mm
	1256PH	PH000 - PH00 - PH0 - PH1
	1256PZ	PZ000 - PZ00 - PZ0 - PZ1
	1256/20	
	1256/30	
130x60x35 mm - 200 g		

1256LP

inserti 4 mm
per viti a testa con intaglio

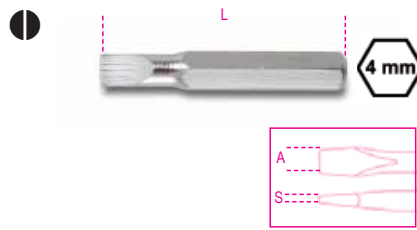

SxA mm	L mm	€	5	012560001
0,25x0,8	27	1,41		
0,25x1,2	27	1,41		
0,3x1,5	27	1,41		
0,35x1,8	27	1,41		
0,4x2,0	27	1,41		
0,4x2,5	27	1,41		
0,5x3,0	27	1,41		
0,6x3,5	27	1,41		
0,8x4,0	27	1,41		

1256PH

inserti 4 mm
per viti con impronta Phillips®



PH	L mm	€	5	012560011
000	27	1,41		
00	27	1,41		
0	27	1,41		
1	27	1,41		

1256PZ

inserti 4 mm
per viti con impronta Pozidriv® - Supradriv®



PZ	L mm	€	5	012560061
000	27	1,41		
00	27	1,41		
0	27	1,41		
1	27	1,41		

1256PE

inserti 4 mm
per viti con impronta esagonale



mm	L mm	€	5	012560021
0,7	27	1,41		
0,9	27	1,41		
1,3	27	1,41		
1,5	27	1,41		
2,0	27	1,41		

1256TX

inserti 4 mm
per viti con impronta Torx®



T	L mm	€	5	012560041
T3	27	1,47		
T4	27	1,47		
T5	27	1,47		
T6	27	1,47		
T7	27	1,47		
T8	27	1,47		
T9	27	1,47		
T10	27	1,47		
T15	27	1,47		

1256RTX

inserti 4 mm
per viti con impronta Tamper Resistant Torx®



T	L mm	€	5	012560051
T6	27	1,76		
T7	27	1,76		
T8	27	1,76		
T9	27	1,76		
T10	27	1,76		

1256/20

prolunga con attacchi esagonali
maschio e femmina da 4 mm



1256/20	€	5	012560092
	8,85		

1256/30

portainseri da 4 mm con impugnatura



L mm	€	5	012560097
110	10,50		

1257LP



microgiravite per viti senza testa
con intaglio



SxD mm	L mm	€	5	012570012
0,25x1,2	60	5,60		
0,23x1,5	60	5,60		
0,3x1,8	60	5,60		
0,4x2	60	5,60		
0,4x2,5	60	5,60		

SxD mm	L mm	€		
0,5x3	60	5,60	5	012570030
0,6x3,5	60	5,60	5	012570035
0,8x4	60	5,60	5	012570040



1257LP/S8	€		
0,2x1,2-0,25x1,5	70,50	1	012570200
0,3x1,8-0,4x2-0,4x2,5			
0,5x3-0,6x3,5-0,8x4 mm			

1257PH

microgiravite per viti
con impronta a croce Phillips®



PH	L mm	€		
00	60	5,60	5	012570060
0	60	5,60	5	012570063
1	60	5,60	5	012570066

1257LPH/S8



1257LPH/S8	€		
1257PH PH00-PH0-PH1	70,50	1	012570210
1257LP 0,4x2-0,4x2,5-0,5x3			
0,6x3,5-0,8x4 mm			

1257ES



microgiravite a chiave maschio
esagonale



mm	L mm	€		
0,9	60	6,30	5	012570045
1,3	60	6,30	5	012570046
1,5	60	6,30	5	012570047
2	60	6,30	5	012570048
2,5	60	6,30	5	012570049
3	60	6,30	5	012570050

1257ESB/S8



1257ESB/S8	€		
1257ES 0,9-1,3-1,5-2-2,5-3 mm	80,00	1	012570230
1257BE 4-5 mm			



1257TX

microgiravite a chiave maschio
per viti con impronta Torx®



T	L mm	€		
T5	60	6,65	5	012570075
T6	60	6,65	5	012570076
T7	60	6,65	5	012570077
T8	60	6,65	5	012570078
T9	60	6,65	5	012570079
T10	60	6,65	5	012570080
T15	60	6,65	5	012570081
T20	60	6,65	5	012570082



1257TX/S8	€		
T5-T6-T7-T8	78,50	1	012570220
T9-T10-T15-T20			

1257BE

microgiravite
chiave bussola esagonale



mm	L mm	€		
3,2	60	8,30	5	012570085
4	60	8,30	5	012570086
5	60	8,30	5	012570087
5,5	60	8,30	5	012570088



 **Beta**



Il giravite Beta Grip nascono dalla pluriennale esperienza di Beta nella progettazione di giravite e dalla stretta collaborazione con i meccanici dei team delle competizioni motoristiche. Per raggiungere i più alti obiettivi di ergonomia, resistenza e qualità dei materiali sono state utilizzate nuove ed esclusive soluzioni tecniche in grado di soddisfare anche le richieste dei professionisti più esigenti.

- La lama è realizzata con un acciaio speciale a elevato tenore di silicio, cromo e vanadio per garantire maggiori prestazioni in termini di resistenza alla torsione e flessione. La cromatura è di tipo satinato antiriflesso.
- La **geometria della punta** è stata studiata per garantire un accoppiamento perfetto tra la lama e la testa della vite. La finitura fosfatata evita l'ossidazione della punta e ne conserva la precisione dei profili.
- La **texture** è stata realizzata prendendo di ispirazione il battistrada dei pneumatici Racing, studiati per massimizzare la tenuta su diverse tipologie di terreno. Permette dunque un'efficace presa sul cacciavite in qualsiasi condizione di lavoro, migliorando la precisione e il controllo nella fase di centraggio della punta sulla vite.



1260

giravite per viti a testa con intaglio



ISO 2380

SxAxL mm	L1 mm	Ø mm	€	🔩	📦
0,4x2,5x50	150	2,5	5,75	5	012600003
0,4x2,5x75	175	2,5	6,00	5	012600006
0,5x3x75	175	3,0	6,15	5	012600009
0,5x3x100	200	3,0	6,35	5	012600012
0,6x3,5x75	175	3,5	6,55	5	012600018
0,6x3,5x100	200	3,5	6,65	5	012600021
0,8x4x100	208	4,0	7,25	5	012600030
0,8x4x125	233	4,0	7,55	5	012600033
0,8x4x150	258	4,0	7,85	5	012600036
1x5,5x100	208	5,0	8,30	5	012600039
1x5,5x125	233	5,0	8,50	5	012600040
1x5,5x150	258	5,0	9,25	5	012600042
1,2x6,5x100	219	6,0	10,00	5	012600048
1,2x6,5x125	244	6,0	10,40	5	012600050
1,2x6,5x150	269	6,0	10,80	5	012600051
1,2x8x150	277	8,0	13,20	3	012600057
1,2x8x200	327	8,0	13,60	3	012600060
1,6x10x200	327	9,5	16,50	3	012600066
2x12x250	377	10	19,60	3	012600069
2x14x250	377	10	20,70	2	012600073



1260/S6	€	🔩	📦
0,4x2,5x75-0,5x3x75-0,8x4x125 1x5,5x150-1,2x6,5x150-1,2x8x200 mm	53,50	1	012600306

1260N

giravite per viti a testa con intaglio
tipo cortissimo



ISO 2380

SxAxL mm	L1 mm	Ø mm	€	🔩	📦
0,8x4x30	87	4	7,65	5	012600103
1,2x6,5x30	87	6	8,50	5	012600106



1260E

giravite con esagono di manovra
per viti a testa con intaglio



ISO 2380

SxAxL mm	L1 mm	Ø mm	€		
1,2x6,5x150	269	6,0	14,00	3	012600156
1,2x8x175	301	8,0	17,20	3	012600157
1,6x10x200	327	9,5	19,90	2	012600159
2x12x250	377	9,5	23,10	2	012600162

1260MC

giravite per viti a testa con intaglio colorato



SxAxL mm	L1 mm	Ø mm	€		
0,4x2,5x50	150	2,5	6,25	3	012602003
0,6x3,5x75	175	3,5	6,45	3	012602018
0,8x4x100	208	4,0	7,65	3	012602030
1x5,5x150	233	5,0	9,80	5	012602040
1,2x6,5x150	269	6,0	11,30	5	012602051

1262

giravite per viti con impronta a croce Phillips®



UNI/ISO 8764

PHxDxL mm	L1 mm	€		
0x3x60	160	6,15	5	012620003
0x3x100	200	6,50	5	012620006
1x4,5x80	188	8,05	5	012620009
1x4,5x120	228	8,75	5	012620012
2x6x100	219	9,90	5	012620018
2x6x150	269	10,90	5	012620021
3x8x150	277	14,60	3	012620024
4x10x200	327	18,60	3	012620027



1262/S4	€		
PH0x3x60-PH1x4,5x80 PH2x6x100-PH3x8x150 mm	38,50	1	012620304

1262N

giravite per viti con impronta
a croce Phillips®
tipo cortissimo



UNI/ISO 8764

PHxDxL mm	L1 mm	€		
1x4,5x30	87	7,65	5	012620103
2x6x30	87	8,50	5	012620106

1262E

giravite con esagono di manovra
per viti con impronta a croce Phillips®



UNI/ISO 8764

PHxDxL mm	L1 mm	€		
2x6x150	269	14,00	3	012620153
3x8x175	302	17,00	3	012620156
4x10x200	327	21,40	2	012620159

1262L

giravite per viti con impronta
a croce Phillips®, tipo lungo



UNI/ISO 8764-1

PHxDxL mm	L1 mm	€		
0x3x300	400	10,60	3	012620203
1x4,5x300	400	12,70	3	012620205
1x4,5x400	508	14,70	3	012620206
2x6x400	519	19,20	3	012620209

1262MC

giravite per viti con impronta a croce Phillips®
colorato



PHxDxL mm	L1 mm	€		
0x3x60	160	6,45	3	012622003
1x4,5x80	188	8,35	3	012622009
2x6x100	219	10,40	3	012622018

1263/D...

serie giravite



1263/D6	€		
1260	50,50	1	012630006
1262			

0,5x3x75-0,8x4x100
1x5,5x125-1,2x6,5x150 mm
PH1x4,5x80-PH2x6x100 mm



1263/D7	€		
1262	52,00	1	012630017
1264			

PH0x3x60
PH1x4,5x80
PH2x6x100 mm
0,5x2,5x60-0,6x3x100
0,8x4x125-1x5x125 mm



1263/D7PZ	€		
1260	60,50	1	012630007
1269PZ			

0,5x3x75-0,8x4x100
1x5,5x150-1,2x6,5x150 mm
PZ0 - PZ1 - PZ2



1263/D8	€		
1260	62,50	1	012630008
1262			

0,4x2,5x50-0,5x3x75
0,8x4x100-1x5,5x125
1,2x6,5x150 mm
PH0x3x60-PH1x4,5x80
PH2x6x100 mm



1263/D10	€		
1260	80,00	1	012630010
1260N			
1262			
1262N			

0,5x3x75-0,6x3,5x100
0,8x4x125-1x5,5x150
1,2x6,5x150 mm
0,8x4x30
PH0x3x60-PH1x4,5x80
PH2x6x100 mm
PH1x4,5x30

1263/S12

serie di 12 giravite



		€		
1263/S12		114,00	1	012630112
1260	0,4x2,5x50-0,5x3x75 0,6x3,5x100-0,8x4x125 1x5,5x125-1,2x6,5x150 1,2x8x200-1,6x10x200 mm			
1262	PH0x3x60-PH1x4,5x80 PH2x6x100-PH3x8x150 mm			

1263MC/D8

serie 8 giravite colorati



		€		
1263MC/D8		66,50	1	012632008
1260MC	0,4x2,5x50-0,5x3x75 0,8x4x100-1x5,5x125 1,2x6,5x150 mm			
1262MC	PH0x3x60-PH1x4,5x80 PH2x6x100 mm			

1264

giravite per viti senza testa con intaglio
con intaglio



SxDxL mm	L1 mm	€		
0,5x2,5x60	160	5,75	5	012640003
0,6x3x75	175	6,15	5	012640006
0,6x3x100	200	6,35	5	012640009
0,8x4x100	208	7,25	5	012640012
0,8x4x125	233	7,55	5	012640015
1x5x125	233	8,50	5	012640018
1x5x150	258	8,95	5	012640021
1,2x6,5x150	269	10,80	5	012640024



		€		
1264/S5		38,50	1	012640305
0,5x2,5x60-0,6x3x75 0,8x4x100-1x5x125-1,2x6,5x150 mm				

1264L

giravite per viti senza testa con intaglio
tipo lungo



SxDxL mm	L1 mm	€		
0,5x2,5x200	300	8,60	3	012640203
0,6x3x300	400	10,10	3	012640206
0,8x4x400	508	13,20	3	012640209
1x5x400	508	14,70	3	012640215
1,2x6,5x400	519	17,90	3	012640218

1265ES

chiavi maschio esagonale
con impugnatura



mm	L mm	L1 mm	€		
1,5	100	200	7,05	3	012650015
2	100	200	7,20	3	012650020
2,5	100	200	7,45	3	012650025
3	100	200	7,85	3	012650030
4	100	208	8,65	3	012650040
5	100	219	10,00	3	012650050
6	125	244	11,30	3	012650060
8	150	277	15,00	2	012650080



		€		
1265ES/S8		74,50	1	012650308
1,5-2-2,5-3-4-5-6-8 mm				

1266BP

chiavi maschio esagonale
ad estremità sferica con impugnatura



mm	L mm	L1 mm	€		
2	100	200	7,65	3	012660020
2,5	100	200	7,95	3	012660025
3	125	225	8,30	3	012660030
4	125	233	9,25	3	012660040
5	120	239	10,80	3	012660050
6	140	259	12,50	3	012660060
8	160	287	15,70	2	012660080
10	160	287	18,90	2	012660100



		€		
1266BP/S8		91,00	1	012660308
2-2,5-3-4-5-6-8-10 mm				

1267TX

chiavi maschio con impugnatura per viti con
impronta Torx®



Ø	L mm	L1 mm	Ø mm	€		
T5	50	150	3	8,60	5	012670005
T6	50	150	3	8,95	5	012670006
T7	50	150	3	9,25	5	012670007
T8	60	160	3	9,70	5	012670008
T9	60	167	4	10,10	5	012670009
T10	80	188	4	10,50	5	012670010
T15	80	188	4	11,10	5	012670015
T20	100	208	4,5	11,70	5	012670020
T25	100	208	5	12,70	5	012670025
T27	115	234	6	13,20	5	012670027
T30	115	234	6	13,90	5	012670030
T40	130	257	7	16,10	2	012670040
T45	130	257	8	17,70	2	012670045



1267TX/D7
T6-T8-T10-T15
T20-T25-T30

€ 78,50 1 012670307



1267TX/S13
T5-T6-T7-T8-T9
T10-T15-T20-T25
T27-T30-T40-T45

€ 153,50 1 012670312

1267MC/TX

chiavi maschio con impugnatura per viti con impronta Torx® colorate



Ø	L mm	L1 mm	Ø mm	€	U	PC
T6	50	150	3	9,45	5	012672006
T8	60	160	3	10,00	5	012672008
T10	80	188	4	11,00	5	012672010
T15	80	188	4	11,70	5	012672015
T20	100	208	4,5	12,50	5	012672020
T25	100	208	5	13,10	3	012672025
T30	115	234	6	14,40	3	012672030



1267MC/TX-D7
T6-T8-T10-T15
T20-T25-T30

€ 82,00 1 012672307

1268RTX

chiavi maschio con impugnatura per viti con impronta Tamper Resistant Torx®



Ø	L mm	L1 mm	Ø mm	€	U	PC
T9	60	167	4,0	11,00	3	012680009
T10	80	188	4,0	11,40	3	012680010
T15	80	188	4,0	11,70	3	012680015
T20	100	208	4,5	12,70	3	012680020
T25	100	208	5,0	13,00	3	012680025
T27	115	234	6,0	13,90	3	012680027
T30	115	234	6,0	14,10	3	012680030
T40	130	257	7,0	16,30	2	012680040



1268RTX/S8
T9-T10-T15-T20
T25-T27-T30-T40

€ 104,00 1 012680307

1269PZ

giravite per viti con impronta a croce Pozidriv®-Supadriv®



UNI/ISO 8764

PZ	L mm	L1 mm	€	U	PC
0	60	160	7,00	5	012690000
1	80	188	9,10	5	012690001
2	100	219	11,00	5	012690002
3	150	277	15,70	3	012690003
4	200	327	20,10	3	012690004



1269PZ/S4
PZ0-PZ1-PZ2-PZ3

€ 43,00 1 012690304

1269N/PZ

giravite per viti con impronta a croce Pozidriv®-Supadriv® tipo cortissimo



UNI/ISO 8764

PZ	L mm	L1 mm	€	U	PC
1	30	87	7,65	5	012690011
2	30	87	8,50	5	012690012

1281BG

impugnatura porta lame giravite



L mm	Ø mm	€	U	PC
118	10	12,90	5	012810280

1281PM

portainseri magnetico ad innesto rapido



L mm	€	U	PC
165	22,00	5	012810292

1281PB

portabussole quadro maschio 1/4"



L mm	€	U	PC
175	17,60	5	012810293

1281LP

giravite bivalenti per viti a testa con intaglio



Model	€	U	PC
1281LP/1 0,8x4-1,2x6,5 mm	11,30	5	012810302
1281LP/2 1x5,5-1,2x6,5 mm	11,30	5	012810304

1281PH

giravite bivalenti per viti con impronta a croce Phillips®



PH	€	Impugnatura	Accessori
1-2	11,30	5	012810310
2-3	11,30	5	012810312

1281LPH

giravite bivalenti per viti a testa con intaglio e Phillips®



	€	Impugnatura	Accessori
1281LPH/1 PH0-0,8x4 mm	11,30	5	012810321
1281LPH/2 PH1-1x5,5 mm	11,30	5	012810322
1281LPH/3 PH2-1,2x6,5 mm	11,30	5	012810323

1281PZ

giravite bivalenti per viti con impronta a croce Pozidriv®-Supadriv®



PZ	€	Impugnatura	Accessori
1-2	11,30	5	012810330
2-3	11,30	5	012810332

1281PE

chiavi maschio esagonale bivalenti con un'estremità sferica



mm	€	Impugnatura	Accessori
2,5	11,10	5	012810342
3	11,10	5	012810343
4	11,10	5	012810344
5	11,10	5	012810345
6	11,10	5	012810346

1281TX

chiavi maschio bivalenti per viti con impronta Torx®



	€	Impugnatura	Accessori
1281TX/1 T6-T8	12,40	5	012810349
1281TX/2 T7-T9	12,40	5	012810350
1281TX/3 T10-T15	12,40	5	012810351
1281TX/4 T20-T25	12,40	5	012810352
1281TX/5 T30-T40	12,40	5	012810353

1281RTX

chiavi maschio bivalenti per viti con impronta Tamper Resistant Torx®



	€	Impugnatura	Accessori
1281RTX/3 T10-T15	12,60	5	012810361
1281RTX/4 T20-T25	12,60	5	012810362
1281RTX/5 T30-T40	12,60	5	012810363

1281BG/A9

assortimento di 9 giravite bivalenti e 1 impugnatura di manovra, in astuccio



1281BG/A9	€	Impugnatura	Accessori
	131,50	1	012810520

1281BG	
1281LPH/1	PH0-0,8x4 mm
1281LPH/2	PH1-1x5,5 mm
1281LPH/3	PH2-1,2x6,5 mm
1281PZ/1	PZ1-PZ2
1281PE	2,5 mm
1281PE	3 mm
1281PE	4 mm
1281PE	5 mm
1281PE	6 mm

1281BG-TX/A8

assortimento di 8 giravite bivalenti e 1 impugnatura di manovra, in astuccio



1281BG-TX/A8	€	Impugnatura	Accessori
	126,50	1	012810530

1281BG	
1281LPH/1	PH0-0,8x4 mm
1281LPH/2	PH1-1x5,5 mm
1281LPH/3	PH2-1,2x6,5 mm
1281TX/1	T6-T8
1281TX/2	T7-T9
1281TX/3	T10-T15
1281TX/4	T20-T25
1281TX/5	T30-T40

1281BG/B28NA

assortimento di 16 giravite bivalenti, 9 chiavi a bussola 1/4", 2 accessori e 1 impugnatura di manovra, in busta di poliestere resistente



1281BG/B28NA	€	Impugnatura	Accessori
	291,00	1	012810511

900	
1281BG	4 - 4,5 - 5 - 5,5 - 6 - 7 - 8 - 9 - 10 mm
1281PB	1/4"
900/25	
1281LP/1	0,8x4 - 1,2x6,5 mm
1281LP/2	1,0x5,5 - 1,2x6,5 mm
1281PH/1	PH1 - PH2
1281PH/2	PH2 - PH3
1281PZ/1	PZ1 - PZ2
1281PZ/2	PZ2 - PZ3
1281PE	2,5 - 3 - 4 - 5 - 6 mm
1281TX/1	T6 - T8
1281TX/2	T7 - T9
1281RTX/3	T10 - T15
1281RTX/4	T20 - T25
1281RTX/5	T30 - T40

2002/BV7-ZIP	€	Impugnatura	Accessori
	20,80	1	020020060

I giravite BetaMax presentano molteplici caratteristiche tecniche per agevolare le operazioni di lavoro.

- L'impugnatura si ispira alla sezione triangolare che offre il vantaggio di un ottimale avvitamento, infatti la ripresa della manovra avviene con successione di 120°, in conformità alla massima rotazione ottenibile dal polso.
- Il design assicura una notevole ergonomia, sia in fase di avvitamento rapido che di serraggio.
- La punta priva di cromatura garantisce un perfetto accoppiamento con la vite ed è protetta dall'ossidazione con un trattamento di fosfatazione.



1290

giravite per viti a testa con intaglio

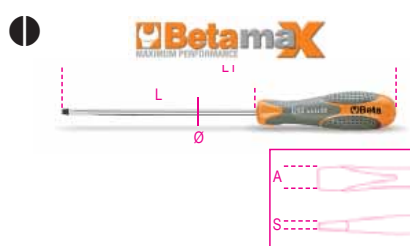

ISO 2380

SxAxL mm	L1 mm	Ø mm	€		
0,4x2,5x50	146	2,5	7,40	5	012900003
0,4x2,5x75	171	2,5	7,65	5	012900006
0,5x3x75	171	3,0	7,80	10	012900009
0,5x3x100	196	3,0	8,20	10	012900012
0,6x3,5x75	171	3,5	8,85	10	012900018
0,6x3,5x100	196	3,5	9,00	10	012900021
0,8x4x100	196	4,0	9,10	10	012900030
0,8x4x125	221	4,0	9,35	10	012900033
0,8x4x150	246	4,0	10,00	10	012900036
1x5,5x100	209	5,0	10,20	10	012900039
1x5,5x150	259	5,0	11,30	10	012900042
1,2x6,5x100	220	6,0	12,70	10	012900048
1,2x6,5x150	270	6,0	13,40	10	012900051
1,2x8x150	282	7,0	16,80	3	012900057
1,2x8x200	332	7,0	17,80	3	012900060
1,6x10x200	332	8,0	20,90	3	012900066
2x12x250	382	10	28,00	2	012900069

1290/S

serie giravite



	€		
1290/S5	58,50	1	012900305

1290 0,5x3x75-0,8x4x100 -1x5,5x150
1,2x6,5x150 -1,2x8x150 mm

	€		
1290/S9X	109,50	1	012900319

1290 0,4x2,5x75 - 0,5x3,5x100
0,8x4x125 - 1x5,5x150
1,2x6,5x150 - 1,2x8x200
1,6x10x200 mm
1290N 0,8x4x30 -1,2x6,5x30 mm

1290N

giravite per viti a testa con intaglio
tipo cortissimo



ISO 2380

SxAxL mm	L1 mm	Ø mm	€		
0,8x4x30	86	4	9,60	5	012900103
1,2x6,5x30	86	6	10,70	5	012900106

1292

giravite per viti
con impronta a croce Phillips®



UNI/ISO 8764

PHxDxL mm	L1 mm	€		
0x3x60	156	7,05	10	012920003
0x3x100	196	8,05	5	012920006
1x4,5x80	189	9,70	10	012920009
1x4,5x120	229	10,80	10	012920012
2x6x100	220	12,90	10	012920018
2x6x150	270	13,80	10	012920021
3x8x150	282	17,60	3	012920024
4x10x200	332	24,30	3	012920027



	€		
1292/S4 PH0x3x60-PH1x4,5x80 PH2x6x100-PH3x8x150 mm	47,00	1	012920304

1292N

giravite per viti con impronta
a croce Phillips®
tipo cortissimo



UNI/ISO 8764

PHxDxL mm	L1 mm	€		
1x4,5x30	86	9,20	5	012920103
2x6x30	86	10,10	5	012920106

1292L

giravite per viti con impronta
a croce Phillips®, tipo lungo

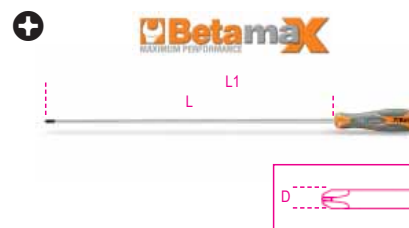

UNI/ISO 8764-1

PHxDxL mm	L1 mm	€		
0x3x300	396	15,70	3	012920203
1x4,5x400	509	19,40	3	012920206
2x6x400	520	23,80	3	012920209

1293/D...

serie giravite

Betamax
MAXIMUM PERFORMANCE



1293/D6 € 63,00 1 012930401

1290 0,6x3,5x75-1x5,5x150
1,2x6,5x150 mm
1292 PH0x3x60 -PH1x4,5x80
PH2x6x100 mm

1293/D8 € 88,00 1 012930403

1290 0,5x3x75-0,8x4x100
1x5,5x150-1,2x6,5x150
1,2x8x150 mm
1292 PH0x3x60 -PH1x4,5x80
PH2x6x100 mm

1293/S...

serie giravite

Betamax
MAXIMUM PERFORMANCE



1293/S8 € 78,50 1 012930208

1290 2,5x50-3x75-4x100-5,5x150
6,5x150 mm
1292 PH0x3x60 -PH1x4,5x80
PH2x6x100 mm

1293/S10 € 125,00 1 012930201

1290 0,4x2,5x50 -0,6x3,5x100
1x5,5x100-1,2x6,5x150
1,2x8x150-1,6x10x200 mm
1292 PH0x3x60 -PH1x4,5x80
PH2x6x100-PH3x8x150 mm

1293/S12 € 136,00 1 012930203

1290 0,5x3x75-0,8x4x125
1x5,5x150-1,2x6,5x150
1,2x8x200 mm
1290N 0,8x4x30 mm
1292 PH0x3x60 -PH1x4,5x80
PH2x6x100-PH3x8x150 mm
1292N PH1x4,5x30-PH2x6x30 mm

1293/S7 € 64,50 1 012930207

1292 PH0x3x60 -PH1x4,5x80
PH2x6x100 mm
1294 0,5x2,5x60-0,6x3x75
0,8x4x100-1x5x125 mm



1293ES

chiavi maschio esagonale
con impugnatura



mm	L mm	L1 mm	Ø mm	€	Impugnatura	Articolo
2	100	196	3	10,00	5	012930001
2,5	100	196	4	10,00	5	012930002
3	100	196	4	10,30	5	012930003
4	100	196	5	11,60	5	012930004
5	100	209	6	12,90	5	012930005
6	125	245	7	14,60	5	012930006
8	150	282	10	19,40	2	012930008



1293ES/S7 € 89,00 1 012930057

2-2,5-3-4-5-6-8 mm

1293BP

chiavi maschio esagonale
ad estremità sferica con impugnatura



mm	L mm	L1 mm	€	Impugnatura	Articolo
2	100	196	10,10	5	012930501
2,5	100	196	10,10	5	012930502
3	100	196	10,40	5	012930503
4	100	196	11,60	5	012930506
5	100	209	12,90	5	012930509
6	125	245	14,90	5	012930512
8	150	282	20,30	2	012930515



1293BP/S7 € 90,50 1 012930558

2-2,5-3-4-5-6-8 mm

1294

giravite per viti senza testa
con intaglio



SxDxL mm	L1 mm	€	Impugnatura	Articolo
0,5x2,5x60	156	6,90	5	012940003
0,6x3x75	171	7,30	5	012940006
0,6x3x100	196	7,50	5	012940009
0,8x4x100	196	9,10	5	012940012
0,8x4x150	246	11,90	5	012940015
1x5x125	234	11,40	5	012940018
1,2x6,5x150	282	13,50	5	012940027



1294/S5 € 48,50 1 012940305

0,5x2,5x60-0,6x3x100
0,8x4x100-1x5x125
1,2x6,5x150 mm

1294L

giravite per viti senza testa con intaglio
tipo lungo

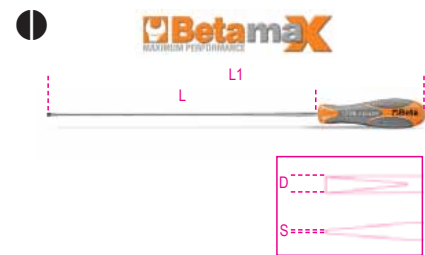

SxDxL mm	L1 mm	€	Impugnatura	Articolo
0,6x3x300	396	15,10	3	012940206
0,8x4x400	496	17,80	3	012940209
1x5x400	509	21,80	3	012940215
1,2x6,5x400	532	24,40	3	012940218

1295

giravite a percussione



1295 € 64,50 1 012950001

L mm 130

Beta
Quality tools

1295/C14

giravite a percussione
con 14 inserti e bussola portainseri



1295/C14 € 169,50 1 012950108

	866LP	1,2x6,5 - 1,6x10 mm
	866PH	PH2 - PH3
	866PZ	PZ2 - PZ3
	866PE	5 - 6 mm
	866TX	T27 - T30 - T40 - T45 - T50 - T55
	895/6	□ 1/2 - ○ 5/16
	1295	■ 1/2

170x100x35 mm - 1,3 kg

1297TX

chiavi maschio con impugnatura
per viti con impronta Torx®



Ø	L mm	L1 mm	Ø mm	€		
T6	50	146	3,0	13,10	5	012970006
T7	50	146	3,0	13,30	5	012970007
T8	60	156	3,0	13,40	5	012970008
T9	60	169	4,0	13,90	5	012970009
T10	80	189	4,0	14,80	5	012970010
T15	80	189	4,0	14,90	5	012970015
T20	100	209	4,5	15,30	5	012970020
T25	100	209	5,0	15,80	5	012970025
T27	115	235	6,0	16,30	5	012970027
T30	115	235	6,0	17,20	5	012970030
T40	130	262	7,0	19,10	2	012970040
T45	130	262	8,0	21,70	2	012970045



1297TX/S12 € 189,00 1 012970312
T6-T7-T8-T9-T10
T15-T20-T25-T27
T30-T40-T45



Betamax
MAXIMUM PERFORMANCE



1297TX/D6 € 94,50 1 012970409
T10-T15-T20
T25-T27-T30

1297TX/L

chiavi maschio con impugnatura
per viti con impronta Torx®, tipo lungo



Ø	L mm	L1 mm	Ø mm	€		
T15	210	319	4,0	16,60	2	012970115
T20	210	319	4,5	17,10	2	012970120
T25	210	319	5,0	17,60	2	012970125
T30	210	330	6,0	18,90	2	012970130
T45	210	342	8,0	20,50	2	012970145



Betamax
MAXIMUM PERFORMANCE

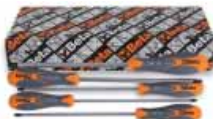

1297TX/L-S5 € 90,50 1 012970325
TX/L15-TX/L20-TX/L25-
TX/L30-TX/L45

1298RTX

chiavi maschio con impugnatura
per viti con impronta
Tammer Resistant Torx®



Ø	L mm	L1 mm	Ø mm	€		
T9	60	169	4,0	15,30	5	012980009
T10	80	189	4,0	15,60	5	012980010
T15	80	189	4,0	16,60	5	012980015
T20	100	209	4,0	16,70	5	012980020
T25	100	209	4,5	17,10	5	012980025
T27	115	235	5,5	18,40	5	012980027
T30	115	235	6,0	19,10	5	012980030
T40	130	262	7,0	20,50	2	012980040



Betamax
MAXIMUM PERFORMANCE



1298RTX/S8 € 139,50 1 012980308
T9-T10-T15-T20
T25-T27-T30-T40

1299PZ

giravite per viti con impronta
a croce Pozidriv®-Supadriv®



UNI/ISO 8764

PZ	L mm	L1 mm	€		
0	60	156	10,20	5	012990000
1	80	189	12,00	5	012990003
2	100	220	16,30	5	012990006
3	150	282	23,60	2	012990009
4	200	332	33,50	2	012990012



Betamax
MAXIMUM PERFORMANCE



1299PZ/S6 € 86,50 1 012990306
1299PZ PZ0-PZ1-PZ2-PZ3
1299N/PZ PZ1-PZ2

1299N/PZ

giravite per viti con impronta
a croce Pozidriv®-Supadriv®
tipo cortissimo



UNI/ISO 8764

PZ	L mm	L1 mm	€		
1	30	86	11,60	5	012990021
2	30	86	12,90	5	012990024

Beta
Quality tools

AUTORIPARAZIONE

I nostri utensili per autoriparazione, usati dai professionisti più esigenti, sono sviluppati e prodotti per soddisfare gli standard più elevati al mondo e testati continuamente nelle condizioni di utilizzo più stressanti.

Da oltre 50 anni, siamo orgogliosamente a fianco dei più grandi campioni, che ci aiutano a migliorare costantemente i nostri prodotti e ne confermano il livello di qualità più assoluta.

Gli utensili dedicati all' autoriparazione si trovano in queste sezioni:

Diagnostica	da 1438 a 1499 da 1758VT a 1760TMC
Motore	da 955 a 989A da 1438 a 1499
Olio e filtri	da 1438 a 1499 da 1877 a 1885
Impianto elettrico	da 1438 a 1499
Avviatori	da 1498BC/12 a 1498/40A
Trasmissione	da 1438 a 1499
Sospensioni	da 1549 a 1569CP
Freni	da 1438 a 1499
Ruote	da 955 a 989A
Carrozzeria	da 1302 a 1369 da 1763 a 1767A
Altre attrezzature	da 1875LT a 3067
Sollevatori	da 3029/2T a 3067/70-13T



1302

tasso con impugnatura testa tonda convessa e a penna



g 770 € 100,00 1 013020001

1303

tasso a virgola



g 1350 € 75,50 1 013030001

1304

tasso a suola



g 875 € 95,00 1 013040001

1305

tasso curvo



g 1190 € 60,50 1 013050001

1305Z

tasso curvo zigrinato



g 1065 € 71,50 1 013050002

1306

tasso a tacco bombato



g 1040 € 56,50 1 013060001

1307

tasso rettangolare bombato

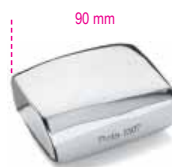

g 1100 € 111,00 1 013070001

1308

tasso ovoidale



g 1100 € 103,50 1 013080001

1310

tasso a rotaia



g 1225 € 64,00 1 013100001

1312

tasso a incudine



g 1220 € 137,00 1 013120001

1314
tasso a teste tonde
convessa e piana



g 760 € 61,00 1 013140001

1326
leva a cazzuola



g 560 € 54,50 1 013260001

1327
leva a cucchiaio
pesante



g 1075 € 76,00 1 013270001

1328
leva a cucchiaio
leggera



g 935 € 69,00 1 013280001

1329
leva curva e piana



g 1800 € 210,50 1 013290001

1330
leva a gomito e piana



g 2125 € 224,50 1 013300001

1331
leva a gola con linguetta in cuoio



g 1100 € 124,50 1 013310001

1335BM
battilamiera con impugnatura
in materiale plastico



g 500 € 36,50 2 013350010

1337/S5
serie di 5 spatoline per carrozzieri in acciaio
inox tipo giapponese



L mm 25-50-75-100-125 € 14,00 1 013370015

1338A - 1338B
portalima con lima
a dentatura radiale, piatta flessibile



	°/1"	L mm	€		
1338A	9	360	103,00	2	013380001
1338B	12	360	108,50	2	013380002

1338
portalima per 1338R



1338 € 56,00 2 013380003

1338R9 - 1338R12
lime di ricambio per 1338A e 1338B



	°/1"	€		
1338R9	9	47,00	2	013380004
1338R12	12	52,50	2	013380005

1342
scalpello extrapiatto
con tagliente diritto



L mm 235 € 32,50 5 013420001

1342PM
scalpello extrapiatto con tagliente diritto
con paramano



L mm 235 L1 mm 118 € 46,00 2 013420002

1342PMR
paramano di ricambio per 1342



1342PMR € 13,40 1 013420003

1343
scalpello piatto con tagliente laterale



L mm 200 € 34,00 5 013430001

1344

coppia di spessimetri per carrozzieri a 10 lame con ventosa di fissaggio

indicati per:

- posizionamento lunotti
- mantenimento della posizione durante i montaggi



1344 € 39,00 1 013440010

1344A/VW

attrezzo per rimozione gancio di fissaggio maniglie Volkswagen



L mm 260 € 17,90 1 013440100

1345

martello con testa tonda convessa e penna legno manico in legno



1345 € 48,00 2 013450010

1351

martello con testa tonda piana e penna sferica manico in legno



1351 € 48,00 2 013510010

1353

martello con testa tonda piana e penna a punta manico in legno



1353 € 48,00 2 013530010

1357Z/45

martelli con teste piane tonda zigrinata e quadra liscia manico in legno



1357Z/45 € 78,50 2 013570045

1359T

martello con testa tonda convessa e penna orizzontale manico in legno



1359 T € 48,00 2 013590010

1360G

martello in gomma morbida antirimbato, per montaggio guarnizioni e componenti delicati

l'estrema morbidezza del battente permette di non danneggiare le parti lavorate, in quanto assorbe l'urto deformandosi



L mm 280 Ø mm 72 € 79,00 1 013600000

1360/K6

martello in alluminio con testa tonda piana, puntali di plastica intercambiabili e bulino

fornito con:
 • 4 puntali di plastica
 • 1 bulino regolabile in 2 differenti lunghezze applicabile al martello



L mm 320 Ø mm 34 € 91,00 1 013600006

1360/KP3

martelli con teste sferiche e penna a punta più punzone, in materiale plastico

Contenuto del kit:

- 1 martello da 210 g con testa Ø 30 mm
- 1 martello da 290 g con testa Ø 40 mm
- 1 punzone da 75 g con punta da 5 mm



1360/KP3 € 87,50 1 013600503

1361/C12

serie di puntali in Teflon® per carrozzeria



1361/C12 € 137,00 1 013610012
 275x160x57 mm

1361/K9

kit 8 leve per tirabolli carrozzeria

il kit comprende:

- leva con testa a palla tonda Ø 31 mm lunghezza 110 cm
- leva con punta lunghezza 62 cm
- leva con punta a coda di balena lunghezza 112 cm
- leva con punta ad uncino lunghezza 27 cm
- leva con testa tonda piatta lunghezza 50 cm
- leva con testa a palla tonda Ø 19 mm lunghezza 52 cm
- leva con testa a coda di balena lunghezza 27 cm
- leva con testa a coda di balena arrotondata lunghezza 28 cm
- borsa in tessuto con manici



1361/K9 € 323,00 1 013610030

1362B

disco in tessuto per riscontro bolli

- superficie interamente rivestita in materiale antigraffio
- fornito in custodia



1362B	Ø mm	€	1	013620011
	755	83,00		

1364SE

supporto estensibile per carrozzeria

caratteristiche tecniche:

- 4 ruote pivotanti, 2 dotate di freno
- pantografo estensibile fino a 1400 mm
- regolabile in altezza fino a 1315 mm
- blocco delle posizioni
- superficie di appoggio rivestita in gomma removibile
- portata massima 226 kg

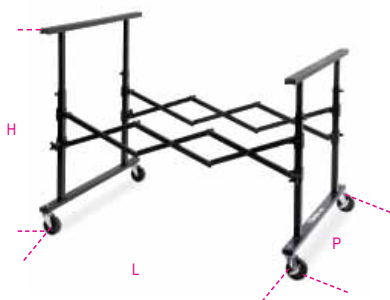

	L mm	H mm	P mm	€	1	013640001
	215÷1400	780÷1315	890	427,00		

1364SV

supporto per carrozzeria con vassoio centrale

caratteristiche tecniche:

- superficie di appoggio rivestita in polietilene
- dimensioni vassoio: 340x845x40 mm
- richiudibile



1364SV	H mm	€	1	013640002
	1000	242,50		

1364SCP

supporto orientabile per carrozzeria

particolarmente idoneo per cofani, parafanghi e portiere dotato di 4 ruote, 2 girevoli con freno orientabile di 180°



1364SCP	H mm	L mm	P mm	€	1	013640003
	1300	1100	680	389,00		

1364SP

supporto con ventose per carrozzeria

particolarmente indicato per utilizzo con cristalli dotato di 4 ventose Ø 95 mm estensione regolabile mediante catena tubolare rivestita in polietilene



1364SP	H mm	L mm	€	1	013640004
	1250	950	194,00		

1364SR

distributore carrellato per rotoli carta da mascheratura

Caratteristiche tecniche:

- dotato di 2 ruote per la movimentazione
- 3 aste porta-rotolo con lama integrata per il taglio della carta
- supporto nastro di carta integrato
- Dimensione Max rotoli: 350 - 650 - 1050 mm



1364SR	L mm	P mm	H mm	H1 mm	€	1	013640005
	1530	520	1080	960	248,50		

1365/K13

pompa oleodinamica 10 t e kit accessori per carrozzeria in trolley

Inclusi nel kit:

- pompa oleodinamica 10 tonnellate con tubo flessibile da 1,5 m attacco 1/2"
- pistone corsa 205 mm
- pinza divarica-parafanghi capacità 500 kg
- piastra di appoggio 150x90 mm
- base a "L" 50x50 mm
- punzone a 4 punti
- punzone zigrinato tondo Ø 50 mm
- punzone a cuneo 43 mm
- prolunga 240 mm
- prolunga 450 mm
- prolunga 475 mm
- testa in gomma
- raccordo maschio maschio per montaggio accessori



1365/K13	€	1	013650013
	841,00		

900x420x180 mm

1365P10

pompa oleodinamica

Tubo da 1,5 m attacco 1/2"
Max 690 bar



1365P10	€	1	013650110
	375,00		

1366A

attrezzo levabolli con kit di 19 funghetti di plastica da utilizzare con colla a caldo per superfici verniciate 1851VK-12V

ideale per:

- bolli da grandine
- ammaccature causate da portiera
- piccole ammaccature in genere



1366A	€	1	013660200
	94,50		

1366B

massa battente per funghetti tirabolli in plastica

peso massa battente 500 g



L
mm 440 € 53,00 1 013660250

1366KF

kit 19 funghetti di plastica per articolo 1366A



1366/KF € 34,50 1 013660205

1366/K5

tirabolli pneumatico a massa battente da 1,1 kg

Inclusi nel kit:
• 1 ventosa Ø 75 mm
• 1 ventosa Ø 100 mm
• 1 ventosa Ø 125 mm
• 1 gancio



1366/K5 € 248,00 1 013660010

610x240x90 mm

1366SH

spotter multifunzione per la riparazione della carrozzeria

- Microprocessore per la gestione dei parametri di saldatura
- Partenza del ciclo di saldatura per contatto e manuale
- Possibilità di impostazione del tempo di puntatura automatico
- Fornito di pistola con attacco rapido e cavo massa da 2,2 m

Kit accessori composto da:

- Martello estrattore
- Testina per rondelle a tre punte
- 10 rondelle a 3 punte
- Elettrodo in carbone
- Elettrodo per schiacciatura



- Dati tecnici:
- Alimentazione: 230V
 - Potenza 50%: 2,5 KVA
 - Picco di potenza: 13 KVA
 - Amp. Out.: 2850 (2%) A
 - Amp Out MAX: 3200 A

1366SH € 2.120,00 1 013660400

1366SH/C

carrello per spotter 1366SH

Caratteristiche:

- Ripiano con predisposizione per il fissaggio dello spotter
- 2 ripiani accessori
- 2 ruote anteriori pivotanti dotate di freno
- 2 ruote posteriori fisse
- Supporti laterali per cavi ed accessori



1366SH/C € 414,00 1 013660410

1366SL

leva a tirare per ripristino lamiere

testina multigancio snodata per utilizzo con filo ondulato



L
mm 700 € 250,00 1 013660002

1366ST

traversa di tiro per ripristino lamiere

testina multigancio snodata per utilizzo con filo ondulato



L
mm 850 € 631,00 1 013660003

1366S/R1

mandrino per rondelle a 3 punte



1366S/R1 € 24,80 1 013660501

1366S/R2

rondella a 3 punti per tiraggio lamiere



1366S/R2 € 24,80 1 013660502

I prezzi indicati sono relativi a 20 pezzi

1366S/R3

elettrodo per rondelle Ø 8x16x1,5 mm



1366S/R3 € 30,00 1 013660503

Beta

1366S/R4

gancio per rondelle Ø 8x16x1,5 mm



1366S/R4 € 26,00 1 013660504

1366S/R5

rondelle Ø 8x16x1,5 mm



1366S/R5 € 14,30 1 013660505

I prezzi indicati sono relativi a 100 pz

1366S/R6

elettrodo per viti M5-M6



1366S/R6 € 28,50 1 013660506

1366S/R7

100 perni autofilettanti 5x18 mm



1366S/R7 € 24,80 1 013660507

1366S/R8

100 perni autofilettanti 5x25 mm



1366S/R8 € 34,00 1 013660508

1366S/R9

100 perni filettati M 5x18 mm



1366S/R9 € 22,90 1 013660509

1366S/R10

10 rondelle asolate



1366S/R10 € 15,80 1 013660510

1366S/R11

elettrodo per rondelle asolate



1366S/R11 € 80,50 1 013660511

1366S/R12

10 rondelle asolate a 90°



1366S/R12 € 31,50 1 013660512

1366S/R13

elettrodo carbone calda-lamiere



1366S/R13 € 58,00 1 013660513

I prezzi indicati sono relativi a 5 pezzi

1366S/R14

elettrodo per puntatuta filo



1366S/R14 € 28,00 1 013660514

1366S/R21

fili ondulati per utilizzo leva e traversa di tiro



1366S/R21 € 19,60 1 013660551

I prezzi indicati sono relativi a 10 pz

1366S/R22

supporto magnetico per filo ondulato



1366S/R22 € 67,50 1 013660552

1366S/R24

anello di tiro M4



1366S/R24 € 78,00 1 013660554

I prezzi indicati sono relativi a 5 pezzi

1366S/R25

anello di tiro M5



1366S/R25 € 78,00 1 013660555

I prezzi indicati sono relativi a 5 pezzi

1366S/R26

anello di tiro M6



1366S/R26 € 78,00 1 013660556

I prezzi indicati sono relativi a 5 pezzi

1367/S4

serie di fustelle per installazione sensori di parcheggio
misure:
23 - 24 - 27 - 28 mm

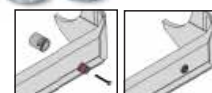

1367/S4 € 228,00 1 013670104



1367/K4

kit 4 morsetti ad arco per passaruota

Particolarmente idonei per mettere in asse il passaruota con la portiera



Apertura massima ganaschia: 6,5 mm

	L	H	S	€		
	mm	mm	mm			
1367/K4	62	40=58	15,7	70,00	1	013670010

1367/K10

kit di fustelle per installazione sensori di parcheggio

Incluse nel kit:

• misure: 17 - 18 - 18,2 - 19 - 20 - 22,5 - 24 - 26 - 26,7 - 32 mm



∅ 12 mm

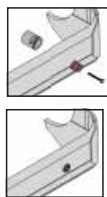

	€		
1367/K10	192,00	1	013670200

190x130x58 mm

Beta

1368

kit ripara plastiche

• permette di riparare velocemente crepe e rotture di parti in plastica

Alimentazione: 220+240 V con presa Shuko
 Lunghezza cavo pistola termica: 3,5 m
 Lunghezza cavo alimentazione: 1,35 m
 2 regolazioni di potenza: 35-75 W
 Pistola termica con terminali in ottone a 2 angolazioni di inserimento graffetta: 0°-90°
 Protezione input: disgiuntore termico
 Protezione output: fusibile 10 A
 Tasca metallica per riporre la pistola
 Fornito senza graffette

CE



	€		
1368	449,00	1	013680001

1368G/K400

assortimento di 400 graffette per 1368



	€		
1368G/K400	77,00	1	013680140

1368G/OD

graffette ondulate diritte per 1368



	€		
1368G/OD	19,20	1	013680100

I prezzi indicati sono relativi a 100 pezzi

1368G/SD

graffette a spirale diritte per 1368



	€		
1368G/SD	19,20	1	013680110

I prezzi indicati sono relativi a 100 pezzi

1368G/CV

graffette per angoli convessi per 1368



	€		
1368G/CV	19,20	1	013680120

I prezzi indicati sono relativi a 100 pezzi

1368G/C2U

graffette per angoli concavi per 1368



	€		
1368G/C2U	19,20	1	013680130

I prezzi indicati sono relativi a 100 pezzi

MANICI DEI MARTELLI

Manici in legno **hickory**

L'hickory è un legno con ottime qualità, perfette per il manico di un martello. La sua struttura a fibre lunghe assorbe le vibrazioni e lo rende molto resistente alla rottura. Nel remoto caso di rottura di alcune fibre il rischio di distacco improvviso della testa è comunque molto ridotto.

I manici in legno possono essere sostituiti quando usurati. Dato che il legno è un materiale naturale, è necessario che conservi la propria umidità. Si raccomanda pertanto di non conservare il martello in un luogo troppo secco.

Manici in **fibra di vetro**

I manici con anima in fibra di vetro sono resistenti e sicuri; riducono ai minimi termini i rischi di rotture e infortuni.

Resistono agli agenti atmosferici e agli agenti chimici più diffusi.



• **Anima indistruttibile in fibre di vetro**

• **Struttura ergonomica in polipropilene**

• **Rivestimento antiscivolo in confortevole elastomero**

1369/C11

assortimento di 11 utensili



1369/C11 € 896,00 1 013690033



470x340x70 mm - 15,2 kg

1370

martelli tipo tedesco
per meccanici
manico in legno



UNI 7778 DIN 1041

HICKORY

g	A mm	L mm	L1 mm	€		
100	15	260	82	12,70	5	013700051
200	19	280	95	14,30	5	013700052
300	23	300	105	16,30	5	013700053
400	25	310	112	18,50	5	013700054
500	27	320	118	19,90	5	013700055
600	30	330	122	23,10	5	013700056
800	33	350	130	26,00	4	013700058
1000	36	360	135	31,00	4	013700060
1500	42	380	145	35,50	2	013700065
2000	47	400	155	42,00	1	013700070

1370/MR...

manici di ricambio per 1370



	€		
1370MR 100 1370/100	5,70	4	013700081
1370MR 200 1370/200	6,35	4	013700082
1370MR 300 1370/300	6,90	4	013700083
1370MR 400 1370/400	7,40	4	013700084
1370MR 500 1370/500	8,10	4	013700085
1370MR 600 1370/600	8,95	4	013700086
1370MR 800 1370/800	9,35	4	013700088
1370MR 1000 1370/1000	10,00	4	013700090
1370MR 1500 1370/1500	11,30	4	013700095
1370MR 2000 1370/2000	12,70	4	013700100

1370T

martelli tipo tedesco
per meccanici
manico in fibra



g	A mm	L mm	L1 mm	€		
200	19	280	95	22,00	5	013700620
300	23	300	105	24,10	5	013700630
500	27	320	118	26,50	5	013700650
800	33	350	130	28,00	4	013700680
1000	36	360	135	35,50	4	013700700
1500	42	365	145	41,50	2	013700750

1370F

martelli tipo francese
per meccanici
manico in legno



NF E 71.014

A mm	L mm	L1 mm	€		
24	260	77	280	22,10	2 013700424
26	260	80	310	23,40	2 013700426
28	280	86	400	24,80	2 013700428
30	280	92	450	26,00	2 013700430
32	300	100	550	27,50	2 013700432
36	300	104	720	35,50	2 013700436
40	330	110	1065	39,00	2 013700440
42	330	116	1080	41,50	2 013700442
50	380	138	1760	43,50	2 013700450
60	380	160	2585	54,00	2 013700460

1370F/MR...

manici di ricambio per 1370F



	€		
1370F/MR 24 1370F/24-26	5,60	2	013700474
1370F/MR 28 1370F/28-30	6,10	2	013700478
1370F/MR 32 1370F/32-36	7,05	2	013700482
1370F/MR 40 1370F/40-42	8,85	2	013700490
1370F/MR 50 1370F/50	10,00	2	013700495
1370F/MR 60 1370F/60	12,10	2	013700496

1370FT

martelli tipo francese per meccanici,
manico in fibra



A mm	L mm	L1 mm	€		
28	280	86	530	36,00	1 013700528
30	280	92	625	37,50	1 013700530
32	300	100	750	39,00	1 013700532
36	300	104	930	46,50	1 013700536
40	330	110	1150	49,00	1 013700540
42	330	116	1250	50,50	1 013700542
50	380	138	2100	57,00	1 013700550
60	380	160	2750	61,50	1 013700560

1374F

martelli tipo francese
per falegnami
manico in legno



NF E 71.012

A mm	L mm	L1 mm	€		
16	250	80	180	17,70	2 013740416
20	270	86	250	19,70	2 013740420
22	290	92	335	20,30	2 013740422
26	290	103	425	22,90	2 013740426
28	310	108	510	24,10	2 013740428
30	310	117	580	25,50	2 013740430

1374F/MR...

manici di ricambio per 1374F



	€		
1374F/MR 16 1374F/16	5,20	2	013740456
1374F/MR 20 1374F/20	5,30	2	013740460
1374F/MR 22 1374F/22-26	5,40	2	013740462
1374F/MR 28 1374F/28	6,10	2	013740468
1374F/MR 30 1374F/30	6,55	2	013740470

Beta

1375

martello con penna a granchio
manico in legno



g	L1 mm	Ø mm	L mm	€	Icon	Icon
300	95	25	300	20,30	2	013750000

1375/MR

manici di ricambio per 1375



g	L1 mm	€	Icon	Icon
1375/MR		9,25	2	013750003

1375A

martelli con penna a granchio
manico in materiale plastico e fibra di vetro



oz	g	L mm	L1 mm	€	Icon	Icon
16	450	330	130	29,50	3	013750016
20	570	330	130	31,00	3	013750020

1375B

martelli con penna a granchio
manico in acciaio



oz	g	L mm	L1 mm	€	Icon	Icon
16	450	330	130	27,00	3	013750026
20	570	330	130	27,50	3	013750030

1376X

martelli a testa quadra,
con sede portachiodo e calamita,
penna a granchio, per carpentieri
manico in legno



g	A mm	L1 mm	L mm	€	Icon	Icon
250	20	125	450	19,40	3	013760125
300	25	130	450	20,50	3	013760130
400	27	132	450	22,50	3	013760140

1376X/MR

manico di ricambio
per 1376X



g	€	Icon	Icon
1376X/MR	10,90	2	013760161

1376XT

martelli a testa quadra,
con sede portachiodo e calamita,
penna a granchio, per carpentieri
manico in materiale plastico



g	A mm	L1 mm	L mm	€	Icon	Icon
250	20	125	500	23,30	3	013760525
300	25	130	500	24,80	3	013760530
400	27	132	500	26,50	3	013760540

1376XT/MR

manico di ricambio
per 1376XT



g	€	Icon	Icon
1376MR/XT	12,60	2	013760585

1377

martelli con testa tonda
e penna sferica
per calderai e lattonieri
manico in legno



HICKORY

g	L mm	L1 mm	€	Icon	Icon
340	330	95	29,50	2	013770134
450	350	102	31,00	2	013770145
570	350	110	35,50	2	013770157
680	360	116	37,00	2	013770168
900	380	120	38,50	2	013770190

1377/MR...

manici di ricambio per 1377



g	€	Icon	Icon
1377MR 340 1377/340	6,45	2	013770234
1377MR 450 1377/450	7,40	2	013770245
1377MR 570 1377/570	8,20	2	013770257
1377MR 680 1377/680	8,30	2	013770268
1377MR 900 1377/900	10,40	2	013770290

1377T

martelli con testa tonda e penna sferica
per calderai e lattonieri
manico in fibra



g	L mm	L1 mm	€	Icon	Icon
340	330	95	27,50	2	013770534
450	350	102	33,00	2	013770545
570	350	110	36,00	2	013770557
680	360	116	38,50	2	013770568
900	380	120	44,00	2	013770590

1378

martelli con testa tonda
e penna simmetrica
per calderai e lattonieri
manico in legno



HICKORY

g	L mm	L1 mm	Ø mm	€	Icon	Icon
340	330	100	27	27,00	2	013780134
570	350	115	32	35,50	2	013780157

1378/MR...

manici di ricambio per 1378



g	€	Icon	Icon
1378MR 340 1378/340	6,10	2	013780234
1378MR 570 1378/570	8,50	2	013780257

1379F

martelli tipo francese
per elettricisti
manico in legno



HICKORY

NF E 71.011

A mm	L mm	L1 mm	€	Icon	Icon
16	250	126	17,60	2	013790416
18	250	135	19,20	2	013790418
20	260	142	20,30	2	013790420

1379F/MR...

manici di ricambio per 1379F



1379F/MR 16	€ 5,50	2	013790426
1379F/16-18			
1379F/MR 20	€ 6,10	2	013790430
1379F/20			

1380

mazzette
manico in legno



HICKORY

UNI 7777 DIN 6475

g	A mm	L mm	L1 mm	€		
800	38	260	90	22,50	2	013800208
1000	40	260	95	24,30	2	013800210
1250	43	260	100	25,50	2	013800212
1500	45	280	110	29,50	2	013800215
2000	50	300	120	38,00	2	013800220

1380/MR...

manici di ricambio per 1380



1380MR 800	€ 7,15	2	013800238
1380/800-1000-1250			
1380MR 1500	€ 7,65	2	013800245
1380/1500			
1380MR 2000	€ 8,75	2	013800250
1380/2000			

1380S

mazzette con collare salvamanico
manico in legno
collare in materiale plastico



g	A mm	L mm	L1 mm	€		
800	36	260	90	24,80	2	013800400
1000	39	260	95	27,50	2	013800405
1250	43	260	100	29,50	2	013800410
1500	45	260	110	33,00	2	013800415

1380S/MR...

manici di ricambio per 1380S



1380S/MR 800	€ 7,40	2	013800417
1380S/800-1000-1250			
1380S/MR 1500	€ 8,10	2	013800419
1380S/1500			

1380T

mazzette
manico in fibra



g	A mm	L mm	L1 mm	€		
800	35	260	85	34,50	2	013800308
1000	40	260	100	35,00	2	013800310
1250	42	260	110	37,00	2	013800312
1500	45	260	120	39,50	2	013800315
2000	49	295	120	48,00	1	013800320

1381

mazze a coppia
manico in legno hickory



g	A mm	L mm	L1 mm	€		
3000	55	800	142	92,00	1	013810030
4000	60	900	152	102,50	1	013810040
5000	70	900	162	116,50	1	013810050
8000	80	900	185	201,50	1	013810080

1381/MR...

manici di ricambio per 1381



1381MR 3-4	€ 45,50	2	013810730
1381/3000-4000			
1381MR 5	€ 47,50	2	013810750
1381/5000			
1381MR 8	€ 47,50	2	013810780
1381/8000			

1381T

mazze a coppia
manico in fibra



g	A mm	L mm	L1 mm	€		
3000	55	900	142	100,00	1	013810330
4000	60	900	152	109,50	1	013810340
5000	70	900	162	125,00	1	013810350
8000	82	920	180	230,50	1	013810380

1385

mazzuole
con testa in rame
manico in legno



g	A mm	L mm	L1 mm	€		
400	26	260	75	35,00	2	013850404
600	32	270	80	50,50	2	013850406
800	34	280	90	66,50	2	013850408
1000	37	280	100	82,50	2	013850410
1500	43	280	110	121,50	2	013850415
2000	48	300	120	163,50	1	013850420

1385/MR

manici di ricambio per 1385



1385MR 400	€ 10,00	2	013850464
1385/400			
1385MR 600	€ 10,30	2	013850466
1385/600			
1385MR 800	€ 10,60	2	013850468
1385/800			
1385MR 1000	€ 11,40	2	013850470
1385/1000			
1385MR 1500	€ 12,70	1	013850475
1385/1500			
1385MR 2000	€ 13,00	1	013850480
1385/2000			

1390

mazzuole con battenti intercambiabili
in poliuretano
manico in legno
Durezza battenti: 45 Shore



UNI 7784

Ø mm	L mm	L1 mm	€		
22	260	70	19,90	5	013900022
28	280	85	24,70	5	013900028
35	310	95	33,50	5	013900035
45	320	107	53,50	4	013900045
60	380	128	90,50	2	013900060

1390/MR...

manici di ricambio per 1390



1390MR 22	€ 4,85	2	013900222
1390/22			
1390MR 28	€ 5,60	2	013900228
1390/28			
1390MR 35	€ 6,65	2	013900235
1390/35			
1390MR 45	€ 8,10	2	013900245
1390/45			
1390MR 60	€ 10,00	2	013900260
1390/60			

1390R

battenti di ricambio in poliuretano per 1390



Ø mm	€	Imp	Info
22	3,15	4	013900122
28	4,80	4	013900128
35	6,45	4	013900135
45	10,90	4	013900145
60	18,90	4	013900160

1390N

mazzuole con battenti intercambiabili in nylon, manico in legno

Battenti medio-duri: 75 Shore

Resistente all'olio e all'usura

Particolarmente indicato per lavorazioni su lamiera e metalli



UNI 7784

Ø mm	L mm	L1 mm	€	Imp	Info
22	260	70	19,90	3	013900522
28	280	85	24,70	3	013900528
35	310	95	33,50	3	013900535
45	320	107	53,50	2	013900545
60	380	128	90,50	2	013900560

1390NR

battenti di ricambio in nylon per 1390N



Ø mm	€	Imp	Info
22	3,15	4	013900622
28	4,80	4	013900628
35	6,45	4	013900635
45	10,90	4	013900645
60	18,90	4	013900660

1391

mazzuole antirimbalo interamente rivestite in gomma



Ø mm	L mm	L1 mm	€	Imp	Info
35	280	90	30,50	2	013910135
50	320	105	39,50	2	013910150
55	355	110	47,00	2	013910155
65	380	130	64,50	2	013910165

1391A

mazzuole per piastrellisti interamente rivestite in gomma



g	Ø mm	L mm	L1 mm	€	Imp	Info
500	45	290	100	28,50	2	013910205
1000	60	300	120	38,00	2	013910210

1392

mazzuole antirimbalo con battenti intercambiabili in materiale plastico manico in acciaio



Ø mm	L mm	L1 mm	€	Imp	Info
30	300	105	51,50	2	013920030
35	305	115	55,00	2	013920035
40	310	125	63,50	2	013920040
50	325	135	74,50	2	013920050
60	385	155	115,00	2	013920060

1392R

battenti di ricambio per 1392



Ø mm	€	Imp	Info
30	6,90	4	013920230
35	10,10	4	013920235
40	15,30	4	013920240
50	20,40	4	013920250
60	30,50	4	013920260

1393

mazzuole con testa in gomma dura



Ø mm	L mm	L1 mm	€	Imp	Info
50	315	90	13,50	3	013930050
60	340	110	15,30	3	013930060
70	370	130	18,40	2	013930070

AUTORIPARAZIONE

I nostri utensili per autoriparazione, usati dai professionisti più esigenti, sono sviluppati e prodotti per soddisfare gli standard più elevati al mondo e testati continuamente nelle condizioni di utilizzo più stressanti.

Da oltre 50 anni, siamo orgogliosamente a fianco dei più grandi campioni, che ci aiutano a migliorare costantemente i nostri prodotti e ne confermano il livello di qualità più assoluta.

Gli utensili dedicati all' autoriparazione si trovano in queste sezioni:

Diagnostica	da 1438 a 1499 da 1758VT a 1760TMC
Motore	da 955 a 989A da 1438 a 1499
Olio e filtri	da 1438 a 1499 da 1877 a 1885
Impianto elettrico	da 1438 a 1499
Avviatori	da 1498BC/12 a 1498/40A
Trasmissione	da 1438 a 1499
Sospensioni	da 1549 a 1569CP
Freni	da 1438 a 1499
Ruote	da 955 a 989A
Carrozzeria	da 1302 a 1369 da 1763 a 1767A
Altre attrezzature	da 1875LT a 3067
Sollevatori	da 3029/2T a 3067/70-13T



1410/M

attrezzo ad uncino
per trazionamento molle



Ø mm	€	Immagini	Articolo
3,5	19,50	2	014100051

1428

estrattori per dadi destrorsi danneggiati
con attacco quadro



Ø mm	□ mm	L mm	Ø mm	€	Immagini	Articolo
8	3/8	36	17	19,40	2	014280008
10	3/8	36	17	19,40	2	014280010
11	3/8	36	17	19,40	2	014280011
12	3/8	36	19	19,40	2	014280012
13	3/8	36	19	19,40	2	014280013
14	3/8	36	19	19,40	2	014280014
15	1/2	38	21	20,50	2	014280015
16	1/2	38	21	20,50	2	014280016
17	1/2	38	21	20,50	2	014280017
18	1/2	38	26	20,50	2	014280018
19	1/2	38	26	20,50	2	014280019
20	1/2	38	26	22,80	2	014280020
21	1/2	38	26	22,80	2	014280021
22	1/2	38	26	24,80	2	014280022
24	1/2	38	26	24,80	2	014280024
27	1/2	38	26	26,00	2	014280027

1428L

estrattori a bussola lunghi
per dadi destrorsi danneggiati
con attacco quadro



Ø mm	€	Immagini	Articolo
17	49,00	1	014280217
19	50,50	1	014280219
21	54,50	1	014280221



Articolo	€	Immagini	Articolo
1428L/B3 17-19-21 mm	154,00	1	014280303



Articolo	€	Immagini	Articolo
1428/SB11 8-10-11-12-13-14 15-16-17-18-19 mm	236,00	1	014280111
1428/SB5 20-21-22-24-27 mm	131,00	1	014280115

1429

estrattori per viti e prigionieri danneggiati
con attacco quadro



mm	□ mm	L mm	€	Immagini	Articolo
2	3/8	60	12,80	3	014290002
3	3/8	60	12,80	3	014290003
4	3/8	60	12,80	3	014290004
5	3/8	60	13,50	2	014290005
6	3/8	60	13,50	2	014290006
8	1/2	70	14,70	2	014290008
10	1/2	70	15,00	2	014290010



Articolo	€	Immagini	Articolo
1429/SB7 2-3-4-5-6-8-10 mm	107,00	1	014290107

1430/...

estrattori conici per viti
e prigionieri spezzati
in acciaio legato

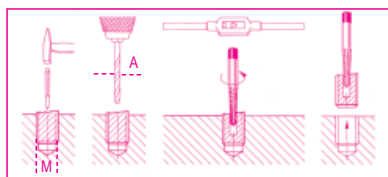

Articolo	M mm	A mm	€	Immagini	Articolo
1430/1	3+6	2,5	3,60	10	014300006
1430/2	6+8	3,0	4,00	10	014300008
1430/3	8+11	4,5	4,80	10	014300011
1430/4	11+14	6,0	6,35	10	014300014
1430/5	14+18	8,0	7,15	10	014300018
1430/6	18+24	11,0	14,00	5	014300024
1430/7	24+33	14,0	21,00	5	014300033
1430/8	33+50	21,0	27,00	5	014300050



Articolo	€	Immagini	Articolo
1430/S5 1430/1-1430/2-1430/3 1430/4-1430/5	27,00	1	014300105
1430/S6 1430/1-1430/2-1430/3 1430/4-1430/5-1430/6	38,50	1	014300106
1430/S8 1430/1-1430/2-1430/3 1430/4-1430/5-1430/6 1430/7-1430/8	86,50	1	014300108

1431/...

estrattori conici per viti e prigionieri spezzati

per la rimozione di viti e prigionieri che non offrono possibilità di presa
inserimento a percussione

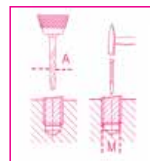

Articolo	M mm	A mm	L mm	□ mm	€	Immagini	Articolo
1431/3	3+6	2,5	59	5	6,45	10	014310051
1431/5	6+8	5,0	68	5	6,45	10	014310052
1431/6	8+11	6,0	72	6	7,65	10	014310053
1431/8	11+14	8,0	77	8	8,30	10	014310054
1431/9	14+18	9,0	82	9	8,95	10	014310055

1431/C5

estrattori conici per viti e prigionieri spezzati

Inserimento a percussione

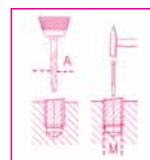

Articolo	M mm	A mm	€	Immagini	Articolo
1431/C5 3+18	2,5+9	38,00	1	014310005	

1433

estrattori a rulli
per viti prigioniere

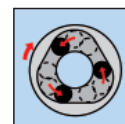
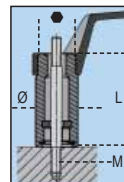

M mm	Ø mm	L mm	● mm	□ mm	€	Immagini	Articolo
5	21	60	19	3/8	14,30	2	014330005
6	24	60	21	1/2	14,30	2	014330006
7	24	60	21	1/2	14,30	2	014330007
8	24	60	21	1/2	14,30	2	014330008
9	28	70	21	1/2	17,00	2	014330009
10	28	70	21	1/2	17,00	2	014330010
10,5	28	70	21	1/2	17,00	2	014330021
11	28	70	21	1/2	17,00	2	014330011
12	28	70	21	1/2	17,00	2	014330012
14	36	72	24	-	27,00	2	014330014
16	36	72	24	-	27,00	2	014330016

1433/C11

estrattori a rulli
per viti prigioniere

36"
12"
●



1433/C11 € 277,00 1 014330311
M5 - M6 - M7 - M8 - M9 - M10 - M10,5
M11 - M12 - M14 - M16
340x135x56 mm - 3,0 kg

1435

estrattore ad eccentrico
per viti prigioniere



∅ mm 4÷20 € 104,00 1 014350001

1435R

rotella di ricambio per 1435



1435R € 32,50 1 014350010

1435/1

estrattore ad eccentrico
per viti prigioniere



∅ mm 19÷26 € 129,00 1 014350002

1435/1R

rotella di ricambio per 1435/1



1435/1R € 33,50 1 014350011

1437/C12

assortimento 12 utensili per rimozione air bag



1437/C12 € 103,50 1 014370001
260x160x55 mm - 1,0 kg

1438

attrezzo universale
per centraggio frizioni
completo di 3 coni ad espansione



1438 € 56,00 1 014380001

1438R

coni ad espansione
di ricambio per 1438



∅ mm 14÷18 € 3,80 5 014380101
18÷21 € 3,80 5 014380102
22÷25 € 3,80 5 014380103

1438EVO

kit universale per centraggio frizioni

Componentistica interamente in metallo



1438EVO € 249,00 1 014380011
290x200x60 mm - 2 kg

1438DSG

leva per bloccaggio/sbloccaggio cambio DSG
a doppia frizione del gruppo VAG



1438DSG € 34,00 1 014380200

1438K/DSG-2

kit per ripristino frizione DSG
a 6 e 7 rapporti

utilizzabile per cambi 6 marce DSG e manuale,
DSG 7 marce prima, seconda serie e S-tronic.



1438K/DSG-2 € 627,00 1 014380260
350x370x117 mm - 10 kg

1438K/PWR

kit per rimozione ed installazione
doppia frizione cambio Powershift



1438K/PWR € 429,00 1 014380270
440x400x85 mm - 10 kg

1438DCT/S

kit di ripristino doppie frizioni Ford a secco

necessario per il riallineamento della frizione dopo aver effettuato interventi tipo sostituzione paraoli del cambio



1438DCT/S € 326,00 1 014380305

440x400x85 mm - 8 kg

1439/K7

cassetta giravite angolare 90° tipo lungo con lame



Dotazione valigetta:
- Giravite angolare
- 1 Testa per viti ad intaglio
- 1 Testa per bits 1/4
- 1 Testa per lame speciali
- 7 lame speciali

1439K7 € 208,00 1 014390101

500x120x60 mm 825 g

1440/...

attrezzi per inserimento pistoni



	∅ mm	L mm	€		
1440/0	40÷75	50	31,00	1	014400000
1440/1	57÷125	80	40,50	1	014400010
1440/1A	57÷125	100	46,00	1	014400011
1440/2	90÷175	80	49,00	1	014400020
1440/2A	90÷175	100	51,50	1	014400021
1440/3	90÷175	165	75,00	1	014400030

1445/1 - 1445/2

attrezzi per segmenti di pistoni



	∅ mm	€		
1445/1	50÷100	42,50	1	014450001
1445/2	90÷150	54,50	1	014450002

1452K

morsetto alzavalvole con tre flange

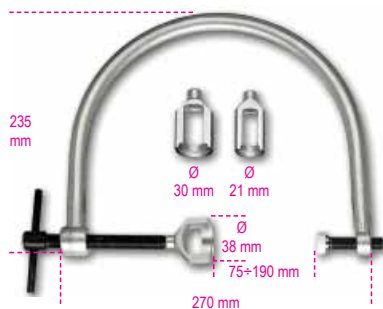

1452K € 161,50 1 014520100

1452PN/K

attrezzo pneumatico per molle valvole motore

pressione di spinta 1400 N

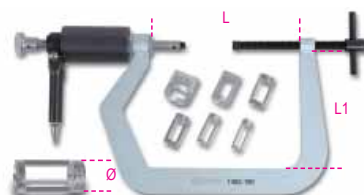

∅ mm	L mm	L1 mm	€		
16-19-23	230	185	344,00	1	014520110
25-30-42					

1454P

raschietto per rimozione residui di guarnizioni e sigillanti

particolarmente indicato per pulire testate e superfici piane da accoppiare



L mm	L1 mm	∅ mm	€		
210	32	3,3	45,00	1	014540010

1455SVP

smerrigliavalvole pneumatico

• Pressione di utilizzo 6 Bar



1455SVP € 393,00 1 014550001

1455SVP/R...

ventose in gomma di ricambio per 1455SVP



	€		
1455SVP/R1	7,05	5	014550501
1455SVP/R2	7,05	5	014550502
1455SVP/R3	7,05	5	014550503

1457/B4

serie di attrezzi per lo sbloccaggio dei connettori Rilsan

Misure incluse:

- 6x8
- 10x12
- 15x16
- 18x12



1457/B4 € 52,50 1 014570024

1458

pinza per anelli elastici di sicurezza SP per alberi



DIN 5417	∅ mm	€		
	30÷100	77,00	2	014580001

1460F

pinza per anelli di tenuta valvole



270 mm

1460F € 66,00 1 014600010

1462CF/C6

serie di 6 chiavi poligonali aperte per raccordi carburante iniettori

misure:
12-14-16-17-18-19 mm

12"



1462CF/C6 € 102,50 1 014620006

260x145x60 mm - 1,2 kg

1462CF

chiavi poligonali aperte per raccordi carburante iniettori

12"



mm	€		
12	16,30	1	014620012
14	16,50	1	014620014
16	16,80	1	014620016
17	17,20	1	014620017
19	18,10	1	014620019
18	17,60	1	014620018

1462CF-SN/C6

serie di 6 chiavi snodate esagonali aperte per raccordi carburante iniettori

misure:
12-14-16-17-18-19

38"



1462CF-SN/C6 € 148,50 1 014620026

275x182x64 mm

1462CF-SN

chiavi snodate esagonali aperte per raccordi carburante iniettori

38"



mm	€		
12	26,00	1	014620032
14	26,50	1	014620034
16	28,00	1	014620036
17	28,50	1	014620037
18	29,00	1	014620038
19	30,50	1	014620039

1462/KI

assortimento utensili per estrazione iniettori Diesel Common Rail

Permette la rimozione degli iniettori DELPHI-BOSCH-SIEMENS-DENSO



1462/KI € 2.660,00 1 014620235

530x470x140 mm - 2,0 kg

1462/KU

assortimento utensili universale per estrazione iniettori diesel common rail completo di pinza e massa battente



1462/KU € 795,00 1 014620100

390x290x100 mm - 4,5 kg

1462/MB

kit a massa battente per estrazione iniettori incluso nel kit:

- 1 massa battente da 4 kg con asta da 400 mm
- 1 adattatore snodato maschio M10x1,5 femmina M22x1,5 mm
- 1 adattatore maschio M22x1,5 femmina M13x1,4 mm
- 1 adattatore maschio M14x1,5 femmina M27x1 mm
- 1 adattatore maschio M14x1,5 maschio M25x1 mm
- 1 adattatore maschio M14x1,5 maschio M27x1 mm
- 1 adattatore maschio M14x1,5 femmina M14x1,5 mm
- 1 adattatore maschio M14x1,5 maschio M20x1 mm
- 1 adattatore maschio M14x1,5 maschio M17x1 mm



1462/MB € 320,00 1 014620110

500x250x80 mm - 7,2 kg

1462AD/BSC

adattatore per estrazione iniettori Bosch Common Rail

da utilizzare con articoli Beta 960KI, 1462KI e Beta 1462/KU



1462AD/BSC € 230,50 1 014620435

1462AD/SMN

kit di adattatori per estrazione iniettori Siemens e Denso

da utilizzare con articolo Beta 960KI/1462KI



1462AD/SMN € 345,00 1 014620436

1462/EI

attrezzo universale a vibrazioni per estrazione iniettori

- Favorisce la rimozione di iniettori fortemente grippati dall'alloggiamento, senza arrecare danni alla testata ed evitando possibili rotture
- Utilizzabile con qualsiasi set di estrazione iniettori con o senza massa battente
- L'attrezzo agisce direttamente con vibrazioni e impulsi sul tirante di estrazione, che è accoppiato con l'iniettore
- Attraverso la valvola di regolazione è possibile adeguare l'intensità della vibrazione in base al tipo di intervento da eseguire.

CE



1462/EI € 703,00 1 014620240

Beta
Quality Tools

1463/KIT

kit attrezzatura per blocco pulegge distribuzione



1463/KIT € 429,00 1 014630001
280x140x75 mm - 1,2 kg

1464T

tester digitale per la misurazione di pressione e compressione

CARATTERISTICHE

- display touch screen da 5"
- batteria ai polimeri di litio ricaricabile
- completo di sensore da 80 bar (basse pressioni) e cavo USB



Caratteristiche:

- Display touch screen da 5"
- Batteria ai polimeri di litio ricaricabile
- Completo di sensore da 80 bar (basse pressioni) e cavo USB
- Dotato di memoria interna per memorizzare i dati rilevati affinché possano essere successivamente trasmessi a un computer

Un importante vantaggio dell'art. 1464T è che si possono acquistare diversi kit supplementari, con cui è possibile effettuare altri test.

- 1464ADB set per la verifica della pressione dell'impianto AdBlue®
- 1464FAP set per la verifica della pressione del filtro antiparticolato DPF
- 1464VD set per la verifica della depressione/vuoto
- 1464APB set per la verifica dell'impianto alta pressione benzina nei motori FSI
- 1464PF set per la verifica dell'impianto frenante
- 1464PT set per verifica della pressione del turbo
- 1464TDI set per la verifica della pressione della pompa nei motori TDI
- 1464FG set di falsi regolatori per la verifica del sistema diesel common rail
- 1464PB set di 9 connessioni per la verifica della bassa pressione carburante
- 1464CBD set completo di adattatori per la verifica della compressione nei motori benzina e diesel
- 1464IC set di finti iniettori e finte candele per la verifica della compressione nei motori diesel
- 960AD/TP2 set di adattatori per la verifica della compressione nei motori diesel e benzina, della pressione olio e carburante

1464T € 935,00 1 014640050

1464T/SP80

sensore di pressione da 80 bar per 1464T e 960TP



1464T/SP80 € 321,00 1 014640053

960AD/TP2

set di adattatori per 1464T e 960TP in valigetta di plastica



960AD/TP2 € 554,00 1 009600510
430x310x50 mm - 3,2 kg

1464CBD

set completo di adattatori per la verifica della compressione nei motori benzina e diesel con 1464T

Permette di collegarsi al motore per la verifica della compressione benzina e diesel attraverso lo strumento 1464T

Include:

- n° 7 false candele con valvola di non ritorno
- n° 44 false candele
- n° 1 falso iniettore regolabile universale per auto, truck, motori marini e macchine agricole
- n° 1 adattatore a 90°, valvola di scarico pressione e tubo di collegamento
- spazio per poter alloggiare lo strumento 1464T all'interno della valigetta



1464CBD € 763,00 1 014640300
510x410x140 mm - 5,5 kg

1464IC

set completo di finti iniettori e finte candele, per 1464T

Permette di collegarsi al motore per la verifica della compressione nei motori diesel con tester digitale 1464T.

Include:

- n° 22 false candele
- n° 5 falsi iniettori
- n° 1 kit falso iniettore universale per auto, truck, motori marini e macchine agricole



1464IC € 627,00 1 014640350
559x312x50 mm - 4,5 kg

1464IC/RK

kit falso iniettore universale per auto, truck, motori marini e macchine agricole

incluso in art. 1464IC



1464IC-RK € 202,50 1 014640377
200x110x30 mm - 885 g

1464AP

set per la verifica dell'impianto alta pressione dei motori diesel common rail, per 1464T

Fornito con:

- set tubi alta pressione
- raccordi di collegamento
- sensore da 2.000 bar



1464AP € 844,00 1 014640450
430x310x50 mm - 1,8 kg

1464AP T

tubo alta pressione per 1464AP e 960TAP



1464AP T12X12 € 66,00 1 014640453
1464AP T12X14 € 66,00 1 014640454
1464AP T14X12-M1,0 € 66,00 1 014640455

1464AP T16X12

tubo alta pressione 16x12 per sistema Bosch CP4, da utilizzare con 1464AP



1464AP T16X12 € 78,00 1 014640456

1464FG

set di falsi regolatori
per la verifica del sistema diesel common rail
(da utilizzare con Beta 1464T-1464AP)

Utilizzato con il tester e gli adattatori idonei, permette di stabilire se il problema risiede nella pompa alta pressione nel regolatore in caso di assenza di pressione nel circuito di alta pressione nei motori diesel common rail.
Indicato per regolatori di pressione Bosch, Delphi, Denso e Siemens



1464FG € 326,00 1 014640470
350x250x80 mm - 1,8 kg

1464FG/CP4

falso regolatore per pompa Bosch CP4
non incluso in 1464FG



1464FG/CP4 € 47,50 1 014640475

1464APB

set per la verifica dell'impianto
alta pressione benzina
dei motori FSI,
per 1464T
Include sensore da 200 bar
e raccordi di collegamento



1464APB € 415,00 1 014640500
240x210x50 mm - 0,5 kg

1464PB

set di 9 connessioni per la verifica
della bassa pressione carburante
(da utilizzare con 1464T)

Attraverso le connessioni rapide collegate al tester 1464T
si effettua rapidamente la verifica della bassa pressione
carburante
nei motori diesel e benzina



1464PB € 578,00 1 014640700
530x440x120 mm - 3,8 kg

1464ADB

set per la verifica della pressione
dell'impianto AdBlue®
per 1464T

Fornito con adattatori da utilizzare con il sensore standard da
80 bar presente nel 1464T



1464ADB € 96,00 1 014640620
240x210x50 mm - 0,5 kg

1464FAP

set per la verifica della pressione
del filtro antiparticolato DPF
per 1464T

Fornito con:
- sensore da 500 mbar
- adattatore da 8 mm con attacco rapido e raccordo a T
- cavo RJ45 da 3 metri



Dati tecnici:
• Test della pressione: 0÷500 mbar
• Risoluzione: 1 mbar

1464FAP € 206,00 1 014640610
240x210x50 mm - 0,5 kg

1464PT

set per la verifica
della pressione del turbo,
per 1464T

Include sensore da 3bar
e cavo di collegamento



1464PT € 181,50 1 014640550
240x210x50 mm - 380 g

1464TDI

set per la verifica
della pressione della pompa
nei motori TDI,
per 1464T

Include raccordo
di collegamento



1464TDI € 130,00 1 014640600
240x210x50 mm - 400 g

1464VD

set per verifica della depressione/vuoto per
1464T

Permette la misurazione e memorizzazione del valore
massimo della depressione

Fornito con:
- sensore da 800 mbar
- adattatori da 6 e 8 mm
- cavo RJ45 da 3 metri

Dati tecnici:
• Test del vuoto: 0÷800 mbar
• Risoluzione: 1 mbar
• Memorizzazione del valore massimo



1464VD € 206,00 1 014640570
240x210x50 mm

 Beta

1464PF

set per la verifica della pressione nell'impianto frenante, per 1464T
Include adattatori e raccordi



1464PF € 744,00 1 014640650
400x280x60 mm - 3 kg

1465

strumento di verifica dell'efficienza del motore

Permette di verificare in pochi secondi la compressione dei motori endotermici senza doversi collegare al motore, prelevando l'alimentazione dalla batteria del veicolo, attraverso un software dedicato



- 1° Fase: calcolo giri/motore
- 2° Fase: analisi andamento tensione batteria durante ogni singolo giro
- 3° Fase: visualizzazione potenza elettrica assorbita e compressione relativa calcolata attraverso il lavoro del motorino di avviamento per ogni pistone
- 4° Fase: verifica stato di carica ed efficienza della batteria

Dati tecnici:

- Tensione di funzionamento: 12V DC (batteria veicolo)
- Dimensioni: 140x75x30 mm
- Lunghezza cavo pinze: 1300 mm
- Peso: 365 g

1465 € 1.250,00 1 014650010

1466/C5

kit 5 chiavi per spurgo freni
inclusi nel kit:
• 5 chiavi misura 7-8-9-10-11 mm
• 1 tubo di scarico con valvola di non ritorno



1466/C5 € 137,00 1 014660100
260x170x50 mm - 600 g

1466L 11

chiave 11 mm per spurgo freni versione lunga



1466L 11 € 34,00 1 014660211
11 mm L 60 mm

1466TLF

tanica per recupero olio freni capacità 1,5 litri

Attacco rapido per tubo di spurgo Ø 5,5 mm



1466TLF € 49,00 1 014660201

1467

strumento estrazione liquido freni



Pressione min 5 bar, Max 11,5 bar

1467 € 365,00 1 014670001

1467/RK1

kit tubo di ricambio per 1467



1467/RK1 € 27,50 1 014670501

1467/RK2

rabboccatore di ricambio per 1467



1467/RK2 € 105,00 1 014670502

1467LF/2

strumento elettrico per sostituzione liquido freni
dotato di "effetto pulsante"



"Effetto pulsante"

- stop automatico con tanica vuota, che impedisce l'inserimento di aria
 - volume massimo tanica: 20L
 - pressione di esercizio: 0,4÷3,5 bar
 - alimentazione 230V
- Dotazione inclusa:
- tanica di recupero olio dai freni
 - 1 tappo E20 standard

1467LF/2 € 1.905,00 1 014670099

1467LF/RC

contenitore con tubo di recupero per 1467LF



1467LF RC € 115,50 1 014670125

1467TU

tappo per vaschette liquido freni

- adattabile al 90% delle vaschette del parco circolante
- utilizzabile con articolo Beta 1467LF



1467TU € 71,50 1 014670090

1467T/C6

kit di tappi adattatori per vaschette liquido freni utilizzabile con BETA 1476LF e 1467LF/2

inclusi nel kit:

- 1 tappo per Toyota
- 1 tappo Ford, Hyundai, Mazda, Mitsubishi, Nissan, Subaru
- 1 tappo Honda
- 1 tappo Mazda e Suzuki
- 1 tappo Nissan
- 1 tappo adattatore per spurgo freni veicoli europei



1467T/C6 € 290,00 1 014670080

350x240x85 mm - 1,8 kg

1470

pinze per molle freni a tamburo



L mm € 1 014700001
210 42,50
330 54,50
540 163,50 1 014700010

1470FT

pinza per fermi molle ceppi freni a tamburo

Becchi inclinati a 40°
Accesso facilitato nei punti scomodi

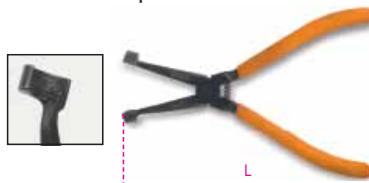

L mm € 1 014700000
184 45,00

1470PF

attrezzo per la sostituzione dei cilindri nei freni a tamburo

le ganasce restano divaricate, ed il cilindro viene facilmente sostituito

38"



17 mm

A mm € 1 014700200
25÷140 82,00

1471

pinza per molle freni a tamburo



L mm € 1 014710001
330 83,00

1471A

pinza per cavo freno a mano

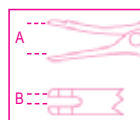

220 mm

A max mm B mm € 2 014710010
45 5 101,00

1471GF

coppia di ganci modellabili per il sostegno della pinza freno durante la sostituzione delle pastiglie



Max kg € 1 014710310
5 15,30



1471M/C22

utensile pneumatico per arretrare e ruotare i pistoncini dei freni a disco destrorsi e sinistrorsi con accessori

- martinetto automatico
- 150 Kg di spinta
- pressione di utilizzo 5÷8 bar



1471M/C22 € 326,00 1 014710101

350x310x85 mm - 3,5 kg

1471M/50

martinetto pneumatico per arretrare e ruotare i pistoncini dei freni a disco destrorsi e sinistrorsi

- martinetto automatico
- 150 Kg di spinta
- pressione di utilizzo 5÷8 bar

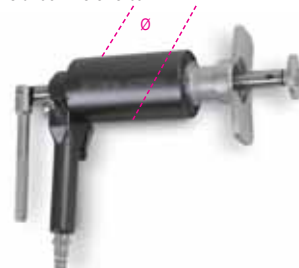

Ø mm Kg Bar € 1 014710069
50 150 5÷8 179,50

1471M/P

adattatore per pastiglie usurate e pinze TRW-Mégane



1471M/P € 28,00 1 014710080

1471M/W50

adattatore per freno stazionamento VW
Passat ≥ 2005

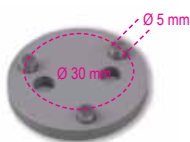

1471M/W50 € 9,80 1 014710079

1471PN/B1

adattatore per freno stazionamento Ford



1471PN/B1 € 9,80 1 014710081

1471PN/B2

adattatore per freno stazionamento Daily



1471PN/B2 € 13,60 1 014710082

1471PN/B3

adattatore per freno stazionamento BMW



1471PN/B3 € 9,80 1 014710083

1471PN/B4

adattatore per freno stazionamento BMW



1471PN/B4 € 9,80 1 014710084

1471PN/B5

adattatore per freno stazionamento Mini/ BMW



1471PN/B5 € 8,50 1 014710085

1471CF

chiavi a bussola a mano bocca pentagonale
per dadi pinze freno



mm
14 € 19,20 1 014710314
19 € 19,20 1 014710319

1471CM

chiave a bussola maschio pentagonale per viti
pinze freno



mm
10 € 19,20 1 014710360

1471CM/E11

chiave a bussola maschio esagonale 11 mm
per viti pinze freno Mercedes ML
(serie 166)



mm
11 € 20,30 1 014710361

1471PT/C5

kit bussole a Macchina per dadi pinze freno

Per vetture Volkswagen, Audi e Porsche
• 3 bussole a 10 denti: 11,5 mm - 15 mm - 20 mm
• 1 bussola a 7 denti



1471PT/C5 € 78,00 1 014710367



1471D2

arretratore pistoncini freni a disco anteriori
con pinze chiuse

doppia coppia di piastre per operare
su pinze a 2 e 4 pistoncini



mm
10 € 84,00 1 014710301
250x170x60 mm 1,5 kg

1471T/C5

5 chiavi a battere per pinze freno truck

in fase di serraggio sono utilizzabili con chiave
dinamometrica
misure incluse:
• Torx femmina E18, E20, E24
• poligonali M24, M26



1471T/C5 € 270,00 1 014710400

275x220x60 mm - 3,1 kg

1472

pinza per anelli stringitubo

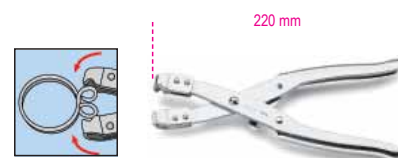

1472 € 47,50 1 014720001

1472AU

pinza automatica
per anelli stringitubo



mm
18÷53 € 139,00 1 014720100

1472R/AU

puntali di ricambio per pinza 1472AU



1472AU/R € 53,50 1 014720101

1472AU/P

pinza automatica con prolunga per anelli stringitubo

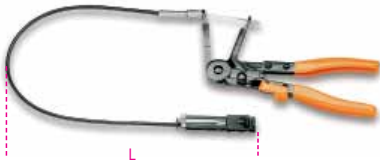

∅ mm 18+54 L mm 630 € 122,50 1 014720105

1472AU/RP

cavo di ricambio per pinza 1472AU/P



1472AUP/R € 30,00 1 014720106

1472B/RNLT

bussola con doppia impronta, dedicata per fascette manicotto aspirazione montate su motori gruppo Renault



1472B/RNLT € 19,40 1 014720250

1472FC

pinza con teste orientabili, per fascette Clic®



1472FC € 44,00 1 014720090

1472FC/GE

pinza a grande effetto, per fascette Clic®

particolarmente indicata per fascette di grandi dimensioni



L mm 230 € 77,00 1 014720093

1472FC/L

pinza con prolunga flessibile a testa orientabile a 360°, per fascette Clic®



L mm 630 € 117,50 1 014720095

1472FCL/RP

cavo di ricambio per pinza 1472FC/L



1472FCL/RP € 52,50 1 014720096

1472FCA

pinza per rimozione fascette con cremagliera tipo Visa®



1472FCA € 66,50 1 014720041

1472H

attrezzo per rimozione fascette Henn



1472H L mm 100 € 26,00 1 014720000

1472MT/VW

coppia di graffe per scollegamento collettori di aspirazione gruppo VAG
Utilizzabile su motori turbo benzina 1.0 - 1.2 - 1.4



1472MT/VW € 12,60 1 014720500

1472TM

pinza per scollegare i raccordi rapidi dei filtri multijet



1472TM € 31,00 1 014720200

1472VW

pinza con teste orientabili per fascette stringitubo per vetture del gruppo Volkswagen e Mercedes



1472 VW € 49,50 1 014720051

1473
pinza per collari OETIKER®



1473 275 € 137,00 1 014730001

1473A
pinza con reggiasola per collari OETIKER®



1473A € 104,00 1 014730010

1473P
pinza per collari OETIKER® pinzabili a basso profilo



1473P A Max mm 53 € 38,50 1 014730020

1473FN
attrezzo per serraggio e taglio fascette a nastro in acciaio inox

utilizzabile con fascette Panduit® e similari



A mm 4,7÷9,5 € 71,50 1 014730501

1473T
tronchese per rimozione fascette in acciaio
permette di tagliare le fascette senza rischiare il danneggiamento di cuffie, manicotti, ecc.



A Max mm 14 L mm 220 € 65,00 1 014730582

1474/C4
kit 4 utensili estrazione bobine candele Volkswagen



1474/C4 € 108,50 1 014740100

290x190x50 mm - 1 kg

1474E/VW
estrattore ad espansione per bobine accensione gruppo Volkswagen



1474E/VW € 30,00 1 014740120

1474E/VW2
estrattore bobine accensione gruppo VAG
utilizzabile su motori 1.0 - 1.2 - 1.4 - 2.0



1474E/VW2 € 36,50 1 014740150

1474L
pinza per cappucci candele d'accensione a becchi lunghi piegati 15°

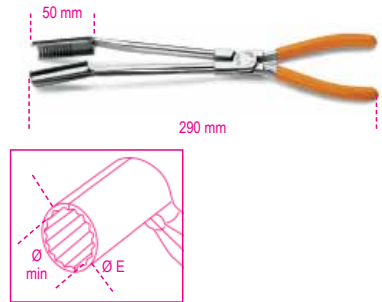

Ø min mm 14 Ø E mm 20 € 87,50 2 014740010

1474DL
pinza per cappucci candele d'accensione a becchi lunghi manici ricoperti con 2 strati in PVC



1474DL € 42,00 1 014740015

1474G
pinza a becchi lunghi piegati per cappucci candellette di preriscaldamento



1474G € 47,00 1 014740200

1475U
pinza universale cromata lucida con impugnatura a "pistola" manici ricoperti con 2 strati in PVC

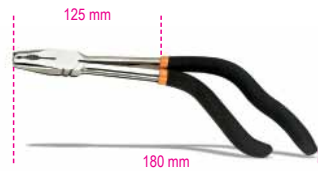

1475U € 44,00 1 014750010

1476

pinza regolabile autobloccante per taglio tubi di scarico

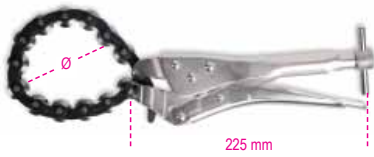

Ø min mm	Ø max mm	L mm	€	1	014760002
19	75	225	84,00		

1476/RC

catena di ricambio per 1476



1476RC	€	1	014760012
	41,50		

1476A

pinza per taglio tubi di scarico



Ø min mm	Ø max mm	€	1	014760005
30	95	107,00		

1476A/RC

catena di ricambio per 1476A



1476A/RC	€	1	014760015
	92,00		

1476C/1

attrezzi espansori per tubi di scarico



1476C/1	€	1	014760101
Ø 30=42 mm	40,50		
L = 131 mm			
L1 = 51 mm			

1476GT

pinza per rimozione supporti in gomma per tubi di scarico



L mm	A Max mm	mm	€	1	014760050
280	58	3	37,00		

1476PSA

pinza per fascette di scarico con perno, gruppo PSA la forma dei becchi e il blocco automatico della cremagliera permettono di operare senza sfilare il perno



L mm	A Max mm	S mm	€	1	014760060
309	60	12,2	45,50		

1476T

chiave per smontaggio/montaggio turbine su motori diesel, gruppo Volkswagen Audi



mm	€	1	014760200
12	41,50		

1477/C10

chiave curva con 9 inserti per dadi tendicinghia

1 chiave curva con attacco per inserti
4 inserti poligonali doppi: 12x14 - 13x15 - 16x17 - 18x19 mm
5 inserti per viti con profilo Torx: E10 - E12 - E14 - E16 - E18



1477/C10	€	1	014770310
530x110x55 mm	176,00		

1477D

chiavi poligonali per dadi tendicinghia



mm	€	1	014770113
13	31,50		
15	31,50		014770115
16	31,50		014770116
17	31,50		014770117
19	31,50		014770119

1477D/S5

serie di 5 chiavi poligonali per dadi tendicinghia



1477D/S5	€	1	014770200
13-15-16-17-19 mm	157,50		
600x200x70 mm - 2,2 kg			

1477K/7

kit chiave curva a cricchetto reversibile con inserti

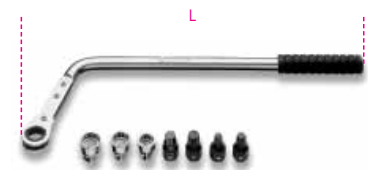

- 2 Inserti Torx® T40-T45
- 1 Inserto XZN® 10
- 1 Inserto esagonale 8 mm
- 3 Inserti poligonali 10-12-13 mm

1477K/7	€	1	014770051
L mm	250	154,00	

1478

pinza per estrazione pioli



1478	€	1	014780001
	61,00		

1478NSS

pinza per pioli in plastica
con 3 punti di sblocco



L
mm
180 € 44,00 1 014780163

1478T

pinza con testa orientabile per pioli
in plastica con clips a pressione

testa orientabile a 90°

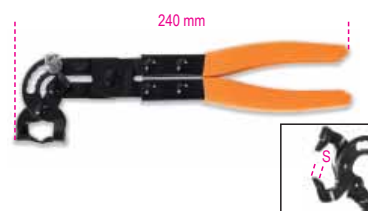

S
mm
4,5 € 47,50 1 014780101

1478/K3

kit pinze per pioli con assortimento clips in
plastica

il kit include:

- 1 pinza con becchi dritti
- 1 pinza con becchi a 90°
- 625 clips in plastica in 16 differenti misure
- clips contenute in 3 contenitori in PPL sovrapponibili



L mm 180 L1 mm 170 € 110,50 1 014780160

1478SP

assortimento 625 clips in plastica

16 tipologie differenti



€ 26,50 1 014780201

1479

estrattore per pioli

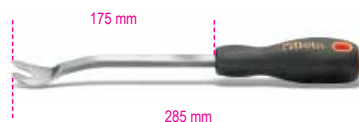

1479 € 27,00 2 014790001

1479/B27

kit di 27 attrezzi in nylon per pioli
e interventi su plastiche e guarnizioni
in busta appendibile



1479/B27 € 84,00 1 014790407

1479LB/C5

kit di 5 levapioli in metallo



1479LB/C5 € 114,50 1 014790150
215x165x50 mm

1479L/S2

coppia di leverini multifunzione
in Teflon®



1479L/S2 € 38,50 1 014790510

1479LV/S3

kit di 3 leverini multifunzione
in metallo

misure:

- 1479LV/1: 10x12 mm
- 1479LV/2: 4,8x9,6 mm
- 1479LV/3: 2,8x6 mm



1479LV/S3 € 32,50 1 014790100

1479L/K4

4 leverini per interventi
su cruscotti e parti delicate



1479L/K4 € 36,50 1 014790604

1479ML/B17

kit di 17 leverini multifunzione
in materiale plastico

particolarmente adatti per lavori di precisione



1479ML/B17 € 69,00 1 014790700

1479ML/S3

kit di 3 leverini multifunzione
in materiale plastico

Particolarmente adatti per lavori di precisione



1479ML/S3 € 11,80 1 014790603

1479N/S5

kit di 5 levapioli in nylon



1479N/S5 € 43,50 1 014790251

1479RB/1

raschietto a battere tipo diritto



1479RB/1 € 30,00 1 014790315

1479RB/2

raschietto a battere tipo piegato



1479RB/2 € 30,00 1 014790320

1479RB/3

raschietto a battere tipo piatto



1479RB/3 € 34,00 1 014790310

1479U/13

levapioli lama inox



1479U/13 € 27,50 2 014790010

1479U/32

levapioli lama inox



1479U/32 € 32,50 2 014790015

1480

kit riempimento filtri gasolio
per auto senza pompa elettrica

• Utilizzabile anche con pistola gonfiagomme

Il kit include:

- attacchi rapidi GM
- attacchi rapidi Renault, GM, Fiat Ø interno 6 mm
- attacchi rapidi Renault, GM, Fiat Ø interno 7 mm
- attacchi rapidi Ford
- attacchi rapidi PSA Ø interno 6 mm
- attacchi rapidi PSA Ø interno 7 mm
- attacchi rapidi Ford
- 2 adattatori conici per vetture senza attacchi rapidi



1480 € 408,00 1 014800010

410x320x70 mm

1481/C12

kit 6 coppie pinze per
occlusione tubazioni

- 2 coppie differenti pinze misura 1/4"
- 2 coppie differenti pinze misura 3/8"
- 2 coppie differenti pinze misura 5/16"
- 3 coppie tappi in gomma



1481/C12 € 129,00 1 014810312

370x270x59 mm

1481K/S4

kit di 4 morsetti autoserranti
per occlusione linee

misure:
5/16" - 3/8" - 1/2" e passante



1481K/S4 € 32,50 1 014810400

1481PL/A

pinza in plastica per occlusione tubi
e manicotti

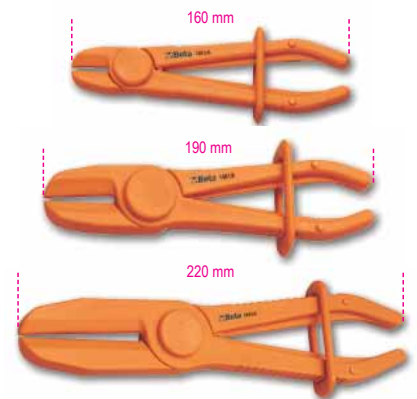

1481PL/A	Ø mm	€	1	014810110
1481PL/A	8÷15	22,10	3	014810110
1481PL/B	15÷25	24,80	3	014810120
1481PL/C	25÷45	33,50	3	014810130

1481PL/S3

serie di 3 pinze in plastica
per occlusione tubi e manicotti



1481PL/S3	€	1	014810200
1481PL-A Ø 8÷15 mm	80,50	1	014810200
1481PL-B Ø 15÷25 mm			
1481PL-C Ø 25÷45 mm			



1481T/C12

kit tappi di chiusura linee carburante

3 coppie di tappi con attacco rapido maschio/femmina per chiudere le linee carburante



1481T/C12 € 133,50 1 014810212
275x220x45 mm - 540 g

1482

chiave regolabile autoserrante per ghiera galleggianti serbatoio



Ø mm 89÷170 € 120,00 1 014820001
89÷200 € 125,50 1 014820002

1482A/1

chiave a 3 zampe per ghiera galleggianti serbatoio con ghiera in alluminio

per agire sulla ghiera in alluminio montata dal 2011 su vetture dei gruppi Fiat, Volkswagen, Opel, Chevrolet, Mercedes e BMW

12"



Ø mm 185 € 83,00 1 014820005

1482A/3

chiave per ghiera galleggianti serbatoio gruppo PSA

il disegno permette di operare sull'asse decentrato rimuovendo la ghiera, senza danneggiare il delicato pescante



Ø mm 157 € 94,50 1 014820007

1482A/5

chiave per ghiera galleggianti serbatoio a 22 settori

per agire sulla ghiera in plastica montata sulle vetture del gruppo VAG

12"



Ø mm 180 € 72,50 1 014820015

1482/8 - 1482/10

pinze per raccordi rapidi tubi carburante

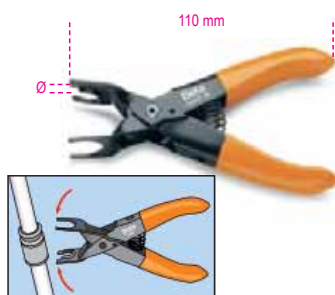

Ø mm 1482/8 8 € 41,50 2 014820008
1482/10 10 € 41,50 2 014820010

1482B

pinza per raccordi rapidi tubi carburante



1482B € 49,50 1 014820021

1482SN

pinza snodata per raccordi rapidi tubi carburante



L mm 260 € 63,50 1 014820110

1482C

2 coppie di cunei per sgancio raccordi filtri gasolio gruppo Fiat, Volkswagen, Jeep, Chrysler e Volvo

rapida sostituzione del filtro senza danneggiare irrimediabilmente i raccordi



1482C € 66,00 1 014820022

1482D

pinza con prolunga flessibile per raccordi rapidi tubi carburante



1482D € 90,50 1 014820026

1483K/12

kit per smontaggio valvole impianto aria condizionata con serie di inserti pentalobati

Il kit include:
• 2 bussole femmina ottagonali Ø 12 e 15 mm per valvole alta pressione
• 2 bussole maschio a forchetta sezione 2,2 e 3,2 mm per valvole a farfalla
• 1 serie di inserti pentalobati misura: PT10, PT15, PT20, PT25, PT27, PT30, PT40

14"

14"



1483K/12 € 43,50 1 014830012
120x80x35 mm

1483KV-PT/S7

serie di inserti pentalobati

misure include:
PT10 - PT15 - PT20 - PT25 - PT27 - PT30 - PT40

14"

14"



1483KV PT/S7 € 13,20 1 014830117

1483K/22

kit per la separazione di raccordi su impianti di condizionamento, alimentazione e lubrificazione



1483K/22 € 149,50 1 014830022
300x230x55 mm - 1 kg

1484

set di 2 utensili per la rimozione e il montaggio delle cinghie elastiche

Permette una rapida rimozione e un corretto montaggio della cinghia elastica senza rischio di danneggiamento



1484 € 132,50 1 014840010

1484PSA

attrezzo per il montaggio della cinghia elastica della pompa dell'acqua senza tendicinghia

utilizzabile per gruppo PSA e Opel motori 1.0 - 1.2



1484PSA € 17,30 1 014840012

1485BP

attrezzo a mezzaluna per bloccare pulegge dentate

regolabile tramite manico girevole, stringe e blocca la puleggia dall'esterno, evitando danni ai sensori circostanti



A Max mm 130 € 236,00 1 014850000

1485BPM

attrezzo a mezzaluna con ganasce in alluminio per bloccare pulegge multigola

regolabile tramite manico girevole, stringe e blocca la puleggia dall'esterno, evitando danni ai sensori circostanti



A Max mm 180 € 203,50 1 014850002

1485FCA/K2

coppia di attrezzi per precaricare cuscinetti cinghia di distribuzione gruppo FCA

indicati per motori 1.2, 1.4 8/16 V e 1.4 Multiair

- 1 attrezzo lungo 175 mm con puntali da 13,5 mm
- 1 attrezzo lungo 305 mm snodato con puntali da 13,5 mm



1485FCA/K2 € 108,00 1 014850220

1485FCA/T

attrezzo snodato per precaricare cuscinetti cinghia di distribuzione del gruppo FCA



L mm 175 P mm 13,3 € 39,00 1 014850210

1485FCA/TS

attrezzo per precaricare cuscinetti cinghia di distribuzione del gruppo FCA



L mm 305 P mm 13,5 € 69,00 1 014850215

1485FRD/T

leva per il tensionamento delle cinghie dei servizi, montate su motori Ford utilizzabile per la rimozione delle pulegge degli alternatori



L mm 450 Q mm 12,80 € 84,00 1 014850310

1485MRC/T

leva per il tensionamento delle cinghie dei servizi, montate su motori Mercedes utilizzabile per motori M133 - M270



L mm 510 Ø T55 € 34,50 1 014850315

1485VLV/T

leva per il tensionamento delle cinghie dei servizi, montate su motori Volvo

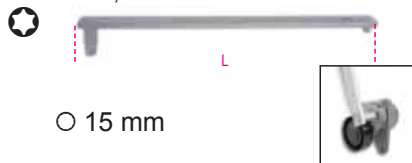

L mm 420 Ø T50-T60 Ø mm 15 € 71,00 1 014850320

1485TC

leva per il tensionamento delle cinghie dei servizi, montate su motori Ford, PSA, FCA



L mm 475 € 51,50 1 014850330

1485/KIT

kit attrezzi per controllo tensione cinghia distribuzione



1485/KIT € 191,50 1 014850100
230x140x75 mm - 580 g



1485MJ

attrezzo bloccaggio albero a camme motori 1.3 16V Multijet

2 teste con 3 profili per operare su tutti i motori 1.3 16V Multijet montati da gruppo FCA, Opel, Ford e Suzuki

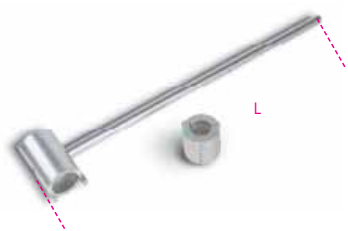

1485MJ	L mm 500	€ 132,50	1	014850150
--------	----------------	-------------	---	-----------

1485PMTJ

leva sbloccaggio pulegge albero motore Multijet

geometria appositamente studiata per bloccare l'albero motore durante le operazioni di rimozione della puleggia



1485PMTJ	L mm 450	€ 138,00	1	014850190
----------	----------------	-------------	---	-----------

1485R

attrezzo per rotazione pulegge distribuzione in acciaio forgiato con 2 coppie di puntali



1485R	Ø mm 30÷120	Ø1 mm 10 - 17	L mm 500	€ 165,00	1	014850025
-------	-------------------	---------------------	----------------	-------------	---	-----------

1485R/P10

coppie di puntali



1485R/P10	€ 17,70	1	014850035
-----------	------------	---	-----------

1485R/P17

coppie di puntali



1485R/P17	€ 17,70	1	014850038
-----------	------------	---	-----------

1485VAG/K2

coppia di attrezzi per precaricare i cuscinetti cinghia di distribuzione

- testa orientabile in 3 posizioni
- 1 attrezzo con testa profonda 12,5 mm
- 1 attrezzo con testa profonda 21,5 mm



1485VAG/K2	€ 82,00	1	014850080
------------	------------	---	-----------

1485VAG

attrezzi per precaricare cuscinetti cinghia di distribuzione

- testa orientabile in 3 posizioni



1485VAG/12,5	L mm 190	P mm 12,5	€ 40,50	1	014850062
1485VAG/21,5	L mm 195	P mm 21,5	€ 41,50	1	014850071

1487/K2

2 chiavi per tappi scarico radiatori



1487/K2	€ 29,50	1	014870100
---------	------------	---	-----------

1488 - 1488L

chiave snodata a catena doppia per filtri olio



1488	Ø mm 60÷110	€ 98,00	1	014880001
1488L	Ø mm 60÷160	€ 107,50	1	014880050

1488/1

chiave a catena doppia sottile per filtri olio



1488/1	Ø mm 60÷110	€ 113,50	1	014880010
--------	-------------------	-------------	---	-----------

1488R...

catena di ricambio



1488RC	1488	350	€ 40,50	1	014880101
1488R/L	1488/L	520	€ 65,00	1	014880150
1488RC/1	1488/1		€ 56,00	1	014880110

1489/31T

chiave per ruota libera puleggia alternatore



1489/31T	Ø mm T50	Ø mm 15	Ø mm 31	€ 41,50	1	014890016
----------	----------------	---------------	---------------	------------	---	-----------

1489/33

chiave per ruota libera puleggia alternatore Bosch



1489/33	Ø mm 33	€ 17,60	1	014890010
---------	---------------	------------	---	-----------



1489/33P

chiave per ruota libera puleggia nuovo alternatore Bosch FIAT Grande Punto



M 10 mm 31 € 52,50 1 014890015

1489/E

chiave per ruota libera puleggia alternatore



mm 10 mm 15 € 35,50 1 014890025

1489R

chiave per ruota libera puleggia alternatore Renault



1489/R € 17,60 1 014890020

1489/Y

chiave per ruota libera puleggia alternatori Nippondenso



mm 32 € 20,20 1 014890040

1489/C14

assortimento di 14 utensili per le pulegge libere degli alternatori



1489/C14 € 314,00 1 014890100

- 867PE 8 mm
- 867PE/L 8 mm
- 867XZN/L M10
- 867TX/L T50
- 867/2 □1/2"
- 920B 10 mm
- 1489/33
- 1489/33P M10
- 1489R
- 1489/Y
- 1489/31T T50
- 1489/E 10 mm
- 188 10 mm
- 188 15 mm

420x250x45 mm - 1,9 kg

1490

chiavi a nastro per filtri olio

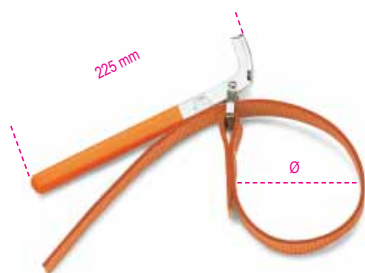

Ø max mm	€	1	014900001
1490/1 160	39,00		
1490/2 240	42,00	1	014900002

1490/R1 - 1490/R2

nastri in tessuto di ricambio per 1490



Ø mm	€	1	014900101
1490R/1 160	19,00		
1490R/2 240	23,20	1	014900102

1490F

chiavi a fascia per filtri



Ø Max mm 200 50 € 28,50 1 014900201

1491

chiave a nastro metallico regolabile per filtri olio



Ø mm 65÷110 € 50,50 2 014910001

1491R

nastro metallico di ricambio per 1491



1491R € 9,25 10 014910010

1491A

pinza regolabile per filtri olio

Regolazione di precisione mediante cremagliera



L mm 345 Ø min - Max mm 55 ÷ 140 € 34,50 1 014910040

1491T

pinza regolabile per filtri olio truck

Regolazione di precisione mediante cremagliera Utilizzabile per filtri essiccatori



L mm 500 Ø min - Max mm 70÷200 € 80,50 1 014910050



1492/1 - 1492/2

chiavi regolabili per filtri olio



	∅ mm	€		
1492/1	60÷80	48,00	1	014920001
1492/2	80÷110	50,00	1	014920002

1492T

chiavi per filtri essiccatori



	∅ mm	H mm	€		
1492T 40	125÷145	40	37,00	1	014920540
1492T 75	120÷140	75	65,00	1	014920575

1493B

chiavi poligonali per cartucce filtri olio di difficile accesso



mm	± mm	€		
24	8	20,80	1	014930524
27	8	21,70	1	014930527
32	8	22,20	1	014930532
36	8	23,80	1	014930536
38	8	24,30	1	014930538

1493B/S5

serie di 5 chiavi poligonali per cartucce filtri olio di difficile accesso

misure:
24-27-32-36-38 mm



1493B/S5	€			
	86,00	1	014930599	

1493

chiave a bussola per filtri olio

N=numero lati

12"



∅ mm	N	€		
65	14	11,80	1	014930200
73	14	11,80	1	014930208
74	14	11,80	1	014930209
74	15	11,80	1	014930210
76	14	11,80	1	014930218
76-74	15	12,80	1	014930220
78	15	12,80	1	014930224
80	15	13,10	1	014930226
82-80	15	13,10	1	014930228
86	16	13,90	1	014930230
90	15	13,90	1	014930234
92	10	13,90	1	014930236
93	15	13,90	1	014930238
100	15	15,80	1	014930248
106	15	16,40	1	014930250
108	15	16,40	1	014930252
135	18	26,50	1	014930256

1493/PF

chiavi a bussola per filtri olio Purflux

N=numero lati

12"



∅ mm	N	€		
66	6	11,80	1	014930202
76	12	11,80	1	014930216
76	30	12,80	1	014930222
86	18	13,90	1	014930232
93	36	13,90	1	014930240
93	45	13,90	1	014930242
96	18	13,90	1	014930246
108	18	17,70	1	014930254



1493/C30

serie di 28 chiavi a bussola per filtri olio

12"



Misure incluse nel kit (∅ mm / n° lati)

1493:

65/14 - 67/14 - 68/14 - 73/14 - 74/15
76/15 - 75.77/15 - 76/14 - 76/8 - 78/15 - 80/15
82/15 - 86/16 - 90/15 - 92/10 - 93/15 - 95/15
100/15 - 106/15 - 108/15

1493PF (Purflux)

66/6 - 76/12 - 76/30 - 86/18
93/36 - 93/45 - 96/18 - 108/18

- inclusa 1 chiave regolabile universale
∅ 65÷120 mm

1493/C30	€			
	286,00	1	014930000	

530x400x110 mm - 4 kg

1493AL

chiavi a bussola per filtri olio

N= numero lati

38"

12"

∅



∅ mm	N	●	□	€		
64	14	27	1/2"	17,70	1	014930310
66,5	14	27	1/2"	15,80	1	014930315
74	14	27	1/2"	19,20	1	014930320
79	15	27	3/8"	17,70	1	014930325
84	14	27	3/8"	19,20	1	014930330
87	16	27	1/2"	23,80	1	014930335
92	15	27	3/8"	19,20	1	014930340
100,5	15	27	3/8"	19,20	1	014930350

1493AL 4S

chiavi a bussola per filtri olio per auto asiatiche profilo a 4 settori

38"

∅

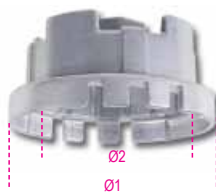

∅1 mm	∅2 mm	€		
70	64,5	27	1	014930304
80	64,5	27	1	014930305

1493AL CF

chiavi a bussola esagonale per cartucce filtri olio



Ø mm	H mm		€		
24	34	27	11,40	1	014930424
30	34	27	11,40	1	014930430
32,5	34	27	11,80	1	014930432
36	34	27	11,80	1	014930436
38	34	27	11,80	1	014930438

1493/C19

serie di 18 chiavi a bussola per filtri olio. particolarmente indicate per auto asiatiche

Misure incluse nella serie:

Ø mm	N lati
63-64	14
66,5	14
74	14
79	15
84	14
87	16
92	15
94,5	15
100,5	15

70 14 a settori per Toyota
80 14 a settori per Lexus

N° 6 bussole esagonali misura 24-27-30-32,5-36-38 mm per cartucce filtro

Il kit include 1 chiave regolabile universale Ø 58÷93 mm



1493/C19 € 250,00 1 014930019

490x450x60 mm - 4 kg

1493DSG

chiave per smontaggio/montaggio filtro olio cambio DSG



1493DSG € 39,50 1 014930800

1493FF

chiave per smontaggio/montaggio della sede in plastica di filtri olio Ford Peugeot Citroën motori: TDCi-HDi

permette di serrare correttamente la sede in plastica con chiave dinamometrica a 25 Nm.



1493FF € 32,50 1 014930127

1493FT

chiave per filtri gasolio Ford Transit

Utilizzabile su tutte le versioni Transit, Transit Custom e Tourneo Custom dal 2012



1493FT € 27,50 1 014930085

1493J

chiave per filtri gasolio Multijet

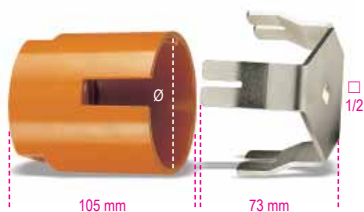

1493J € 125,50 1 014930080

1493VW

chiave per filtri gasolio gruppo VAG e Volvo



1493VW € 18,30 1 014930086

1493HK

chiave 15 lati per filtri gasolio Hyundai Kia



1493HK € 29,50 1 014930087

1493/C7

chiave autoregolabile a tre bracci per filtri olio destrorsa-sinistrorsa, con bracci intercambiabili

finitura diamantata anticivolo

2 serie di bracci:

- 1 serie con lunghezza utile 20 mm
- 1 serie con lunghezza utile 38 mm



1493/C7 € 121,50 1 014930079

210x150x50 mm

1493H

chiave autoregolabile a tre bracci per filtri olio destrorsa-sinistrorsa

Griffe godronate

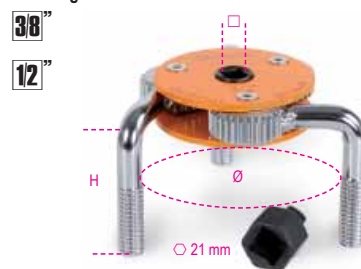

1493H € 30,00 1 014930077



1493/S-U

chiave autoregolabile a tre bracci per filtri olio destrorsa-sinistrorsa



	□	∅ mm	€	📦	📄
1493/S	3/8-1/2	80-115	91,00	1	014930074
1493/U	1/2	105-165	199,00	1	014930076

1493X

chiavi autoserranti per filtri olio sinistrorse

38"



	∅ mm	± mm	€	📦	📄
1493X/1	60÷80	2,9	34,50	1	014930105
1493X/2	80÷98	2,9	34,50	1	014930110

1493Y

chiavi autoserranti per filtri olio destrorse-sinistrorse versione pesante

l'articolo 1493Y/2 è utilizzabile anche per i filtri essiccatori

12"



	∅ mm	± mm	€	📦	📄
1493Y/1	80÷110	7,3	117,50	1	014930120
1493Y/2	104÷145	7,3	179,50	1	014930122

1493C/ADB

chiave per apertura tappo AdBlue® gruppo PSA

38"



1493C/ADB	17 mm	€ 17,90	📦 1	📄 014930900
-----------	-------	---------	-----	-------------

1493U/ADB

chiave apertura tappo di scarico AdBlue®

38"



1493U/ADB	17 mm	€ 12,90	📦 1	📄 014930910
-----------	-------	---------	-----	-------------

1494T/C5

kit chiavi speciali per tappi olio in plastica

includere nel kit:

- 1 chiave per tappi olio gruppo VAG
- 1 chiave per tappi olio BMW
- 1 chiave per tappi olio gruppo PSA e Ford
- 1 chiave per tappi olio Mercedes
- 1 chiave di manovra a "T"

38"



1494T/C5	17 mm	€ 78,00	📦 1	📄 014940350
📏 173x125x50 mm - 📖 360 g				

1494BMW

chiave speciale per tappi olio in plastica motori BMW

38"



1494BMW	17 mm	€ 15,10	📦 1	📄 014940315
---------	-------	---------	-----	-------------

1494FPC

chiave speciale per tappi olio in plastica motori Ford, Peugeot, Citroën

38"



1494FPC	17 mm	€ 17,10	📦 1	📄 014940320
---------	-------	---------	-----	-------------

1494VW

chiave speciale per tappi olio in plastica motori gruppo Volkswagen

permette di rimuovere e installare il tappo in plastica dalla coppa dell'olio. Specifico per vetture del gruppo Volkswagen con motori TFSI e TDI

38"



1494VW	17 mm	€ 23,80	📦 1	📄 014940305
--------	-------	---------	-----	-------------

1494MRC

chiave speciale per tappi olio in plastica motori Mercedes

38"



1494MRC	17 mm	€ 16,60	📦 1	📄 014940325
---------	-------	---------	-----	-------------

1494MAN

chiave speciale per tappi olio in plastica motori DAF e MAN

38"



1494MAN	17 mm	€ 16,60	📦 1	📄 014940330
---------	-------	---------	-----	-------------

1494

chiave a bussola quadrata per tappi olio motore

12"



mm 10	€ 9,90	📦 1	📄 014940280
-------	--------	-----	-------------

1494E

chiave a bussola maschio esagonale per tappi olio motore

12"



mm 8	€ 9,90	📦 1	📄 014940208
9	9,90	1	014940209
10	9,90	1	014940210
11	9,90	1	014940211
12	9,90	1	014940212
14	9,90	1	014940214
17	9,90	1	014940217



1494Q

chiavi a bussola maschio quadrato per tappi olio motore

12"



mm	€		
8	9,90	1	014940258
9,5	9,90	1	014940259
12	9,90	1	014940262
13	9,90	1	014940263

1494T

chiave a bussola maschio triangolare per tappi olio motore

12"



mm	€		
9,5	9,90	1	014940289

1494XZN

chiave a bussola maschio con profilo XZN® per tappi olio motore

12"



M	€		
16	11,80	1	014940296

1494VW/K

kit per sostituzione olio motore gruppo VAG



Contenuto del kit:
 • 1 chiave speciale per tappi in plastica
 • 6 tappi in plastica per coppa

1494VW/K	€		
	31,00	1	014940310

1494VW/KT

kit 6 tappi in plastica per 1494VW/K



1494VW/KT	€		
	27,00	1	014940311

1494/C14A

assortimento di 14 utensili per cambio olio

12"



1494/C14A	€		
	141,00	1	014940150

- 1494E 8-9-10-11-12-14-17
- 1494Q 8-9,5(3/8")-12-13
- 1494 10
- △ 1494T 9,5(3/8")
- 1494XZN M16

380x305x40 mm - 1,7 kg

1494M

attrezzo per tappi olio esagonali magnetico e flessibile

permette di svitare il tappo senza rischi di scottature e senza sporcarsi



L	F	Ø	€		
mm	kg	mm	25,50	1	014940401
293	2,5	19			

1495/C6

assortimento di utensili per la riparazione dei filetti della coppa olio



- Il filetto danneggiato viene rimosso con il maschio filettato e allargato di una misura
- Consente la riparazione ed evita la sostituzione della coppa olio

Composto da:

- 1 maschio M13x1.25 + 6 viti + 12 rondelle
- 1 maschio M13x1.5 + 6 viti + 12 rondelle
- 1 maschio M15x1.5 + 6 viti + 12 rondelle
- 1 maschio M17x1.5 + 6 viti + 12 rondelle
- 1 maschio M20x1.5 + 6 viti + 12 rondelle
- 1 maschio M22x1.5 + 6 viti + 12 rondelle

1495/C6	€		
	306,00	1	014950500

420x185x60 mm - 2,1 kg

1495M

maschio per filetti tappi olio



M	€		
13x1,25	18,40	1	014950553
13x1,50	15,10	1	014950563
15x1,50	16,40	1	014950565
17x1,50	18,40	1	014950567
20x1,50	20,30	1	014950570
22x1,50	26,50	1	014950572

1495T

kit di 6 tappi olio e rondelle



M	€		
13x1,25	21,50	1	014950503
13x1,50	21,50	1	014950513
15x1,50	21,50	1	014950515
17x1,50	23,80	1	014950517
20x1,50	27,00	1	014950520
22x1,50	35,00	1	014950522

1496/C

chiavi per tappi olio motore

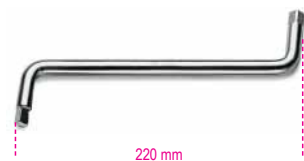

8 x 10 mm	€		
	23,40	3	014960010

1497D

pinza con becchi diritti per estrazione relé



A	€		
min=Max mm	35,50	1	014970150
15÷50			

1497BS

pinza con becchi dritti e sottili per estrazione relé e fusibili

I becchi lunghi e molto sottili permettono di rimuovere agevolmente relé e fusibili in spazi ristretti.

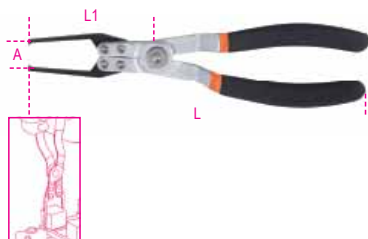

L	L1	A	€		
mm	mm	mm	24,60	1	014970190
230	45	14			

1497P

pinza con becchi piegati a 60° per estrazione relé



	A	€		
	min+Max	36,50	1	014970160
1497P	mm			
	15+50			

1497SS

pinza autobloccante per saldatura fili a stagno

Le clips superiori permettono di bloccare ed avvicinare i fili da saldare.

La cremagliera integrata permette di collocare i fili in sei posizioni differenti.



	A	€		
	min+Max	22,40	1	014970195
L	mm			
245	14+70			

1497TE

pinza per scollegamento connettori elettrici

I becchi molto fini permettono lo sblocco delle clip senza danneggiare i connettori



	L	A	Ø	€	
	mm	Max	mm	25,50	1
1497TE	215	63	4		014970180

1497/C23

assortimento di 23 utensili per sblocco connettori elettrici



1497/C23	€		
	239,00	1	014970200

440x250x70 mm - 1,7 kg

1497/C94

assortimento di 94 connettori per test su autovetture utilizzabili con i principali strumenti di diagnosi

- 2 rubacorrente
- 2 potenziometri
- 2 spie di segnalazione
- 2 connettori SRS
- 2 coccodrilli
- 2 sonde ad ago
- 2 puntali
- 2 connettori a banana doppi
- 4 connettori a banana singoli
- 24 terminali maschio piatti 0.6+6 mm
- 12 terminali maschio tondi 1.6+3.9 mm
- 24 terminali femmina piatti 0.6+6 mm
- 12 terminali femmina tondi 1.6+3.9 mm



1497/C94	€		
	421,00	1	014970300

430x390x100 mm - 3 kg

1497RC

coppia di rubacorrente

- sezione cavi: 1,5+3,5 mm
- voltaggio: 0+330V
- corrente massima 5A



1497RC	€		
	80,00	1	014970351

1497KB/S3

kit di 3 utensili per rimozione connettori elettrici Knorr e Bremse

- 1 utensile per connettori a baionetta
- 1 utensile con impronta per connettori a 2 poli
- 1 utensile con doppia impronta per connettori a 4 o 6 poli e 12 poli



1497KB/S3	€		
	88,00	1	014970050

1497/S3

serie di 3 cavetti per rilevazioni segnali elettrici

- 1 pz dritto
- 1 pz 45°
- 1 pz 90°



1497/S3	€		
	19,80	1	014970400

1498

provatensione

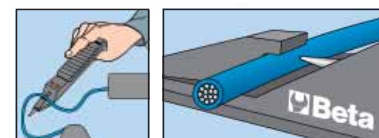

3+48V	€		
	53,00	2	014980100



AUTORIPARAZIONE

I nostri utensili per autoriparazione, usati dai professionisti più esigenti, sono sviluppati e prodotti per soddisfare gli standard più elevati al mondo e testati continuamente nelle condizioni di utilizzo più stressanti.

Da oltre 50 anni, siamo orgogliosamente a fianco dei più grandi campioni, che ci aiutano a migliorare costantemente i nostri prodotti e ne confermano il livello di qualità più assoluta.

Gli utensili dedicati all' autoriparazione si trovano in queste sezioni:

Diagnostica	da 1438 a 1499 da 1758VT a 1760TMC
Motore	da 955 a 989A da 1438 a 1499
Olio e filtri	da 1438 a 1499 da 1877 a 1885
Impianto elettrico	da 1438 a 1499
Avviatori	da 1498BC/12 a 1498/40A
Trasmissione	da 1438 a 1499
Sospensioni	da 1549 a 1569CP
Freni	da 1438 a 1499
Ruote	da 955 a 989A
Carrozzeria	da 1302 a 1369 da 1763 a 1767A
Altre attrezzature	da 1875LT a 3067
Sollevatori	da 3029/2T a 3067/70-13T



1498BC/12

avviatore portatile multifunzione 12V

Dati tecnici:

- Corrente di spunto: 1500A
- Capacità batteria 25000mAh
- Tipo di batteria: 4 celle LifePo4
- Corrente di avviamento: 600A
- Dispositivo di protezione contro inversione di polarità, corto circuito, sovracorrente, carica eccessiva e sovratensione termica



Dotazione:

- Custodia protettiva
- Cavo con pinze di avviamento
- Uscite USB per caricare dispositivi elettronici
- Indicatore led di carica della batteria
- Cavo USB e USB-C
- Alimentatore da rete
- Torcia LED multifunzione

	L	P	H	€		
	mm	mm	mm			
1498BC/12	225	100	40	350,00	1	014980040

1498MN/12-C

cavo di avviamento con pinze per 1498BC/12



1498MN/12-C	62,50	1	014980005
-------------	-------	---	-----------

1498MN/12-R

alimentatori di rete mini avviatore 1498BC/12



1498MN/12-R	46,00	1	014980003
-------------	-------	---	-----------

1498MN/12-P

alimentatore presa auto mini avviatori 1498BC/12



1498MN/12-P	28,00	1	014980004
-------------	-------	---	-----------

1498MN/12-U

cavi USB con adattatori universali per 1498BC/12



1498MN/12-U	20,30	1	014980009
-------------	-------	---	-----------

1498LT/12

avviatore portatile ultraleggero ad alte prestazioni



Dati tecnici:

- Tensione di utilizzo: 12 V
- Amperaggio continuo: 800 A
- Amperaggio massimo di avviamento: 2000 A
- Amperaggio di picco: 4000 A
- Lunghezza cavi: 500 mm
- Tipo batteria: 4 celle LifePo4
- Funzione Salva memoria: SI
- Dimensioni: 260 x 135 x 72 mm
- Peso netto: 2,5 kg
- Dotato di alimentatore di ricarica 12 V 1,3A

1498LT/12	891,00	1	014980012
-----------	--------	---	-----------

1498LT/12-SF

staffa di fissaggio a parete per avviatore 1498LT/12



1498LT/12-SF	148,00	1	014980013
--------------	--------	---	-----------

1498LT/12-R7

alimentatore di rete per avviatore 1498LT/12



1498LT/12-R7	64,50	1	014980057
--------------	-------	---	-----------

1498LT/12-24

avvitore portatile ultraleggero ad alte prestazioni 12-24 V

indicato per utilizzo su auto, veicoli commerciali e truck



Il microprocessore permette la totale protezione contro:

- Inversione di polarità
- Corto circuito
- Voltaggio errato
- Sovraccarico
- Sottoscarica
- Sovraccarica
- Sovratemperatura

Dati tecnici:

- Tensione di utilizzo 12/24V
- Amperaggio continuo 2000/1000 A
- Amperaggio massimo di avviamento 5000/2500 A
- Amperaggio di picco 10000/5000 A
- Amperaggio pinze 1000 A
- Lunghezza cavi 160 cm
- Sezione cavi 25mm²
- Alimentatore automatico 4 Amp
- Funzione salvamemoria
- Dimensioni 350x240x140 mm
- Peso 5 kg

1498LT/12-24 € 1.770,00 1 014980014

1498/12

avvitore per auto 12V portatile



DATI TECNICI:

- Corrente di spunto 2200A
- Tracolla per trasporto inclusa
- Batteria ermetica al piombo electrolyte solido (AGM)

1498/12 € 745,00 1 014980480

13 kg

1498/24

avvitore per auto e veicoli commerciali 12-24V portatile



Dati tecnici:

- Corrente di spunto 4200A (12V) - 2100A (24V)
- Tracolla per trasporto inclusa
- Batteria ermetica al piombo electrolyte solido (AGM)
- Peso 17 Kg

1498/24 € 1.500,00 1 014980490

1498B12/R02

batteria di ricambio 12V per avviatori 12-24V



1498B12-R02 € 324,00 1 014980502

1498/12-24 R20

alimentatore di rete per avvitore 1498/12 e 1498/24



1498/12-24 R20 € 78,00 1 014980520



1498/2A

caricabatterie elettronico 12V per motocicli

permette la carica di tutti i tipi di batterie al Pb Wet, Agm, Gel, Mf, Vrla e delle batterie al Litio LiFePo4



Caratteristiche:

- Due specifici tipi di carica per batterie al Litio e al Piombo
- Ciclo di ricarica multifase automatico
- Protezione contro inversione di polarità e corto circuito
- Grado di protezione IP65
- Include cavo con pinze e cavo con occhielli
- Tensione di alimentazione: 220-240V

Dati tecnici:

- Corrente di ricarica: 1A
- Capacità di ricarica: 2Ah-40Ah
- Frequenza: 50-60 Hz
- Tensione della batteria: 12V
- Dimensioni: 180x80x40 mm
- Peso: 0,5 Kg

1498/2A € 138,00 1 014980102

1498/4A

caricabatterie elettronico 6-12V auto-moto



Dati tecnici:

- Tensione di alimentazione: 220V-240V
- Frequenza: 50-60 Hz
- Corrente nominale (min-max): 1-4 Amp
- Tensione della batteria: 6V/12V
- Capacità batteria: 4Ah-80Ah
- Tempo di ricarica: 12 ore
- Grado di protezione: IP65

1498/4A € 167,00 1 014980104

1498SA/2A-4A

cavo con presa accendisigari per 1498/2A e 1498/4A



1498SA/2A-4A € 35,00 1 014980120

1498/8A

caricabatterie elettronico 12V auto-veicoli commerciali



Caratteristiche:

- Carica lenta e veloce (2A-8A)
- Funzione recupero batterie scariche
- Funzione alimentatore 13,8V-5A
- Protezione di inversione polarità e corto circuito
- Selezione manuale tipo batteria
- Display digitale retroilluminato
- Gancio di fissaggio reclinabile

Dati tecnici:

- Tensione di alimentazione: 220V - 240V
- Frequenza: 50-60 Hz
- Corrente nominale (min-max): 2-8 Amp
- Tensione della batteria: 12V
- Capacità batteria: 5Ah-160Ah
- Funzione Memory Saver: 13,8V - 5A
- Grado di protezione: IP65

1498/8A € 236,00 1 014980108

1498/4A-8A CO

cavo ad occhiali per 1498/2A - /4A



1498/4A-8A-CO € 16,90 1 014980114

1498/4A-8A CP

cavo con pinze per 1498/2A - /4A - /8A



1498/4A-8A-CP € 21,70 1 014980118

1498/2A-8A-PR

prolunga per 1498/2A/4A/8A



1498/2A-8A-PR € 40,50 1 014980119

1498/16A

caricabatterie elettronico 12-24V multifunzione



Caratteristiche:

- Display grafico retroilluminato
- Corrente massima di carica 16A continui
- Carica e mantenimento
- Protezione contro inversione polarità, corto circuito
- 9 fasi di ricarica
- Floating system
- Funzione SHOW ROOM (13,8V - 12A)
- Funzione SUPPLY (14V - 12A)
- Funzione memory saver (13,8V - 12A)
- Funzione recupero batterie
- Porta pinze
- Gancio di fissaggio reclinabile
- Inclusi accessori: cavo con pinza, cavo con occhiali

Dati tecnici:

- Alimentazione: 220-240V
- Potenza: 240W
- Corrente di carica: 4-16A
- Tipo batterie: Agm - Wet - Lithium (LiFePo4)
- Capacità di carica: 5-360Ah
- Capacità di mantenimento: 5-550Ah
- Tensione in uscita: 12-24V
- Tensione minima batteria: 0,8V
- Grado di protezione: IP20

1498/16A € 496,00 1 014980126

1498/25A

caricabatterie elettronico 12-24V multifunzione



Caratteristiche:

- Display grafico retroilluminato
- Corrente massima di carica 25A continui
- Carica e mantenimento
- Protezione contro inversione polarità, corto circuito
- 9 fasi di ricarica
- Floating system
- Funzione SHOW ROOM (13,8V - 21A)
- Funzione SUPPLY (14V - 21A)
- Funzione memory saver (13,8V - 21A)
- Funzione recupero batterie
- Porta pinze
- Gancio di fissaggio reclinabile
- Inclusi accessori: cavo con pinza

Dati tecnici:

- Alimentazione: 220-240V
- Potenza: 390W
- Corrente di carica: 5-25A
- Tipo batterie: Agm - Wet - Lithium (LiFePo4)
- Capacità di carica: 5-550Ah
- Capacità di mantenimento: 5-800Ah
- Tensione in uscita: 12-24V
- Tensione minima batteria: 0,8V
- Grado di protezione: IP20

1498/25A L mm H mm P mm € 584,00 1 014980125



1498/120A

caricabatterie elettronico
12V multifunzione

Permette la carica delle batterie
e l'alimentazione dei veicoli durante
tutte le fasi di riprogrammazione e autodiagnosi



CE

120A



Alimentatore
Power supply
ECU
Protocollo diagnosi

Pb Wet, Gel
Dry, Agm
LiFePo4 LITHIUM

- corrente massima di carica 120A continui
- carica e mantenimento con microprocessore CPU
- funzione recupero batterie
- riprogrammazione e alimentazione ECU
- protezione contro inversione polarità, corto circuito, voltaggio errato e sovraccarico

DATI TECNICI

Alimentazione: 90-260V
 Potenza: 1500W
 Corrente di carica: 10-120A
 Tipo batterie: Agm - Wet - Lithium (LifePo4)
 Capacità di carica: 10-1200Ah
 Capacità di mantenimento: 5-3600Ah
 Tensione in uscita: 12V
 Lunghezza cavi con pinze: 2700 mm
 Dimensioni: 310 x 150 x 350 mm
 Peso: 8,5 Kg

1498/120A € 3.080,00 1 014980142

1498/40A

caricabatterie avviatore multifunzione 12-24V
carrellato

non avendo una batteria interna, la funzione di avviamento
(max 350A) non sostituisce quella di un avviatore specifico
tipo 1498LT/12 (2000A)



CE



- 3 cicli di carica programmati e 1 ciclo manuale
- potenziometro di regolazione elettronica
- processi specifici di carica WET-SPIRAL/GEL-AGM
- sistema di controllo e protezione elettronico
- processo di carica a 10 fasi
- funzione desolfatazione e recupero batteria
- funzione supply
- doppia tensione 12-24V
- idoneo anche per batterie Start&Stop
- pinze professionali in ottone isolate in gomma

DATI TECNICI

Alimentazione: 230V
 Tensione in uscita: 12-24V
 Corrente di carica: 1-40A
 Corrente di avviamento: 350A max cc
 Capacità di ricarica: 4-450Ah

1498/40A € 1.250,00 1 014980140

330x250x792

1498SM

salva memorie 12 V

evita la perdita dei dati memorizzati dal computer di bordo
delle autovetture durante le operazioni di manutenzione o
sostituzione della batteria.



CE



DATI TECNICI:

- autoalimentato
- batteria interna Pb 5 Ah
- 12 Volt
- connessione professionale con presa OBD

1498SM € 267,00 1 014980020

1498SM-C

cavi memorie auto OBD II 12V per 1498SM/C



1498SM-C € 79,00 1 014980021

1498SM-CP

cavi memorie auto pinza 12V 1498SM/CP



1498SM-CP € 27,00 1 014980022

1498SM-A

alimentatori salva memorie 1498SM/A



1498SM-A € 30,00 1 014980023

1498TB/6-12

tester analogico per batteria 6 - 12V

permette l'analisi delle batterie da 6V e 12V fino a 1000CCA



TABELLA LETTURA RISULTATI TEST

OK (VERDE):
La capacità della batteria è ok, la batteria potrebbe essere carica
o non completamente carica. Ricaricare completamente la
batteria.

WEAK o BAD, ma l'ago rimane fisso (GIALLO o ROSSO):
La capacità della batteria non è soddisfacente. La batteria può
essere difettosa o non completamente carica. Se la ricarica non
avviene al 100%, la batteria deve essere sostituita.

WEAK o BAD, ma l'ago non rimane in posizione (GIALLO o
ROSSO):
La batteria potrebbe essere difettosa o completamente esaurita.
Sostituire la batteria.

L L1 P
mm mm mm € 62,00 1 014980420



1498TB/12-24

tester digitale per batteria 12V
e analizzatore sistema di avviamento e ricarica
12-24V

- permette di effettuare i seguenti test: batteria, alternatore (intelligente e normale) e avviamento, ripple di diodo e prova di messa a terra
- dotato di software per stampare il test eseguito da PC
- display retroilluminato
- struttura compatta e antiurto
- software in 10 lingue
- dotato di un apposito ingresso per il collegamento di una mini stampante estraibile (accessorio opzionale Beta 1498ST/TB)



CE

Dati tecnici:

- Applicazioni: Test batterie 12V - Test alternatore 12-24V carica - Test sistemi avviamento
- Intervallo di funzionamento: 100-2000 CCA
- Normative di riferimento: CCA,SAE,DIN,EN,IEC,JIS
- Batterie supportate: PB, WET, GEL, AGM, AGM FLAT, EFB
- Voltmetro: 9V-36V
- Lunghezza cavi: 1600 mm
- Lingue: Italiano, Inglese, Francese, Tedesco, Spagnolo, Polacco, Rumeno, Olandese, Svedese e Finlandese
- Accessori inclusi: Cavo USB e Software

1498TB/12-24 € 714,00 1 014980401

1498ST/TB

mini stampante termica
per Tester 1498TB/12 e 1498TB/12-24

- possibilità di collegare la mini stampante direttamente sul tester
- permette di stampare i risultati del test effettuato



CE

1498ST/TB € 256,00 1 014980410

1498ST/TB ROT

ricambio carta
per stampante 1498ST/TB



1498ST/TB ROT € 12,40 2 014980411

1498PC

stabilizzatore di tensione 12-24 V

Indispensabile per proteggere le centraline
in fase di saldatura ed avviamenti con avviatori



1498PC € 106,00 1 014980801

1499

stetoscopio



1499 € 107,00 1 014990001

1500/...

estrattori universali
a due griffe

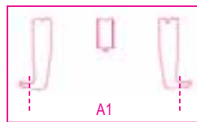

	L mm	€		
1500/1	100	89,50	1	015000301
1500/2	100	93,50	1	015000302
1500/3	150	155,50	1	015000303
1500/4	150	213,50	1	015000304
1500/5	205	388,00	1	015000305
1500/6	205	455,00	1	015000306
1500/7	205	681,00	1	015000307
1500/8	230	1.090,00	1	015000308

	A min+Max mm	A1 min+Max mm
1500/1	25÷80	70÷130
1500/2	25÷130	80÷180
1500/3	50÷160	105÷220
1500/4	60÷200	120÷270
1500/5	80÷250	160÷330
1500/6	80÷350	160÷420
1500/7	110÷520	195÷600
1500/8	170÷640	260÷715



1500/SP5 € 1.004,00 1 015000325
1500/1-1500/2-1500/3
1500/4-1500/5
1500/SPV € 87,50 1 015000001

1500G/...

coppia di griffe tipo normale
per 1500 e 1580/8I



	mm	1500	€		
1500G/1	35	/1-2	57,50	1	015000311
1500G/3	35	/3-4	85,00	1	015000313
1500G/5	35	/5-6-7	172,50	1	015000315
1500G/8	50	/8	212,00	1	015000317
		1580/8I			

1500N/...

estrattori universali
a 2 griffe scorrevoli

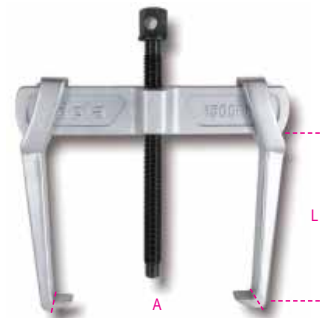

	A min+Max mm	L mm	€		
1500N0	18÷65	70	80,00	1	015000600
1500N1	23÷70	100	83,50	1	015000601
1500N2	23÷100	100	90,50	1	015000602
1500N3	35÷140	150	150,50	1	015000603
1500N4	35÷190	150	162,00	1	015000604
1500N5	43÷250	205	312,00	1	015000605
1500N6	43÷320	205	338,00	1	015000606



1500N/SP6	878,00	1	015000626
1500N/0-1500N/1-1500N/2-1500N/3			
1500N/4-1500N/5			
1500N/SPV	106,00	1	015000006

1500N/G...

griffe per estrattori 1500N



	mm	1500N	€		
1500N/G0	10	/0	26,50	2	015000650
1500N/G1-2	12	/1-2	28,00	2	015000651
1500N/G3-4	17	/3-4	49,50	2	015000653
1500N/G5-6	23	/5-6	97,50	2	015000655

1501/1 - 2 - 3

estrattori a griffe sottili

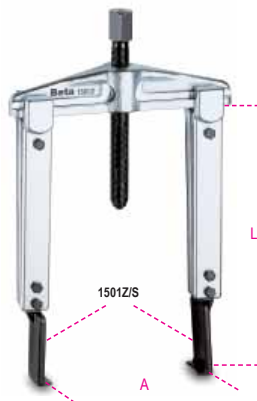

	L mm	€		
1501/1	100	201,50	1	015010101
1501/2	200	213,50	1	015010102
1501/3	250	224,50	1	015010103

	A min+Max mm
1501/1	25÷130
1501/2	25÷130
1501/3	25÷130



1501G/1 - 2 - 3

coppie di griffe per 1501



	L mm	€		
1501G/1	100	111,00	1	015010111
1501G/2	200	129,00	1	015010112
1501G/3	250	140,00	1	015010113

1501Z/S - P - R

terminali per griffe 1501G



	mm	D mm	€		
1501ZS	2,0	27	39,50	2	015010211
1501ZP	3,6	27	40,50	2	015010212
1501ZR	3,6	14	45,50	2	015010213

1502/...

estrattori universali a due griffe con regolazione e chiusura rapida delle griffe

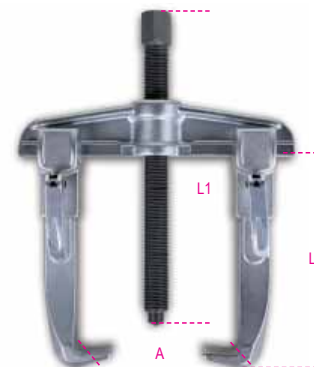

	L mm	L1 mm	€		
1502/0	100	166	132,50	1	015020000
1502/1	100	166	144,00	1	015020001
1502/2	150	247	228,50	1	015020002
1502/3	150	247	253,00	1	015020003
1502/4	200	321	434,00	1	015020004

	A min+Max mm	A1 min+Max mm
1502/0	40÷90	80÷130
1502/1	50÷130	90÷170
1502/2	65÷150	115÷210
1502/3	65÷190	125÷260
1502/4	70÷235	170÷335

1505V

estrattore per bracci tergilicristalli e tergilunotti

puntale in ottone forato removibile per estrazione bracci con ugello lavavetro integrato



	A Max mm	L mm	€		
1505V	43	37	46,50	1	015050001

1505/C5

kit per estrazione tergitricristalli

1 estrattore a 2 griffe Ø 25÷40 mm
4 mezzalune Ø 25 mm, Ø 30 mm, Ø 35 mm, Ø 41 mm



mm 12 € 156,50 1 015050300

320x150x60 mm - 1,2 kg

1506

estrattore autoserrante a due griffe

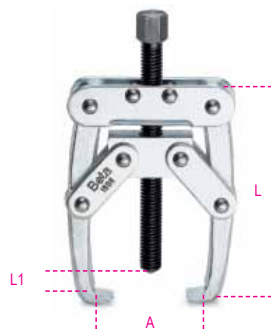

A	L	L1	€	1	015060001
min+Max mm	mm	mm			
10÷50	80	40	48,00		

1508/1 - 1508/2

estrattori a due griffe tipo leggero



L	€	1	015080001
mm			
1508/1 105	160,50		
1508/2 130	191,00		

A	L1
min+Max mm	mm
1508/1 6÷100	85
1508/2 10÷140	120

1511/1 - 2 - 3

estrattori a due griffe reversibili per esterni

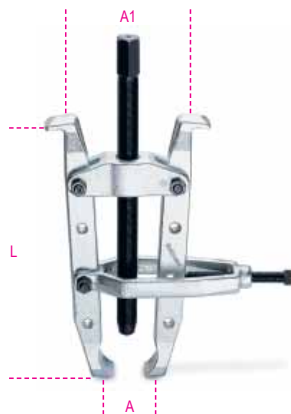

L	€	1	015110001
mm			
1511/1 235	272,00		
1511/2 330	340,00		
1511/3 405	422,00		

A	A1
min+Max mm	min+Max mm
1511/1 20÷100	65÷95
1511/2 40÷150	103÷190
1511/3 40÷150	103÷175

1515/1 - 2 - 3

estrattori a due griffe oscillanti



L	€	1	015150101
mm			
1515/1 85	35,50		
1515/2 85	37,50		
1515/3 105	56,50		

A	L1
Max mm	mm
1515/1 60	105
1515/2 70	105
1515/3 90	105

1516/1 - 2 - 3

estrattori a tre griffe oscillanti



L	€	1	015160001
mm			
1516/1 85	51,50		
1516/2 85	55,00		
1516/3 105	78,00		

A	L1
Max mm	mm
1516/1 60	85
1516/2 70	85
1516/3 90	105

1517

estrattori 3 griffe autoserranti

- per elevati carichi d' estrazione.
- effetto autoserrante.



L	L1	€	1	015170000
mm	mm			
1517/90 182	60	279,00		
1517/150 242	115	286,00		
1517/200 307	150	330,00		
1517/260 395	180	383,00		

mm	A	kg	N
1517/90 19	18÷90	6000	59000
1517/150 19	25÷150	6000	59000
1517/200 19	40÷200	6000	59000
1517/260 27	50÷260	8000	78500



1517C ESTRATTORI AUTOSERRANTI PER ESTERNI A 2 O 3 GRIFFE

L'estrattore Beta 1517C opera con il serraggio automatico delle griffe grazie alla molla presente sulla traversa. Questa caratteristica facilita il posizionamento ed il bloccaggio dell'estrattore sul particolare da estrarre. Una volta posizionato, le griffe si possono bloccare tramite la ghiera.

La particolare traversa presente sull'1517C ha 4 sedi che permettono all'estrattore di poter essere utilizzato sia con 2 griffe, per un lavoro più facile e veloce, oppure con 3 griffe per una maggiore stabilità di lavoro.

La spina di sicurezza posizionata in testa alla vite si rompe al superamento della coppia massima consentita, salvaguardando così l'estrattore da sovraccarichi.

1517C/...

estrattori combinati a due o tre griffe autoserranti

- per un utilizzo a 2 oppure a 3 griffe.
- effetto autoserrante.



	L mm	L1 mm	€		
1517C/0	145	250	236,00	1	015170500
1517C/1	200	300	290,00	1	015170501
1517C/2	270	300	360,00	1	015170502

	A mm	● mm
1517C/0	12÷140	18
1517C/1	20÷180	18
1517C/2	30÷280	18

1518/...

estrattori a tre griffe



	L mm	€		
1518/1	105	86,50	1	015180001
1518/2	135	110,50	1	015180002
1518/3	235	195,50	1	015180003
1518/4	270	291,00	1	015180004
1518/5	270	342,00	1	015180005
1518/6	270	358,00	1	015180006

	A min=Max mm	L1 mm
1518/1	24÷100	105
1518/2	32÷160	150
1518/3	40÷220	220
1518/4	80÷250	240
1518/5	80÷300	350
1518/6	80÷350	400

1518U/...

estrattori universali
a tre griffe

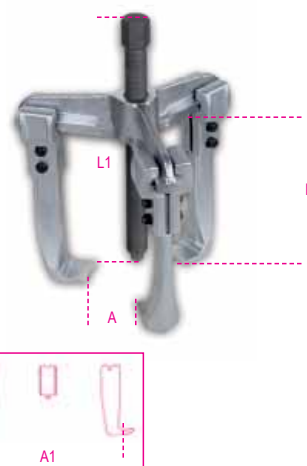

	L mm	L1 mm	€		
1518U/0	100	166	163,00	1	015180500
1518U/1	100	166	174,50	1	015180501
1518U/2	150	247	265,00	1	015180502
1518U/3	150	247	277,00	1	015180503
1518U/4	200	321	400,00	1	015180504

	A min=Max mm	A1 min=Max mm	● mm
1518U/0	40÷90	80÷130	17
1518U/1	50÷130	90÷170	17
1518U/2	65÷150	115÷210	22
1518U/3	65÷190	125÷260	22
1518U/4	70÷235	170÷335	27

1519/...

estrattori universali
a tre griffe

con regolazione e chiusura rapida delle griffe

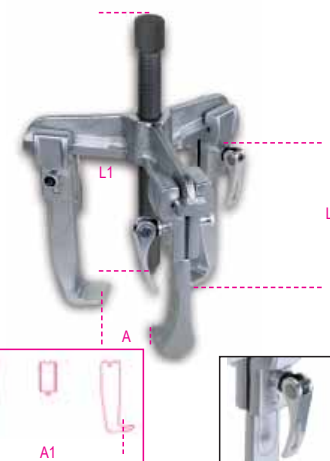

	L mm	L1 mm	€		
1519/0	100	166	188,00	1	015190000
1519/1	100	166	199,50	1	015190001
1519/2	150	247	285,00	1	015190002
1519/3	150	247	302,00	1	015190003

	A min=Max mm	A1 min=Max mm	● mm
1519/0	40÷90	80÷130	17
1519/1	50÷130	90÷170	17
1519/2	65÷150	115÷210	22
1519/3	65÷190	125÷260	22



1520/1 - 1520/2

estrattori a due griffe reversibili

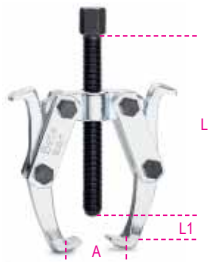

	L mm	€	1	015200101
1520/1	135	82,00		
1520/2	235	140,00		015200102

	A Max mm	L1 mm
1520/1	110	85
1520/2	160	140

1521/1 - 1521/2

estrattori a tre griffe reversibili



	L mm	€	1	015210101
1521/1	135	106,00		
1521/2	235	186,50		015210102

	A Max mm	L1 mm
1521/1	110	90
1521/2	160	140

1528

estrattore autoserrante per dischi freno



∅ 19 mm

	A min+Max mm	€	1	015280000
	170÷ 380	189,00		

480x240x60 mm - 4,8 kg

1529

estrattore per pulegge multigola

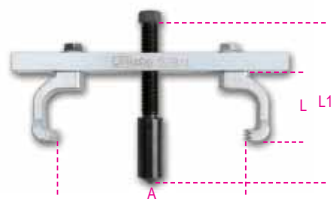

	A min+Max mm	L min+Max mm	L1 min+Max mm	€	1	015290000
	24÷240	60÷95	90÷135	277,00		

260x210x60 mm - 2,6 kg

1529/C7

estrattore per pulegge

Incluse nel kit:

- 2 griffe con doppio piede spesso 4,7 mm
 - 2 griffe a singolo piede spesso 4,3 mm
 - 1 griffa con doppio piede spesso 2,3 mm
 - 1 griffa a singolo piede spesso 2,3 mm
- La coppia di griffe è componibile in base all'esigenza operativa



	L mm	L1 mm	A min+Max mm	€	1	015290100
1529/C7	50	72,5	53÷114	161,50		

285x155x50 mm - 2 kg

1529PI

estrattore universale per puleggia pompa iniezione

- permette un rapido e preciso smontaggio della puleggia pompa iniezione carburante.
- particolarmente indicato per Fiat, Ford, Volkswagen, Citroen e Peugeot

Incluse 3 coppie di viti per serrare l'estrattore alla puleggia:

- M6 x 1.0 x 49 mm
- M7 x 1.0 x 75 mm
- M8 x 1.25 x 76 mm



1529PI	115,50	1	015290051
--------	--------	---	-----------

1529/PG

estrattore per pompa alta pressione gasolio vetture gruppo VAG



	∅ mm	€	1	015290010
	15-24	71,00		

1530/C5

kit per estrazione mozzi e cuscinetti ruote a 3, 4, 5 fori

Il kit comprende:

- 1 flangia universale 96÷138 mm
- 1 vite idraulica da 12 tonnellate
- 1 massa battente da 2,8 kg indispensabile per mozzetti senza bullone di fissaggio centrale



1530/C5	583,00	1	015300300
---------	--------	---	-----------

760x320x120 mm - 11,5 kg

1530/C16

kit a massa battente con colonnette distanziatrici, per estrazione mozzi e cuscinetti ruote a 3, 4, 5 fori

Ideale per mozzi con anello di centraggio sporgente

il kit comprende:

- 1 flangia universale 90÷130 mm
- 1 massa battente da 5 kg
- 4 colonnette attacco M12
- 4 colonnette attacco M14



1530/C16	717,00	1	015300316
----------	--------	---	-----------

760x310x100 mm - 13,5 kg

1531/C7

kit estrazione anello interno
cuscinetto ruota dal mozzo

misure incluse:

- 1 pinza Ø 40÷45 mm
- 1 pinza Ø 45÷51 mm
- 1 pinza Ø 50÷55 mm
- 1 pinza Ø 55÷61 mm



1531/C7 € 788,00 1 015310107

390x315x96 mm - 4,3 kg

1532

utensile per rimozione guarnizioni
e paraoli



1532 € 18,30 2 015320001

1533/...

tiranti per separatori 1534



	L mm	€		
1533/2	150	119,00	1	015330002
1533/3	210	226,50	1	015330003
1533/4	315	359,00	1	015330004
1533/5A	305	434,00	1	015330006

	A min=Max mm	L1 mm
1533/2	45÷140	110
1533/3	55÷205	175
1533/4	90÷260	175
1533/5A	100÷360	235

1533PR/1 - 2 - 3

prolunghe per tiranti 1533



	€		
1533PR/1 1533/2	26,00	1	015330011
1533PR/2 1533/3	28,00	1	015330012
1533PR/3 1533/4	29,50	1	015330013
1533PR/5A 1533/5A	29,50	1	015330016

1534/...

separatori

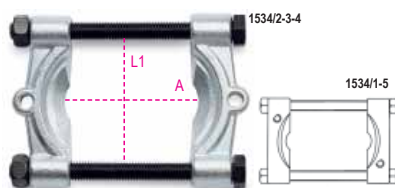

		€		
1534/1	1533/2	103,50	1	015340001
1534/2	1533/2	122,50	1	015340002
1534/3	1533/3	203,50	1	015340003
1534/4	1533/4	342,00	1	015340004
1534/5A	1533/5A	704,00	1	015340006

	A min=Max mm	L1 mm
1534/1	5÷60	63
1534/2	12÷75	75
1534/3	22÷115	118
1534/4	25÷155	154
1534/5A	30÷220	180

1535/C...

estrattori combinati



1535/C1 € 332,00 1 015350001

260x180x40 mm - 2,5 kg

1535/C2 € 351,00 1 015350002

260x180x40 mm - 2,8 kg

1535/C3 € 576,00 1 015350003

380x280x55 mm - 8,0 kg

1535/C4 € 890,00 1 015350004

420x380x65 mm - 14,8 kg

1535/C5A € 1.350,00 1 015350006

530x510x85 mm - 27,2 kg

1539

tiramier a percussione



1539 € 181,00 1 015390001

1540

estrattore a percussione

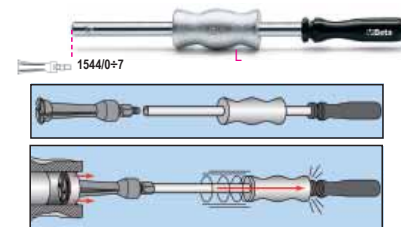

1540 L 390 mm, M10, 1544 0÷7 € 101,50 1 015400001



1542/1 - 1542/2

estrattori per griffe ed espansori



	A min+Max mm	1544	€		
1542/1	35÷75	0÷7	87,50	1	015420001
1542/2	60÷130	9C-10C	131,50	1	015420002

	L mm	L1 mm
1542/1	140	140
1542/2	175	160

1544/...

espansori a settori per interni

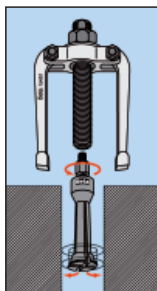

	C mm	M	€		
1544/0	0,25	M10	77,00	1	015440100
A= 5÷7					
1544/A	0,80	M10	80,00	1	015440105
A= 7÷9					
1544/1	0,80	M10	82,00	1	015440110
A= 9÷12					
1544/2	1,15	M10	84,00	1	015440120
A= 13÷17					
1544/2B	1,00	M10	86,00	1	015440121
A= 14÷19					
1544/3	1,70	M10	88,50	1	015440130
A= 16÷21					
1544/4	1,65	M10	98,00	1	015440140
A= 20÷25					
1544/5	2,00	M10	105,00	1	015440150
A= 25÷30					
1544/6	3,00	M10	131,50	1	015440160
A= 30÷37					
1544/7	3,80	M10	149,00	1	015440170
A= 38÷45					
1544/9C	2,60	G 3/8"	216,00	1	015440189
A= 40÷75					
1544/10C	7,30	G 3/8"	298,00	1	015440199
A= 70÷115					

1545/C5M

estrattore 1542/1 con 5 espansori 1544



	€		
1545/C5M	585,00	1	015450011

1542/1	● 24 mm
1544/1	9÷12 mm
1544/2	13÷17 mm
1544/3	16÷21 mm
1544/4	20÷25 mm
1544/5	25÷30 mm

265x180x45 mm - 2,4 kg

1547/C6

estrattori per cuscinetti con false sfere

Cuscinetti:
1547/1
6011-6014, 6206-6211, 6303-6308, 6403-6405
1547/2
6004-6010, 6200-6205, 6300-6304

• utilizzabile solo dopo aver "sgabbiato" le sfere.

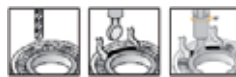

	€		
1547/C6	301,00	1	015470006

420x185x60 mm - 3 kg

1547KP

set di 3 coppie di terminali a falsa sfera



	∅ mm	€		
1547KP/1	9-11-12,5	47,50	1	015470106
1547KP/2	5-6-8	33,00	1	015470206

1547P

prolunghe esagonali



	L mm	€		
1547P/1	205	10,30	1	015470101
1547P/2	102	6,55	1	015470201

1547PC/2

prolunghe tonde corte



	L mm	€		
1547PC/2	42	5,30	1	015470202

1547PL/2

prolunghe tonde lunghe



	L mm	€		
1547PL/2	106	5,90	1	015470203

1549

kit per smontaggio e montaggio ammortizzatori a doppio effetto con rientro a gas

permette di mantenere lo stelo in estensione durante il montaggio delle molle



	€		
1549	415,00	1	015490001

310x270x110 mm - 3 kg

1550U

smonta ammortizzatori pneumatico per autoveicoli, SUV e veicoli commerciali

CE

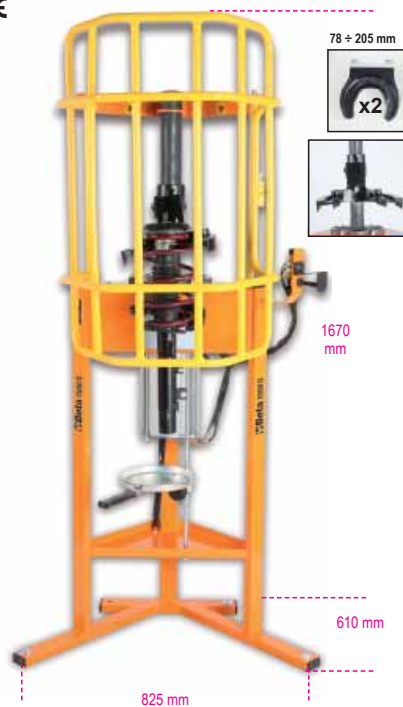

Caratteristiche:

- Potenza di spinta pari a 2 ton (10 bar), 1.6 ton (8 bar), 1.2 ton (6 bar)
- Corsa di compressione molla 335 mm
- Sistema universale di presa superiore che consente di comprimere tutti i diametri di molla, sia destrorse sia sinistrorse, con un'unica piastra adattabile superiore
- Sistema di sicurezza attivo sulla molla che, attraverso il gancio di sicurezza e le 3 valvole di blocco, garantisce il suo corretto funzionamento, mantenendo tale posizione per tutta la durata dell'operazione di compressione (il sistema ferma la macchina nel caso di posizionamento errato della molla)
- Griglia di protezione "Full Body" per garantire la massima sicurezza e copertura della zona di lavoro
- Azionamento con leva di comando per una maggiore precisione e sensibilità durante la fase di compressione
- Altezza di lavoro sulla staffa posteriore alzata fino a 875 mm
- Fornita di 2 staffe inferiori per diametri 78-205 mm

1550U € 3.160,00 1 015500010

1550U/CGS-R

coppia ganasce superiori ribassate per 1550U



1550U/CGS-R € 608,00 1 015500035

1550U/MRC-ABE

staffe speciali per 1550U specifiche per Mercedes Classe A-B-E



1550U/MRC-ABE € 627,00 1 015500031

1550U/MRC-C

staffe speciali per 1550U specifiche per Mercedes Classe C



1550U/MRC-C € 551,00 1 015500032

1550U/S...

staffa inferiore per 1550U



	Ø mm	€		
1550U/S 130	78÷130 mm	399,00	1	015500014
1550U/S 182	105÷182 mm	399,00	1	015500015
1550U/S 205	125÷205 mm	399,00	1	015500016

1550U/SS187

staffa sinistrorsa per 1550U

particolarmente indicata per molle con profilo sinistro tipo Nissan Qashqai e Renault Koleos



1550U/SS 187 € 399,00 1 015500018

1550U/M

morsa per smonta ammortizzatori 1550U

permette il bloccaggio dello stelo dell'ammortizzatore



1550U/M € 379,00 1 015500021

1551/C20

kit per smontaggio teste ammortizzatori

inclusi nel kit:

- 7 bussole esagonali misure: 16 - 17 - 18 - 19 - 21 - 22 - 24
- 1 prolunga porta bussola lunga 120 mm
- 3 inserti femmina con cava misure: 8x5 - 8x6 - 11x8
- 1 inserto femmina esagonale misura: 10 mm
- 1 inserto maschio XZN® misura: M10
- 1 inserto maschio Torx® misura: T50
- 4 inserti maschio esagonali misure: 5 - 6 - 7 - 8
- 1 prolunga porta inserti lunga 95 mm
- 1 prolunga porta inserti lunga 190 mm



1551/C20 € 167,00 1 015510020

320x245x71 mm - 2,6 kg

1552/C9

kit per divaricare i giunti di ammortizzatori, bracci oscillanti e sterzo

è possibile lavorare con testa a singolo o doppio divaricatore, in modo da poter operare anche sui giunti doppi tipo gruppo VAG



1552/C9 € 132,50 1 015520020

195x140x40 mm - 1,0 kg



1555/Q

pressore per molle ammortizzatori MacPherson ed equivalenti

spinta massima 1800 Kg

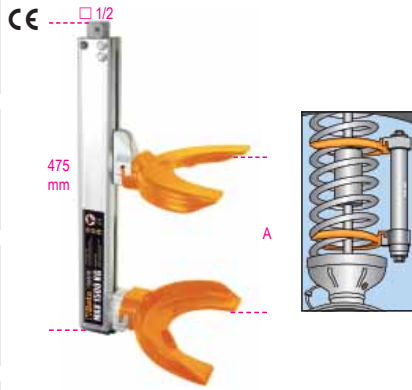

CE	□ 1/2				
A	∅	€			
min+Max	min+Max				
mm	mm				
65÷354	80÷195	864,00		1	015550006

1555/QS

pressore per molle ammortizzatori Mac Pherson ed equivalenti
Dotato di protezioni in plastica per l'utilizzo in morsa

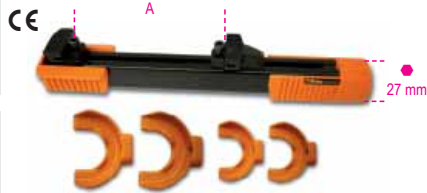

CE	□ 1/2				
A	∅	€			
min+Max	min+Max				
mm	mm				
70÷300	80÷200	1.064,00		1	015550005

1555S/BMW-RNT

staffa per ammortizzatori BMW E39, E46 e Renault Megane II per 1555Q e 1555/QS



1555S/BMW-RNT	€				
	334,00			1	015550303

1555C

pressore telescopico per molle ammortizzatori con 4 staffe e barra di torsione



12"					
A	∅	N	t	€	
min+Max	min+Max				
mm	mm				
80÷225	90÷160	25000	8,5	1.025,00	1 015550202

1556/1A

coppia di pressori per molle ammortizzatori

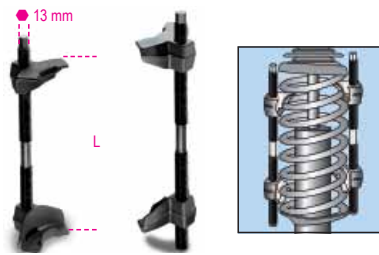

min L Max	€				
mm					
65÷320	249,00			1	015560101

1556/2A

coppia di pressori per molle ammortizzatori

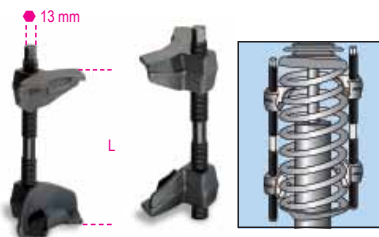

min L Max	€				
mm					
65÷200	246,00			1	015560102

1557

chiavi a bussola Macchina per perni balestre Truck



34"					
L	L1	€			
mm	mm				
37	28	92,50		1	015570137
46	34	94,50		1	015570146
56	34	102,50		1	015570156

1557V

chiave a bussola Macchina per perni balestre Truck Volvo



●	€				
mm					
27	48,00			1	015570299

1557/S3

serie di 3 chiavi per ghiera ammortizzatori

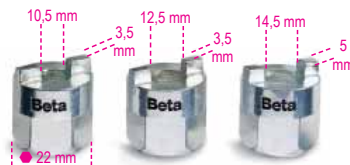

1557/S3	€				
	72,00			1	015570010

1558/C4

attrezzo per anelli seeger interni ed esterni con azionamento a vite

grazie all'attacco quadro si applica una forza elevata in entrambe le condizioni d'utilizzo
Puntali in dotazione:
∅ 2,5-3-3,5 mm



∅ mm	∅ mm	€			
1558/C4	5,5÷77	5,5÷77	178,00		1 015580100
	330x220x50 mm				900 g

1558P

coppia puntali anelli seeger per 1558



∅ mm	€				
2,5	9,00			1	015580125
3,0	9,00			1	015580130
3,5	9,00			1	015580135

1558/C13

attrezzo per anelli seeger interni ed esterni con azionamento a vite

grazie all'attacco quadro si applica una forza elevata in entrambe le condizioni d'utilizzo

Puntali in dotazione:
• dritti: ∅ 2,5 - 3 - 3,5 - 3,8 mm
• 45°: ∅ 2,5 - 3 - 3,5 - 3,8 mm
• 90°: ∅ 2,5 - 3 - 3,5 - 3,8 mm

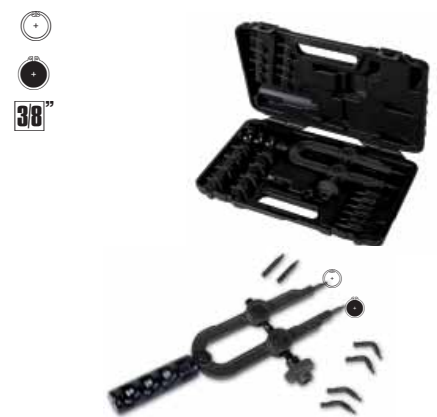

∅ mm	∅ mm	€			
1558/C13	5,5÷77	5,5÷77	238,50		1 015580200
	330x220x45 mm				1,6 kg

1559

estrattori per snodi sferici



	A Max mm	Ø mm	€		
1559/22	50	18÷22	92,00	1	015590001
1559/36	90	36	423,00	1	015590036
1559/45	115	45	634,00	1	015590045

1559V/8T

vite idraulica per estrattore snodi sferici
1559/36 e 1559/45

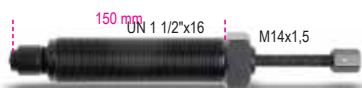

Nm	t	€		
80000	8	320,00	1	015590145

1560/2

estrattori per snodi sferici
modello professionale



	A min+Max mm	Ø mm	€		
1560/2	60÷85	20	197,00	1	015600002

1560A

estrattore per snodi sferici



	€		
1560A	264,00	1	015600601

1561/...

estrattori per snodi sferici



	L mm	A mm	Ø mm	€		
1561/1	39	36,6	18	71,50	1	015610001
1561/2	47	45,7	25	93,50	1	015610002
1561/3	63	62	30	136,00	1	015610003
1561/4	75	63	40	172,50	1	015610004

1562D

estrattore per snodi sferici

Fornito con 2 viti per l'estrazione di giunti sospensione e sterzo



A max mm	Ø mm	● mm	L mm	€		
50	39	26	155	359,00	1	015620239

1563/C4

kit 4 bussole per estrazione
snodi sferici

utilizzare con scalpellatore
include nel kit:

- 1 bussola M12x1,25 mm
- 1 bussola M12x1,5 mm
- 1 bussola M14x1,5 mm
- 1 bussola M16x1,5 mm



22/24 mm

	€		
1563/C4	51,50	1	015630010

1565/1 - 2 - 3

estrattori a percussione
per snodi sferici



	Ø mm	L1 mm	€		
1565/1	18	65	81,50	1	015650001
1565/2	23	65	92,00	1	015650002
1565/3	30	88	96,00	1	015650003

1566N

attrezzo per smontaggio/montaggio
braccetti sterzo



Ø x L mm	○ mm	□ mm	€		
28÷35 x 400	27	12"	130,00	1	015660005
35÷45 x 190	27	-	130,00	1	015660008
35÷45 x 400	27	12"	146,00	1	015660010

1566R

attrezzo regolabile per smontaggio/montaggio
braccetti sterzo



Ø mm	€		
27÷43	24,90	1	015660015

1566/G01

estrattore per giunti omocinetici

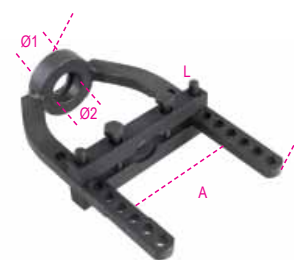

L mm	A mm	Ø1 mm	Ø2 mm	€		
250	115	29	36	155,00	1	015660052

1566P

pinza per anelli elastici
millerighe semiassi

la pinza comprime l'anello elastico semplificando
l'inserimento del semiassi nel giunto omocinetico



L mm	A Max mm	€		
280	36	70,50	1	015660091

1567

leva per estrazione testine braccio oscillante
e ammortizzatori dal montante

Utilizzabile da un solo operatore



A mm	B min+Max mm	€		
1060	100÷300	356,00	1	015670001

1568

attrezzo pneumatico per installazione
cuffie semiassi in silicone
8 griffe con apertura massima di 145 mm

CE



L mm	L1 mm	€	1	015680001
420	195	254,00		

1569/F

assortimento di utensili per l'estrazione e
l'introduzione
dei silent block di Fiat Panda, Panda 4x4,
Panda Metano e Cross, Fiat 500, Ford Ka e
Opel Adam



1569/F	€	1	015690021
	469,00		

1569/SB

assortimento di utensili per l'estrazione e
l'introduzione di: silent block ponte posteriore,
paraoli albero motore e cuscinetti ruota

• le boccole possono essere utilizzate sia direttamente sul
veicolo che alla pressa idraulica



1569/SB	€	1	015690016
	263,00		

425x365x100 mm - 13 kg

1569CP

insertori a percussione
per cuscinetti conici e paraoli

regolazione rapida



	Ø min+Max mm	L mm	€	1	015690750
1569CP/50	9,5÷50	130	139,00		
1569CP/90	18÷90	145	172,50		015690790

1570/3

martinetto idraulico per estrattori



t	L mm	L1 mm	● mm	€	1	015700003
30	243	36	19	256,00		

1580/8I

estrattore universale
idraulico a due griffe

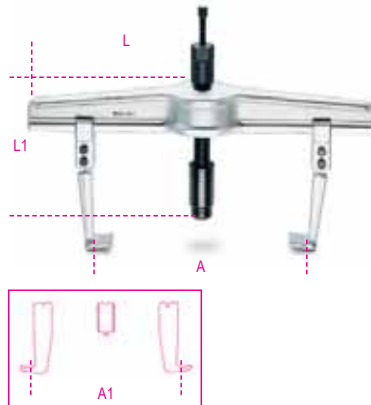

1580/8I	€	1	015800008
	1.640,00		

	A min+Max mm	L mm	L1 mm	A1 min+Max mm	N Max
1580/8I	170÷640	715	280	260÷715	180000

1580GL

griffe tipo lungo per estrattori 1580/8I - 1500/8



	L mm	€	1	015800227
1580GL/8A	300	185,00		
1580GL/8B	400	206,00		015800228
1580GL/8C	500	263,00		015800229

1585/5I - 6I - 7I

estrattori a tre griffe
per azionamento idraulico

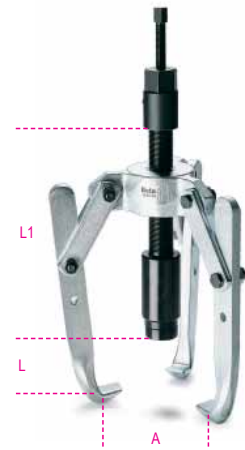

1585/5I	€	1	015850005
1585/6I	1.140,00		015850006
1585/7I	1.199,00		015850007
	1.235,00		

	A min+Max mm	L1 mm	L mm	N Max
1585/5I	50÷350	135	280	150000
1585/6I	50÷350	235	280	150000
1585/7I	50÷350	335	280	150000

1585GI/5 - 6 - 7

griffe per estrattori idraulici
1585/5I - 1585/6I - 1585/7I

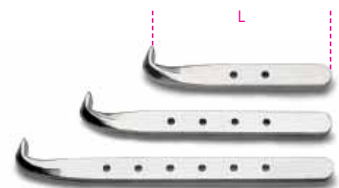

	L mm	€	1	015850205
1585GI/5	135	103,50		
1585GI/6	235	122,50		015850206
1585GI/7	335	148,50		015850207

1589VI

vite idraulica per estrattori 1580/8I
e 1585/5I - 1585/6I - 1585/7I

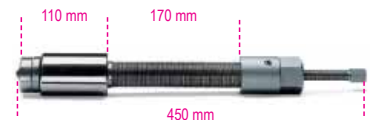

1589VI	€	1	015890001
	672,00		

1589PI/50 - 100 - 150

prolunghe per vite idraulica



	L mm	L1 mm	€	1	015890005
1589PI/50	50	70	61,00		
1589PI/100	100	120	67,00		015890010
1589PI/150	150	170	73,00		015890015

1590 morsetti standard



A max mm	L1 mm	€		
60	55	28,00	2	015900305
100	65	45,00	2	015900310
150	95	74,50	2	015900315

1591 stretti a vite



A ~	A max mm	L1 mm	€		
200	200	80	29,50	2	015910020
300	310	85	36,00	2	015910030
400	410	85	39,00	2	015910040
500	500	95	52,50	2	015910050
600	600	95	53,50	2	015910060
800	800	95	65,00	2	015910080
1000	1000	110	81,50	2	015910100

1593 serragianti a vite

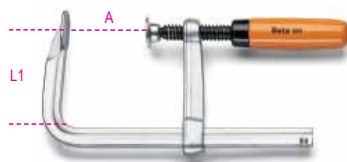

A ~	A max mm	L1 mm	€		
160	170	80	35,00	2	015930016
200	240	100	53,50	2	015930020
300	320	145	75,00	2	015930030

1594 serragianti a leva

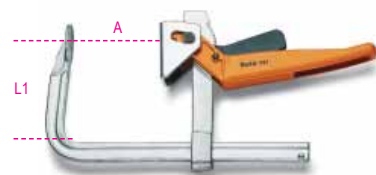

A ~	A max mm	L1 mm	€		
200	240	145	116,50	1	015940020
250	290	145	121,00	1	015940025
300	340	145	129,50	1	015940030
400	430	150	135,50	1	015940040
500	530	150	142,50	1	015940050
600	630	150	149,50	1	015940060

1595 serragianti a vite

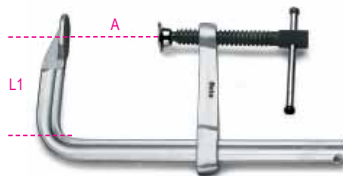

A ~	A max mm	L1 mm	€		
200	230	100	55,50	2	015950020
250	270	120	60,50	2	015950025
300	330	120	77,00	2	015950030
400	420	120	86,50	2	015950040
500	520	125	94,00	2	015950050
600	620	125	99,50	2	015950060
800	820	125	118,00	1	015950080
1000	1030	125	131,00	1	015950100

1599F Morse parallele da banco forgiate

Interamente in fusione di acciaio. Ganasce fresate e temprate in superficie.
Apertura anteriore. Elevata profondità di serraggio.



L1 mm	BxH mm	Ø mm	A MAX mm	€		
100	92x46	11	125	345,00	1	015990100
125	108x54	13	150	441,00	1	015990125
150	125x62	13	200	619,00	1	015990150
175	140x70	15	220	845,00	1	015990175

1599GI morse parallele da banco con ganasce intercambiabili

- con guida quadrata per lavori impegnativi
- ganasce intercambiabili con superficie temprata

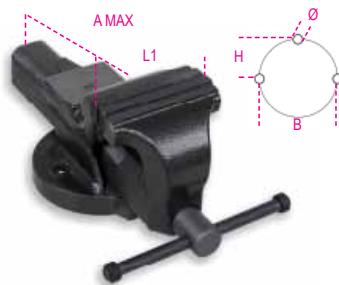

L1 mm	BxH mm	Ø mm	A MAX mm	€		
100	92x46	11	125	266,00	1	015990200
125	108x54	13	150	366,00	1	015990225
150	125x62	13	200	500,00	1	015990250
175	140x70	15	220	667,00	1	015990275

1599GR coppie di ganasce e viti di ricambio per morse 1599GI



A mm	€		
1599GR 100	100	25,50	1 015990920
1599GR 125	125	32,00	1 015990925
1599GR 150	150	39,00	1 015990950
1599GR 175	175	45,50	1 015990975

1599P Morse parallele da banco

Ganasce temperate.
Incudine con ampia superficie verniciata.
Base quadrata in acciaio.

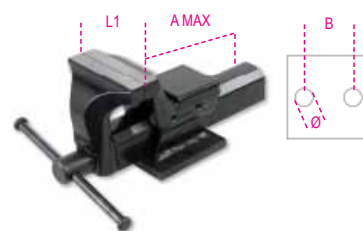

L1 mm	B mm	Ø mm	A MAX mm	€		
100	92	11	111	303,00	1	015990000
125	108	13	130	364,00	1	015990025
150	130	15	170	507,00	1	015990050

1599B basi girevoli rotonde per morse 1599P



L1 mm	1599P mm	€		
1599B 100	100	126,50	1	015990810
1599B 125	125	144,00	1	015990812
1599B 150	150	178,00	1	015990815

1599T morse parallele per trapano

Morse in ghisa speciale, con ganasce temprate e rettificata.
Applicabili sui piccoli e medi trapani a colonna

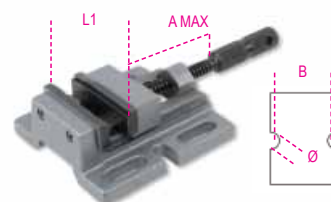

L1 mm	B mm	Ø mm	A MAX mm	€		
80	111	11	65	171,00	1	015990480
100	120	13	87	212,00	1	015990500

1599G

coppie di copri-gasce in alluminio

- magnetiche su tutta la lunghezza
- con fresatura interna per il bloccaggio di parti filettate



A mm	€	Icona	Articolo
100	55,50	1	015990910
125	57,50	1	015990912
150	63,00	1	015990915
180	70,00	1	015990917

1600Q 8

chiave a croce per quadristi

quadro da 5 / 6 / 7-8 mm
 triangolo da 7 / 9 mm
 alette 3-5 mm
 esagono 1/4"
 inserto doppio con intaglio 1,0x7 mm e impronta a croce PH2



L mm	€	Icona	Articolo
76	31,00	1	016000008

1600Q 10

chiave snodabile a doppia croce per quadristi

quadro da 5 / 6-7 / 8-9 mm
 triangolo da 5-6-7 / 8-9 / 10 mm
 alette 3-5 mm
 esagono 1/4"
 quadro maschio 1/4"



L mm	€	Icona	Articolo
125	39,50	1	016000010

SERVIZIO DI CERTIFICAZIONE STRUMENTI DI MISURA

La certificazione degli strumenti di misura è indispensabile in quei settori o ambiti di applicazione in cui è necessario conoscere e controllare l'esattezza della misura in modo inequivocabile e riconoscibile. La certificazione prevede il rilascio di un certificato Accredia:

Beta Utensili S.p.A. fornisce su richiesta il servizio di certificazione di Calibri corsoio e digitali, Comparatori, Micrometri e Tastatori. Per usufruire di questo servizio rivolgeti al tuo rivenditore di fiducia.



1650

calibro a corsoio
 lettura ventesimale

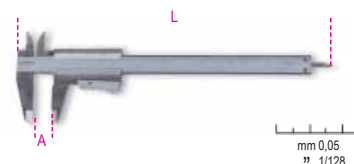

UNI EN ISO 13385-1DIN 862

A max mm	L mm	€	Icona	Articolo
150	235	64,50	1	016500001
200	290	85,00	1	016500002

1650FD

calibro a corsoio per dischi freni
 lettura decimale

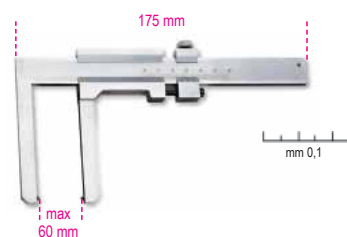

Articolo	€	Icona	Articolo
1650FD	229,00	1	016500050

1650FT

calibro a corsoio per tamburi freni
 lettura ventesimale



Articolo	A max mm	L mm	€	Icona	Articolo
1650FT/1	350	438	429,00	1	016500060
1650FT/2	500	550	749,00	1	016500070

1651DGTB

calibro digitale a corsoio
 lettura centesimale

Caratteristiche:

- Lettura centesimale
- Bloccaggio a vite del corsoio
- Conversione mm/pollici
- Azzeramento in ogni posizione
- Asta di profondità quadra fino a 300mm
- In astuccio rigido di materiale plastico

CE

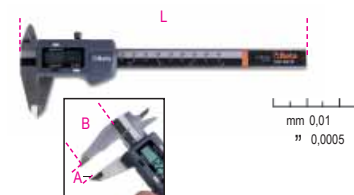

UNI EN ISO 13385-1DIN 862CE

A Max mm	L mm	B mm	€	Icona	Articolo
150	235	40	109,00	1	016510211
200	285	50	142,00	1	016510212
300	400	60	185,50	1	016510213



1651DGTB/IP

calibro digitale a corsoio
lettura centesimale grado di protezione IP67

- Lettura centesimale
- Bloccaggio a vite del corsoio
- Conversione mm/pollici
- Accensione automatica con il movimento del corsoio
- Azzeramento in ogni posizione
- Funzione HOLD
- Opzione di scelta tra misura assoluta e incrementale

Il grado di protezione IP67 garantisce una totale protezione dalle polveri e dai liquidi, preservando le caratteristiche funzionali del calibro anche in caso di totale immersione

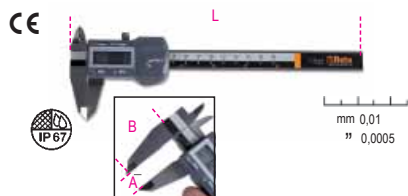

UNI EN ISO 13385-1 DIN 862CE

A Max mm	L mm	B mm	€	1	016510711
150	235	40	178,00	1	016510711

≡ 270x115x35 mm - 450 g

1652

calibro a corsoio con comparatore
lettura cinquantessimale



UNI EN ISO 13385-1DIN 862

1652	€	1	016520016
	136,50	1	016520016

1654

calibri a corsoio
lettura cinquantessimale



UNI EN ISO 13385-1DIN 862

A max mm	L mm	€	1	016540020
200	330	299,00	1	016540020
300	410	406,00	1	016540030



1654DGT

calibro digitale a corsoio
lettura centesimale

- Lettura centesimale
- Bloccaggio a vite del corsoio
- Conversione mm/pollici

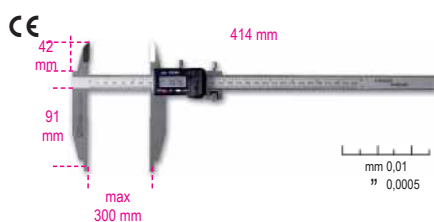

UNI EN ISO 13385-1DIN 862CE

1654DGT	€	1	016540111
	685,00	1	016540111

1656

calibri a corsoio di profondità
lettura cinquantessimale



UNI EN ISO 13385-2DIN 862

A max mm	L mm	€	1	016560020
200	260	142,00	1	016560020
300	360	208,50	1	016560030

1657DGT/2

calibro a corsoio di profondità digitale
lettura centesimale

- Lettura centesimale
- Bloccaggio a vite del corsoio
- Conversione mm/pollici

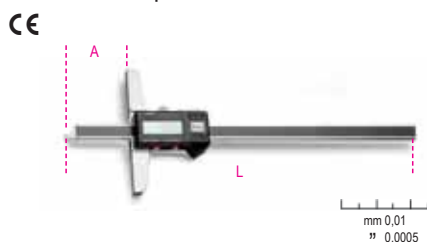

UNI EN ISO 13385-2DIN 862CE

1657DGT/2	A max mm	L mm	€	1	016570002
	200	270	264,00	1	016570002

1658/...

micrometri per esterni
lettura centesimale



DIN 863/II

	A mm	€	1	016580025
1658/25	0÷25	81,50	1	016580025
1658/50	25÷50	88,50	1	016580050
1658/75	50÷75	100,00	1	016580075
1658/100	75÷100	109,50	1	016580100

1658/C4

assortimento di 4 micrometri 1658



DIN 863

1658/C4	€	1	016580001
	328,00	1	016580001

1658/25 0÷25 mm

1658/50 25÷50 mm

1658/75 50÷75 mm

1658/100 75÷100 mm

≡ 365x245x35 mm - 2,5 kg

1658DGTB

micrometri digitali per esterni IP65
lettura millesimale

- Lettura millesimale
- Contatti in metallo duro
- Bloccaggio corsoio tramite leva
- Conversione mm/pollici
- Azzeramento in ogni posizione
- Opzione di scelta tra misura assoluta e incrementale
- Chiave di regolazione nella confezione



DIN 863CE

1658DGTB 25	€	1	016580525
	222,50	1	016580525
1658DGTB 50	277,00	1	016580550



1658SP/1

supporto per micrometro

- Morsetto con inserti in gomma
- Rotazione a 90°



1658SP/1 € 56,50 1 016580910

1659

misuratore di spessore con comparatore lettura centesimale

C = Campo di comparazione



1659 C mm 0÷10 € 209,50 1 016590001

1662/1 - 1662/2

comparatori

lettura centesimale

C = Campo di comparazione



DIN 878
1662/1 C mm 0÷5 € 96,00 1 016620001
1662/2 C mm 0÷10 € 117,00 1 016620010

1662DGT/A

comparatore digitale

lettura centesimale

C = Campo di comparazione

CE



1662DGT/A C mm 0-12,5 € 291,00 1 016620311

1662AN

comparatore a tastatore orientabile lettura centesimale

C = Campo di comparazione



DIN 2270
1662AN C mm 0÷0,8 € 227,00 1 016620200

1662SP0

supporto a base magnetica



1662SP0 € 81,00 1 016620800

1662SP2

supporto a base magnetica snodato



1662SP2 € 146,50 1 016620910

1666

squadre semplici in acciaio inossidabile rettificata e lappate



DIN 875/0
L mm L1 mm € 1 016660210
100 70 66,50
150 100 96,50
200 130 115,50
250 165 149,50
300 200 188,50

1666A

squadre a cappello in acciaio inossidabile rettificata e lappate



DIN 875/0
L mm L1 mm € 1 016660110
100 70 97,50
150 100 132,00
200 130 186,00
250 170 231,00
300 200 292,00

1668

squadre semplici in acciaio normalizzato rettificata



DIN 875/2
L mm L1 mm € 1 016680210
100 70 29,50
150 100 39,00
200 130 51,00
250 165 74,00
300 174 91,00



1668A

squadre a cappello
in acciaio normalizzato
rettificate



DIN 875/2

L mm	L1 mm	€		
100	70	35,00	2	016680110
150	100	54,00	2	016680115
200	130	68,50	2	016680120
250	165	98,50	1	016680125
300	176	117,50	1	016680130

1670

squadre semplici
in acciaio non normale



L mm	L1 mm	€		
100	70	18,30	3	016700010
150	100	19,10	3	016700015
200	130	21,50	3	016700020
250	160	23,50	3	016700025
300	175	26,00	3	016700030
400	230	38,50	2	016700040
500	280	43,00	2	016700050
600	330	45,50	2	016700060
800	420	62,00	1	016700080
1000	500	74,00	1	016700099

1670A

squadre a cappello
in acciaio non normale



L mm	L1 mm	€		
100	70	24,00	3	016700110
150	100	26,00	3	016700115
200	130	28,00	3	016700120
250	165	34,00	3	016700125
300	175	40,00	3	016700130
400	230	52,50	2	016700140
500	280	70,00	2	016700150
600	330	78,50	2	016700160
800	420	93,00	1	016700180
1000	500	115,50	1	016700199

1672

squadra falsa
a lama orientabile e scorrevole
lama e base in acciaio

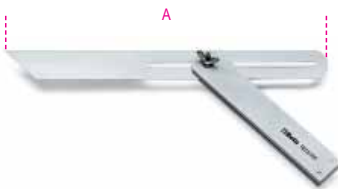

A mm	€		
300	56,00	2	016720030

1672A

squadre false
a lama orientabile e scorrevole
lama in acciaio cromata
base in alluminio

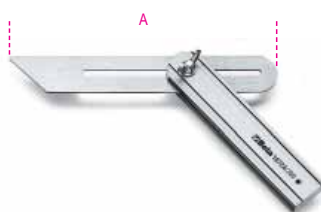

A mm	€		
200	29,00	3	016720120
300	32,00	3	016720130

1674A

squadre per falegnami
lama in acciaio, base in alluminio
doppia scala millimetrata

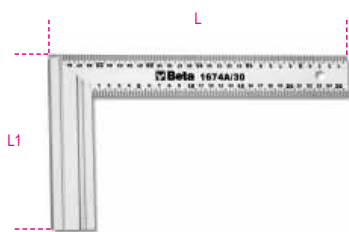

L mm	L1 mm	€		
300	169	27,50	2	016740130
400	214	34,50	2	016740140

1674C

squadre combinate per falegnami
con lama in acciaio e livella lineare
• Doppia scala millimetrata
• Livella lineare



L mm	€		
300	20,10	2	016740230

1676

goniometri semplici
in acciaio

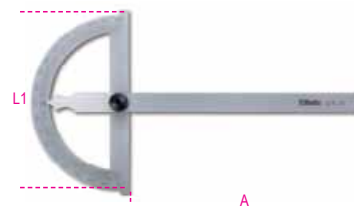

A mm	A mm	L1 mm	G mm	€		
120	120	80	1°	43,50	2	016760012
150	165	120	1°	50,00	2	016760015
200	210	150	1°	60,50	2	016760020
300	310	200	1°	81,50	1	016760030

1678/C3

rapportatore d'angoli
in acciaio inossidabile



L Max mm	D mm	€		
300	70	310,00	1	016780030

1679

calibro a tracciare con rotella
in acciaio inossidabile
lettura decimale

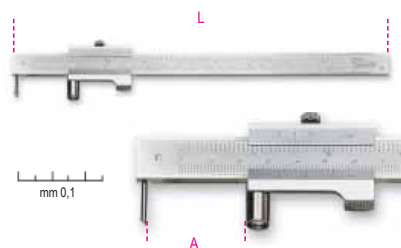

L mm	A Max mm	€		
235	200	93,50	1	016790020

1679/PR

punta di ricambio per calibro 1679



L mm	€		
1679/PR	15,10	1	016790021

1680

compasso a verga
corpo e punte di tracciatura
in acciaio temprato
• Regolazione fine cinquantessimale

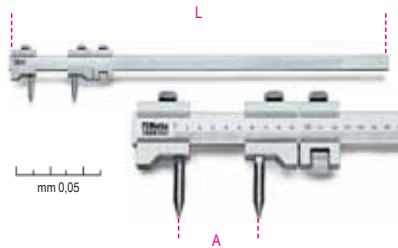

L mm	A Max mm	€	📦	📄
660	500	310,00	1	016800050

1680A

compassi di precisione per interni

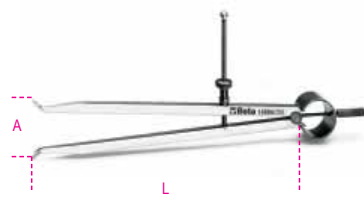

L mm	A Max mm	€	📦	📄
150	144	20,20	2	016800115
200	200	24,80	2	016800120
250	245	30,50	1	016800125
300	300	35,00	1	016800130

1680B

compassi di precisione per esterni



L mm	A Max mm	€	📦	📄
150	155	20,20	2	016800215
200	190	24,80	2	016800220
250	235	30,50	1	016800225
300	280	35,00	1	016800230

1680C

compassi di precisione per tracciatori
punte diritte in acciaio temprato



L mm	A Max mm	€	📦	📄
150	138	20,20	2	016800315
200	190	24,80	2	016800320
250	235	30,50	1	016800325
300	280	35,00	1	016800330

1682

righe flessibili graduate
in acciaio inossidabile
• doppia scala millimetrata
• antiriflesso

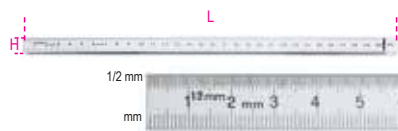

L mm	H mm	± mm	€	📦	📄
150	13	0,5	3,30	5	016820015
200	13	0,5	3,55	5	016820020
250	13	0,5	4,45	5	016820025
300	13	0,5	5,50	5	016820030
500	13	0,5	12,40	2	016820050
1000	13	0,5	32,50	2	016820100

1683

righe semirigide graduate
in acciaio inossidabile
• doppia scala millimetrata
• antiriflesso

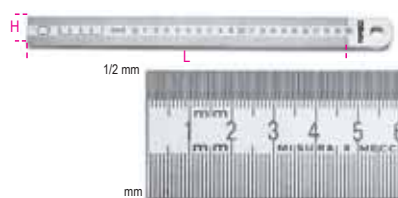

L mm	H mm	± mm	€	📦	📄
300	30	1	9,75	5	016830030
500	30	1	16,30	2	016830050
1000	30	1	41,00	2	016830100
1500	30	1	91,50	1	016830150

1685/C7

assortimento di 7 strumenti
per misurare e tracciare



1685/C7	€	📦	📄
	315,00	1	016850110

	1650	160 mm
	1658/25	0÷25 mm
	1670	100 mm
	1680C	150 mm
	1682	150 mm
	1688BC	165 mm
	1688BC/R	

📦 320x210x37 mm - 📄 1,2 kg

1687A

punta di precisione piegata a 90°
con impugnatura



1687A	L mm	L1 mm	€	📦	📄
	153	80	6,85	1	016870120

1687AC

punta di precisione piegata corta
con impugnatura



1687AC	L mm	L1 mm	€	📦	📄
	153	80	6,85	1	016870125

1687D

punta di precisione diritta
con impugnatura



1687D	L mm	L1 mm	€	📦	📄
	153	80	6,85	1	016870110

1687U

punta di precisione ad uncino
con impugnatura



1687U	L mm	L1 mm	€	📦	📄
	153	80	6,85	1	016870115

1687/S4

serie di 4 punte di precisione
con impugnatura



1687/S4	€	📦	📄
1687A-1687AC 1687D-1687U	27,50	1	016870150

1688

punta per tracciare
in acciaio temprato



	L mm	Ø mm	€		
1688	250	2	9,00	5	016880020

1688A

punta per tracciare in acciaio temprato
con punte in carburo di tungsteno



	L mm	Ø mm	€		
1688A	200	4	16,30	5	016880120

1688PC

punta per tracciare a penna
in acciaio temprato cromato



	L mm	Ø mm	€		
1688PC	150	1	38,50	1	016880300

1688PC/R

punta di ricambio per 1688PC



	€		
1688PC/R	11,30	1	016880310

1688M

matita per falegnami



	L mm	€		
1688M	180	1,18	50	016880880

1690F

metro pieghevole in fibra di vetro
classe di precisione III

CE



	L m	S mm	€		
1690F/2	2	17	13,00	5	016900220

1690L

metro pieghevole in legno di betulla
classe di precisione III

CE



	L m	S mm	€		
1690L/2	2	17	14,20	5	016900200

1691BM

flessometri
cassa bimateriale in ABS antiurto
nastro in acciaio
classe di precisione II

CE



	L m	S mm	€		
1691BM/5	5	25	17,00	1	016910205
1691BM/8	8	32	25,50	1	016910208
1691BM/10	10	32	31,00	1	016910210

1691MG

flessometri con magnete fisso
cassa bimateriale in ABS antiurto
nastro in acciaio
classe di precisione II

CE



	L m	S mm	€		
1691MG/5	5	25	15,30	1	016910405
1691MG/8	8	25	21,40	1	016910408
1691MG/10	10	25	22,60	1	016910410

1692

flessometri
cassa bimateriale in ABS antiurto
nastro in acciaio
classe di precisione II

CE



	L m	S mm	€		
1692/2	2	16	8,25	5	016920052
1692/3	3	16	10,30	5	016920053
1692/5	5	19	14,70	5	016920055
1692/8	8	25	21,20	5	016920058

1693

misuratore di distanza laser
20 metri

MISURAZIONI:

- misura di distanza singola
- misura continua o misurazione minima

Auto spegnimento

Durata batteria: fino a 4.000 misurazioni
Custodia morbida in tela (inclusa)

CE
IP54



Dati tecnici:

- Campo di misurazione: da 0,05 a 20m (da 0.2ft a 66ft)
- Selezione scala: m, in, ft
- Precisione: ±1,5 mm (± 0.06 in)
- Classe Laser: 2
- Batterie: AAA 2 x 1.5V

	H mm	L mm	S mm	€		
1693 20	100	36	23	130,50	1	016930020

1693L

misuratore di distanza laser, multifunzione
40 metri
con livelli di posizionamento

MISURAZIONI:

- misura di distanza singola
- misura continua o misurazione minima

FUNZIONI:

- Addizione/sottrazione
- misura dell'area
- misura del volume
- misurazione indiretta variabile (misurazione pitagorica)
- Misurazione inclinazione

Auto spegnimento

Durata batteria: fino a 5.000 misurazioni
Custodia morbida in tela (inclusa)

CE
IP54



Dati tecnici:

- Campo di misurazione: da 0,05 a 40m (da 0.2in a 131ft)
- Selezione scala: m, in, ft
- Precisione: ±1,5 mm (± 0.06 in)
- Classe Laser: 2
- Memorizzazione misure: 99
- Batterie: AAA 2 x 1.5V

	H mm	L mm	S mm	€		
1693L 40	115	50	25	158,50	1	016930040

1693M

misuratore di distanza laser, multifunzione
80 metri

MISURAZIONI:

- misura di distanza singola
- misura continua o misurazione minima

FUNZIONI:

- Addizione/sottrazione
- misura dell'area
- misura del volume
- misurazione indiretta variabile (misurazione pitagorica)
- Misurazione inclinazione

Auto spegnimento

Durata batteria: fino a 4.000 misurazioni

Custodia morbida in tela (inclusa)



Dati tecnici:

- Campo di misurazione: da 0,05 a 80m (da 0.2in a 229f)
- Selezione scala: m, in, ft
- Precisione: $\pm 1,5$ mm (± 0.06 in)
- Classe Laser: 2
- Memorizzazione misure: 99
- Batterie: AAA 2 x 1.5V

	H mm	L mm	S mm	€		
1693M 80	115	48	29	221,50	1	016930080

1694/L

rotelle metriche
cassa in ABS antiurto
nastro in fibra di vetro ricoperto in PVC
classe di precisione II

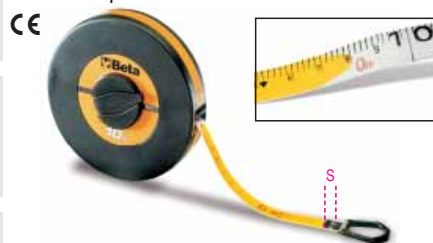

	L m	S mm	€		
1694L10	10	13	13,70	1	016940110
1694L20	20	13	17,00	1	016940120

Beta

1694A/L

rotelle metriche con impugnatura
cassa in ABS antiurto
nastro in fibra di vetro ricoperto in PVC
classe di precisione II



	L m	S mm	€		
1694A/L30	30	13	34,00	1	016940230
1694A/L50	50	13	44,50	1	016940250

1694B/L

rotella metrica con impugnatura
cassa in alluminio
nastro in acciaio smaltato
classe di precisione II



	L m	S mm	€		
1694B/L50	50	12,5	68,00	1	016940350

1695XS

livella tascabile con base a "V"
magnetica in alluminio profilato
2 file infrangibili
precisione 1mm/m

- ideale per tubi e sezioni tonde in genere
- fornita con clip



L mm	H mm	S mm	€		
70	48,5	20	13,70	5	016950250

1696

livelle in alluminio profilato anodizzato
con file infrangibili
precisione 1 mm/m



L mm	H mm	S mm	€		
200	50	19	23,00	2	016960002
400	50	19	26,50	2	016960004
500	50	19	29,00	2	016960005
600	50	19	31,00	2	016960006
800	50	19	38,50	2	016960008
1000	50	19	43,00	2	016960010

1696A

livelle in alluminio pressofuso
con 1 base rettificata a 2 file infrangibili
precisione 1 mm/m



L mm	H mm	S mm	€		
300	43	23	33,00	2	016960103
400	43	23	35,00	2	016960104
500	43	23	38,00	2	016960105
600	43	23	41,50	2	016960106
1000	43	23	83,50	1	016960110

1696B

livelle con base magnetica
in alluminio profilato
anodizzato a 2 file infrangibili
precisione 1 mm/m



L mm	H mm	S mm	€		
200	49	22	35,50	2	016960202
300	49	22	37,00	2	016960203
400	49	22	39,00	2	016960204
500	49	22	47,50	2	016960205
600	49	22	50,00	2	016960206

Beta

Beta

1696D

livelle in alluminio pressofuso con impugnature, (tranne la versione da 300 mm)
4 basi rettificate 3 file infrangibili
precisione 1 mm/m



L mm	H mm	S mm	€		
300	47	25	31,00	2	016960353
400	47	25	35,00	2	016960354
500	47	25	38,00	2	016960355
600	47	25	43,00	2	016960356

1696S

stadio in alluminio con impugnatura
a due file infrangibili
precisione 1 mm/m



L mm	H mm	S mm	€		
1500	90	25	109,50	1	016960415
2000	90	25	130,50	1	016960420
2500	90	25	162,50	1	016960425
3000	90	25	183,50	1	016960430



1697

livella laser a croce
30 metri, raggio verde
con supporto magnetico e morsetto da parete
in valigetta

CARATTERISTICHE TECNICHE:

- croce autolivellante
- possibilità di esclusione della funzione di autolivello
- diodo laser 515 Nm, classe 2
- portata: 30 mt
- precisione: ± 1 mm a 5 metri
- campo di autolivellamento: $3^\circ \pm 0.5^\circ$

- corpo in ABS e gomma antiscivolo
- attacco femmina da 1/4"
- pile 2xAAA
- autonomia: 4 ore

SUPPORTO:

- 1 supporto magnetico da usare singolarmente e in combinazione, con attacco maschio da 1/4"
- 1 supporto con morsetto con serraggio regolabile per vari profili in legno e metallo (da utilizzare in combinazione al supporto magnetico)
- possibilità di allineamento rapido orizzontale e verticale con un angolo di 90°

CE



IP55



H mm	L mm	S mm	€		
82	57	89,5	271,00	1	016970030

320x230x90 mm

1699L

livella lineare di precisione
in ghisa con base prismatica rettificata
a 2 file infrangibili
precisione 0,05 mm/m



DIN 877

	L mm	A mm	€		
1699L	200	49	328,00	1	016990002

1699L/1

livella lineare di precisione
in ghisa con base prismatica rettificata
a 2 file infrangibili
precisione 0,02 mm/m



DIN 877

	L mm	A mm	€		
1699L/1	200	49	349,00	1	016990005

16990

livelle quadre di precisione
in ghisa con 2 basi prismatiche
e 2 basi piane rettificate
a 2 file infrangibili
precisione 0,05 mm/m



DIN 877

L mm	A mm	€		
150	40	465,00	1	016990015
200	48	581,00	1	016990020

1700N

punte per edilizia



L mm	S mm	€		
250	16	17,20	5	017000005
300	16	18,60	5	017000006

1700N/PM

punte per edilizia
con paramano



L mm	S mm	€		
250	16	23,10	2	017000105
300	16	27,00	2	017000106

1701N

scapelli per edilizia



L mm	A mm	S mm	€		
250	23	16	18,50	5	017010001
300	23	16	19,90	5	017010003

1701N/PM

scapelli per edilizia
con paramano



L mm	A mm	S mm	€		
250	23	16	24,00	2	017010101
300	23	16	27,00	2	017010103

1701PMR

paramano per 1700N e 1701N



D mm	L mm	€		
16	115	11,10	1	017010206

1701NE/...

scalpelli per elettricisti



	SxL mm	€		
1701NE3	10x200	11,40	5	017010406
1701NE4	10x250	12,10	5	017010409

1702N

scalpelli a tagliante extrapiatto



A mm	SxH mm	€		
50	13x23	24,20	2	017020005
70	13x23	24,80	2	017020007

1702N/PM

scalpelli a tagliante extrapiatto con paramano



A mm	SxH mm	€		
50	13x23	29,50	2	017020105
70	13x23	32,50	2	017020107



Si raccomanda di raffreddare frequentemente l'utensile durante la riaffilatura.

1702PMR

paramano per 1702N



L mm	€		
115	8,60	1	017020200

1704

leve piegate per carpentieri con estremità temprate

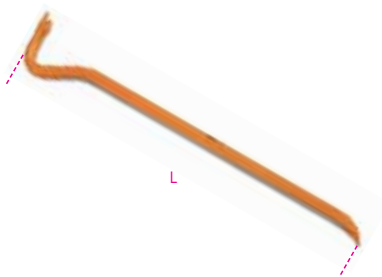

L mm	6 mm	M mm	I mm	€		
500	16	35	28	31,00	2	017040050
600	16	34	26	35,00	2	017040060
800	18	38	29	49,00	2	017040080

1704A

leve con estremità temprate, a punta e a scalpello

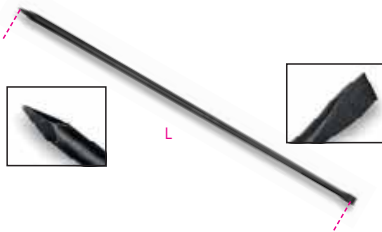

L mm	Ø mm	I mm	€		
1500	25	45	105,00	1	017040110
2000	25	55	123,50	1	017040120

1704C

leve con estremità a punta e penna chiusa



L mm	8 min-MAX mm	I mm	€		
1200	21-31	39	106,00	1	017040210
1400	31-37	42	127,00	1	017040212
1600	25-37	42	157,50	1	017040215

1705

traccialinea in alluminio



L m	€		
1705	30	20,80	4 017050001

1705PT

polvere traccialinea

- contenitore con dispositivo di versamento.
- colore blu



g	€		
250	13,40	5	017050025

1706DGT

calibro digitale di profondità per battistrada pneumatici



1706DGT	€		
	39,00	1	017060011

1707

contafiletto

Per filetti metrici ISO a 60° e Whitworth a 55°



P (ISO)	W	€		
0,25÷6	62÷4x1"	18,40	5	017070001

1707A/1 - 2 - 3

raggimetri

lame concave e convesse, in acciaio

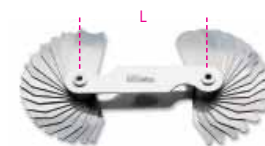

	R mm	L mm	n	€		
1707A/1	1,0÷7,0	70	34	28,00	2	017070007
1707A/2	7,5÷15	85	32	30,50	2	017070015
1707A/3	15,5÷25	85	30	30,50	2	017070025

1708/8 - 13 - 20

spessimetri



	€		
1708/8 S = 0,05±0,50 mm	7,00	5	017080008
1708/13 S = 0,05±1,00 mm	7,90	5	017080013
1708/20 S = 0,05±1,00 mm	12,80	5	017080020

1709/10 - 1709/18

spaccadadi



	L mm	A max mm	€	
1709/10	82,5	17 (M10)	56,50	1 017090010
1709/18	107,8	24 (M16)	62,50	1 017090018

1710

spaccadadi idraulico



	C min mm	C max mm	€	
1710	7 (M4)	22 (M14)	260,00	1 017100001

1712E/1 - 2 - 3

flessibili magnetici

F = forza magnetica



	L mm	D mm	F kg	€	
1712E/1	420	7,5	0,5	33,50	2 017120011
1712E/2	530	15	1,8	42,50	2 017120012
1712E/3	532	19	3,0	52,50	2 017120013

1712TF

magnete telescopico con testa flessibile

• Con pulitore per ugelli lavavetri
F= forza magnetica



	L mm	D mm	F kg	€	
1712TF	150±590	11	1	22,20	1 017120600

1713M

artigli prensili flessibili

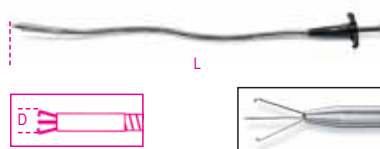

	L mm	D mm	€	
1713M	500	7	46,50	2 017130011
	1000	7	82,00	1 017130015

1713M/K7

kit 7 utensili per ispezione con componenti ad attacco esagonale 1/4"

Inclusi nel kit:

- 1 impugnatura telescopica, lunghezza 185-660 mm
- 1 specchio rettangolare, 65x43 mm
- 1 specchio rotondo, Ø 52 mm
- 1 magnete, diametro Ø 16,3 mm
- 1 luce LED ultra chiara
- 1 artiglio prensile flessibile (N.Art 1713M)
- 1 vassoio portaminuterie magnetico in acciaio inossidabile
- 3 batterie a celle LR44



	€	
1713M/K7	165,00	1 017130100

297x165x52 mm - 0,8 kg

1714

specchietto rigido in materiale plastico



	L mm	D mm	€	
1714	155	25	4,10	5 017140001

1715

specchietto telescopico articolato corpo in metallo cromato



	L mm	D mm	€	
1715	180±540	30	35,00	1 017150001

1715FL/A

specchietto flessibile rettangolare

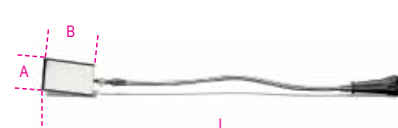

	L mm	A mm	B mm	€	
1715FL/A	600	53	90	42,00	1 017150110

1715R/FL

kit di 2 specchietti di ricambio per 1715FL/A e 1715FL/B

	€	
1715R/FL	8,85	1 017150151

1715FL/B

specchietto flessibile rettangolare con illuminazione
pile: 2X AA

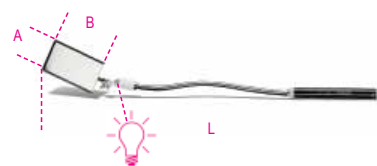

	L mm	A mm	B mm	€	
1715FL/B	553	53	90	50,00	1 017150115

1715B/R5L

kit di 5 lampadine di ricambio per 1715FL/B

	€	
1715B/R5L	7,20	1 017150152

1715I

specchietto telescopico articolato con funzione di ingrandimento 5x

- Impugnatura in PVC antiscivolo
- Specchietto e manico in acciaio inossidabile



	L mm	D mm	€	
1715I	250±720	55	32,50	1 017150020

1715L

specchietto telescopico articolato con luce LED

- Corpo in acciaio inossidabile
- Tascabile con clip
- Fornito con 3 batterie tipo L736F



	L mm	D mm	€	
1715L	265±765 mm	50	51,00	1 017150005

1716A

punta angolata per usi generici



	L mm	L1 mm	€	
1716A	240	125	12,00	3 017160040

1716P

raschietto per guarnizioni



L	L1	Ø	€	Q	Art.
mm	mm	mm			
250	125	6	14,70	3	017160020

1716R

punteruolo a punta tonda



L	L1	Ø	€	Q	Art.
mm	mm	mm			
215	100	6	10,30	5	017160001

1716U

punta ad uncino per usi generici



L	L1	Ø	€	Q	Art.
mm	mm	mm			
195	80	6	12,00	3	017160025

1717A

raschietti a due taglianti



L	L1	L2	€	Q	Art.
mm	mm	mm			
150	70	260	22,60	2	017170015
200	75	310	24,20	2	017170020
250	100	360	27,00	2	017170025

1717B

raschietti a tre taglianti



L	L1	L2	€	Q	Art.
mm	mm	mm			
150	75	260	19,60	2	017170115
200	85	310	22,80	2	017170120
250	100	360	25,50	2	017170125

1717C

raschietti piatti



L	S	L1	€	Q	Art.
mm	mm	mm			
150	18	270	19,40	2	017170215
200	20	320	21,70	2	017170220
250	25	370	24,30	2	017170225

1717D

raschietto piatto a tagliente frontale



L	S	L1	€	Q	Art.
mm	mm	mm			
150	23	240	26,50	2	017170320

1717T

raschietti con lama triangolare completa di 2 lame



L	€	Q	Art.
mm			
310	12,40	1	017170610

1717T RT

lame triangolari di ricambio



L	€	Q	Art.
mm			
65	2,56	1	017170660

1717T RS

lame sagomate di ricambio



€	Q	Art.
2,56	1	017170661

1717V

raschietti per vernici con lama utilizzabile su più lati



L	A	€	Q	Art.
mm	mm			
200	38	8,30	1	017170703
285	65	17,80	1	017170706

1717V R

lame di ricambio per 1717V



L	€	Q	Art.
mm			
38	2,56	1	017170753
65	3,65	1	017170756

I TAGLI DELLE LIME PER MECCANICA

Grossolano

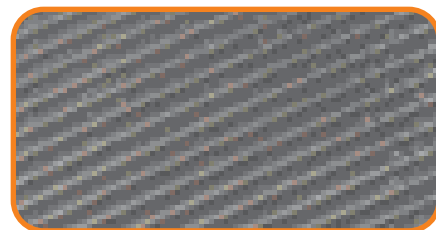

Mezzodolce

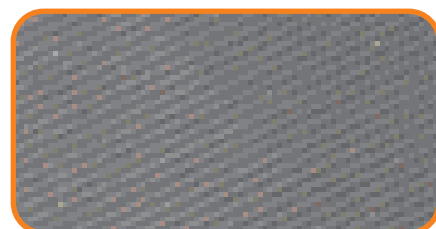

Dolce

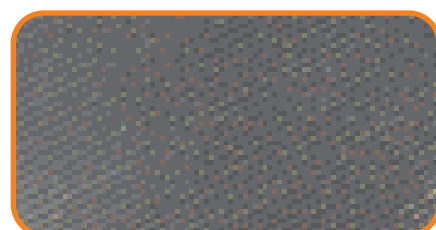

1718D...Q

lime quadre a taglio **grossolano**, senza impugnatura



L	L"	€	Q	Art.
mm	"			
150	6	9,75	5	017180121
200	8	11,60	5	017180131
250	10	15,80	5	017180141

1718A...Q

lime quadre a taglio **mezzodolce**, senza impugnatura



L	L"	€	Q	Art.
mm	"			
150	6	9,95	5	017180021
200	8	12,00	5	017180031
250	10	16,50	5	017180041

1718D...T

lime triangolari a taglio **grossolano**, senza impugnatura



	L mm	L "	€		
1718D6/T	150	6	11,70	5	017180123
1718D8/T	200	8	14,90	5	017180133
1718D10/T	250	10	19,70	5	017180143

1718A...T

lime triangolari a taglio **mezzodolce**, senza impugnatura



	L mm	L "	€		
1718A6/T	150	6	12,00	5	017180023
1718A8/T	200	8	15,30	5	017180033
1718A10/T	250	10	20,60	5	017180043

1718D...P

lime piatte a taglio **grossolano**, senza impugnatura



	L mm	L "	€		
1718D6/P	150	6	9,20	5	017180125
1718D8/P	200	8	10,80	5	017180135
1718D10/P	250	10	14,50	5	017180145

1718A...P

lime piatte a taglio **mezzodolce**, senza impugnatura



	L mm	L "	€		
1718A6/P	150	6	9,75	5	017180025
1718A8/P	200	8	11,20	5	017180035
1718A10/P	250	10	15,80	5	017180045

1718D...M

lime mezzotonde a taglio **grossolano**, senza impugnatura



	L mm	L "	€		
1718D6/M	150	6	12,90	5	017180127
1718D8/M	200	8	15,90	5	017180137
1718D10/M	250	10	20,60	5	017180147

1718A...M

lime mezzotonde a taglio **mezzodolce**, senza impugnatura



	L mm	L "	€		
1718A6/M	150	6	13,10	5	017180027
1718A8/M	200	8	16,30	5	017180037
1718A10/M	250	10	21,70	5	017180047

1718D...R

lime tonde a taglio **grossolano**, senza impugnatura



	L mm	L "	€		
1718D6/R	150	6	9,20	5	017180129
1718D8/R	200	8	10,80	5	017180139
1718D10/R	250	10	14,20	5	017180149

1718A...R

lime tonde a taglio **mezzodolce**, senza impugnatura



	L mm	L "	€		
1718A6/R	150	6	9,75	5	017180029
1718A8/R	200	8	11,20	5	017180039
1718A10/R	250	10	15,00	5	017180049

1718D...S5

serie di 5 lime a taglio **grossolano**, senza impugnatura



	L mm	L "	€		
1718D6/S5	150	6	52,50	1	017180130
1718D8/S5	200	8	64,00	1	017180140
1718D10/S5	250	10	85,00	1	017180150

1718A...S5

serie di 5 lime a taglio **mezzodolce**, senza impugnatura



	L mm	L "	€		
1718A6/S5	150	6	54,50	1	017180030
1718A8/S5	200	8	66,00	1	017180040
1718A10/S5	250	10	89,50	1	017180050

1719BMD...Q

lime quadre a taglio **grossolano**, con impugnatura



	L mm	L "	€		
1719BMD6/Q	150	6	13,30	5	017190191
1719BMD8/Q	200	8	14,70	5	017190221
1719BMD10/Q	250	10	20,20	5	017190241
1719BMD12/Q	300	12	26,50	3	017190325

1719BMA...Q

lime quadre a taglio **mezzodolce**, con impugnatura



	L mm	L "	€		
1719BMA6/Q	150	6	13,40	5	017190021
1719BMA8/Q	200	8	16,10	5	017190052
1719BMA10/Q	250	10	21,00	5	017190071
1719BMA12/Q	300	12	31,00	3	017190311

1719BMX...Q

lime quadre a taglio **dolce**, con impugnatura



	L mm	L "	€		
1719BMX6/Q	150	6	14,30	5	017190022
1719BMX8/Q	200	8	18,50	5	017190053
1719BMX10/Q	250	10	25,00	5	017190072

1719BMD...T

lime triangolari a taglio **grossolano**, con impugnatura



	L mm	L "	€		
1719BMD6/T	150	6	15,90	5	017190193
1719BMD8/T	200	8	18,20	5	017190223
1719BMD10/T	250	10	24,50	5	017190243
1719BMD12/T	300	12	35,00	3	017190326

1719BMA...T

lime triangolari a taglio **mezzodolce**, con impugnatura



	L mm	L "	€		
1719BMA6/T	150	6	15,90	5	017190023
1719BMA8/T	200	8	19,70	5	017190054
1719BMA10/T	250	10	25,50	5	017190073
1719BMA12/T	300	12	36,50	3	017190313

1719BMX...T

lime triangolari a taglio **dolce**, con impugnatura



	L mm	L "	€		
1719BMX6/T	150	6	18,80	5	017190024
1719BMX8/T	200	8	24,50	5	017190055
1719BMX10/T	250	10	31,50	5	017190074

1719BMD...P

lime piatte a taglio **grossolano**, con impugnatura



	L mm	L "	€	Impugnatura	Impugnatura
1719BMD6/P	150	6	13,30	5	017190195
1719BMD8/P	200	8	14,00	5	017190225
1719BMD10/P	250	10	19,80	5	017190245
1719BMD12/P	300	12	26,00	3	017190327

1719BMA...P

lime piatte a taglio **mezzodolce**, con impugnatura



	L mm	L "	€	Impugnatura	Impugnatura
1719BMA6/P	150	6	14,00	5	017190025
1719BMA8/P	200	8	15,90	5	017190056
1719BMA10/P	250	10	20,50	5	017190075
1719BMA12/P	300	12	29,50	3	017190315

1719BMX...P

lime piatte a taglio **dolce**, con impugnatura



	L mm	L "	€	Impugnatura	Impugnatura
1719BMX6/P	150	6	14,30	5	017190026
1719BMX8/P	200	8	18,80	5	017190057
1719BMX10/P	250	10	24,50	5	017190076

1719BMD...M

lime mezzotonde a taglio **grossolano**, con impugnatura



	L mm	L "	€	Impugnatura	Impugnatura
1719BMD6/M	150	6	17,50	5	017190197
1719BMD8/M	200	8	18,80	5	017190227
1719BMD10/M	250	10	25,50	5	017190247
1719BMD12/M	300	12	35,50	3	017190328

1719BMA...M

lime mezzotonde a taglio **mezzodolce**, con impugnatura



	L mm	L "	€	Impugnatura	Impugnatura
1719BMA6/M	150	6	18,20	5	017190027
1719BMA8/M	200	8	21,30	5	017190058
1719BMA10/M	250	10	27,50	5	017190077
1719BMA12/M	300	12	39,00	3	017190317

1719BMX...M

lime mezzotonde a taglio **dolce**, con impugnatura



	L mm	L "	€	Impugnatura	Impugnatura
1719BMX6/M	150	6	19,40	5	017190028
1719BMX8/M	200	8	23,90	5	017190059
1719BMX10/M	250	10	33,50	5	017190078

1719BMD...R

lime tonde a taglio **grossolano**, con impugnatura



	L mm	L "	€	Impugnatura	Impugnatura
1719BMD6/R	150	6	13,30	5	017190199
1719BMD8/R	200	8	13,80	5	017190229
1719BMD10/R	250	10	19,30	5	017190249
1719BMD12/R	300	12	25,50	3	017190329

1719BMA...R

lime tonde a taglio **mezzodolce**, con impugnatura



	L mm	L "	€	Impugnatura	Impugnatura
1719BMA6/R	150	6	14,10	5	017190029
1719BMA8/R	200	8	15,70	5	017190060
1719BMA10/R	250	10	20,00	5	017190079
1719BMA12/R	300	12	27,00	3	017190319

1719BMX...R

lime tonde a taglio **dolce**, con impugnatura



	L mm	L "	€	Impugnatura	Impugnatura
1719BMX6/R	150	6	16,30	5	017190031
1719BMX8/R	200	8	18,20	5	017190061
1719BMX10/R	250	10	24,50	5	017190081

1719BMA...B5

serie di 5 lime a taglio **mezzodolce**, con impugnatura in busta appendibile



	L mm	L "	€	Impugnatura	Impugnatura
1719BMA8/B5	200	8	88,50	1	017190297
1719BMA10/B5	250	10	114,50	1	017190298

1719BMD...B5

serie di 5 lime a taglio **grossolano**, con impugnatura in busta appendibile



	L mm	L "	€	Impugnatura	Impugnatura
1719BMD8/B5	200	8	79,50	1	017190303
1719BMD10/B5	250	10	109,50	1	017190305

1719BMD...S5

serie di 5 lime a taglio **grossolano**, con impugnatura

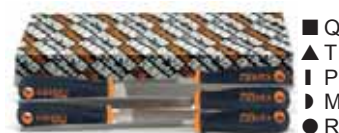

	L mm	L "	€	Impugnatura	Impugnatura
1719BMD6/S5	150	6	73,50	1	017190200
1719BMD8/S5	200	8	79,50	1	017190230
1719BMD10/S5	250	10	109,50	1	017190250
1719BMD12/S5	300	12	148,50	1	017190363

1719BMA...S5

serie di 5 lime a taglio **mezzodolce**, con impugnatura



	L mm	L "	€	Impugnatura	Impugnatura
1719BMA6/S5	150	6	75,50	1	017190030
1719BMA8/S5	200	8	88,50	1	017190070
1719BMA10/S5	250	10	114,50	1	017190080
1719BMA12/S5	300	12	163,00	1	017190361

1719BMX...S5

serie di 5 lime a taglio **dolce**, con impugnatura



	L mm	L "	€	Impugnatura	Impugnatura
1719BMX6/S5	150	6	83,00	1	017190032
1719BMX8/S5	200	8	104,00	1	017190069
1719BMX10/S5	250	10	139,00	1	017190082

1719BMB/P

lime piatte a taglio universale
impugnatura in materiale plastico



L mm	L "	€		
250	10	31,50	5	017190152
300	12	37,00	5	017190153

1719BMC

lime mezzotonde e piatte a mazzo
impugnatura in materiale plastico



UNI 5569 - UNI 5568

	L mm	L "	€		
1719BMC/M 250	250	10	21,00	6	017190252
1719BMC/M 300	300	12	26,50	4	017190253
1719BMC/P 250	250	10	16,60	6	017190262
1719BMC/P 300	300	12	20,50	4	017190263

1719BM/RL

raspa/lima piatta
1 lato raspa a taglio mezzodolce,
1 lato lima a taglio grossolano
impugnatura in materiale plastico



	L mm	L "	€		
1719BM/RL	200	8	16,60	5	017190360

1719BM/RR

raspa tonda
impugnatura in materiale plastico



	L mm	L "	€		
1719BM/RR	200	8	17,40	5	017190351

1719BM/RG

raspa mezzotonda a gabinetto
impugnatura in materiale plastico



	L mm	L "	€		
1719BM/RG	200	8	17,20	5	017190353

1719BM/RP

raspa piatta
impugnatura in materiale plastico



	L mm	L "	€		
1719BM/RP	200	8	17,70	5	017190352

1719BMR/B3

serie di 3 raspe a taglio mezzodolce,
con impugnatura
in busta appendibile



	L mm	L "	€		
1719BMR/B3	200	8	52,50	1	017190358

1719BMR

impugnature per lime



	L mm	A mm	€		
1719BMR/0	95	25	3,80	10	017190950
1719BMR/OB	110	29	3,80	10	017190955
1719BMR/1	110	29	3,80	10	017190951
1719BMR/1B	110	29	3,80	10	017190953
1719BMR/2	123	31	3,80	10	017190952
1719BMR/2B	123	31	3,80	10	017190954

	mm	"		
1719BMR/0	100/150	4/6	▲▲	▶▶
1719BMR/OB	100/150	6/8	●●	▶▶
1719BMR/1	150/200	6/8	▲▲	▶▶
1719BMR/1B	150/200	6/8	●●	▶▶
1719BMR/2	250/300	10/12	▲▲	▶▶
1719BMR/2B	250/300	10/12	●●	▶▶



1720/...

lime ad ago
taglio mezzodolce
gambo Ø 3 mm

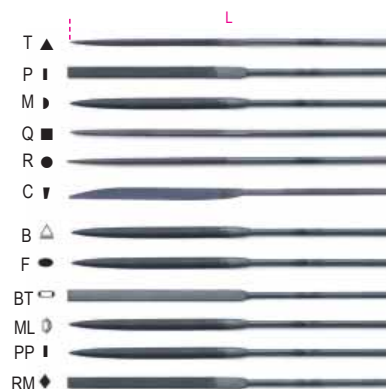

UNI 5569 UNI 5670

	L mm	€		
1720T	160	7,65	5	017200004
1720P	160	7,65	5	017200006
1720M	160	7,65	5	017200008
1720Q	160	7,65	5	017200009
1720R	160	7,65	5	017200010
1720C	160	7,65	5	017200012
1720B	160	7,65	5	017200005
1720ML	160	7,65	5	017200007
1720BT	160	7,65	5	017200011
1720F	160	7,65	5	017200013
1720PP	160	7,65	5	017200014
1720RM	160	7,65	5	017200015



	€		
1720/S3	23,00	1	017200000

1720/B



	€		
1720/B6	48,00	1	017200002
1720/B12	92,00	1	017200003

1720D/...

lime ad ago diamantate
grana D126



	L mm	€		
1720D/T	160	49,50	2	017200104
1720D/P	160	49,50	2	017200106
1720D/M	160	49,50	2	017200108
1720D/Q	160	49,50	2	017200109
1720D/R	160	49,50	2	017200110
1720D/C	160	49,50	2	017200112



1720D/B6 € 299,00 1 017200120

1721/B6

serie di 6 lime per contatti
in busta di plastica



1721/B6 € 25,50 1 017210010

1723

tenditore per molle



1723 L mm 210 € 16,60 5 017230001

1725

seghetto



1725 L mm 420 L1 mm 300 € 22,90 4 017250001

1725CR

miniseghetto

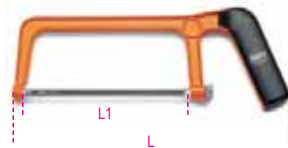

1725CR L mm 250 L1 mm 150 € 12,50 5 017250010

1726

seghetto
con sistema di tensionamento della lama
incorporato nell'impugnatura

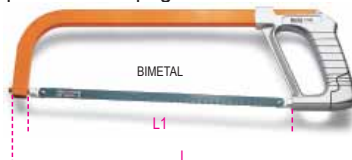

1726 L mm 440 L1 mm 300 € 30,50 4 017260001

1726BM

seghetto con sistema di tensionamento
della lama a sgancio rapido

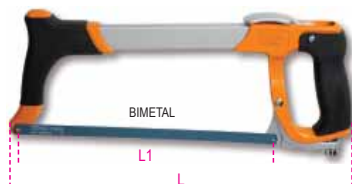

1726BM L mm 400 L1 mm 300 € 49,00 1 017260050

1727

seghetto tipo pesante

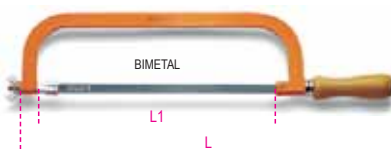

1727 L mm 515 L1 mm 300 € 21,00 4 017270001

1727BM

seghetto
portalama



1727BM L mm 315 L1 mm 300 € 25,50 5 017270020

1728...

lame per segchetti

1728LA



1728BM
(HSS-BIMETAL)

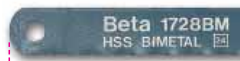

24x1"

1728CO
(HSS-BIMETAL
COBALT)



1728LA € 1,49 100 017280001

1725CR € 3,75 100 017280010

1725MQ € 5,20 50 017280030

1728BM € 3,75 100 017280010

1725-1726 € 5,20 50 017280030

1727-1727M € 5,20 50 017280030

1728CO € 5,20 50 017280030

1725-1726 € 5,20 50 017280030

1727-1727M € 5,20 50 017280030

1729CG

seghetto per cartongesso



1729CG L mm 310 L1 mm 160 € 25,00 2 017290200

1729DM 450

segaccio per legno

dentatura media, 12 denti per pollice



1729DM 450 L mm 450 L1 mm 400 € 28,50 4 017290450

1730

spatole universali con lama INOX e
impugnatura



S mm	L mm	L1 mm	€		
38	210	85	6,35	2	017300038
63	220	95	7,55	2	017300063
75	220	95	8,20	2	017300075
100	220	95	9,45	2	017300100

1730M

spatole per miscelatori
con lama INOX e impugnatura



L1 mm	L mm	S mm	€		
150	245	27	8,85	2	017300215
200	330	28	16,50	2	017300220
250	365	36	20,40	2	017300225

1730V 38

spatola per vetrai
lama a coltello in INOX



1730V 38 S mm 38 L mm 225 L1 mm 100 € 6,35 2 017300338

1736A

spazzola per lime
filo in acciaio INOX
Ø filo 0,5 mm



1736A L mm 240 € 11,50 10 017360010

1737

spazzolino con fili di ottone ondulato
Ø filo 0,2 mm



1737 L mm 145 € 5,60 10 017370001

1737NX

spazzola curva a fili di acciaio ottonato
Ø filo 0,3 mm



1737NX L mm 270 € 6,70 5 017370010

1737AC

spazzola a fili di acciaio
a 5 ranghi
Ø filo 0,3 mm



1737AC L mm 275 € 6,40 5 017370020

1737B

coppie di spazzole
per pulizia morsetti e
poli batteria veicoli
filo in acciaio
Ø filo 0,3 mm



1737B € 15,70 1 017370050

1738

pennello



1738 L mm 210 H mm 30 € 9,15 10 017380001

1739C

rivettatrice estensibile
fornita con 5 testine intercambiabili



Ø mm	3,2	4	4,8	5	6	6,4
Alluminio	•	•	•	•	•	•
Inox	•	•	•	•	•	•

1739C L max mm 810 € 133,50 1 017390152

1740AN

rivettatrice di potenza
fornita con 5 testine intercambiabili
• Completa di serbatoio raccogli rivetti



Ø mm	3,2	4	4,8	5	6	6,4
Alluminio	•	•	•	•	•	•
Inox	•	•	•	•	•	•

1740AN L mm 530 € 121,50 1 017400103

1740B

rivettatrice di potenza compatta
con serbatoio porta-steli
fornita con 5 testine intercambiabili

Rapporto di leva ottimizzato per una maggiore compattezza e praticità d'uso.

Caratteristiche:

- Ultracompatta e resistente
- 3 griffe per una migliore presa del rivetto
- Testa regolabile per tirare il rivetto da 2 a 5 movimenti dei bracci
- Dotata di serbatoio porta-steli con 5 testine intercambiabili



Ø mm	2,4	3	3,2	4	4,8
Alluminio	•	•	•	•	•
Acciaio	•	•	•	•	•
Inox	•	•	•	•	•

1740B 280 L mm 280 € 78,50 1 017400280

Ø mm	2,4	3,2	4,0	4,8	6,4
Alluminio	•	•	•	•	•
Acciaio	•	•	•	•	•
Inox	•	•	•	•	•

1740B 330 L mm 330 € 91,00 1 017400330

1741B

rivettatrice
fornita con 4 testine intercambiabili



Ø mm	2,4	3,2	4	4,8	5
Alluminio	•	•	•	•	•
Acciaio	•	•	•	•	•
Inox	•	•	•	•	•

1741B € 41,50 1 017410000

1741B/C5

rivettatrice 1741B con assortimento
di 700 rivetti in alluminio



1741B/C5 € 128,50 1 017410025

	Ø mm	L mm	n.
1741RV2,9K	3,0	6	200
1741RV3,2K	3,2	8	200
1741RV3,8K	4,0	10	100
1741RV4K	4,0	12	100
1741RV4,8K	4,8	12	100

415x155x60 mm - 3,1 Kg



1741BP

rivettatrice
fornita con 4 testine intercambiabili



260 mm

Ø mm	2,4	3,2	4	4,8	5
Alluminio	•	•	•	•	•
Acciaio	•	•	•	•	•
Inox	•	•	•	•	•

1741BP € 63,50 1 017410350

1741U

rivettatrice ultra compatta con regolazione dello sforzo
fornita con 4 testine intercambiabili



200 mm

Ø mm	2,4	3	3,2	4	4,8
Alluminio	•	•	•	•	•
Acciaio	•	•	•	•	•
Inox	•	•	•	•	•

1741U € 49,00 1 017410450

1741RV...K

rivetti in alluminio

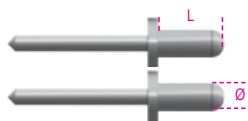

1741RV 2,9K ØxL = 3x6 mm	€ 20,80	1 017410191
1741RV 3,2K ØxL = 3,2x8 mm	€ 21,50	1 017410192
1741RV 3,8K ØxL = 4x10 mm	€ 27,00	1 017410193
1741RV 4K ØxL = 4x12 mm	€ 29,50	1 017410194
1741RV 4,8K ØxL = 4,8x12 mm	€ 36,50	1 017410195

I prezzi indicati sono relativi a 500 pezzi

1742N

rivettatrice per inserti filettati
fornita con 4 testine intercambiabili
e 4 perni (1x M3;M4;M5;M6)



250 mm

1742N € 137,50 1 017420002

	Ø mm	L mm
3	5	11
4	6	11
5	7	13
6	9	17

1742N/KR

kit di 4 perni di ricambio per 1742N



M3	€ 59,00	1 017420063
M4	€ 59,00	1 017420064
M5	€ 59,00	1 017420065
M6	€ 59,00	1 017420066

1742R-AL/M...

rivetti in alluminio filettati per 1742N-1742AN-1946KF

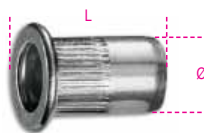

1742R-AL M3 ØxL = 5x10 mm M = 3	€ 5,15	1 017420023
1742R-AL M4 ØxL = 6x12 mm M = 4	€ 5,25	1 017420024
1742R-AL M5 ØxL = 7x13 mm M = 5	€ 5,65	1 017420025
1742R-AL M6 ØxL = 9x15 mm M = 6	€ 6,85	1 017420026

I prezzi indicati sono relativi a 20 pezzi

1742R-A/M...

rivetti in acciaio filettati per 1742N-1742AN-1946KF



1742R-A M3 ØxL = 5x11 mm M = 3	€ 5,45	1 017420013
1742R-A M4 ØxL = 6x11 mm M = 4	€ 5,55	1 017420014
1742R-A M5 ØxL = 7x13 mm M = 5	€ 5,85	1 017420015
1742R-A M6 ØxL = 9x17 mm M = 6	€ 7,00	1 017420016
• 1742R-A M8 ØxL = 11x17 mm M = 8	€ 6,65	1 017420018
• 1742R-A M10 ØxL = 13x24 mm M = 10	€ 7,95	1 017420020
• 1742R-A M12 ØxL = 12x24 mm M = 12	€ 8,95	1 017420022

I prezzi indicati sono relativi a 20 pezzi
I prezzi indicati sono relativi a 10 pezzi

1742N/C4

rivettatrice 1742N con assortimento di 400 inserti filettati in acciaio



1742N/C4 € 308,00 1 017420006

	M	Ø mm	n.
1742R-A/M3	3	5	100
1742R-A/M4	4	6	100
1742R-A/M5	5	7	100
1742R-A/M6	6	9	100

415x155x60 mm - 2,9 kg

1742AN

rivettatrice di potenza per inserti filettati fornita con 7 testine intercambiabili



533mm

1742AN € 435,00 1 017420101

	Ø mm	L mm
M 5	7	13
M 6	9	17
M 8	11	17
M 10	13	24

1742AN/KR

kit di 4 perni di ricambio per 1742AN



		€		
1742AN/KR M3	M3	40,00	1	017420153
1742AN/KR M4	M4	40,00	1	017420154
1742AN/KR M5	M5	40,00	1	017420155
1742AN/KR M6	M6	40,00	1	017420156
1742AN/KR M8	M8	40,00	1	017420158
1742AN/KR M10	M10	40,00	1	017420160
1742AN/KR M12	M12	40,00	1	017420162

1742AN/C

rivettatrice 1742AN con assortimento di 80 inserti filettati in acciaio



1742AN/C		506,00	1	017420106
----------	--	--------	---	-----------

	M	∅ mm	n.
1742R-A/M5	5	7	20
1742R-A/M6	6	9	20
1742R-A/M8	8	11	10
1742R-A/M10	10	13	10

420x240x80 mm - 2,5 kg

1749

pistola per sigillante



	L min mm	€		
1749	340	14,70	2	017490001

1749A

pistola per sigillante modello professionale tubo in alluminio.

Capacità cartucce 310ml
Capacità sacchetti 310ml

Non idonea per utilizzo con sigillante sfuso.



	L min mm	€		
1749A	360	46,00	1	017490010

1749A/RB

beccucci di ricambio per 1749A

1749A/RB		1,06	1	017490051
----------	--	------	---	-----------

1749A/RT

tappi frontali avvitabili per 1749A

1749A/RT		2,33	1	017490052
----------	--	------	---	-----------

1749AC

pistola ad alta spinta per ancoranti chimici e cartucce standard



	L min mm	€		
1749AC	360	41,00	1	017490005

1750

compressori a leva per grasso

utilizzabile con cartucce 1750CG oppure con grasso sfuso



1 g, 550 bar Max

1750CG cc	cc	L mm	€		
400	500	380	45,50	1	017500500
600	750	450	53,50	1	017500750

1750R/1 - 1750R/2

tubi flessibili di ricambio in Nylon



	L mm	€		
1750R/1	310	7,20	2	017500030
1750R/2	410	8,00	2	017500040

1750RC

tubo rigido piegato



	L mm	M mm	€		
1750RC	150	10x1	5,90	2	017500050

1750RT

testina a 4 griffe tipo "Hydraulic"



	M mm	€		
1750RT	10x1	5,30	5	017500110

1750RP/1 - 1750RP/2

testine per raccordi piatti



	∅ mm	M mm	€		
1750RP/1	16	10x1	13,10	2	017500115
1750RP/2	22	10x1	29,50	2	017500120

1750CG

cartucce di grasso universale per 1750

• Temperatura di impiego da -20°C a +130°C



cc	€		
400	16,00	18	017500140
600	20,00	18	017500160

1750KG10

ingrassatore a leva da 10 kg,
con tubo ad alta pressione da 2 m

dotato di raccordo girevole per non strozzare il tubo.
corpo pompante in alluminio pressofuso con valvola di sfiatione

3 differenti livelli di pressione impostabili:

- 4 gr a 275 bar
- 7 gr a 206 bar
- 9 gr a 137 bar



1750KG10 € 204,50 1 017500100

1750TA

testina per ingrassaggio autobloccante a 6
spilli

- una volta posizionata rimane in asse e collegata al nipplo
- agevole disconnessione anche con testina in pressione.
- filetto M10x1: adatto a tutti i tipi di ingrassatore: elettrico, pneumatico, manuale, ecc.
- nessuna deformazione fino a 550 bar



1750TA € 48,00 1 017500111

1750TLA

testina per ingrassaggio autobloccante a 6
spilli, versione lunga

- una volta posizionata rimane in asse e collegata al nipplo
- agevole disconnessione anche con testina in pressione.
- filetto M10x1: adatto a tutti i tipi di ingrassatore: elettrico, pneumatico, manuale, ecc.
- nessuna deformazione fino a 550 bar



1750TLA € 64,50 1 017500112

1750M

mini ingrassatore

- Con microugello
- Particolarmente indicato per utensili pneumatici



1750M	cc	D mm	L mm	€	Icon	Icon
1750M	100	43	145	23,90	1	017500025

1750M3

mini ingrassatore a 3 ugelli

- Dotato di tre ugelli intercambiabili: 0.7 - 1.0 - 1.4 mm
- Particolarmente indicato per la lubrificazione di utensili pneumatici
- Utilizzabile con grasso sfuso
- Adatta per l'utilizzo di grasso di grado fino a NLGI 2



1750M3	cc	Ø mm	L mm	€	Icon	Icon
1750M3	85	42	160	31,50	1	017500003

1751CR

oliatori metallici a pressione
cannuccia rigida



cc	D mm	L mm	€	Icon	Icon
200	62	140	16,20	4	017510202
300	75	140	17,50	4	017510203
500	85	140	18,60	4	017510205
700	100	140	20,30	2	017510207
1000	100	140	22,10	2	017510210

1751N

oliatori metallici a pressione
cannuccia flessibile



cc	D mm	L mm	€	Icon	Icon
200	62	140	17,10	4	017510020
300	75	140	18,60	4	017510030
500	85	140	19,50	4	017510050
700	100	140	21,20	2	017510075
1000	100	140	23,10	2	017510100

1752

oliatori in plastica a pressione
cannuccia rigida



cc	D mm	L mm	€	Icon	Icon
200	67	140	11,10	4	017520002
300	77	140	12,00	4	017520003
500	95	140	12,60	4	017520005

1754

oliatori in plastica a pressione
cannuccia flessibile



cc	D mm	L mm	€	Icon	Icon
150	60	130	10,10	5	017540015
250	65	130	11,40	5	017540025

1755C

oliatori in plastica
cannuccia curva



cc	L mm	A mm	€		
125	110	46	4,60	5	017550112
250	110	60	6,30	5	017550125
500	110	74	7,15	4	017550150

1756

oliatore a stilo

idoneo per l'utilizzo con oli minerali



cc	L mm	€		
5	140	24,20	2	017560001

1756B

siringa per olio

- con zigrinatura antiscivolo
- Temperatura di funzionamento: -10°C - +60°C
- Densità minima olio SAE 10



cc	L mm	€		
500	280	23,50	2	017560220

1756C

siringa per olio da 200 ml
in polipropilene

- Adatta anche al liquido impianto freni
- Doppia guarnizione in EPDM
- Temperatura di funzionamento: +0 - +50°C
- Non adatta per carburanti e oli minerali
- Densità minima utilizzabile di olio è ISO 150, SAE 90 (olio cambio), SAE 40 (olio motore)



1756C	€		
	36,50	1	017560502

1756D

siringa per olio da 1500 ml
in polipropilene

- Doppia guarnizione in NBR
- Temperatura di funzionamento: +0 - +50°C
- Non adatta per carburanti



1756D	€		
	83,50	1	017560515

1756E

siringa a sifone compatibile con benzina



1756E	€		
	43,00	1	017560610

1756G

siringa per gasolio
capacità 1,5 l

- Utilizzabile per:
- riempimento filtri gasolio
 - riempimento serbatoio cerina



Compresi nel kit:

- 2 tubi con attacchi rapidi femmina per collegamento tubi gasolio
- 2 attacchi rapidi maschio in metallo
- 1 adattatore conico per tubi gomma

1756G	€		
	128,00	1	017560615

1756G	€		
	128,00	1	017560615

1756C-20R

coppia di O-ring per siringhe 1756C

1756C-20R	€		
	4,75	1	017560503

1756D-20R

coppia di O-ring per siringhe 1756D

1756D-20R	€		
	7,90	1	017560516

1757

rabbocicatori per liquidi batterie



cc	D mm	€		
250	60	3,75	4	017570002
500	75	4,55	4	017570004
1000	90	6,25	2	017570006

1757A

colmatore per liquidi batterie



cc	€		
2000	46,00	1	017570020

1758

imbuto autoadattante

particolarmente utile per auto
prive di profondità all'interno
del tappo di carico



1758	€		
	57,50	1	017580020

1758ADB-D

imbuto antiriflusso per AdBlue®
con attacco dritto



1758 ADB-D	€		
	37,00	1	017580050

1758ADB-45°

imbuto antiriflusso per AdBlue®
con attacco a 45°



1758 ADB-45 Max 1 € 39,50 1 017580060

1758A

imbuto antiriflusso
con attacco rapido Ø 38 mm
Particolarmente indicato per vetture
del gruppo Volkswagen



1758A € 88,50 1 017580010

1758B

imbuto antiriflusso
con attacchi rapidi
Particolarmente indicato
per vetture gruppo VAG



1758B € 38,50 1 017580030

1758B-1,6

imbuto antiriflusso da 1600 ml
con attacchi rapidi
attacchi rapidi
per vetture gruppo VAG



1758B-1,6 H1 H2 Ø
mm mm mm € 43,00 1 017580033

1758B-RNT

attacco rapido antiriflusso
per imbuto 1758B e 1758B-1,6

per motore Renault 1.5 dCi



1758B-RNT € 27,50 1 017580035

1758B/K5

kit di adattatori rapidi antiriflusso
per imbuto 1758B e 1758B-1,6

Inclusi nel kit:

- 1 adattatore per motore 1.5 dCi Renault, Dacia, Nissan
- 1 adattatore per motori 1.5/1.6 dCi Renault, Dacia, Nissan
- 1 adattatore per motore 3.0 BMW diesel
- 1 adattatore per motori 1.5/2.0 benzina gruppo VAG
- 1 adattatore di collegamento con l'imbuto con rubinetto



1758B/K5 € 109,50 1 017580040

1758RD

imbuto con attacchi rapidi per liquido
refrigerante



H Ø
mm mm € 119,00 1 017580070

1758S

supporto a parete per imbuto 1758 ed attacchi
rapidi



1758S € 89,00 1 017580080

1758LG

lamina modellabile in alluminio rivestita in
gomma, per la canalizzazione dei liquidi

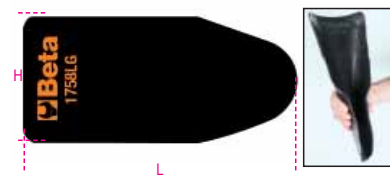

L H
mm mm € 49,00 1 017580006

1758M

imbuto



L
mm € 14,50 1 017580000

1758R

recipienti per liquidi

pratico beccuccio flessibile removibile



	lit	€		
1758R 1	1	9,10	1	017580201
1758R 2	2	10,90	1	017580202
1758R 3	3	19,40	1	017580203
1758R 5	5	23,60	1	017580205

1758VT

kit per la verifica delle testate

segnala rapidamente se nella vaschetta d'espansione è presente anidride carbonica.



1758VT	€	186,50	1	017580100
--------	---	--------	---	-----------

290x190x50 mm - 1 kg

1758VT/L

liquido di contrasto per verifica testate



1758VT/L	€	53,50	1	017580101
----------	---	-------	---	-----------

1759

analizzatore ottico per liquidi di raffreddamento, batteria, lavavetri e AdBlue® in astuccio rigido

Compensazione automatica della temperatura

Acido batteria: intervallo di misura da 1,1 a 1,3 kg/l

Liquido di raffreddamento propilene: da -25°C a -50°C

Liquido di raffreddamento etilene: da -25°C a -50°C

Liquido lavavetri: da -10°C a -40°C

AdBlue(R): Misurazione percentuale di urea da 30% a 35%



1759	€	172,50	1	017590251
------	---	--------	---	-----------

1759A

densimetro per liquido anticongelante



1759A	L mm	€	72,50	1	017590001
	340				

1759B

densimetro per liquidi batteria



1759B	L mm	€	47,50	1	017590005
	280				

1759HD/3

strumenti per controllo tenuta impianto di raffreddamento e riempimento circuito

Permette di verificare sotto pressione le perdite del circuito (tubi, giunti, pompe, radiatori) e riempire velocemente il circuito evitando la formazione di bolle d'aria.



1759HD/3	€	608,00	1	017590063
----------	---	--------	---	-----------

600x500x140 mm - 6,5 kg

1759HD/RR

strumento per riempimento impianto di raffreddamento



1759HD/RR	€	186,50	1	017590064
-----------	---	--------	---	-----------

450x310x110 mm - 2,2 kg



1759LR

attrezzo per lavaggio
impianti di raffreddamento

grazie all'aria compressa,
l'elevata pressione dell'acqua
permette un lavaggio efficace dell'impianto di
raffreddamento

- inclusi 6 adattatori per connessione con impianto
- leva di azionamento con blocco della posizione per un utilizzo continuo
- attacco rapido acqua incluso



L
mm
1759LR 402 € 467,00 1 017590070
390X330X100

1759HD/TRUCK

strumento per controllo e tenuta
impianto di raffreddamento Truck



€ 423,00 1 017590065
440x330x100 mm - 3 kg

1759TT

kit 4 coppie tappi verifica circuito turbo
utilizzabile con pistole gonfiagomme



€ 224,50 1 017590300
400x160x100 mm - 1,8 kg

SERVIZIO DI CERTIFICAZIONE STRUMENTI ELETTRONICI

La certificazione di strumenti
elettronici di misura quali Multimetri,
Pinze Amperometriche, **Tachimetri**
e Termometri è indispensabile in
quei settori o ambiti di applicazione
in cui è necessario conoscere
e controllare l'esattezza della
misura in modo inequivocabile e
riconoscibile.

Per i termometri infrarossi viene
rilasciato un rapporto di taratura su
4 punti (minimo, massimo e due
punti intermedi) con riferibilità ENAC.

**Beta Utensili S.p.A. fornisce
su richiesta il servizio di
certificazione. Per usufruire di
questo servizio rivolgetevi al tuo
rivenditore di fiducia.**



1760DGT

multimetro digitale automotive

CE



195
mm



92 mm

Dati Tecnici:

- RPM (tachimetro):
Per motori a 2 e 4 cilindri
RPM4 600 - 4000 RPM
RPM4 600 - 12000 RPM (x10 RPM)
RPM2/DIS 300 - 4000 RPM
RPM2/DIS 300 - 6000 RPM (x10 RPM)
- Angolo Dwell: 4-8 CYL
- Tensione DC: 400mV-4/40/400/1000V
- Tensione AC: 4/40/400/700V
- Corrente DC: 40/400mA-4/20A
- Corrente AC: 40/400mA-4/20A
- Resistenza: 400Ω-4/40/400kΩ-4/40MΩ
- Capacità: 40/400nF-4/40/100μF
- Frequenza: 5/50/500Hz-50/500-10MHz
- Duty Cycle: 0.1 - 99,9%
- Ampiezza pulsazioni: 1 - 10ms
- Prova diodi: Corrente test 0,3mA
- Continuità: <150Ω - Corrente test <0,3mA
- Display: LCD ad alto contrasto 4 digit retro-illuminato
- Sovratensione: Categoria II 1000V
- Autospegnimento: 30 minuti
- Alimentazione: 1 batteria 9V (inclusa)
- Pinza induttiva (inclusa)
- 2 Puntali (inclusi)
- Custodia morbida in tela (inclusa)
- Manuale d'uso

€ 285,00 1 017600005



1760DGT/2

multimetro digitale automotive portatile con oscilloscopio a 2 canali e generatore d'onda



Il kit include:

- Puntali multimetro
- 2 connettori coccodrillo BNC per oscilloscopio
- Sonda a puntale per oscilloscopio (1X e 10X)
- Caricabatteria
- Custodia in nylon

Dati tecnici:

- Display: TFT a colori da 2,8"
- Risoluzione: 320 x 240 pixels
- Alimentazione: 100V-240V AC, 50Hz-60Hz; DC INPUT 5V DC-2A
- Batteria: 2 x 2600 mAh
- Peso: 624 g
- Dimensioni: 199 x 98 x 40 mm

Specifiche multimetro:

- Test: Tensione, Corrente, Resistenza, Capacità, Diodi e On-Off
- Tensione Max: 600V AC-DC
- Corrente Max: 10A AC-DC
- Resistenza Max: 40MOHM
- Capacità Max: 100uF

Specifiche oscilloscopio:

Orizzontale

- Larghezza banda: 40MHz
- Intervallo di frequenza campionamento: 250MSa/s (singolo canale) - 125MSa/s (doppio canale)
- Gamma SEC/DIV: 5ns/div ÷ 500s/div 1,2,5 sequence

Verticale

- Gamma VOLTS/DIV: 10mV/div ÷ 10V/div ingresso BNC
- Analogico selezionabile limite larghezza di banda, tipico: 20MHz
- Risposta a bassa frequenza (-3db): ≤10Hz a BNC
- DC Gain Accuracy: ± 3% per la modalità di acquisizione Normale o Media, da 10V/div a 10 mV/div

Trigger

- Type: Edge
- Mode: Auto, Normal, Single
- Slope: Rising, Falling, Rising, & Falling
- Source: CH1, CH2

Ingresso

- Accoppiamento: DC, AC o GND
- Fattori di attenuazione della sonda supportati: 1X, 10X, 100X, 1000X

Generatore di forma d'onda arbitraria

- Frequenza forma d'onda: Sine (1Hz÷25MHz), Square (1Hz÷10MHz), Ramp (1Hz÷1MHz), EXP (1Hz÷5MHz)
- Ampiezza: 2.5Vpp (50Ω) - 5Vpp (alta impedenza)
- Impedenza di uscita: 50Ω

1760DGT/2

€ 795,00



1

017600008

1760B

multimetro digitale



Parametri rilevabili:

- Tensione DC: 200 mV-2/20/200/1000V
- Tensione AC: 2-20/200/700V
- Corrente DC: 2/20/200 mA-20 A
- Corrente AC: 2/200 mA- 20 A
- Resistenza: 200Ω - 2/20/200 kΩ - 2/20 MΩ
- Capacità: 2/20/200 nF - 2/200 μF
- Temperatura: -20° + 1000°C/ -4 °F ~ +2000°F
- Frequenza: 20kHz
- Alimentazione: 1 batteria da 9V (inclusa)

1760B

€ 184,00



1

017600012

1760/OHM

multimetro/megaohmetro per test isolamento ad alta tensione.

con lettura a valore efficace TRUE RMS



	Campo di misura	Precisione base
Tensione AC/DC:	50mV - 1000V	±0.06% - ±0.1% rdg
Corrente AC/DC:	0.01μA - 10A	±0.5% - ±1% rdg
Resistenza :	0.01Ω - 50MΩ	±0.2% - ±2% rdg
Meg OHM:	0.01 - 5000MΩ	±4% rdg. max current
1mA		
Capacità:	5nF - 10mF	±1.5% - ±3% rdg
Frequenza:	50Hz - 100 MHz	±0.02% - ±0.1% rdg
Temperatura:	-50°C - +1350°C	±0.5% rdg
Test diodi:	3V dc	
Test continuità:	<30 Ω	

1760/OHM

€ 872,00



1

017600025

1760/RMS

multimetro industriale IP67

con lettura a valore efficace TRUE RMS

EN61010-1
EN61326-1



Dettagli tecnici:

- Campo di misura Precisione base
- Tensione AC/DC 110mV - 600V ±0.8% - ±2% rdg
- Corrente AC/DC 110μA - 10A ±1.5% - ±2% rdg
- Resistenza 110Ω - 40MΩ ±1.2% - ±2.5% rdg
- Capacità 11nF - 40mF ±5% - ±10% rdg (fino a 11mF)
- Frequenza 1100Hz - 110 MHz ±1.2% - ±1.5% rdg
- Temperatura -32°C - +1000°C ±3% - ±5% rdg
- Test diodi 3V dc ±10% rdg
- Test continuità <30 Ω

1760/RMS

€ 316,00



1

017600020

1760S

multimetro digitale compatto

con lettura a valore efficace TRUE RMS



Parametri rilevabili:

- Tensione DC: 200 mV-2/20/200/600V
- Tensione AC: 100/600V
- Corrente DC: 200 mA-10 A
- Corrente AC: 0.01-10 A
- Resistenza: 200Ω - 2/20/200 kΩ - 2 MΩ
- Test diodi: da 0.4 a 0.7 V dc
- Alimentazione: 2 batterie 1,5V tipo AAA

1760S

€ 91,00



1

017600022

153x75x42 mm

1760PA/80

pinza amperometrica AC/DC 80A

per misurazione di bassi valori
di dispersione della corrente o assorbimenti sui veicoli



CE

Caratteristiche:

- Range: 1mA-80A AC/DC
- Funzione torcia con LED bianco
- Display LCD retroilluminato
- Funzione azzeramento
- Funzione Hold
- Autospegnimento
- Alimentazione: 2 batterie 1,5V tipo AAA

1760PA/80 € 237,00 1 017600002

1760PA/AC

pinza amperometrica e multimetro digitale

A: AC
V: AC/DC

CE



Parametri rilevabili:

- Tensione DC: 400 mV - 4/40/400/600 V
- Tensione AC: 400 mV - 4/40/400/600 V
- Corrente AC: 40/400/1000 A
- Resistenza: 400Ω - 4/40/400 kΩ - 4/40 MΩ
- Frequenza: 5/50/500 Hz - 5/50/500 kHz - 5/10 MHz
- Capacità: 40/400 nF - 4/40/100 μF
- Temperatura: -20°C + 1000°C / -4 °F + 1832 °F
- Alimentazione: 1 batteria da 9V (inclusa)

1760PA/AC L mm 190 € 194,00 1 017600050

1760PA/AC-DC

pinza amperometrica e multimetro digitale

A: AC/DC
V: AC/DC

CE



Parametri rilevabili:

- Tensione DC: 0.1mV ÷ 600V
- Tensione AC: 0.1mV ÷ 600V
- Corrente AC: 0.01A ÷ 1000A
- Corrente DC: 0.01A ÷ 1000A
- Resistenza: 0.1Ω ÷ 40MΩ
- Capacità: 0.001nF ÷ 40 μF
- Frequenza: 0.001kHz ÷ 4kHz
- Temperatura: -40°C ÷ 1000 °C -40°F ÷ 1832°F
- Alimentazione: 1 batteria da 9V (inclusa)

1760PA/AC-DC € 352,00 1 017600000

1760PA/AC-DC2000

pinza amperometrica con multimetro digitale e connessione dati

funzione TRUE RMS nelle misure in AC

A: AC/DC
V: AC/DC

CE



Parametri rilevabili:

- Tensione DC: 0.1mV ÷ 1000V
- Tensione AC: 0.1mV ÷ 1000V
- Corrente AC: 0.01A ÷ 2000A
- Corrente DC: 0.01A ÷ 2000A
- Resistenza: 0.1Ω ÷ 60MΩ
- Capacità: 1nF ÷ 6000 μF
- Frequenza: 10kHz ÷ 20kHz
- Temperatura: -20°C ÷ 1000 °C -4°F ÷ 1832°F
- Alimentazione: 3 batterie da 1,5V tipo AA (incluse)
- Connessione tramite app per scaricare i dati

H mm 300 L mm 110 P mm 43 € 694,00 1 017600003

380x280x100 mm - 1,78 kg

1760DGT-R3

puntali di ricambio per multimetri digitali e pinze amperometriche



1760DGT-R3 € 24,70 1 017600603

1760/RSE

rilevatore di segnale

Permette di testare l'alimentazione di componenti come:
elettroiniettori Common Rail, elettroiniettori benzina/GPL,
iniettori piezoelettrici, elettrovalvole regolatrici flusso/
elettrovalvole EGR, bobine e altri



CE

Per effettuare la diagnosi dei singoli componenti dell'impianto elettrico è sufficiente avvicinare la sonda al componente in esame.

In impianti con componenti elettromeccanici/elettronici comandati da una centralina, lo strumento permette di verificare se:

- La centralina di gestione è alimentata e assolve il suo compito di comando
- Il cablaggio della centralina al componente è efficiente
- Il componente in esame non è interrotto
- Il componente non è in cortocircuito
- Il componente è elettronicamente funzionante

1760/RSE € 493,00 1 017600170



Beta

1760/TC2

tachimetro digitale a distanza e a contatto



Dati tecnici:

- Per misurazione di:
 - Rotazione a distanza (g/min - rpm)
 - Rotazione (g/min - rpm) e velocità lineare (m/min o ft/min) a contatto
- Display LCD a 5 cifre
- Scala:
 - A distanza 2,5÷99.999 g/min
 - A contatto 0,5÷19.999 g/min
 - Velocità lineare 0,05÷1.999,9 m/min.
- Frequenza: 0,8 sec
- Alimentazione: 4 batterie 1,5V (AA) (include) o alimentatore 6V (non incluso)
- Fornito con:
 - Adattatore per misurazioni a contatto
 - 2 puntali maschio in gomma
 - 1 puntale femmina in gomma
 - 1 rotella per rilevazioni lineari
 - Etichette riflettenti
 - Manuale di istruzioni
 - Custodia in plastica

	L	H	€		
1760/TC2	230	74	246,00	1	017600161

1760R/TC2

etichette riflettenti per 1760/TC2



1760R/TC2	€		
	21,80	1	017600561

1760K

rilevatore di tensione AC senza contatto con mini torcia LED

campo: 200-1000Vac 50/60Hz
 CAT III-1000V
 funzionamento con 2 pile AAA (include)



1760K	€		
	39,50	1	017600140

1760PT

tester combinato di tensione e continuità 12-690V AC/DC

funzioni:

- continuità
- rotazione fasi
- cercafase
- torcia LED



IP64
 CATIV
 - 600V ;
 CATIII
 - 1000V

1760PT	€		
	158,50	1	017600150

1760/IR500

termometro digitale ad infrarossi con doppio puntamento laser

non idoneo alla misurazione della temperatura corporea



Dati tecnici:

- Range temperatura: -50 + 500 °C (-22 a 932 °F)
- Risoluzione display: 0,1 °C (0,1 °F)
- Emissività: regolabile 0,1 ÷ 1
- Precisione: -50 a 20°C (+/- 3°C); 20 + 500°C (+/-2% o 2°C)
- Risoluzione ottica (D:S): 12:1
- Auto Spegnimento: circa 10 secondi
- Temperatura di funzionamento: 0 + 50°C
- Temperatura di stoccaggio: -20 + 60°C
- Alimentazione: 1 batteria 9 V

1760/IR500	€		
	169,50	1	017600350

1760/IR1000

termometro digitale ad infrarossi con doppio puntamento laser

non idoneo alla misurazione della temperatura corporea



Dati tecnici:

- Range temperatura: -50 + 1000 °C (-58 + 1832 °F)
- Risoluzione display: 0,1 °C (0,1 °F)
- Emissività: regolabile 0,1 ÷ 1
- Precisione: -50 + 20°C (+/- 3,5°C); 20 + 300°C (+/-1% o 1°C); 300 + 1000°C (+/-1,5%)
- Risoluzione ottica (D:S): 20:1
- Temperatura di funzionamento: 0 + 50°C
- Temperatura di stoccaggio: -10 + 60°C
- Alimentazione: 2 batterie 1,5 V (tipo AAA)

1760/IR1000	€		
	280,00	1	017600400

1760/IR1600

termometro digitale ad infrarossi con doppio puntamento laser

non idoneo alla misurazione della temperatura corporea



Dati tecnici:

- Gamma: da -50°C a 1600°C / da -58°F a 2912°F
- Selezione scala: °C/°F
- Precisione: ±1,5% o ±2°C a 20°C
- Potenza Laser: <1mW
- Risposta: 150ms
- Emissività: 0,10-1,0 regolabile
- Rapporto distanza: (D:S) 50:1
- Temperatura operativa: 0°C + 50°C / 32°F + 122°F
- Umidità operativa: da 0% a 100% RH
- Display LCD retro-illuminato
- Funzione di mantenimento dei dati
- Auto spegnimento
- Presa tipo K
- Presa mini USB

Cavo USB per scarico dei dati
 CD per installazione software datalogger
 Alimentazione: 1 batteria 9V (inclusa)

Custodia rigida e treppiede in alluminio
 Manuale d'uso

1760/IR1600	mm	mm	€		
	200	115	783,00	1	017600461



1760LX

luxmetro digitale portatile

EN61010-1
EN61326-1



Dettagli tecnici:

- Campo di misura Precisione base
- Luminosità Lux 0-200000 ±3%
- Luminosità FC 0-20000 ±3%
- Alimentazione: 1 x 9V

1760LX	L mm	165	€	107,00	1	017600820
--------	---------	-----	---	--------	---	-----------

1760TMC

termocamera a infrarossi

Termocamera compatta per la misurazione della temperatura senza contatto, adatta per applicazioni nei settori edile, meccanica, impianti elettrici e di riscaldamento

- Temperatura da -20 ÷ +600°C.
- Display LCD TFT da 2 pollici 240x320.
- Sensore da 32x32 pixel.
- Frequenza di acquisizione 7Hz.
- Termosensibilità <254mK.
- Acquisizione automatica dei punti caldi e freddi.
- Fotocamera di acquisizione immagini in formato BMP (massimo 100 immagini).
- Emissività regolabile.
- Alimentazione 3 batterie alkaline AAA.
- Interfaccia USB.
- IP54
- Banda infrarossi 6,5+14µm.
- Distanza di fusione visibile/infrarosso 0,5; 1; 2 m.
- Funzione allarme, selezionando la temperatura massima e minima accettabili.



1760TMC 600	€	896,00	1	017600710
-------------	---	--------	---	-----------

1760WM

anemometro digitale con sensore a ventola

EN61010-1
EN61326-1



Dettagli tecnici:

- Campo di misura Precisione base
- Velocità m/s 0,4-30 ±2%
- Velocità k/n 1,4-108 ±2%
- Velocità ft/m 80-5900 ±2%
- Velocità mil/h 0,8-58 ±2%
- Flusso CFM 0-99990 ±0-9,999 ft2
- Flusso CMM 0-99990 ±0-9,999 m2
- Flusso CMS 0-99990 ±0-9,999 m2

1760WM	L mm	170	€	86,50	1	017600800
--------	---------	-----	---	-------	---	-----------

1761

pinza torcifilo a ritorno automatico

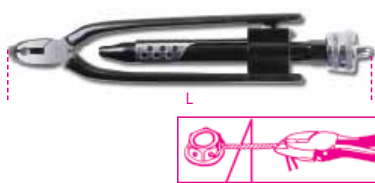

L mm	255	€	69,50	1	017610101
---------	-----	---	-------	---	-----------

1761RS/1

pinza torcifilo reversibile a ritorno automatico



L mm	220	€	124,00	1	017610130
---------	-----	---	--------	---	-----------

1762

pinza fustellatrice



Ø mm	L mm	€	32,50	2	017620001
2-2,5-3	210				
3,5-4-4,5					

1763

pinza per graffette tappezzerie auto



1763	€	38,00	1	017630001
------	---	-------	---	-----------

1763G/S500

500 graffette per tappezzerie auto



1763G/S500	€	71,50	1	017630105
------------	---	-------	---	-----------

1764/K5

rivettatrice manuale per rivetti in plastica

fornita con 4 misure di rivetti

inclusi nel kit:

- 10 rivetti Ø 5x17,2 mm
- 10 rivetti Ø 5x15,8 mm
- 10 rivetti Ø 6,3x25,2 mm
- 10 rivetti Ø 6,6x17,2 mm



1764/K5	€	55,50	1	017640001
---------	---	-------	---	-----------

1764/K5-R

confezione 20 rivetti in plastica per 1764/K5



1764/K5-R1	5X17,2	€	15,20	1	017640003
1764/K5-R2	5X15,8	€	15,20	1	017640004
1764/K5-R3	6,3X25,2	€	15,20	1	017640005
1764/K5-R4	6,6X17,2	€	15,20	1	017640006

1765/C24

cassetta di 24 attrezzi
per estrazione autoradio



1765/C24 € 207,00 1 017650001

1766

ventosa doppia



max kg 50 € 129,00 2 017660001

1766A

ventosa singola



max kg 30 € 33,00 2 017660005

1766/8

assortimento di 8 utensili
per cristalli auto

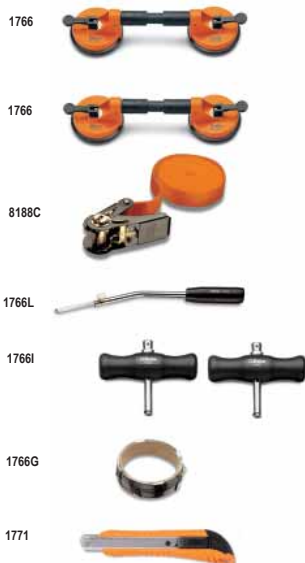

1766/8 € 480,00 1 017660100

1766ER

estrattore per raschiavetri
con impugnatura

permette di rimuovere agevolmente
i raschiavetri senza rischi di danneggiamenti



1766ER € 23,40 1 017660501

1766ER/VW

estrattore a basso profilo
per raschiavetri
particolarmente indicato per raschiavetri gruppo VAG
con limitato spazio di presa

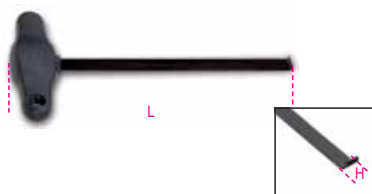

L mm 215 H mm 4 € 16,60 1 017660510

1766L

leva per cristalli



1766L € 54,00 1 017660015

1766LI

leva per inserimento cavo tagliacristalli

bordi affilati per taglio sigillante



1766LI € 19,20 1 017660016

1766I

impugnatura per cavo d'acciaio 1766G e V



1766I € 52,50 2 017660020

1766G

cavo d'acciaio per cristalli

sezione quadrata



50 m € 46,50 1 017660025

1766T

cavo d'acciaio per cristalli

sezione triangolare



50 m € 54,00 1 017660026



1767A

asta telescopica

- ideata per sostenere cofani e portelloni con pistoni scarichi
- utilizzabile per mantenere i pedali bloccati

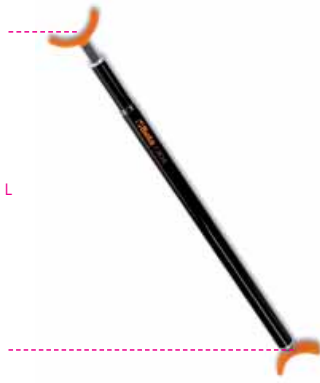

L
mm
640 ÷ 1090 € 73,00 1 017670000

1767B

kit blocca pedali e volante

grazie alla regolazione a pistola è possibile effettuare delle precise impostazioni quando si tiene il veicolo accelerato



1767B € 156,50 1 017670100

490x285x95 mm - 2,4 kg

1767PMC

portaminuterie magnetico tondo



1767PMC € 22,90 1 017670020

1767PMR

portaminuterie magnetico rettangolare



1767PMR € 46,50 1 017670010

1768

pedana in alluminio

superficie rivestita in materiale antiscivolo portata massima 200 kg

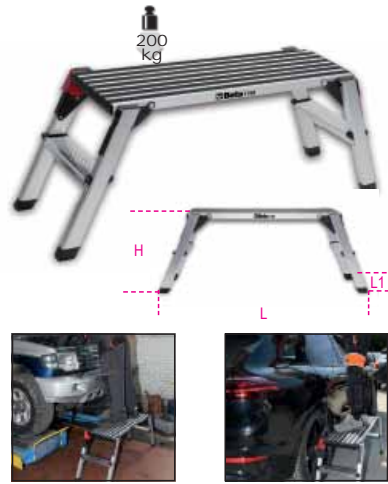

L mm 960 L1 mm 300 H mm 475 € 201,50 1 017680010

1770

cutter extra piatto fornito con 2 lame



1770 L mm 140 A mm 9 € 17,50 10 017700001

1770A

cutter 9mm con blocco automatico della lama, fornito con 3 lame

• cursore di sicurezza antiritorno



1770A L mm 135 A mm 9 € 6,55 10 017700025

1770RL

10 lame a settori 9 mm per cutter 1770, 1770A e 1770BM



1770RL € 5,80 5 017700010

1770BM

cutter 9 mm, fornito con 6 lame

• Caricamento automatico della lama



1770BM L mm 140 A mm 9 € 13,40 10 017700050

1771

cutter 18 mm fornito con 3 lame



1771 € 9,95 10 017710000

1771BM

cutter 18 mm fornito con 6 lame

• Caricamento automatico della lama



1771BM L mm 170 A mm 18 € 21,70 10 017710050

1771HD

cutter 18 mm fornito con 6 lame

• Caricamento automatico della lama
• Sistema bloccalama a vite



1771HD L mm 190 A mm 18 € 24,40 5 017710100

1771RL

10 lame a settori 18 mm per cutter 1771, 1771BM e 1771HD



1771RL € 8,35 5 017710010

1772M

cutter a lama retrattile di sicurezza fornito con 4 lame

• Lama con rientro automatico a molla
• Corpo in lega pressofusa
• Levapunti integrato nel manico



1772M L mm 170 A mm 18 € 19,80 5 017720040

1772R

cutter a lama trapezoidale retrattile, fornito con 5 lame

- Caricamento automatico della lama



1772R	L mm	A mm	€	5	017720006
	125	18	18,30		

1772H

cutter a lama retrattile di sicurezza, fornito con 2 lame



1772H	L mm	A mm	€	5	017720029
	170	18	19,30		

1772RL/2

10 lame trapezoidali lunghe, in astuccio, per cutter 1772H, 1772M, 1772R, 1774, 1777BMT, 1777T

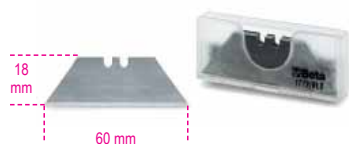

1772RL/2	€	5	017720017
	4,65		

1773A

cutter 25 mm

- Sistema bloccalama a ghiera
- Lama da 25 mm



1773A	L mm	A mm	€	10	017730000
	180	25	19,30		

1773RL

10 lame a settori 25 mm per cutter 1773A



1773RL	€	5	017730015
	18,90		

1773S

cutter di sicurezza a lama circolare

- Lama principale Ø 28 mm
- Lama secondaria per tagliare le pellicole
- Foro per appendibilità



1773S	L mm	A mm	€	1	017730100
	190	28	9,00		

1773S/RL

3 lame circolari Ø28 mm per cutter 1773S



1773S/RL	€	5	017730110
	4,00		

1774

raschietto multiuso con salvalama di protezione



1774	L mm	L1 mm	€	5	017740001
	155	60	4,50		

1774A

raschietto multiuso con impugnatura bimateriale



1774A	L mm	A mm	€	1	017740011
	300	40	14,00		

1774A/RL

10 lame per raschietto 1774A e 1774S

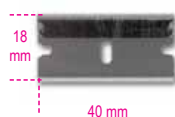

1774A/RL	€	1	017740511
	6,65		

1774S

raschietti per rimozione adesivi



1774S	A mm	L mm	€	2	017740021
	40	100	7,55		

1777BM

coltello a serramanico con gola spellafili lama in acciaio inossidabile



1777BM	L mm	L1 mm	A mm	€	5	017770100
	190	80	16	12,60		

1777T

cutter a serramanico con lama trapezoidale impugnatura in alluminio, fornito con 5 lame



1777T	L mm	A mm	L1 mm	€	5	017770030
	160	19	65	27,50		

1777BMT

cutter a serramanico con lama trapezoidale 4 profondità regolabili della lama 4; 9.5; 15.5; 21.5 mm fornito con 3 lame



1777BMT	L mm	L1 mm	A mm	€	5	017770050
	170	80	19	29,50		

1778AN

coltello a serramanico lama in acciaio inossidabile impugnatura leggera in alluminio anodizzato* in astuccio



1778AN	L mm	A mm	L1 mm	€	5	017780065
	204	26	84	34,00		

1778AX

coltello a serramanico
lama in acciaio inossidabile seghettata,
impugnatura in alluminio,
con dentello apertura agevolata,
• in astuccio



	L mm	A mm	L1 mm	€	5	017780026
1778AX	189	26	80	37,00		

1778BS

coltello a serramanico
con doppia sicurezza,
lama in acciaio inossidabile seghettata
e finitura carbon look
• in astuccio



	L mm	A mm	L1 mm	€	10	017780035
1778BS	200	29	85	37,00		

1778CM

coltello a serramanico mimetico
lama in acciaio temprato
• in astuccio



	L mm	A mm	L1 mm	€	5	017780099
1778CM	195	24	80	35,00		

1778M7

coltello a serramanico **mini**
lama in acciaio inossidabile
impugnatura con inserti in fibra di vetro
• in astuccio



	L mm	A mm	L1 mm	€	5	017780015
1778M7	163	24	68	30,00		

1778P

coltello a serramanico
lama ed impugnatura in acciaio inossidabile e
alluminio,
con apertura a pulsante
• in astuccio



	L mm	A mm	L1 mm	€	5	017780088
1778P	193	29	72	40,00		

1778SCL

coltello a serramanico con finitura soft carbon
look
lama in acciaio temprato
• in astuccio



	L mm	A mm	L1 mm	€	5	017780089
1778SCL	180	22	78	33,00		

1778SOS

coltello soccorso auto
con funzione martello frangicristallo
e tagliacinture di sicurezza
• in astuccio



	L mm	A mm	L1 mm	€	5	017780080
1778SOS	205	25	85	35,00		

1778V18

coltello a serramanico
impugnatura in alluminio
• in astuccio



	L mm	A mm	L1 mm	€	5	017780018
1778V18	195	25	85	33,00		

1778X

coltelli per nautica in acciaio inossidabile
impugnatura in alluminio



	L mm	L1 mm	A mm	€	2	017780050
1778X	185	85	25	32,00		



1778MT - MULTITOOL

L'utensile multifunzione BETA si distingue dagli articoli simili presenti in commercio per caratteristiche che denotano la sua origine BETA: pinza di qualità incomparabile, utilizzo di materiali ricercati ed elevato contenuto tecnologico. La presenza di **11 inserti**, aventi le geometrie più presenti sul mercato, rende questo articolo ideale per ogni ambiente e condizione di lavoro, dal campeggio alla nautica, dalla caccia al fai da te.



22 FUNZIONI

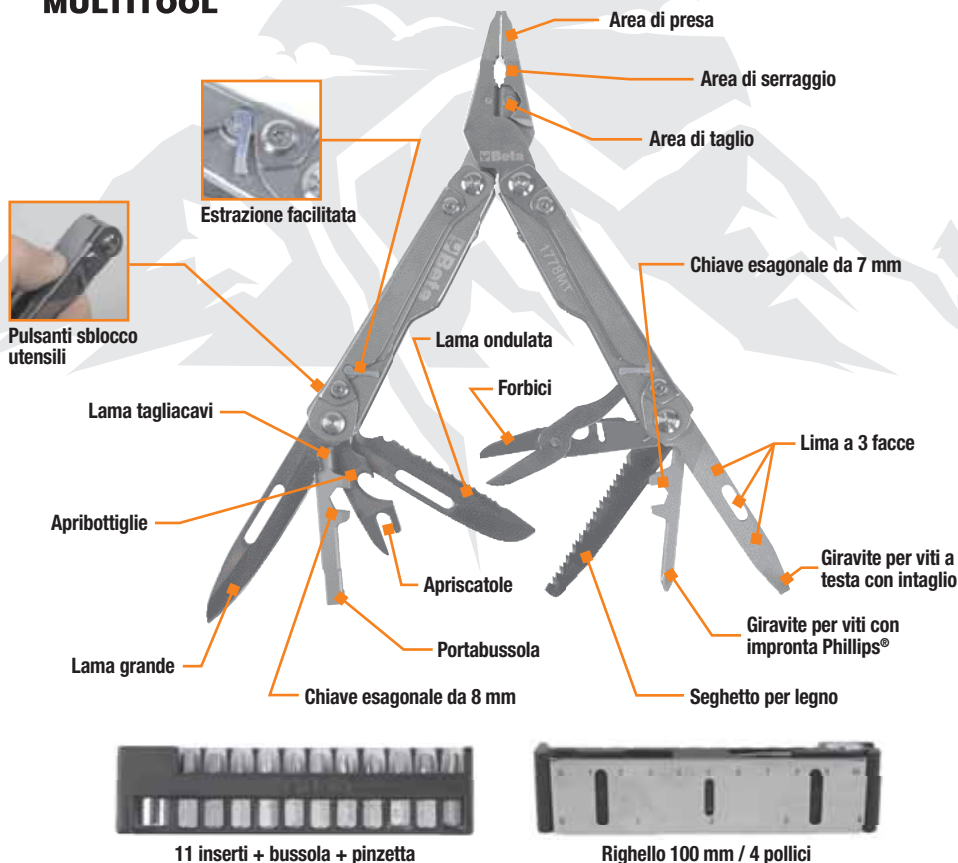

11 inserti + bussola + pinzetta



Righello 100 mm / 4 pollici

1778MT

utensili multifunzione
completi di inserti e fodero
9 utensili
22 funzioni



L mm	L1 mm	€	Icona	Icona	Articolo
180	115	105,00	1	1	017780055

1781

forbici a lame lunghe sottili



L mm	€	Icona	Icona	Articolo
132	19,40	2	2	017810001

1783

forbici modello leggero



L mm	€	Icona	Icona	Articolo
215	16,10	5	5	017830021
240	18,00	5	5	017830024

1784

forbici modello pesante



L mm	€	Icona	Icona	Articolo
175	23,10	2	2	017840017
200	31,00	2	2	017840020
250	41,00	2	2	017840025
300	55,50	2	2	017840030

1800/100

cuscini sollevatori (max 135 kg)

- sollevare-livellare
- bloccare porte ed ante



A mm	B mm	S mm	€	Icona	Icona	Articolo
160	150	2+55	62,50	3	3	018000000



Beta

ILLUMINAZIONE

La famiglia Illuminazione comprende una vasta gamma di prodotti studiati per soddisfare le esigenze di tutti gli utilizzatori, a partire dalla ispezione di piccoli condotti fino all'illuminazione di ampie aree di lavoro.

TORCE

Il nuovo design accattivante, i miglioramenti tecnici e l'ampia offerta di misure, consentono di scegliere la torcia più adatta in base alla luminosità, alla autonomia e alle prestazioni.

LAMPADE E FARI

Grazie al miglioramento della tecnologia LED, all'aumentata durata delle batterie, alla riduzione dei tempi di ricarica, alla particolare attenzione ai materiali e alla costante ricerca di soluzioni innovative, le lampade da lavoro Beta rappresentano un ottimo connubio di design, praticità e prestazioni. Una gamma completa per consentire al professionista di svolgere al meglio il proprio lavoro, in qualsiasi settore e in qualsiasi condizione.

WIRELESS

 La nuova tecnologia wireless consente la carica dei più recenti fari e lampade attraverso un'unica base di ricarica 1839BRW. Attraverso la nuova base è possibile caricare contemporaneamente i più recenti fari e lampade senza dover necessariamente ricorrere ai cavi. Inoltre, grazie al supporto estraibile, è possibile ricaricare anche il telefono cellulare.



CRI - Color Rendering Index
CCT - Correlated Color Temperature

FARI							
ITEM	LUMEN	BATTERIA	TEMPO RICARICA	DURATA	IP/IK	CCT	CRI
1837C/2100	500 - 1000 - 2100	Li-Ion 11.1V; 4400 mAh	4.0h	9 - 2.5h	IP65 - IK07	6500K	80+
1837C/4300	1100 - 2100 - 4300	Li-Ion 11.1V; 5200 mAh	4.0h	6 - 1.5h	IP65 - IK07	6500K	80+
1837M	500 - 1000 - 2000	Li-Ion 11.1 V; 5200 mAh	3.5h	2 - 8h	IP65 - IK07	2700-3500-4500-5500-6500K	96+
1838FLASH	360 - 720	Li-Ion 7.4 V; 4000 mAh	4.0h	4 - 8h	IP65	6300K	-
1838POCKET	160 - 400 - 800	Li-Ion 3.7 V; 2600 mAh	4.0h	3 - 9h	IP65	6500K	80+

LAMPADE							
ITEM	LUMEN	BATTERIA	TEMPO RICARICA	DURATA	IP/IK	CCT	CRI
1838/11LED	320	Li-Ion 3.7V; 4200 mAh	4.0h	4h	IP65	6500K	
1838AM	60 - 700 120 (spot)	Li-Ion 3.7V; 2600 mAh	4.0h - USB-C	2.5 - 16h 10h (spot)	IP54 - IK07	6500K	80+ 70+
1838COB	100 - 200 75 (spot)	Li-Ion 3.7V; 1600 mAh	3.0h	3-6h 4h (spot)	IP65	6000K	80+
1838P	80 - 50	Li-Ion 3.7V; 700 mAh	2.5h	4h	IP20	6000K	80+
1838SLIM	100 - 200 180 (back) 80 (spot)	Li-Ion 3.7 V; 700 mAh	2.5h - USB-C	2 - 4h 2h (back) 3h (spot)	IP54 - IK07	6500K	80
1838UV	75 - 150	Li-Ion 3.7V; 1600 mAh	3.0h	3h	IP20	6000K	80
1838SW	250 - 500 - 1000	Li-Ion 3.6V; 3350 mAh	4.5 - 6.5h	3 - 7h	IP65 - IK07	6500K	80+
1838E	500 - 1000 - 2000	Li-Ion 3.6V; 3350 mAh	4.5 - 6.5h	3 - 9h	IP20 - IK07	5500K	80+

LAMPADE DA TESTA							
ITEM	LUMEN	BATTERIA	TEMPO RICARICA	DURATA	IP/IK	CCT	CRI
1836B	125 - 250	Li-Ion 3.8V; 1600 mAh	3.0h	5h	IP65 - IK07	6000K	80+
1836AW	30 - 200 - 400	Li-Ion 3.7V; 1500 mAh	2.5h	4-18h	IP65 - IK07	6500K	80+

TORCE						
ITEM	LUMEN	BATTERIA	TEMPO RICARICA	DURATA	IP/IK	PORTATA
1833XS/1	100	1 x AAA	-	5h	IP66	85m
1833XS/2	200	2 x AAA	-	10h	IP66	112m
1833S	500	2 x AA	-	10h	IP66	140m
1833M	700	3 x AAA	-	7.5h	IP66	170m
1833L	1100	3 x AA	-	8.5h	IP66	330m
1833L/USB	1200	Li-Ion 3.7 V; 2600 mAh	3.0h - USB-C	3.0h	IP66	230m
1833XSW	80 - 250	Li-Ion 3.7V 2600 mAh	2.0 h	2.0-8.0h	IP54 - IK07	
1833MW	5 - 30 - 400 - 1000	Li-Ion 3.7V; 2600 mAh	4.0 - 6.0 h	2.0-200.0h	IP68 - IK07	
1833XL	1500	3xD	-	22h	IP66	290m
1837F	500	3 x AA	-	14.5h	IP66	125m
1837F/USB	600	Li-Ion 3.7 V; 2900 mAh	4.0h - USB-C	10h	IP66	280m

1833L/USB

torcia LED ricaricabile ad alta luminosità in robusto alluminio anodizzato, fino a 1200 Lumen

- cono luminoso regolabile
- 3 intensità luminose
- durata 3.0h
- IP66
- portata: 230 m
- indicazione di batteria scarica sotto il 15%
- ricarica con attacco USB-C
- caricatore non incluso

DISPONIBILE FINO AD ESAURIMENTO SCORTE



L mm 240 € 121,50 1 018330054

1833RB-L/USB

batteria di ricambio per 1833L/USB

1833RB-L/USB € 56,00 1 018330975

1833XS/1

torcia LED per ispezioni, in robusto alluminio anodizzato

- 100 lumen
- cono luminoso regolabile
- pila 1xAAA (non inclusa)
- IP66
- durata 5.0h
- portata: 85 m



L mm 92 € 21,10 3 018330000

1833XS/2

torcia LED per ispezioni, in robusto alluminio anodizzato

- 200 lumen
- cono luminoso regolabile
- pile 2xAAA (non incluse)
- IP66
- durata 10.0h
- portata: 112 m



L mm 133 € 23,10 3 018330001

1833XSW

torcia a LED per ispezioni con ricarica wireless

- Due intensità luminose: LED SMD, 250 - 80 Lumen
- Batteria ricaricabile: 3,7V 700 mAh., 2.59 Wh Li-ion
- Due modalità di ricarica: base wireless 1839BRW alimentatore con attacco USB-C
- Tempo di ricarica: 2h con base di ricarica wireless 2h con alimentatore
- Autonomia: 2-8h
- Indicatore LED del livello di batteria
- Magneti su base e retro
- Clip da cintura
- IP54
- IK07
- Cavo USB-C incluso



L mm 145 € 49,50 1 018330011

1833S

torcia LED ad alta luminosità in robusto alluminio anodizzato, fino a 500 Lumen

- cono luminoso regolabile
- 2 intensità luminose
- pile 2xAA (non include)
- durata 10.0h
- IP66
- portata: 140 m



L mm 150 € 39,50 1 018330002

1833M

torcia LED ad alta luminosità in robusto alluminio anodizzato, fino a 700 Lumen

- cono luminoso regolabile
- 2 intensità luminose
- pile 3xAAA (non include)
- indicatore di batteria scarica <15%
- durata 7.5h
- IP66
- portata: 170 m



L mm 162 € 49,50 1 018330003

1833MW

torcia a LED ad alta luminosità con ricarica wireless

- Quattro intensità luminose: LED SMD, 1000 - 400 - 30 - 5 Lumen
- Batteria ricaricabile: 3,7V 2600 mAh., 9.62 Wh Li-ion
- Due modalità di ricarica: base wireless 1839BRW alimentatore con attacco USB-C
- Tempo di ricarica: 6h con base di ricarica wireless 4h con alimentatore
- Autonomia: 2-200h
- Indicatore del livello di batteria a 3 led
- Magnete sul retro
- IP68
- IK07
- Cavo USB-C incluso



L mm 160 € 90,50 1 018330013

1833L

torcia LED ad alta luminosità in robusto alluminio anodizzato, fino a 1100 Lumen

- cono luminoso regolabile
- 2 intensità luminose
- pile 3xAA (non include)
- indicatore di batteria scarica <15%
- durata: 8.5h
- IP66
- portata: 330m



L mm 196 € 82,50 1 018330004

1833XL

torcia LED ad alta luminosità in robusto alluminio anodizzato, fino a 1500 Lumen

- cono luminoso regolabile
- 2 intensità luminose
- pile 3xD (non include)
- indicatore di batteria scarica <15%
- durata 22.0h
- IP66
- portata: 290 m



L mm 300 € 103,50 1 018330005

1836AW

lampada da testa a LED con ricarica wireless, con doppia emissione luminosa

- 2 emissioni luminose: principale: 3 intensità luminose LED COB 30 - 200 - 400 lumen spot: LED COB, 400 lumen
- batteria ricaricabile: Li-Ion 3.7 V, 1500 mAh, 5.55 Wh
- 2 modalità di ricarica: base wireless 1839BRW alimentatore con attacco USB-C
- cavo USB-C incluso
- tempo di ricarica: 2.5h
- autonomia: principale: 4-18h spot: 4h
- IP 65
- IK 07



1836AW € 74,50 1 018360051

1836B

lampada da testa ricaricabile a LED, con doppia luminosità e sensore ON/OFF

- Sensore ON/OFF contactless
- Fornita con cavo di ricarica USB/mini jack + caricatore
- 250 Lumen
- Autonomia: 3-6 h
- IP65



1836B € 135,00 1 018360200

1837F

lampada magnetica snodata con LED ad alta luminosità, in robusto alluminio anodizzato, fino a 500 Lumen

- cono luminoso regolabile
- 2 intensità luminose
- pile 3xAA (non include)
- durata 14.5h
- indicatore di carica
- IP66



L mm 460 € 89,50 1 018370050

1837F/USB

lampada **ricaricabile** magnetica snodata con LED ad alta luminosità, in robusto alluminio anodizzato, fino a **600 Lumen**

- cono luminoso regolabile
- 2 intensità luminose
- durata 10.0h
- indicatore di batteria scarica <15%
- ricarica con attacco USB-C
- cavo USB-C incluso
- IP66



L
mm 460 € 132,50 1 018370060

1837RB-F/USB

batteria di ricambio per 1837F/USB

1837RB-F/USB € 39,00 1 018370960

1838POCKET

Lampada tascabile snodata, a LED, orientabile, con doppio fascio luminoso, ricaricabile con **ricarica wireless**

- doppia emissione luminosa:
- luce principale: LED COB, 3 intensità luminose: 160 - 400 - 800 Lumen
- luce spot: LED SMD, 250 lumen
- angolo illuminante:
- luce principale: 160°
- luce spot: 18°
- batteria ricaricabile 3.7V 2600mAh Li-ion
- 2 modalità di ricarica:
- base wireless 1839BRW
- alimentatore con attacco USB-C
- tempo di ricarica:
- 4.5 h con base ricarica wireless
- 4 h con alimentatore
- autonomia:
- luce principale: 3-9h
- luce spot: 4.5 h
- Indicatore livello di batteria a 3 led
- orientabile a 210°
- corpo in gomma antiscivolo
- base magnetica
- 1 magnete sulla base
- IP65
- IK07
- cavo USB-C incluso



L I S
mm mm mm 98 82 39 € 70,50 1 018380080

1837C

faretti ricaricabili a LED da cantiere

- 3 intensità luminose
- carica batterie:
- input: 100-240V AC - 50/60Hz;
- output: 15V 1.5A
- tempo di ricarica: 4 ore
- indicatore di carica a 3 LED
- orientabile a 180°
- IP65
- IK07



LxHxI mm	Lm	h	€	1	018370210
220x225x70	2100	2.5	197,00	1	018370210
	1000	5.0			
	500	9.0			
266x236.6x59	4300	1.5	289,00	1	018370430
	2100	3.0			
	1100	6.0			

1837C/RA2100-4300

Alimentatore faretti LED 1837C/2100-4300

100V-240V AC/DC 15V 1.5A

1837C/RA2100-4300 € 28,00 1 018370970

1837M

faretto ricaricabile a LED **COLOUR MATCH**, per controllo colore, elevato indice di resa cromatica (**CRI 96+**), fino a **2.000 Lumen**

- 3 intensità luminose: 500/1.000/2.000Lumen
- CRI (indice di resa cromatica): 96+
- CCT (temperatura colore): 2700K/ 3500K/ 4500K/ 5500K/ 6500K
- carica batterie: input: 100-240V AC - 50/60Hz; output: 15V 1.5A
- connettore di ricarica a sgancio rapido
- tempo di ricarica: 3.5 ore
- durata: 8/4/2 h
- indicatore di carica
- pulsante e led indicatore di temperatura colore
- pulsante e led indicatore di intensità luminosa
- orientabile a 180°
- IP65
- IK07



LxHxI mm	Lm	h	€	1	018370450
220x225x70	500	8.0	308,00	1	018370450
	1000	4.0			
	2000	2.0			

1837M/RA

Alimentatore faretti COLOUR MATCH 1837M

110V-240V AC/DC 15V 1.5A
Lunghezza cavo 5m
Con caricatore a sgancio rapido

1837M/RA € 53,00 1 018370975

1837S

treppiede telescopico per supporto faretto da cantiere

- in metallo
- altezza variabile 70÷170 cm
- compatibile con 1837C, 1838FLASH e 1837M



h
cm 70÷170 € 64,00 1 018370500

1838FLASH

faretto ricaricabile ultracompatto, studiato per offrire la migliore soluzione possibile in ogni utilizzo.

ILLUMINAZIONE ABBONDANTE E SEMPRE PRONTA: con una capacità illuminante massima di 720 lumen e la possibilità di lavorare a batteria o a cavo è sempre pronto all'uso

POSIZIONABILE OVUNQUE:

-su piani: grazie ai piedini di gomma e all'attacco da 1/4" per cavalletto (attacco standard tipo macchina fotografica)

-su strutture metalliche: grazie al magnete svitabile e al gancio orientabile a 360°

COMPATTO: con soli 85x100x155 mm di ingombro può essere comodamente alloggiato nella borsa degli attrezzi ed utilizzato anche in spazi ristretti.

ROBUSTO: studiato per resistere alle sollecitazioni meccaniche più severe.

- 720 Lumen



IP65

1838FLASH € 349,00 1 018380300

1838RB/FLASH

batteria di ricambio per 1838FLASH

1838RB/FLASH € 76,00 1 018380930

1838/11LED

lampada ricaricabile con LED ad altissima luminosità

batteria ai polimeri di litio

- corpo compatto in gomma antiscivolo
- vetrino frontale facilmente sostituibile
- gancio orientabile
- con stazione di ricarica 110-230Vac
- 320 Lumen
- con led in testa per illuminazione multidirezionale
- tempo di ricarica: 6h
- autonomia: 4h 40min



1838/11LED € 171,00 1 018380111

1838RA/10-11LED

alimentatori di ricambio per 1838/10LED e 1838/11LED

CE

1838RA/10-11LED € 36,00 1 018380903

1838RB/10LED

batteria di ricambio per 1838/10LED e 1838/11LED

1838RB/10LED € 57,50 1 018380902

1838RR/11LED

basi di ricarica per 1838/11LED

1838RR/11LED € 38,00 1 018380914

1838RV/11LED

vetrino paragraffi di ricambio per lampada 1838/11LED



1838RV/11LED € 5,25 2 018380905

1838AM

lampada da ispezione ricaricabile a LED, con doppia emissione luminosa, snodata e orientabile a 180°, con base magnetica e gancio orientabili

- 2 emissioni luminose:
 - frontale: LED COB, 60-700 lumen, regolabile con potenziometro
 - spot (testa): LED SMD, 120 lumen, interruttore ON-OFF
- batteria ricaricabile 3.6V 2600mAh Li-ion
- con attacco USB-C
- fornita con caricatore 100-240V / 50-60Hz
- tempo di ricarica: 4h
- autonomia:
 - frontale: 2.5-16h
 - spot (testa): 10h
- indicatore livello di batteria a 3 led

- snodata e orientabile a 180° (± 90° rispetto all'asse)
- base magnetica (con magneti al neodimio) orientabile a 90°
- gancio orientabile alla base

- IP54
- IK07



L I S L1
mm mm mm mm
1838AM 405 40 45 175 € 112,00 1 018380400

1838COB

lampada a LED portatile ricaricabile

- appendibile, con corpo in gomma antiscivolo e antiurto
- batteria ai polimeri di Litio
- Gancio orientabile
- Base magnetica orientabile a 180 gradi
- Con caricatore 100-240Vac / 50-60Hz
- 100/200 lumen; SPOT 75 lumen
- Autonomia: 6h / 3h; SPOT 4h
- tempo di ricarica: 3 ore
- IP65

CE
IP65



1838COB € 97,00 1 018380010

1838P

lampada ricaricabile a penna, con doppia emissione luminosa: a lampada o a torcia

- Corpo compatto in gomma antiscivolo
- 75/150 Lumen
- Gancio da taschino
- Base magnetica orientabile a 180 gradi
- Fornita con cavo di ricarica USB/jack 3.5mm
- Autonomia: 2-4 ore
- IP65



1838P € 83,00 1 018380005

1838SLIM

lampada sottile a 3 LED snodata ricaricabile

- 3 emissioni luminose
- frontale: 100/200 lumen/ posteriore: 180 lumen/ spot (testa): 80 lumen
- base magnetica
- tempo di ricarica: 2.5h
- autonomia: 2-4h/ spot 3h
- cavo USB-C incluso



L I S
mm mm mm
1838SLIM 307 17 29 € 75,50 1 018380221

Beta

Beta

1838SW

lampada snodata a LED,
con ricarica wireless

- doppia emissione luminosa:
frontale: LED COB, 3 intensità luminose: 250 - 500 - 1000 Lumen
spot (testa): LED SMD, 200 lumen
- batteria ricaricabile 3.6V 3.350mAh Li-ion
- 2 modalità di ricarica:
base wireless 1839BRW
alimentatore con attacco USB-C
- tempo di ricarica:
6.5h con base ricarica wireless
4.5h con alimentatore
- autonomia:
frontale: 3-5h
spot (testa): 7h
- Indicatore livello di batteria a 3 led
- base orientabile a 180°
- corpo in gomma antiscivolo
- doppio gancio orientabile
- 3 magneti sul retro
- 1 magnete sulla base
- IP65
- IK07
- cavo USB-C incluso



	L	I	S	€	1	018380142
	mm	mm	mm			
1838SW	260	53	40	100,50		

1838UV

lampada ricaricabile UV + luce bianca
ideale per la ricerca di perdite

- Corpo compatto in gomma antiscivolo
- Con caricatore 100-240Vac / 50-60Hz
- 150 lumen / UV

DISPONIBILE FINO AD ESAURIMENTO SCORTE



	L	I	S	€	1	018380150
	mm	mm	mm			
1838UV				163,50		

1838E

lampada sottocofano ricaricabile a LED

- 3 intensità luminose: 500/1000/2000 lumen
- orientabile a 360°
- lunghezza variabile: 116 ÷ 188 cm
- corpo in alluminio
- ganci in gomma antiscivolo
- ricarica con attacco USB-C
- 2 modalità di ricarica:
ricarica tramite presa USB della lampada
ricarica tramite presa USB della batteria interna
- fornita con caricabatterie
- input: 100-240V ~ 50/60Hz
output: DC 5V - 2000 mA
- autonomia: 3-9 h
- batteria inclusa
- IP20
- IK07

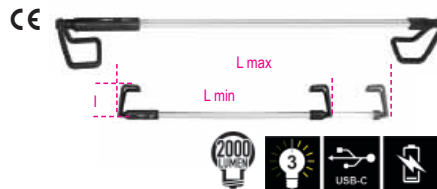

IP20
IK07

L min	L max	I	€	1	018380270
mm	mm	mm			
1170	1880	150	191,50		

1838E-BT

batteria ricaricabile con attacco USB-C per
lampada sottocofano 1838E

- Li-Ion 3,6V
- DC 5V - 2000 mA

CE

	€	1	018380271
1838E-BT	54,00		

1839BRW

base di ricarica wireless,
compatibile con lampade 1838POCKET,
1838SW, 1836AW

- due posizioni di ricarica con attacco magnetico utilizzabili contemporaneamente
- con supporto estraibile per ricarica wireless telefono cellulare
- led per indicare lo stato di ricarica
- max input 10W x2
- input: AC 100-240V 50/60Hz
- output:
DC 12V 1.5A
DC 9V 2A
DC 5V 3A
- cavo QC3.0 USB-C (Fast charger)
- caricatore QC3.0 USB-C (Fast charger)
- appendibile a parete tramite:
3 forti magneti sul retro
2 fori per viti
- IP20
- IK07



	L	I	S	€	1	018390002
	mm	mm	mm			
1839BRW	101	190	28	95,00		

1839/R5

cavo USB-C QC 3.0, ricambio per
1838POCKET, 1838SW, 1839BRW, 1836AW

	€	1	018390505
1839/R5	8,65		

1839/R6

trasformatore quick charge USB Q C3.0,
ricambio per 1838POCKET, 1838SW,
1839BRW, 1836AW

	€	1	018390506
1839/R6	25,50		

1839/R1

trasformatore con uscita USB, ricambio per
1833L/USB, 1836B, 1837F/USB, 1838COB,
1838P, 1838SLIM, 1838UV, 1838AM, 1838E

IN: 100-240Vac / 50-60Hz
USB OUT: 5Vdc / 1A

CE

	€	1	018390501
1839/R1	24,90		

1839/R2

cavo USB/jack 3.5mm, ricambio per 1836B,
1838P, 1838COB, 1838UV

	€	1	018390502
1839/R2	9,60		

1839/R4

cavo USB/USB-C, ricambio per 1833L/USB,
1837F/USB, 1838SLIM, 1838AM, 1838E

	€	1	018390504
1839/R4	8,50		

Beta

Beta

1842LED/BM

lampada con LED ad altissima luminosità, 100- 240 Vac

- cavo da 10 m
- corpo compatto in gomma antiscivolo
- vetrino frontale facilmente sostituibile
- gancio orientabile
- 340 Lumen
- con LED in testa per illuminazione multidirezionale



CE IP65
L mm 230 € 141,50 1 018420301

1842LED/ABM

lampada con LED ad altissima luminosità, 12-24 V AC/DC

- cavo da 10 m
- corpo compatto in gomma antiscivolo
- vetrino frontale facilmente sostituibile
- gancio orientabile
- 340 Lumen
- con LED in testa per illuminazione multidirezionale



CE IP65
L mm 230 € 134,00 1 018420311

AVVOLGITORI



La nuova gamma di arrotolatori, progettata e sviluppata da Beta, offre un programma ampio e completo, atto a soddisfare le esigenze di tutti i professionisti.

- la gamma avvolgicavi comprende un'ampia proposta di metrature e tipologie di cavo, versioni con lampada LED e con presa e spina SCHUKO.
- la gamma avvolgitubo comprende tubi da 8 e 10 mm di diametro.

La molla ad alta resistenza assicura una estrema durata nel tempo e la massima fluidità di utilizzo.

Scocche realizzate in polipropilene ad alto spessore per una elevata resistenza agli urti. Il dispositivo a cremagliera permette di bloccare il riavvolgimento automatico del cavo ed è facilmente disinseribile per permettere di lavorare in trazione continua.

Tutti gli arrotolatori sono forniti di una staffa orientabile di 180° per il fissaggio a muro e di una seconda staffa per l'aggancio/sgancio rapido al supporto a parete.

AVVOLGICAVI

Ampia proposta di ben 18 versioni per soddisfare qualunque necessità lavorativa anche dell'utente più esigente. Lunghezze disponibili da 10 a 30 metri con sezioni da 2x1,0 mm² a 5Gx1,5mm² e con tipologie di cavo H05VV-F e H07RN-F. Tutti gli avvolgicavi, fino ad una sezione del cavo di 3Gx2,5mm², sono forniti di protezione termica che entra in funzione in caso di sovraccarico del circuito elettrico.



AVVOLGITUBI  pag. 347

Una gamma selezionata, con lunghezze disponibili da 10 a 15 metri con diametro da 8 e da 10 mm, per utilizzo con utensili pneumatici.

I nostri prodotti, grazie ad una tenuta senza perdite, possono essere utilizzati anche con acqua.

Art.	Art. Beta	Conduttori	Sezione	Tipo cavo	Lungh.	Scocca	Protez.	Accessorio
1842 15-H05/LED	018420821	2x	1,0 mm ²	H05VV-F	15+1 m	Piccola	SI	Lampada LED
1843 15-H05	018430215	2x	1,5 mm ²	H05VV-F	15+1 m	Piccola	SI	
1844 10-H05	018440310	3G	1,5 mm ²	H05VV-F	10+1 m	Piccola	SI	-
1844 15-H05	018440315			H05VV-F	15+1 m	Piccola	SI	-
1844 15-H07	018440317			H07RN-F	14+1 m	Piccola	SI	-
1844 30-H05	018440330			H05VV-F	30+2 m	Grande	SI	-
1844 15-H05/SCK	018440316	3G	1,5 mm ²	H05VV-F	15+1 m	Piccola	SI	SCHUKO
1844 15-H07/SCK	018440318			H07RN-F	14+1 m	Piccola	SI	SCHUKO
1845 12-H05	018450365	3G	2,5 mm ²	H05VV-F	12+1 m	Piccola	SI	
1845 15-H07	018450367			H07RN-F	15+1 m	Grande	SI	
1845 25-H07	018450377			H07RN-F	25+1,5 m	Grande	SI	
1846 10-H05	018460405	4G	1,5 mm ²	H05VV-F	10+1 m	Piccola	NO	
1846 10-H07	018460407			H07RN-F	10+1 m	Piccola	NO	
1846 15-H05	018460415			H05VV-F	15+1 m	Piccola	NO	
1847 10-H05	018470420	4G	2,5 mm ²	H05VV-F	10+1 m	Grande	NO	
1847 15-H07	018470427			H07RN-F	15+1 m	Grande	NO	
1848 10-H05	018480510	5G	1,5 mm ²	H05VV-F	10+1 m	Grande	NO	
1848 15-H07	018480517			H07RN-F	15+1 m	Grande	NO	



1842

avvolgitore automatico completo di lampada a LED, 100-240Vac

- con trasformatore di sicurezza 230/12V
- cavo H05VV-F 2x1,0 mm²
- 15 m di cavo arrotolato
- cavo in entrata da 1,5 m con spina SCHUKO
- lunghezza cavo fuori scocca 1 m
- cremagliera disinseribile per cavo sempre in trazione
- fornito con staffa orientabile di 180° e seconda staffa ad incastro rapido

CE



IP42
IP65

L=15 m

Model	Cable	L (m)	Price (€)	Qty	Code
1842 15-H05/LED	H05VV-F	15+1	353,00	1	018420821

1846R-LED/BM

lampade di ricambio a LED

12-24V - AC-DC



Model	Price (€)	Qty	Code
1846LED/BM R	97,00	1	018460331

1843

avvolgitore automatico con cavo 2x1,5 mm²

- cavo H05VV-F 2x1,5 mm²
- con protettore termico
- 15 m di cavo arrotolato
- lunghezza cavo fuori scocca 1 m
- fornito senza cavo in entrata
- cremagliera disinseribile per cavo sempre in trazione
- potenza max. arrotolata 1300W (230V-20°C)
- potenza max. srotolata 2300W (230V-20°C)
- fornito con staffa orientabile di 180° e seconda staffa ad incastro rapido

CE



IP42

Model	Cable	L (m)	Price (€)	Qty	Code
1843 15-H05	H05VV-F	15+1	235,50	1	018430215

1844

avvolgitore automatico con cavo 3Gx1,5 mm²

- cavo 3Gx1,5 mm²
- con protettore termico
- lunghezza cavo fuori scocca 1 m (tranne 1844 30-H05 con 2 m)
- fornito senza cavo in entrata
- cremagliera disinseribile per cavo sempre in trazione
- potenza max. arrotolata 1500W (230V-20°C)
- potenza max. srotolata 2500W (230V-20°C)
- fornito con staffa orientabile di 180° e seconda staffa ad incastro rapido

CE



IP42

Model	Cable	L (m)	Price (€)	Qty	Code
1844 10-H05	H05VV-F	10+1	210,00	1	018440310
1844 15-H05	H05VV-F	15+1	230,00	1	018440315
1844 15-H07	H07RN-F	14+1	250,00	1	018440317
1844 30-H05	H05VV-F	30+2	442,00	1	018440330

1844SCK

avvolgitore automatico con cavo 3Gx1,5 mm² con presa SCHUKO

- cavo 3Gx1,5 mm²
- con protettore termico
- lunghezza cavo fuori scocca 1 m
- fornito con cavo in entrata da 1,5 m e spina SCHUKO
- cremagliera disinseribile per cavo sempre in trazione
- potenza max. arrotolata 1500W (230V-20°C)
- potenza max. srotolata 2500W (230V-20°C)
- fornito con staffa orientabile di 180° e seconda staffa ad incastro rapido

CE



IP42

Model	Cable	L (m)	Price (€)	Qty	Code
1844 15-H05/SCK	H05VV-F	15+1	240,00	1	018440316
1844 15-H07/SCK	H07RN-F	14+1	260,00	1	018440318

1845

avvolgitore automatico con cavo 3Gx2,5 mm²

- cavo 3Gx2,5 mm²
- con protettore termico
- lunghezza cavo fuori scocca 1 m (tranne 1845 25-H07RN-F con 1,5 m)
- fornito senza cavo in entrata
- cremagliera disinseribile per cavo sempre in trazione
- potenza max. arrotolata 2000W (230V-20°C)
- potenza max. srotolata 3000W (230V-20°C)
- fornito con staffa orientabile di 180° e seconda staffa ad incastro rapido

CE



IP42

Model	Cable	L (m)	Price (€)	Qty	Code
1845 12-H05	H05VV-F	12+1	474,00	1	018450365
1845 15-H07	H07RN-F	15+1	474,00	1	018450367
1845 25-H07	H07RN-F	25+1,5	598,00	1	018450377

1846

avvolgitore automatico con cavo 4Gx1,5 mm²

- cavo 4Gx1,5 mm²
- senza protettore termico
- lunghezza cavo fuori scocca 1 m
- fornito senza cavo in entrata
- cremagliera disinseribile per cavo sempre in trazione
- potenza max. arrotolata 1400W (400V-20°C)
- potenza max. srotolata 1900W (400V-20°C)
- fornito con staffa orientabile di 180° e seconda staffa ad incastro rapido

CE



IP42

Model	Cable	L (m)	Price (€)	Qty	Code
1846 10-H05	H05VV-F	10+1	255,00	1	018460405
1846 10-H07	H07RN-F	10+1	264,00	1	018460407
1846 15-H05	H05VV-F	15+1	264,00	1	018460415



1847

avvolgitore automatico con cavo 4Gx2,5 mm²

- cavo 4Gx2,5 mm²
- senza protettore termico
- lunghezza cavo fuori scocca 1 m
- fornito senza cavo in entrata
- cremagliera disinseribile per cavo sempre in trazione
- potenza max. arrotolata 2000W (400V-20°C)
- potenza max. srotolata 2700W (400V-20°C)
- fornito con staffa orientabile di 180° e seconda staffa ad incastro rapido

CE



IP42



Model	Cable	L (m)	Price (€)	Weight (kg)	Code
1847 10-H05	H05VV-F	10+1	274,00	1	018470420
1847 15-H07	H07RN-F	15+1	510,00	1	018470427

1848

avvolgitore automatico con cavo 5Gx1,5 mm²

- cavo 5Gx1,5 mm²
- senza protettore termico
- lunghezza cavo fuori scocca 1 m
- fornito senza cavo in entrata
- cremagliera disinseribile per cavo sempre in trazione
- potenza max. arrotolata 1400W (400V-20°C)
- potenza max. srotolata 1900W (400V-20°C)
- fornito con staffa orientabile di 180° e seconda staffa ad incastro rapido

CE



IP42



Model	Cable	L (m)	Price (€)	Weight (kg)	Code
1848 10-H05	H05VV-F	10+1	285,00	1	018480510
1848 15-H07	H07RN-F	15+1	544,00	1	018480517

1852R1750

riscaldatore ad induzione portatile



CE

Riscalda e sblocca bulloni, dadi, mozzi e cuscinetti particolarmente bloccati senza l'utilizzo di fiamme. Permette di scaldare qualsiasi tipo di metallo ferromagnetico.

Vantaggi:

- Risparmio di tempo: riscaldamento veloce e con grande precisione
- Sicurezza anti incendio: non genera fiamme, massima sicurezza per l'operatore
- Praticità: utilizzabile con una sola mano e serpentine facilmente intercambiabili

Dotazione:

- Due serpentine frontali con diametro 19 e 26 mm per sblocco dadi
- Una serpentina piatta per scaldare le superfici
- Una serpentina flessibile lunga 800 mm
- Fornito in valigetta di plastica

Dati tecnici:

- Tensione di ingresso: 230V AC, 50/60 Hz
- Corrente di ingresso: max. 7,5A
- Potenza: max. 1.75 kW

Campi di applicazione:

- Automotive
- Manutenzione industriale
- Industria aeronautica
- Industria navale
- Industria petrolchimica

1852R1750	1.580,00	1	018520175
-----------	----------	---	-----------

480x370x130 mm - 4,5 kg

1852S-CNT

serpentina a contatto



1852S-CNT	118,50	1	018520520
-----------	--------	---	-----------

1852S-CC

serpentina a cucchiaio



1852S-CC	95,00	1	018520521
----------	-------	---	-----------

1852S-KR/CNT

kit ricambi per serpentina a contatto



1852S-KR/CNT	51,50	1	018520522
--------------	-------	---	-----------

1852S-L

serpentine laterali



Model	Ø (mm)	M	L (mm)	Price (€)	Weight (kg)	Code
1852S-L 19	19	M6	220	48,00	1	018520501
1852S-L 20	20	M8	220	48,00	1	018520502
1852S-L 23	23	M10	220	48,00	1	018520503
1852S-L 26	26	M12	220	48,00	1	018520504
1852S-L 32	32	M16	220	48,00	1	018520505
1852S-L 38	38	M20	220	55,00	1	018520506
1852S-L 45	45	M22	220	60,50	1	018520507

1852S-F

serpentina frontale



Model	Ø (mm)	M	L (mm)	Price (€)	Weight (kg)	Code
1852S-F 19	19	M6	220	48,00	1	018520508
1852S-F 20	20	M8	220	48,00	1	018520509
1852S-F 23	23	M10	220	48,00	1	018520510
1852S-F 26	26	M12	220	48,00	1	018520511
1852S-F 32	32	M16	220	48,00	1	018520512
1852S-F 38	38	M20	220	55,00	1	018520513
1852S-F 45	45	M22	220	58,50	1	018520514

1852S-FLESS

serpentina flessibile



Model	L (mm)	Price (€)	Weight (kg)	Code
1852S-FL750	750	35,50	1	018520519
1852S-FLESS	800	90,00	1	018520515
1852S-FL1000	1000	115,50	1	018520517
1852S-FL1500	1500	136,50	1	018520518

- serpentina 1852S-FL 750 semi rigida

1852 S-PIATTE

serpentina piatta

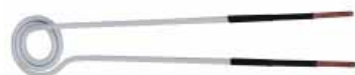

1852S-PIATTE	55,00	1	018520516
--------------	-------	---	-----------

Beta

Beta
Quality Tools



SALDATURA



SALDATRICI A INVERTER

Saldatrici a inverter facili da utilizzare, ottime caratteristiche di saldatura con tutti i tipi di elettrodi. Dotate di controllo di sovratensione, sovratemperatura e antincollaggio dell'elettrodo. Sono compatte e leggere, ideali per lavori di manutenzione domestica, carpenteria leggera e lavori di manutenzione.



MASCHERE PER SALDARE

Beta offre varie maschere LCD ad oscuramento automatico adatte a differenti tipi di saldatura: ad elettrodo, MIG/MAG, TIG e plasma. Protezione e comfort vengono garantite dalla piena conformità a tutte le normative di sicurezza vigenti.



ACCESSORI PER LA SALDATURA

Ampia gamma di accessori per supportare le operazioni legate ai lavori di saldatura.



SALDATRICI PER STAGNO E A GAS

Saldatrici e accessori studiati per le piccole manutenzioni e lavorazioni nell'ambito della microelettronica. Oltre alle saldatrici alimentate via cavo, Beta offre varie soluzioni a gas butano che consentono anche lavorazioni in ambiente outdoor e in assenza di elettricità.

1808

saldatore a doppia potenza
con punta acciata 1824 R08



W	V	€	Icon	Icon
20/130	230	87,00	1	018080001

1812 150

saldatore istantaneo



W	V	€	Icon	Icon
150	230	124,50	1	018120015

1814M

saldatori a stilo
con punta acciata



W	V	€	Icon	Icon
25	230	70,00	1	018140225
30	230	73,50	1	018140230
40	230	80,00	1	018140240

1820

saldatori a stilo



Model	W	V	€	Icon	Icon
1820 30	30W		51,50	1	018200003
1820 60	60W		59,00	1	018200006
1820 80	80W		83,50	1	018200008

1822

saldatori a martello



Model	W	V	€	Icon	Icon
1822 120	120W		127,50	1	018220012
1822 180	180W		135,00	1	018220018
1822 320	320W		168,00	1	018220032

1823 60

stazione di saldatura
a controllo digitale
fornita con saldatore

- Regolazione continua della temperatura da 160°C a 480°C con precisione ±1%.
- Funzione di memoria per salvataggio temperatura selezionata al momento dello spegnimento.
- 3 tasti di selezione rapida (200-300-400°C).



W	€	Icon	Icon
60	494,00	1	018230060

1823R/60

saldatore di ricambio per 1823 60



Model	W	€	Icon	Icon
1823R 60	60W	97,50	1	018230066



1824R

punte di ricambio
per saldatori

Model	W	V	€	Icon	Icon
1824R 08			37,00	1	018240100
1824R 12			5,00	1	018240301
1824R 14-M25			5,00	1	018240152
1824R 14-M30			5,00	1	018240153
1824R 14-M40			5,00	1	018240154
1824R 20			6,60	1	018240302
1824R 60			6,60	1	018240303
1824R 80			9,55	1	018240304
1824R 120-180			77,50	1	018240305
1824R 320			98,50	1	018240307
1824R ST-60			13,60	1	018240308

1825B

filo per saldatura a stagno con antiossidante

- filo da 1mm²; 250g
- Sn 99.3%; Cu 0.7%



Model	€	Icon	Icon
1825B	72,50	1	018250251

1827

saldatore a gas regolabile



Model	€	Icon	Icon
1827	156,00	1	018270001

1827PC

punte di ricambio coniche per 1827



Model	€	Icon	Icon
1827PC 1,6	32,50	1	018270501
1827PC 3,2	32,50	1	018270502

1827PCL

punta di ricambio a coltello per 1827



Model	€	Icon	Icon
1827PCL 2,4	32,50	1	018270503

1827PFL

punte di ricambio a fiamma libera per 1827



1827PFL € 32,50 1 018270504

1827/K

saldatore a gas con 7 accessori in valigetta con base morbida di polietilene espanso



Caratteristiche:

- Potenza: da 30 Watt a 125 Watt
- Temperatura della punta regolabile da 250°C a 500°C
- Regolatore del flusso di gas
- Tempo di riscaldamento 15 secondi dopo l'accensione
- Il serbatoio contiene gas per 120 minuti di utilizzo continuato
- Serbatoio trasparente per monitorare il livello di gas
- Ricaricabile con gas butano

1827/K € 241,50 1 018270100

1827F

saldatore a gas butano ricaricabile

maxiserbatoio da 35g

- tre ugelli intercambiabili da 550°C; 1000°C e 1300°C
- fornito con cavalletto in valigetta rigida



1827F € 171,50 1 018270200

1830T

pompetta per dissaldare con ugello antistatico in materiale plastico (PTFE)



L mm 190 € 18,40 5 018300021

1860BH/120A

saldatrice a inverter con uscita corrente continua (DC) per saldature MMA con elettrodi rutili, basici e inox.
compatta e facile da trasportare

funzioni arcforce, hotstart, anti-sticking, protezione termostatica

corrente di regolazione: 10÷120A
alimentazione: 1x230V

fattore di utilizzo (40°C) :
25% - 120 A
50% - 80 A
100% - 60 A
protezione: IP22S
elettrodi utilizzabili: Ø 1.6 - 3.2mm rutilici, basici, inox, ecc.

CE



1860BH/120A € 381,00 1 018600121

1860BH/160A

saldatrice a inverter con uscita corrente continua (DC) per saldature MMA con elettrodi rutili, basici e inox.
compatta e facile da trasportare

funzioni arcforce, hotstart, anti-sticking, protezione termostatica

corrente di regolazione: 10÷160A
alimentazione: 1x230V

fattore di utilizzo (40°C) :
25% - 160 A
60% - 100 A
100% - 80 A
protezione: IP22S
elettrodi utilizzabili: Ø 1.6 - 4mm rutilici, basici, inox, ecc.

CE



1860BH/160A € 491,00 1 018600161

1860BH/200A

saldatrice a inverter con uscita corrente continua (DC) per saldature MMA con elettrodi rutili, basici e inox.
compatta e facile da trasportare

funzioni arcforce, hotstart, anti-sticking, protezione termostatica

corrente di regolazione: 10÷200A
alimentazione: 1x230V

fattore di utilizzo (40°C) :
25% - 200 A
60% - 130 A
100% - 100 A
protezione: IP22S
elettrodi utilizzabili: Ø 1.6 - 4mm rutilici, basici, inox, ecc.

CE



1860BH/200A € 546,00 1 018600201

1860BH R/CM

cavi massa di ricambio per saldatrici a inverter 1860BH-120/160/200A



1860BH R/CM € 52,50 1 018600612

1860BH R/CS

cavi pinza porta elettrodo di ricambio per saldatrici a inverter 1860BH-120/160/200A



1860BH R/CS € 64,00 1 018600613

1860BHT/160A

saldatrice a inverter con uscita corrente continua (DC) per saldature ad elettrodo MMA e TIG su acciaio.

compatta e facile da trasportare

funzioni arcforce, STICK/TIG (lift arc), hotstart, anti-sticking, protezione termostatica

corrente di regolazione: 10÷160A
alimentazione: 1x230V

fattore di utilizzo (40°C):

35% - 160 A

60% - 130 A

100% - 95 A

protezione: IP23S

elettrodi utilizzabili: Ø 1,6 - 4mm rutilici, basici, inox.

fornito con cavi da 25mm²

CE



1860BHT/160A € 956,00 1 018600179

1860BHT R/CM

cavi massa di ricambio per saldatrici TIG 1860BHT



1860BHT R/CM € 81,50 1 018600616

1860BHT R/CS

cavi pinza saldatura di ricambio per saldatrici TIG 1860BHT



1860BHT R/CS € 105,00 1 018600617

1860BHT/T

torce TIG per saldatrici TIG 1860BHT
• Lunghezza: 4m • Connettore: 50mm²



1860BHT/T € 259,00 1 018600615

1860M

morse angolari magnetiche per saldatura con regolazione rapida con ganascia oscillante ideale per bloccare particolari di differenti dimensioni



1860M L max mm 30 € 98,00 1 018600301

1860DM

dischi magnetici sollevamchiere

ideale per movimentare e fissare lamiere forza magnetica costante su tutta la superficie del disco manici dotati di foro per facilitare le lavorazioni in verticale



1860DM 16 kg max 16 € 56,00 1 018600310
1860DM 40 kg max 40 € 79,00 1 018600311

1860PMIG

pinze multiuso per saldatura MIG



1860PMIG L mm 215 L1 mm 44 € 40,50 2 018600350

1860EI

squadra magnetica 90°, per angoli interni ed esterni. ideale per bloccare particolari tubolari o piatti 18Kg di forza magnetica con smussi per angoli da 30 e 60° con foro esagonale per facilitare il distacco del magnete dal metallo



1860EI L mm 165 L1 mm 110 S mm 35 € 39,50 1 018600290

1860RG

squadra magnetica regolabile 30°÷270°

ideale per bloccare particolari tubolari o piatti 15Kg di forza magnetica chiave esagonale in dotazione per bloccaggio regolazione angolo perno in dotazione per bloccaggio regolazione a 30°-45°-90°/270°-180° con foro esagonale per facilitare il distacco del magnete dal metallo



1860RG L mm 155 S mm 35 € 63,50 1 018600255

1860SQ

squadra magnetica 45°/90°

ideale per bloccare particolari tubolari o piatti 25Kg di forza magnetica non necessita batteria, effetto ON/OFF ottenuto con l'inclinazione dei magneti interni pulizia da trucioli agevolata coi magneti in posizione OFF



1860SQ € 96,50 1 018600210





7041LCD/4S

maschera LCD ad oscuramento automatico, per saldatura ad elettrodo; MIG/MAG; TIG e plasma.

4 sensori con filtro TRUE COLOR

alimentazione a celle solari e batterie al litio per una durata eccezionale del filtro LCD

- area di visuale 98x80 mm
- classe ottica: 1/1/1/2
- tonalità di oscuramento variabile 5+8,5/ 9-13 con regolazione interna
- protezione UV/IR: DIN16
- tempo d'oscuramento 1/25000 s
- tempo di rischiaramento 0.1-2.0s
- sensibilità e ritardo dell'oscuramento regolabili
- accensione e spegnimento automatici
- funzione di smerigliatura
- indicatore livello basso batteria
- design ergonomico, leggera e ben bilanciata
- con ghiera regolabile



7041LCD/4S € 314,00 1 070410001

7041LCD/4S-VE

vetrino paragraffi esterno per 7041LCD/4S

7041LCD/4S-VE € 7,65 2 070410101

7041LCD/4S-VI

vetrino interno per 7041LCD/4S

7041LCD/4S-VI € 3,85 2 070410102

7042LCD

maschera LCD ad oscuramento automatico, per saldatura ad elettrodo; MIG/MAG; TIG e plasma.

alimentazione a celle solari e batterie al litio per una durata eccezionale del filtro LCD

- area di visuale 98x43 mm
- tonalità di oscuramento DIN 9-13 con regolazione esterna
- protezione UV/IR
- tempo d'oscuramento 1/25000 s
- tempo di rischiaramento 0.25-1s
- sensibilità e ritardo dell'oscuramento regolabili
- accensione e spegnimento automatici
- funzione di smerigliatura
- forma ottimizzata per agevolare la respirazione a schermo abbassato



7042LCD € 220,00 1 070420001

7042LCD/RV

vetrino paragraffi esterno per 7042LCD, 7043

7042LCD/RV € 3,45 2 070420101

7042LCD/RV-INT

vetrino interno per 7042LCD, 7043

7042LCD/RV-INT € 3,05 2 070420102

7043

maschera LCD ad oscuramento automatico, per saldatura ad elettrodo, MIG/MAG, TIG e plasma.

alimentazione a celle solari.

- area di visuale 92x43 mm
- tonalità di oscuramento DIN 9-13 con regolazione esterna
- protezione UV/IR
- tempo d'oscuramento 1/1000 s
- tempo di rischiaramento 0.1-1.0 s
- ritardo dell'oscuramento regolabile
- accensione e spegnimento automatici
- funzione di smerigliatura
- forma ottimizzata per agevolare la respirazione a schermo abbassato



7043 € 127,50 1 070430001

AUTORIPARAZIONE

I nostri utensili per autoriparazione, usati dai professionisti più esigenti, sono sviluppati e prodotti per soddisfare gli standard più elevati al mondo e testati continuamente nelle condizioni di utilizzo più stressanti.

Da oltre 50 anni, siamo orgogliosamente a fianco dei più grandi campioni, che ci aiutano a migliorare costantemente i nostri prodotti e ne confermano il livello di qualità più assoluta.

Gli utensili dedicati all'autoriparazione si trovano in queste sezioni:

Diagnostica	da 1438 a 1499 da 1758VT a 1760TMC
Motore	da 955 a 989A da 1438 a 1499
Olio e filtri	da 1438 a 1499 da 1877 a 1885
Impianto elettrico	da 1438 a 1499
Avviatori	da 1498BC/12 a 1498/40A
Trasmissione	da 1438 a 1499
Sospensioni	da 1549 a 1569CP
Freni	da 1438 a 1499
Ruote	da 955 a 989A
Carrozzeria	da 1302 a 1369 da 1763 a 1767A
Altre attrezzature	da 1875LT a 3067
Sollevari	da 3029/2T a 3067/70-13T



1875LT

lavamoquette e lavatappezzeria ad iniezione ed estrazione

Ideale per lavare in profondità superfici in tessuto. Eroga detergente nebulizzato a pressione e lo aspira, unitamente allo sporco. Rivestimenti e tappeti si asciugano rapidamente data la quantità ridottissima di umidità residua dopo la pulizia.

Accessori in dotazione:

- 1 tubo flessibile completo di impugnatura ergonomica
- 1 gruppo erogatore
- 2 prolunghe rigide
- 1 bocchetta spruzzaspira piccola
- 1 bocchetta spruzzaspira grande
- 6 ghiera blocca cavo alimentazione elettrica

CE



1875LT € 602,00 1 018750000

1875SP/K3

kit spazzole per la pulizia dei tessuti

- 1 spazzola piana Ø 48 mm
- 1 spazzola piana Ø 100 mm
- 1 spazzola semisferica Ø 90 mm
- attacco per avvitatore da 1/4"

1/4



ISO 1173 E 6,3

1875SP/K3 € 19,40 1 018750010

1877

recuperatore olio esausto carrellato con serbatoio da 90 l

- indicatore di livello
- coppa di grande diametro con griglia scolafiltro capacità 12 l
- svuotamento pneumatico del serbatoio con tubo da 1,8 m
- vaschetta portautensili

CE



1877 € 749,00 1 018770008

1877A

recuperatore/aspiratore olio esausto, carrellato con serbatoio da 90 l e precamera

- indicatore di livello
- coppa di grande diametro con griglia scolafiltro capacità 12 l
- precamera trasparente capacità 9,5 l
- tubo aspirazione da 1,8 m
- svuotamento pneumatico del serbatoio con tubo da 1,8 m
- vaschetta portautensili

In dotazione:

- 1 sonda rigida Ø 5x700 mm
- 1 sonda flessibile Ø 5x700 mm
- 1 sonda rigida Ø 6x600 mm
- 1 sonda flessibile Ø 6x700 mm
- 1 sonda flessibile Ø 7x700 mm
- 1 sonda flessibile Ø 8x700 mm
- adattatori per VW, BMW, CITROËN

CE



1877A € 1.325,00 1 018770080

1877F

recuperatore olio esausto per flaconi da 1 Litro

Caratteristiche:

- Può accogliere fino a 4 flaconi contemporaneamente
- 2 taniche da 2 l incluse



H mm 405 L mm 270 P mm 240 € 102,00 1 018770100

1877P

recuperatore olio esausto carrellato con serbatoio in polietilene

- capacità serbatoio: 40 l
- ampia coppa in PPL per la raccolta dell'olio
- indicatore di livello
- svuotamento pneumatico del fusto



H min-Max mm 1030-1630 H1 mm 900 l 40 € 456,00 1 018770180

1878 2

vaschetta per recupero liquidi

- capacità massima 2 l
- particolarmente indicata per la sostituzione olio sugli scooter



l 2 H mm 85 € 15,30 1 018780002

1878 3

vaschetta per recupero olio mozzi truck scarico dell'olio con salvagoccia



l 3 € 23,10 1 018780003

1878 4

vaschetta per recupero liquidi trasportabile

- indicata per moto
- capacità massima 4 l
- limita gli schizzi



l 4 H mm 100 € 32,50 1 018780004

1878 8

vaschetta per recupero liquidi

- altezza idonea per moto
- capacità massima 8 l



1878 8 | 8 | H 110 | € 17,30 | 1 018780008

1878 11

vaschetta per recupero liquidi

- capacità Massima 11 l
- tappo scarico liquidi
- paratia interna per evitare la fuoriuscita dei liquidi durante il trasporto



1878 11 | 11 | € 38,50 | 1 018780011

1878 30

vasca per recupero liquidi

- capacità Massima 30 l
- griglia anti schizzi
- dotata di 4 ruote pivotanti



1878 30 | 30 | € 149,50 | 1 018780030

1879

aspiratore liquidi manuale e pneumatico da 9,5 Litri



1879 9,5 | € 323,00 | 1 018790001

1879 6

aspiratore liquidi manuale da 6 litri



1879 6 | € 236,00 | 1 018790000

1879R/K4

kit di 4 tubi di ricambio per aspiratore liquidi 1879



1879R/K4 | € 62,50 | 1 018790504

1879/FUEL

aspiratore liquidi manuale da 6 litri utilizzabile per idrocarburi



1879/FUEL | 6 | € 140,00 | 1 018790010

1880

pompa manuale per fusti olio

- per olio
- non usare con liquidi a base acquosa, solventi acidi, gasolio, benzina e simili
- completa di attacco fusto, tubo telescopico e beccuccio di mandata
- utilizzabile con fusti da 60, 100 e 200 Litri



1880 | gr 240 | € 61,00 | 1 018800001

1880ADB

pompa rotativa per AdBlue®

- 5 litri erogati ogni venti rotazioni
- prolunghe per fusti fino a 1,20 m
- 1 attacco per fusti passo fine
- 1 attacco per fusti passo grosso



1880ADB | € 141,50 | 1 018800101

1881

pompa pneumatica per fusti olio rapporto 3:1

- pressione di lavoro da 6 a 8 bar
- consumo aria 230 l/min
- per olio
- non usare con liquidi a base acquosa, solventi acidi, gasolio, benzina e simili
- completa di attacco fusto e tubo telescopico

CE



1881 | l/min 18 | € 519,00 | 1 018810001

1882N

pistola olio con estremità flessibile e salvagocia automatico

- attacco 1/2"
- portata massima 30 l/min
- pressione massima di esercizio 100 bar
- possibilità di bloccare la leva di erogazione



1882N | € 156,00 | 1 018820110

1883N

contalibri digitale per olio

- attacco 1/2"
- rivestimento in gomma antiurto
- pila 2 x AAA
- portata Max: 0÷30 l/min
- pressione Max: 100 bar (1450 psi)
- viscosità: 8÷2000 mPas
- tolleranza: ±0,5%



1883N | € 220,50 | 1 018830036

1883NC

niplex maschio-maschio 1/2 per unire art. 1882N e 1883N



1883NC € 13,70 1 018830135

1884

attrezzo per l'inserimento di olio nei cambi manuali, automatici e nei differenziali

con 12 adattatori per la connessione diretta



1884 € 513,00 1 018840010

AT-101	FORD
AT-102	UNIVERSAL (Bmw, Honda, Nissan...)
AT-103	VW-AUDI
AT-104	VW-AUDI-PORSCHE
AT-105	VW-AUDI-MINI COOPER
AT-106	MERCEDES
AT-107	DSG
AT-108	VW-AUDI CVT
AT-109	VOLVO
AT-110	TOYOTA-LEXUS
AT-111	SKODA
AT-112	VW Passat/Tiguan <2007

1884/C12

cassetta di 12 adattatori per 1884

• inclusa nel 1884



1884/C12 € 190,00 1 018840100

1884N/C8

kit 8 adattatori per 1884

inclusi nel kit:

- 1 adattatore per Infiniti 7 marce M8x1.0
- 1 adattatore per Honda, Hyundai, Kia 5x8x200 mm
- 1 adattatore per Skoda M18x1.5
- 1 adattatore per Mini M14x1.5
- 1 adattatore per Nissan M10x1.5
- 1 adattatore per Nissan Juke M12x1.25
- 1 adattatore per GM M12x1.75
- 1 adattatore per gruppo VAG 7 marce



1884N/C8 € 124,50 1 018840200

200x145x40 mm - 400 g

1889N

base in acciaio per movimentazione e stoccaggio di 2 fusti da 200 l

- verniciata completamente a caldo a polvere epossidica
- facilmente trasportabile con carrello elevatore a forche o transpallet
- supporto non sovrapponibile

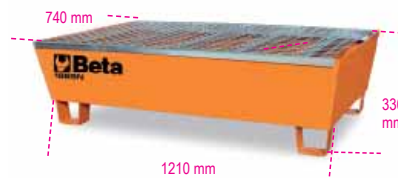

1889N € 853,00 1 018890220

1889CF

chiave universale per apertura fusti

- 1 esagono femmina Ø 38 mm
- 1 profilo a 4 settori Ø 42 mm
- 1 lama 17x7 mm



1889CF € 36,00 1 018890010

1885

stazione per la manutenzione del cambio automatico

Permette di effettuare in totale sicurezza, con una procedura semplice e guidata, l'intero ciclo di lavaggio e sostituzione olio in tutte le trasmissioni automatiche. Previene il danneggiamento derivante dall'usura dell'olio contenuto nel cambio automatico, prevenendo in modo pratico e veloce malfunzionamenti caratteristici come: rumorosità eccessiva del cambio, marce bloccate, bruschi innesti delle marce, allungamento dei tempi di cambiata



Caratteristiche funzionali:

- Funzionamento automatico
- Procedura guidata passo dopo passo con banca dati integrata
- Compensazione della quantità dell'olio immesso garantendo la presenza costante della corretta quantità
- Stampa di ogni operazione effettuata
- Cassetto con adattatori per i cambi più diffusi in modulo morbido

Caratteristiche automatiche:

- Immissione solvente (facoltativo)
- Lavaggio impianto cambio
- Svuotamento olio coppa
- Svuotamento olio convertitore
- Immissione olio convertitore

Caratteristiche tecniche:

- Alimentazione 220 V 50 Hz
- Visori olio retroilluminati con 2 LED luce bianca
- 2 bilance elettroniche
- Bilance elettroniche risoluzione +/- 10g
- Scheda elettronica con display grafico retroilluminato

1885 € 9.070,00 1 018850010



1885/C1

kit raccordi cambio automatico per 1885
(non inclusi in 1885)

il kit include:

- 1885/C1-R1 raccordi cambio Land Rover Freelander
- 1885/C1-R2 raccordo cambio DP0
- 1885/C1-R3 raccordo cambio ZF 9HP
- 1885/C1-R4 asta di livello cambio ZF 9HP
- 1885/C1-R5 asta di livello cambio Mercedes
- 1885/C1-R6 raccordi cambio AISIN TG82
- 1885/C1-R7 raccordi cambio AISIN TG81
- 1885/C1-R8 raccordi cambio Renault-Nissan



1885/C1 € 782,00 1 018850110

1885/C1-R1

raccordi cambio Land Rover Freelander per 1885

Ic01430



1885/C1-R1 € 67,50 1 018850111

1885/C1-R2

raccordo cambio DP0 per 1885

Ic0990



1885/C1-R2 € 117,50 1 018850112

1885/C1-R3

raccordi cambio ZF 9HP per 1885

Ic0992



1885/C1-R3 € 131,50 1 018850113

1885/C1-R4

asta di livello cambio ZF 9HP per 1885

Ic0192



1885/C1-R4 € 73,00 1 018850114

1885/C1-R5

asta di livello cambio Mercedes per 1885

K-A-M



1885/C1-R5 € 121,50 1 018850115

1885/C1-R6

raccordi cambio AISIN TG82 per 1885

Ic01820



1885/C1-R6 € 130,00 1 018850116

1885/C1-R7

raccordi cambio AISIN TG81 per 1885

Ic0150



1885/C1-R7 € 130,00 1 018850117

1885/C1-R8

raccordi cambio Renault-Nissan per 1885

Ic02150



1885/C1-R8 € 130,00 1 018850118

1885/C2

kit raccordi cambio automatico per 1885
(non inclusi in 1885)

il kit include:

- 1885/C2-R1 raccordi cambio Audi 8HP
- 1885/C2-R2 raccordi cambio ZF 9HP senza scambiatore
- 1885/C2-R3 raccordo cambio Audi 0Kc
- 1885/C2-R4 raccordi cambio AG4-ZF 4HP
- 1885/C2-R5 raccordi cambio FIAT
- 1885/C2-R6 raccordi cambio Audi Q5-Q7
- 1885/C2-R7 raccordo Audi cambio 0B5



1885/C2 € 635,00 1 018850120

1885/C2-R1

raccordi cambio Audi 8HP per 1885

Ic0993



1885/C2-R1 € 127,50 1 018850121

1885/C2-R2

raccordi cambio ZF 9HP
senza scambiatore per 1885

Ic0990



1885/C2-R2 € 83,00 1 018850122

1885/C2-R3

raccordo cambio Audi 0Kc per 1885

Ic02020



1885/C2-R3 € 130,00 1 018850123

1885/C2-R4

raccordi cambio AG4-ZF 4HP per 1885

Ic0750



1885/C2-R4 € 112,00 1 018850124

1885/C2-R5

raccordi cambio FIAT per 1885

Ic0061



1885/C2-R5 € 49,00 1 018850125

1885/C2-R6

raccordi cambio Audi Q5-Q7 per 1885

Ic0680



1885/C2-R6 € 121,50 1 018850126

1885/C2-R7

raccordo cambio Audi 0B5 per 1885

Ic01720



1885/C2-R7 € 73,00 1 018850127

1885/C3

kit raccordi cambio automatico per 1885 (non inclusi in 1885)

il kit include:

- 1885/C3-R1 raccordo cambio DSG Mercedes
- 1885/C3-R2 raccordo cambio POWERSHIFT
- 1885/C3-R3 raccordi cambio Toyota IQ
- 1885/C3-R4 raccordi cambio Mazda
- 1885/C3-R5 raccordi cambio Renault Laguna-Esp
- 1885/C3-R6 raccordi cambio Nissan Juke
- 1885/C3-R7 raccordi cambio AISIN TF71 FV
- 1885/C3-R8 raccordi cambio AISIN TF71 FP
- 1885/C3-R9 raccordi cambio AISIN TF71 FO
- 1885/C3-R10 raccordi cambio AISIN TF71 FS



1885/C3 € 1.122,00 1 018850130

1885/C3-R1

raccordo cambio DSG Mercedes per 1885

Ic0191



1885/C3-R1 € 130,00 1 018850131

1885/C3-R2

raccordo cambio POWERSHIFT per 1885

Ic0190



1885/C3-R2 € 130,00 1 018850132

1885/C3-R3

raccordi cambio Toyota IQ per 1885

Ic0991



1885/C3-R3 € 130,00 1 018850133

1885/C3-R4

raccordi cambio Mazda per 1885

Ic02130



1885/C3-R4 € 130,00 1 018850134

1885/C3-R5

raccordi cambio Renault Laguna-Esp per 1885

Ic02150



1885/C3-R5 € 130,00 1 018850135

1885/C3-R6

raccordi cambio Nissan Juke per 1885

Ic02140



1885/C3-R6 € 130,00 1 018850136

1885/C3-R7

raccordi cambio AISIN TF71 FV per 1885

Ic01420



1885/C3-R7 € 130,00 1 018850137

1885/C3-R8

raccordi cambio AISIN TF71 FP per 1885

Ic001420/1



1885/C3-R8 € 130,00 1 018850138

1885/C3-R9

raccordi cambio AISIN TF71 FO per 1885

Ic001420/2



1885/C3-R9 € 130,00 1 018850139

1885/C3-R10

raccordi cambio AISIN TF71 FS per 1885

Ic001420/3



1885/C3-R10 € 130,00 1 018850140

1885/XC60

raccordi cambio Volvo XC60 per 1885



1885/XC60 € 139,50 1 018850151

1893/134A

stazione automatica di ricarica climatizzatori gas R134a

Modello completamente automatico, con banca dati auto/autocarri con quantità gas, quantità e tipo olio compressore, software di autodiagnosi per operazioni di manutenzione ordinaria.

La banca dati è aggiornabile via software. La macchina può operare in modalità manuale (con presidio umano fase per fase) oppure in modalità completamente automatica (senza presidio).



R134A (250 ml)

CARATTERISTICHE FUNZIONALI

- Funzionamento automatico
- Banca dati auto/autocarri con quantità gas, quantità e tipo olio compressore
- Recupero automatico del gas dalla tubazione
- Compensazione della ricarica della quantità di gas contenuto nelle tubazioni
- Scarico automatico dei gas non condensabili
- Segnalazione automatica di anomalie e manutenzione
- Manometri ø 80 mm
- Vacuometro digitale

CARATTERISTICHE TECNICHE

- Serbatoio gas: 15 kg
- Pompa vuoto: 140 l/min
- Bilancia elettronica: 50kg
- Scheda elettronica con display retroilluminato
- Velocità di recupero: 500 g/min
- Alimentazione: 220 V

1893/134A € 6.600,00 1 018930001

1893/1234YF

stazione automatica di ricarica climatizzatori gas R1234yf

Modello completamente automatico, con banca dati auto/autocarri con quantità gas, quantità e tipo olio compressore, software di autodiagnosi per operazioni di manutenzione ordinaria.

La banca dati è aggiornabile via software

La macchina può operare in modalità manuale (con presidio umano fase per fase), oppure in modalità completamente automatica (senza presidio).



CE



1234YF (250 ml)

CARATTERISTICHE FUNZIONALI

Funzionamento automatico
Banca dati auto/autocarri con quantità gas, quantità e tipo olio compressore
Recupero automatico del gas dalla tubazione
Compensazione della ricarica della quantità di gas contenuto nelle tubazioni
Scarico automatico dei gas non condensabili
Segnalazione automatica di anomalie e manutenzione
Manometri \varnothing 80 mm
Vacuometro digitale

CARATTERISTICHE TECNICHE

Serbatoio gas: 15 kg
Pompa vuoto: 140 l/min
Bilancia elettronica: 50 kg
Scheda elettronica con display retroilluminato
Velocità di recupero: 500 g/min
Alimentazione: 220 V

1893/1234YF € 6.810,00 1 018930012

1893TR/134A

traccianti per gas R134a



1893TR/134A ml 250 € 46,00 1 018930901

1893TR/1234YF

traccianti per gas R1234yf



1893TR/1234YF ml 250 € 53,00 1 018930902

1893TR/CI

traccianti per compressori ibridi



1893TR/CI ml 250 € 55,00 1 018930903

1895G

generatore di comando per elettroiniettori (benzina e GPL) ed elettrovalvole

Permette di testare in completa autonomia l'efficienza di componenti come:

- elettrovalvole EGR
- elettroiniettori di motori benzina e GPL
- elettrovalvole regolazione turbina a geometria variabile
- compressori per climatizzatori di nuova generazione



CE

Caratteristiche tecniche

Comando iniettori benzina e GPL

- Numero uscite: 4
- Durata test: 1-60 s
- Tempo apertura: 5-10 ms
- Regolazione frequenza impulso: 1-10 Hz

Comando dispositivi PWM

- Numero uscite: 1
- Durata test: 1-60 min
- Automatico o manuale
- Regolazione duty cycle: 10%-85%
- Regolazione frequenza segnale: 120-250 Hz

1895G € 1.970,00 1 018950800

1895/S

supporto regolabile per vasche ultrasuoni 1895

Permette il corretto posizionamento degli iniettori durante la fase di lavaggio all'interno della vasca ultrasuoni
Compatibile con i modelli di vasche da 6, 13, 27 litri

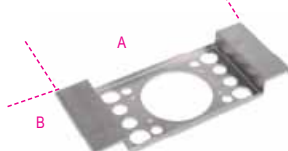

1895S A mm 340 B mm 140 € 116,50 1 018950501

1895 6

vasca di lavaggio ad ultrasuoni da 6 litri

con funzione speciale di degassificazione



CE

Caratteristiche:

- Attraverso il riscaldamento del liquido e con l'azione degli ultrasuoni permette di pulire efficacemente parti di ricambio e pezzi metallici in genere (iniettori, carburatori, valvole, ecc...)
- Display digitale con regolazione della temperatura e del tempo di lavaggio
- Doppia funzione lavaggio: "soft" e "normal"
- Per una pulizia generale è sufficiente usare acqua ad una temperatura di 50/60°C
- Per una pulizia più accurata aggiungere soluzioni detergenti non schiumogene specifiche per vasche ad ultrasuoni
- La funzione degassificazione accelera la liberazione d'aria in tutto il volume della vasca aumentando l'efficacia degli ultrasuoni

Dati tecnici:

- Capacità vasca: 6 litri
- Rubinetto di scarico
- Potenza: 150 Watt
- Potenza di riscaldamento: 300 Watt
- Regolazione temperatura: 0+80°C
- Regolazione tempo di lavaggio: 0-99 minuti
- Frequenza: 40 kHz
- Alimentazione: 220/230V
- Dimensioni: 330x180x310 mm
- Dimensioni serbatoio: 300x155x150 mm
- Dimensioni cestello: 250x105x100 mm
- Portata massima: 5,5 kg

1895 6 Max € 760,00 1 018950060

1895 13

vasca di lavaggio ad ultrasuoni da 13 litri

con funzione speciale di degassificazione



CE

Caratteristiche:

- Attraverso il riscaldamento del liquido e con l'azione degli ultrasuoni permette di pulire efficacemente parti di ricambio e pezzi metallici in genere (iniettori, carburatori, valvole, ecc...)
- Display digitale con regolazione della temperatura e del tempo di lavaggio
- Doppia funzione lavaggio: "soft" e "normal"
- Per una pulizia generale è sufficiente usare acqua ad una temperatura di 50/60°C
- Per una pulizia più accurata aggiungere soluzioni detergenti non schiumogene specifiche per vasche ad ultrasuoni
- La funzione degassificazione accelera la liberazione d'aria in tutto il volume della vasca aumentando l'efficacia degli ultrasuoni

Dati tecnici:

- Capacità vasca: 13 litri
- Rubinetto di scarico
- Potenza: 300 Watt
- Potenza di riscaldamento: 400 Watt
- Regolazione temperatura: 0+80°C
- Regolazione tempo di lavaggio: 0-99 minuti
- Frequenza: 40 kHz
- Alimentazione: 220/230V
- Dimensioni: 350x325x320 mm
- Dimensioni serbatoio: 325x235x145 mm
- Dimensioni cestello: 257x185x100 mm
- Portata massima: 12 kg

1895 13 Max € 1.178,00 1 018950130

1895 27

vasca di lavaggio ad ultrasuoni
da 27 litri
con funzione speciale di degassificazione



CE

Caratteristiche:

- Attraverso il riscaldamento del liquido e con l'azione degli ultrasuoni permette di pulire efficacemente parti di ricambio e pezzi metallici in genere (iniettori, carburatori, valvole, ecc...)
- Display digitale con regolazione della temperatura e del tempo di lavaggio
- Doppia funzione lavaggio: "soft" e "normal"- per una pulizia generale è sufficiente usare acqua ad una temperatura di 50/60°C
- Per una pulizia più accurata aggiungere soluzioni detergenti non schiumogene specifiche per vasche ad ultrasuoni
- La funzione degassificazione accelera la liberazione d'aria in tutto il volume della vasca aumentando l'efficacia degli ultrasuoni

Dati tecnici:

- Capacità vasca: 27 litri
- Rubinetto di scarico
- Potenza: 500 Watt
- Potenza di riscaldamento: 500 Watt
- Regolazione temperatura: 0÷80°C
- Regolazione tempo di lavaggio: 0-99 minuti
- Frequenza: 40 kHz
- Alimentazione: 220/230V
- Dimensioni: 530x330x380 mm
- Dimensioni serbatoio: 500x300x200 mm
- Dimensioni cestello: 450x250x150 mm
- Portata massima: 25 kg

1895 27 Max 25 € 1.640,00 1 018950270

1895/RC

cestello per vasche ad ultrasuoni 1895



	L mm	L1 mm	A mm	€		
1895/RC6	250	105	100	48,00	1	018950506
1895/RC13	257	185	100	76,00	1	018950513
1895/RC27	450	250	150	128,00	1	018950527

9881U



9881U 1 (1-2) 567
9881U 1 (3) 567

9882R



9882R 1 (1-2) 567
9882R 1 (3) 567

1897

sabbiatrice da banco professionale

Particolarmente indicata per operazioni di finitura superficiale di vari materiali (metallo, plastica, vetro, ceramica, legno, ecc.). La cabina è realizzata in lamiera di acciaio con opportuni rinforzi per assicurare la massima robustezza e stabilità.

La cabina è dotata di:

- porta di carico con chiusura a magneti
- piano in lamiera forata
- attacco standard per aspiratori ø 36 mm
- finestra di visualizzazione in policarbonato protettivo da 6 mm
- illuminazione con lampada a LED
- circuito pneumatico (entrata aria compressa)
- pistola di sabbatura con funzionamento a grilletto



CE

DATI TECNICI

Dimensioni utili cabina: 600x520x320 mm
Dimensioni di ingombro: 660x530x500 mm
Peso: 38 kg
Piano lavoro: lamiera forata
Illuminazione: LED
Consumo aria: 340 l/min a 7 atm
Alimentazione: 220 V - 50 Hz

1897 € 3.650,00 1 018970066

1897/CRB

corindone per sabbatrice 1897 in sacco da 25 kg



1897CRB € 183,00 1 018970101

1897/G

garnet per sabbatrice 1897 in sacco da 25 kg



1897G € 147,00 1 018970104

1897/MV

microsfere di vetro per sabbatrice 1897 in sacco da 25 kg



1897MV € 242,00 1 018970103

1898/K40

vasca manuale per la pulizia di pezzi meccanici a ricircolo con liquido riscaldato e batteri.

- permette l'eliminazione dei costi di smaltimento per solventi o idrocarburi
- utilizzando il detergente ecologico Beta a base di enzimi e batteri permette la rimozione e lo smaltimento dei vari residui oleosi presenti sui pezzi meccanici
- la funzione enzimatica aiuta a scindere la parte oleosa dalla parte solida di sporco mentre i batteri trasformano la stessa in anidride carbonica e acqua rigenerando costantemente il detergente



CE

Dotata di:

- Spazzola a setole lunghe e tubazione di collegamento
- Predisposizione per utilizzo destrorso e sinistrorso
- Griglia forata in acciaio inox
- Ruote con freno
- Scheda con display per visualizzazione temperatura di funzionamento e avviso livello troppo basso

Include:

- N° 2 taniche di liquido detergente ecocompatibile da 20 litri e n° 2 confezioni di batteri

Dati tecnici:

- Portata massima pompa: 10 litri/minuto
- Capacità serbatoio: 40 litri
- Temperatura di funzionamento: +5°C ÷ +40°C
- Dimensioni: 900 x 1000 x 750 mm
- Dimensioni interne vasca: 710 x 370 x 200 mm
- Peso: 50 kg a vuoto

1898/K40 € 4.860,00 1 018980004

ATTENZIONE:

Paesi in cui possibile distribuire il prodotto 1898/K40 sono: Austria, Belgio, Francia, Italia, Paesi Bassi, Polonia, Portogallo, Regno Unito, Spagna, Ungheria

1898/B

flacone di batteri da 300 ml per vasca lava pezzi 1898/K40



1898/B € 100,00 1 018980904

ATTENZIONE:

Paesi in cui è possibile distribuire il prodotto 1898/B sono: Austria, Belgio, Francia, Italia, Paesi Bassi, Polonia, Portogallo, Regno Unito, Spagna, Ungheria

1898/D

tanica di liquido detergente ecocompatibile da 20 litri per vasca lava pezzi 1898/K40



1898/D € 199,00 1 018980920

ATTENZIONE:

Paesi in cui è possibile distribuire il prodotto 1898/D sono: Austria, Belgio, Francia, Italia, Paesi Bassi, Polonia, Portogallo, Regno Unito, Spagna, Ungheria

1898/M

nebulizzatore a pressione con serbatoio da 1,5 Litri

- ugello regolabile per getto lineare o nebulizzato
- scala graduata da 0,5l - 1l - 1,5l
- leva con blocco per getto continuo
- non utilizzabile con idrocarburi



H mm 340 l 1,5 € 16,10 1 018980930

1898/S

pompa manuale a pressione con serbatoio da 5 Litri

- lancia in acciaio inossidabile
- leva con blocco per getto continuo
- ugello regolabile per getto lineare o nebulizzato
- comoda tracolla per il trasporto
- maniglia con aggancio per la lancia
- tubo flessibile da 1,2 m
- non utilizzabile con idrocarburi



H mm 415 l 5 € 28,00 1 018980932



1899A

macchina per pulizia sistemi DPF e FAP®

Mediante l'utilizzo di appositi detergenti è possibile pulire periodicamente e ripristinare sistemi DPF e FAP® compromessi da accumuli di fuliggine e ceneri. I risultati sono verificabili mediante autodiagnosi, dove si possono leggere i valori di massa fuliggine e di pressione differenziale nel filtro antiparticolato prima e dopo il trattamento.



In dotazione:

- 1 tubo di mandata lungo 2 m
- 1 raccordo a innesto rapido + portagomma per tubazioni sensore differenziale
- 1 niple M18x1,5 con portagomma per collegamento diretto con sonda Lambda
- 1 tubo prolunga
- 1 spruzzatore per DPF e FAP®
- 1 supporto magnetico per tubo
- 1 tubo per DPF e FAP® con pressacavo di regolazione più niple M14/16/18 mm per collegamento con sonde Lambda

Caratteristiche tecniche:

- Tensione di utilizzo 12 V
- Lunghezza cavi di alimentazione 3,9 m
- Capacità serbatoio 1 l

1899A € 1.325,00 1 018990010

1899SI

macchina 2in1 per la pulizia degli iniettori e del collettore di aspirazione

mediante l'utilizzo di appositi detergenti è possibile pulire periodicamente gli iniettori in motori diesel, benzina e GPL ed il collettore di aspirazione in motori diesel e benzina, eliminando i depositi carboniosi ed i residui della combustione



Caratteristiche tecniche:

- Tensione di utilizzo 12 V
- Pressione d'esercizio programmabile
- Tempi di nebulizzazione programmabili
- 2 tubi di servizio con raccordi a presa rapida per sistemi d'iniezione
- 1 attacco con raccordo a presa rapida per collettore di aspirazione
- 2 serbatoi (capacità 1 l/cad)
- Kit di raccordi universali per sistemi d'iniezione in pratica valigetta

1899SI € 4.960,00 1 018990030

2080/VG

portaminuteria in ABS con vassoi girevoli

- Dotato di un contenitore portaminuteria superiore (diametro 145 mm) e 4 vassoi girevoli:
 - 1 diametro 305 mm
 - 3 diametro 445 mm
- Fornito completo di 12 divisori applicabili all'interno dei 3 vassoi girevoli grandi per ottenere fino a 8 scompartimenti per piano



2080/VG € 179,00 1 020800100

445x445x550 mm - 3,4 kg

2250-0

seggolino girevole con vassoio



2250-0 € 115,00 1 022500011

2252

seggolino con rotelle



2252-G € 193,50 1 022520002

2252KR4

4 ruote di ricambio seggolino 2252



2252KR4 € 65,00 1 022520900

2258N-0

seggolino con cassettera



2258N-0	€ 199,00	1	022580021
---------	----------	---	-----------

2258RR

ruota di ricambio seggolino 2258N



2258RR	€ 11,00	1	022580111
--------	---------	---	-----------

2254A

teli copriauto da esterno, idrorepellenti e resistenti ai raggi UV

questi teli sono ottimi per proteggere i veicoli incidentati in attesa di riparazione

caratteristiche tecniche

- finitura esterna con trattamento di protezione raggi UV
- finitura interna morbida antigraffio
- 6 laccetti di regolazione per rendere il telo aderente alla vettura
- 2 cerniere in corrispondenza delle porte anteriori per permettere di accedere al veicolo senza dover rimuovere il telo
- sedi per gli specchietti
- catarifrangenti



Disponibile in 3 misure:

- M indicata per utilitarie
- L indicata per berline e station wagon
- XL indicata per SUV

	LxPxH mm	€		
/M	4400x1450x1300	162,00	1	022540002
/L	5300x1450x1150	181,00	1	022540000
/X	4700x1450x1580	166,00	1	022540001

2254C

protezione a ventosa per carrozzeria veicoli

In tessuto plastificato con 4 ventose sul lato superiore



2254C	L1 mm	L2 mm	€ 53,00	1	022540200
-------	----------	----------	---------	---	-----------

2254F

protezione anteriore auto

Permette di proteggere la parte frontale del veicolo lasciando le aperture per i fari e il radiatore



- Lavabile
- Impermeabile e resistente ad oli e grassi
- Fissaggio tramite lacci
- Materiale: 98% poliammide/nylon, 2% poliuretano

2254F	€ 90,50	1	022540150
-------	---------	---	-----------

2254K

protezione riutilizzabile per sedile, volante e pomello del cambio

adatta alla maggior parte dei sedili, volanti e pomelli dei cambi di autoveicoli



2254K	€ 31,00	1	022540101
-------	---------	---	-----------

2254SM

tappeto sottomacchina in EVA

doppia finitura:

- 1 lato in morbido EVA
- 1 lato in carbon look rigido per favorire lo scivolamento



2254SM	€ 71,50	1	022540033
--------	---------	---	-----------

2254T

tappeto per protezione ginocchia

Realizzato in EVA antiscivolo



2254T	€ 31,50	1	022540047
-------	---------	---	-----------

3000L

lettino sottomacchina

- Rivestimento in PVC con imbottitura in gomma piuma per un elevato comfort.
- Inclinazione cuscino: 30°



3000L	€ 183,00	1	030000210
-------	----------	---	-----------

3000L/RLS

ruota di ricambio lettino sottomacchina



3000L/RLS	€ 13,30	6	030000212
-----------	---------	---	-----------

3002 lettino sottomacchina e seggiolino

- struttura in acciaio
- rivestimento in PVC con imbottitura
- possibilità di regolare la posizione rapidamente: lettino o seggiolino



3002 € 121,50 1 030020001

3002/RLS

6 ruote di ricambio per lettino sottomacchina. 3002



3002/RLS € 31,50 1 030020501

3003

lettino sottomacchina in plastica antiurto

- Ø ruote: 76 mm



3003 € 94,50 1 030030001

3003/RLS

6 ruote di ricambio per lettino sottomacchina 3003



3003/RLS € 49,00 1 030030501

Beta

3003C

lettino sottomacchina in plastica antiurto

- Dotato di:
- cuscino per la testa e per la zona lombare con finitura in carbon look
 - piastrine superiori in metallo per il fissaggio di accessori magnetici
 - 6 ruote in gomma con diametro 79 mm
 - Portata max. 120 Kg
 - Peso 5,5 Kg



3003C € 256,00 1 030030100

3003C/RLS

6 ruote di ricambio per lettino sottomacchina 3003C



3003C/RLS € 102,50 1 030030600

3003PRO

lettino sottomacchina in materiale plastico antiurto

- Dotato di:
- cuscino poggiatesta ergonomico
 - protezione morbida per la schiena
 - 2 ruote da 178 mm con doppio cuscinetto che permettono l'utilizzo anche su superfici sconnesse e il superamento di tubi/cavi
 - 1 ruota girevole
 - doppia regolazione dell'altezza da terra: 38 o 76 mm
 - 2 lampade a led portatili da 250 lumen con magneti per fissaggio
 - capacità di carico: 200 kg
 - peso: 7,7 kg



C max kg	H min mm	H Max mm	H1 mm
200	170	230	230

€ 359,00 1 030030150

3003PRO/SP

supporto in plastica da parete per lettino 3003PRO

Può essere applicato su una parete, ponte, cassetteria o altro permettendo il fissaggio del lettino attraverso un sistema rapido e veloce con chiusura di sicurezza.



3003PRO/SP € 96,00 1 030030151

3003PRO/PM

portaminuterie magnetico tondo per lettino 3003PRO

applicandolo sul cerchio delle ruote del lettino permette il trattenimento delle minuterie durante gli interventi



3003PRO/PM € 10,30 1 030030152

3003PRO/RCR

coppia ruote di ricambio posteriori per lettino sottomacchina 3003PRO



3003PRO/RCR € 76,00 1 030030650

Beta

3003PRO/RRG

ruota di ricambio girevole anteriore per lettino sottomacchina 3003PRO



3003PRO/RRG

€ 23,80

1 030030651

3003PRO/RT

lampada a led con magneti di ricambio per lettino sottomacchina 3003PRO

- 250 lumen
- pile : 4xAAA non incluse



3003PRO/RT

€ 17,30

1 030030652

3004

cuneo fermaruota

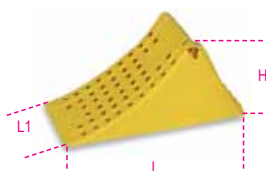

	H	L	L1
	mm	mm	mm
3004	225	475	200

€ 39,00

1 030040000

AUTORIPARAZIONE

I nostri utensili per autoriparazione, usati dai professionisti più esigenti, sono sviluppati e prodotti per soddisfare gli standard più elevati al mondo e testati continuamente nelle condizioni di utilizzo più stressanti.

Da oltre 50 anni, siamo orgogliosamente a fianco dei più grandi campioni, che ci aiutano a migliorare costantemente i nostri prodotti e ne confermano il livello di qualità più assoluta.

Gli utensili dedicati all'autoriparazione si trovano in queste sezioni:

Diagnostica	da 1438 a 1499 da 1758VT a 1760TMC
Motore	da 955 a 989A da 1438 a 1499
Olio e filtri	da 1438 a 1499 da 1877 a 1885
Impianto elettrico	da 1438 a 1499
Avviatori	da 1498BC/12 a 1498/40A
Trasmissione	da 1438 a 1499
Sospensioni	da 1549 a 1569CP
Freni	da 1438 a 1499
Ruote	da 955 a 989A
Carrozzeria	da 1302 a 1369 da 1763 a 1767A
Altre attrezzature	da 1875LT a 3067
Sollevatori	da 3029/2T a 3067/70-13T



3006

sollevatore e posizionatore ruote trattori ed escavatori

- portata massima 1500 kg
- diametro ruota minimo 1000 mm
- diametro ruota massimo 2200 mm
- spessore ruota massimo 800 mm

CE



3006

€ 1.920,00

1 030060000

3006 R/RGF

ruota girevole con freno di ricambio per sollevatore e posizionatore ruote 3006



3006 R/RGF

€ 73,50

1 030060501

3006 R/RG

ruota girevole di ricambio per sollevatore e posizionatore ruote 3006



3006 R/RG

€ 64,00

1 030060502

3007

carrello sottoscocca per veicoli senza meccanica anteriore/posteriore

- per movimentare agevolmente i veicoli privi di avantreno o retrotreno durante le fasi di lavorazione
- 4 ruote pivotanti, di cui 2 con freno, adatte all'uso in fondo di verniciatura
 - 2 supporti scorrevoli per adattarsi a tutti i telai
 - portata massima 800 kg

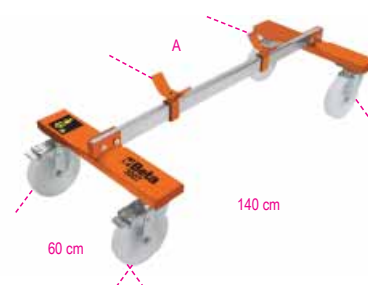

	A Max
	mm
3007	110

€ 690,00

1 030070001

Beta

3007 R/RGF

ruota girevole con freno di ricambio per carrello sottoscocca per veicoli 3007



3007 R/RGF € 114,00 1 030070501

3007 R/RG

ruota girevole di ricambio per carrello sottoscocca per veicoli 3007



3007 R/RG € 99,50 1 030070502

3008N

sollevatore e posizionatore ruote Truck singole e gemellari

- portata massima 500 kg
- altezza minima 120 mm
- altezza massima 650 mm
- interasse rulli 429÷670 mm
- sicurezza idraulica in caso di sovraccarico
- ruote anteriori pivotanti

CE



3008N € 3.260,00 1 030080110

3009

carrello per movimentazione veicoli

- portata Max 550 kg
- 4 rulli basculanti
- larghezza rulli 200 mm
- per ruote fino a 240 mm di larghezza



A 400÷850 mm B 600 mm € 452,00 1 030090001

3009R/GR4

gruppi 4 ruote carrelli 3009 R/GR4



3009R/GR4 € 184,50 1 030090501

3010/T...

coppia cavalletti



C max	H min	H Max	H1	L	L1
kg	mm	mm	mm	mm	mm
2000	280	425	245	185	165

3010T 2 € 106,50 1 030100002

C max	H min	H Max	H1	L	L1
kg	mm	mm	mm	mm	mm
3000	285	430	250	180	195

3010T 3 € 126,50 1 030100003

C max	H min	H Max	H1	L	L1
kg	mm	mm	mm	mm	mm
6000	400	580	340	245	280

3010T 6 € 183,50 1 030100006

C max	H min	H Max	H1	L	L1
kg	mm	mm	mm	mm	mm
10000	471	735	420	330	290

3010T 10 € 316,00 1 030100010

3011/T

sollevatori idraulici a bottiglia

CE



C max	H min	H Max	L
kg	mm	mm	mm
2000	174	369	90

3011T 2 € 95,00 1 030110020

C max	H min	H Max	L
kg	mm	mm	mm
3500	170	366	86

3011T 3,5 € 106,50 1 030110035

C max	H min	H Max	L
kg	mm	mm	mm
5000	203	467	118

3011T 5 € 119,50 1 030110050

C max	H min	H Max	L
kg	mm	mm	mm
10000	220	484	114

3011T 10 € 179,00 1 030110150

C max	H min	H Max	L
kg	mm	mm	mm
15000	230	497	113

3011T 15 € 219,00 1 030110150

C max	H min	H Max	L
kg	mm	mm	mm
20.000	245	521	115

3011T 20 € 314,00 1 030110200

3010H

cavalletti serie pesante



C Max	H min	H Max	L	L1
kg	mm	mm	mm	mm
15,000	445	631	300	300

3010H631-T15 € 342,00 1 030100150

C Max	H min	H Max	L	L1
kg	mm	mm	mm	mm
15,000	645	1077	300	300

3010H1077-T15 € 429,00 1 030100165

3010V

cavalletti serie pesante con regolazione a vite



C Max	H min	H Max	L	L1
kg	mm	mm	mm	mm
20,000	410	600	330	330

3010V600-T20 € 498,00 1 030100200

C Max	H min	H max	L	L1
kg	mm	mm	mm	mm
20,000	665	1090	460	460

3010V1090-T20 € 633,00 1 030100220

3012

staffe sostegno motore



L mm	C max kg	€	1	030120010
1500	500	325,00	1	030120010
1800	400	441,00	1	030120018

3012C

staffa sostegno motore inferiore

ideale per auto e veicoli commerciali



3012C	€	1	030120255
	860,00	1	030120255

3012I

staffa sostegno motore inferiore

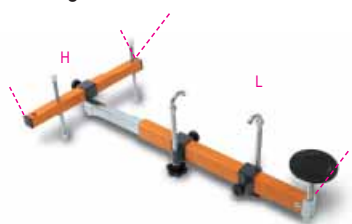

3012I	L mm	H mm	€	1	030120250
	630-960	190	763,00	1	030120250

3014

cavalletto sostegno motore



3014	€	1	030140010
	410,00	1	030140010

3014R/GR5

5 ruote di ricambio per cavalletto sostegno motore 3014



3014R/GR5	€	1	030140501
	102,50	1	030140501

3014 SAR

cavalletto sostegno motore richiudibile

- facilmente richiudibile con notevole riduzione degli ingombri
 - permette la rotazione di 360° del motore o del cambio
 - garantisce la massima sicurezza e stabilità durante gli interventi
- Portata massima: 450 kg



3014SAR	€	1	030140360
	1.500,00	1	030140360

3014SAR/RR

4 ruote di ricambio per cavalletto sostegno motore 3014SAR



3014SAR/RR	€	1	030140370
	163,00	1	030140370

3014SAR/1

vasca di raccolta liquidi per 3014 SAR

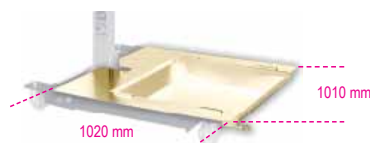

3014SAR/1	€	1	030140361
	440,00	1	030140361

1020x1010x11 mm

3014SAR/2

staffa per il fissaggio della trasmissione sul cavalletto 3014 SAR

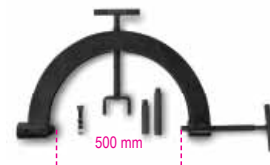

3014SAR/2	€	1	030140362
	424,00	1	030140362

3023

sostegno da fossa e sottoponte con regolazione a vite

portata massima 350 kg

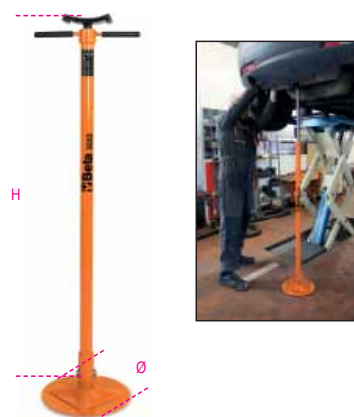

3023	H min-Max mm	Ø mm	€	1	030230050
	1350-2030	300	226,00	1	030230050

3025N

gru idraulica pieghevole con pompa a doppio effetto

- Caratteristiche:
- Portata massima: 1 t
 - 4 posizioni di carico: 300-600-800-1000 kg
 - Con valvola limitatrice di carico e stelo cromato
 - Velocità di discesa controllata
 - Ruote in nylon
 - Altezza massima: 2420 mm



A mm	B mm	C mm	D mm	€	1	030250110
1560	1600	1000	880	2.315,00	1	030250110

3025N/PF

pinza movimentazione fusti

Portata massima 300 kg

CE



	A mm	B mm	€	1	030250111
3025N/PF	550+640	70	506,00	1	030250111

3026 0,3

sollevatore idraulico da fossa e sottoponte

Portata massima: 300 kg

CE



	H min mm	H Max mm	L mm	L1 mm	Ø mm	€	1	030260003
3026 0,3	1120	1970	450	450	25	738,00	1	030260003

3026/R0,3

4 ruote girevoli di ricambio per sollevatore idraulico 3026 0,3



	€	1	030260903
3026/R 0,3	186,00	1	030260903

3026 0,5

sollevatore idraulico da fossa e sottoponte

Portata massima 500 kg

CE



	H min mm	H Max mm	L mm	L1 mm	Ø mm	€	1	030260005
3026 0,5	1140	1990	600	550	30	878,00	1	030260005

3026/R0,5

4 ruote girevoli di ricambio per sollevatore idraulico 3026 0,5



	€	1	030260905
3026/R 0,5	259,00	1	030260905

3026 1,0

sollevatore idraulico da fossa e sottoponte

Portata massima 1t

CE

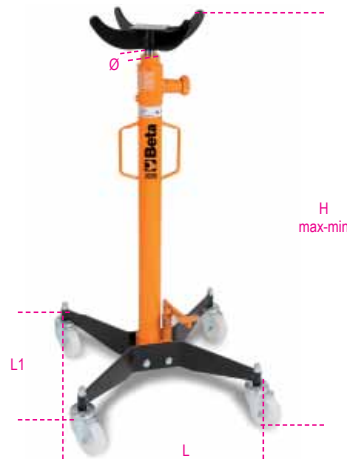

	H min mm	H Max mm	L mm	L1 mm	Ø mm	€	1	030260010
3026 1,0	1140	1990	650	550	35	1.060,00	1	030260010

3026/R 1,0

4 ruote girevoli di ricambio per sollevatore idraulico 3026 1,0



	€	1	030260910
3026/R 1,0	334,00	1	030260910

3026/S

supporto orientabile per trasmissioni con boccole di riduzione per sollevatori 3026

portata massima 500 kg

CE



	€	1	030260501
3026/S	624,00	1	030260501

3026/SP

supporto universale per trasmissioni

permette ad un solo operatore di smontare e rimontare le trasmissioni di autoveicoli, veicoli commerciali e fuoristrada con rapidità e sicurezza.

DATI TECNICI

Adatto per steli con diametro: 25-30-35-45 mm

Portata massima: 150 kg

Altezza: 250 mm

CE



	€	1	030260505
3026/SP	726,00	1	030260505

3026/SA

supporto mozzo ruota per sollevatori da fossa

- utilizzabile per interventi di manutenzione inerenti ai mozzi, e durante le operazioni di sostituzione degli ammortizzatori
- adattabile ai sollevatori idraulici da fossa 3026 0,3 e 3026 0,5



	Ø mm	€	1	030260510
3026/SA	30,4	151,50	1	030260510

3026/SAM

supporto ammortizzatori per sollevatori da fossa

- utilizzabile per sostenere l'ammortizzatore quando si smonta il braccio della sospensione
- staffa per ammortizzatori con diametro Max 80 mm, più riduzione per diametri Max 60 mm
- adattabile ai sollevatori idraulici da fossa 3026 0,3 e 3026 0,5



	€	1	030260515
3026/SAM	196,00	1	030260515

3027N 10

pressa idraulica da banco con pistone mobile

Caratteristiche:

- Capacità massima: 10 t
- Pompa manuale a 2 velocità
- Pistone mobile
- Ritorno automatico del pistone
- Serie prismi a V inclusi
- Stelo cromato

CE

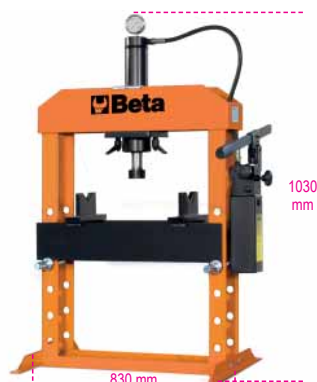

3027N 10 € 2.045,00 1 030270101

3027N 20

pressa idraulica con pistone mobile

Caratteristiche:

- Capacità massima: 20 t
- Pompa manuale a 2 velocità
- Pistone mobile
- Stelo cromato
- Ritorno automatico del pistone
- Sicurezza idraulica in caso di sovraccarico
- Manometro
- Serie prismi a V inclusi

CE



3027N 20 € 2.830,00 1 030270102

3027N 30

pressa idraulica con pistone mobile ed argano

Caratteristiche:

- Capacità massima: 30 t
- Pompa a mano a 2 velocità
- Pistone mobile
- Stelo cromato
- Ritorno automatico del pistone
- Sicurezza idraulica in caso di sovraccarico
- Manometro
- Serie di prismi a V
- Argano a funi d'acciaio per il sollevamento del piano di lavoro

CE



3027N 30 € 4.950,00 1 030270103

3027N 50

pressa idraulica con pistone mobile ed argano

Caratteristiche:

- Capacità massima: 50 t
- Pompa a mano a 2 velocità
- Pistone mobile
- Stelo cromato
- Ritorno automatico del pistone
- Sicurezza idraulica in caso di sovraccarico
- Manometro
- Serie di prismi a V
- Argano a funi d'acciaio per il sollevamento del piano di lavoro

CE



3027N 50 € 6.900,00 1 030270105

3027N 100

pressa elettroidraulica motorizzata con pistone mobile ed argano

- capacità massima: 100 t
- motore trifase 230-400 V
- frequenza 50 Hz
- potenza motore elettrico 3 Kw
- pompa elettroidraulica a 2 velocità
- comando con distributore a leva in 3 posizioni: avanzamento-neutro-ritorno
- pistone mobile
- Ø pistone: 100 mm
- Sollevamento piano di lavoro tramite argano a fune d'acciaio
- Cavo di alimentazione con presa industriale 380V a 4 poli
- Olio motore già incluso

CE



3027N 100 € 21.280,00 1 030270110

3027N/KP

serie di cacciaspine e piastra per pressa 3027N
Ø cacciaspine: 5-10-14-18-24-29 mm

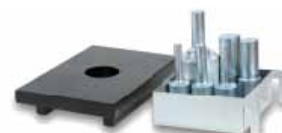

Model	Capacity	Price (€)	Code
3027N/KP10-20	3027N10-20	379,00	1 030270511
3027N/KP30	3027N 30	530,00	1 030270531
3027N/KP50	3027N 50	648,00	1 030270541
3027N/KP100	3027N 100	1.190,00	1 030270552

3027N/KPP

comando a pedale per presse idrauliche 3027N



Model	Capacity	Price (€)	Code
3027N/KPP10	3027N10-20	405,00	1 030270560
3027N/KPP50	3027N 50	460,00	1 030270565



3027/PR

supporto pressa per estrazione/introduzione mozzi, cuscinetti e silent block

Sistema universale che, operando sotto pressa, attraverso una base di appoggio e relativi accessori, permette lo smontaggio/montaggio di mozzi, cuscinetti e silent block dalla loro sede. L'attrezzo si adatta alle conformazioni geometriche irregolari dei mozzi/perni fusi sui quali l'operatore deve intervenire.



Dati tecnici:

- Campo di lavoro: Min. 130 mm - Max. 186 mm
- Dimensioni: 300 x 300 mm
- Peso: 13 kg
- Portata massima: 20 t

3027/PR € 668,00 1 030270400

3028 15

pressa idraulica da banco con pistone mobile

Caratteristiche:

- Capacità massima: 15 t
- Piano regolabile in altezza manuale
- Pistone scorrevole
- Sicurezza idraulica in caso di sovraccarico
- Manometro
- Serie primi a V inclusi



A mm 1010 B mm 565 C mm 480 D mm 80+370 € 1.111,00 1 030280015

3028SP/15

schermo di protezione per pressa 3028 15



3028SP/15 € 161,50 1 030280016

3028 20

pressa idraulica con pistone mobile

capacità massima: 20 t
piano regolabile in altezza
pistone scorrevole

CE

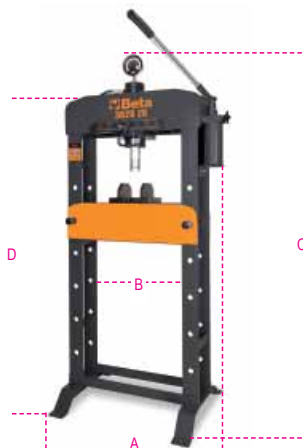

A mm 850 B mm 540 C mm 1830 D mm 1602 € 1.615,00 1 030280020

3028SP/20

schermo di protezione per presse 3028 20



3028SP/20 € 180,50 1 030280021

3028 30

pressa idraulica con pistone mobile

capacità massima: 30 t
piano regolabile in altezza
pistone scorrevole

CE

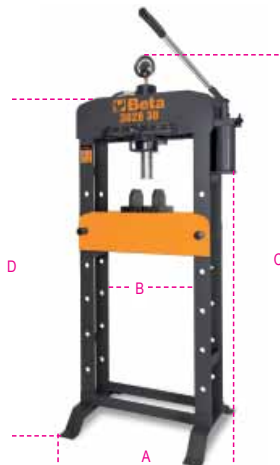

A mm 850 B mm 540 C mm 1850 D mm 1650 € 2.250,00 1 030280030

3028SP/30

schermo di protezione per presse 3028 30



3028SP/30 € 180,50 1 030280031

3028 50

pressa idraulica con pistone mobile ed argano

capacità massima: 50 t
piano regolabile in altezza tramite argano
pistone scorrevole

CE

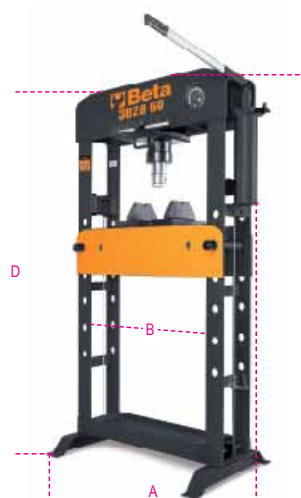

A mm 1100 B mm 750 C mm 1850 E mm 820 € 3.940,00 1 030280050

3028SP/50

schermo di protezione per presse 3028 50



3028SP/50 € 191,50 1 030280051

3028/KP

kit cacciaspine per presse 3028



3028/KP € 140,00 1 030280055



3029/2T

sollevatore idraulico ribassato a 4 ruote da 2 tonnellate

- Pedale di avvicinamento rapido
- Struttura in acciaio e ruote in nylon
- Altezza minima 75 mm

CE



3029/2T € 449,00 1 030290020

3029L/2T

sollevatore idraulico lungo ribassato da 2 tonnellate

Permette di operare su veicoli con bassa altezza da terra e punto di sollevamento interno

- Velocità di discesa controllata
- Pedale di avvicinamento rapido
- Ruote in nylon

CE



3029L/2T € 520,00 1 030290120

3029/2T-L/RP

piattello di ricambio in gomma 85 mm per 3029/2T, 3029L/2T, 3030H/2T



3029/2T-L/RP € 17,60 1 030290502

3029/2T-L/R6

ruota posteriore di ricambio per 3029/2T, 3029L/2T, 3030H/2T, 3033E/3T



3029/2T-L/R6 € 57,00 1 030290506

3029/2T-L/R5

ruota anteriore di ricambio per sollevatore 3029/2T, 3029L/2T, 3030H/2T



3029/2T-L/R5 € 53,00 1 030290505

3030/2T

sollevatore idraulico ribassato 2 t a 6 ruote

- doppie ruote anteriori basculanti in materiale plastico (PTFE)
- ottima manovrabilità del sollevatore su pavimentazioni sconnesse e irregolari
- portata massima: 2 tonnellate

CE



3030/2T € 854,00 1 030300020

43 kg

3030/2T-R5

ruota anteriore con perno per sollevatore 3030 2T



3030 2T/R5 € 30,00 1 030300505

3030/2T-R6

ruota posteriore di ricambio per 3030/2T, 3033/3T



3030 2T/R6 € 46,50 1 030300506

3030/2TRP

piattello di ricambio in gomma 85 mm per 3030/2T, 3033/3T



3030/2TRP € 6,05 5 030300501

3030H/2T

sollevatore idraulico grande alzata a 6 ruote da 2 tonnellate

permette di operare su veicoli con elevata altezza da terra e con grande escursione degli ammortizzatori

- velocità di discesa controllata
- pedale di avvicinamento rapido
- ruote in nylon

CE



H min-Max mm 85÷780 L mm 1010 L1 mm 300 € 715,00 1 030300220

3033/3T

sollevatore idraulico 3t versione lunga

- per utilizzo su veicoli commerciali
- portata massima: 3 tonnellate
- ruote in poliammide

CE



3033/3T € 1.130,00 1 030330030



3033E/3T

sollevatore idraulico
da 3 tonnellate

- velocità di discesa controllata
- ruote in nylon

CE



	H	L	L1		
	min-Max	mm	mm	mm	
3033E/3T	95-515	700	370	€ 419,00	1 030330130

3033S 3T/R2

ruota anteriore di ricambio
per sollevatore 3033E/3T



3033S 3T/R2	€ 48,00	1 030330532
-------------	---------	-------------

Beta

3035

carrello trasporta pneumatici

- per trasportare agevolmente pneumatici fino ad un massimo di 980 mm di diametro
- la solida struttura permette di movimentare i pneumatici senza doverne sopportare fisicamente il peso
- utilizzabile come piano d'appoggio, grazie al blocco della posizione in orizzontale
- 2 ruote Ø 260 mm
- 2 ruote Ø 125 mm
- altezza massima trasportabile 1,60 m
- portata massima 200 kg
- forche regolabili in 2 posizioni:
prima posizione apertura massima 880 mm
seconda posizione apertura massima 980 mm



3035	€ 1.030,00	1 030350100
------	------------	-------------

3036

base per movimentazione ruote

ruote in gomma antitraccia



3036	€ 121,50	1 030360063
------	----------	-------------

3061/2T

sollevatore pneumatico 2 t - 2 stadi

CE



Dotato di:

- membrana alta resistenza a tre strati e guida telescopica interna
- dispositivo d'arresto a fine corsa e valvola di sicurezza per carichi eccessivi
- possibilità di utilizzo anche sui ponti sollevatori

DATI TECNICI

portata: 2 t
peso: 14 kg
pressione di alimentazione: 8-10 bar
altezza: min.132 - max. 326 mm

3061/2T	€ 957,00	1 030610020
---------	----------	-------------

3061/2T-P50

prolunga da 50 mm per 3061/2T



3061/2T P50	€ 81,50	1 030610021
-------------	---------	-------------

3061/2T-P100

prolunga da 100 mm per 3061/2T



3061/2T P100	€ 109,00	1 030610022
--------------	----------	-------------

Beta

Beta

3065/20-10T

sollevatore oleopneumatico 20-10T
con valigia di trasporto

Portatile e leggero, ideale per gli interventi
di assistenza su strada

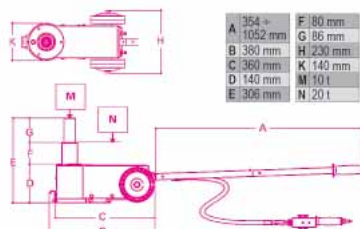

- include due prolunghe da 75 e 60 mm

DATI TECNICI

portata: 20-10 tonnellate

peso: 23 kg

pressione di alimentazione: 8-10 bar

consumo d'aria: 400 l/min

3065/20-10T

2.830,00



1 030650100

3065/40-20T

sollevatore oleopneumatico 40-20 t

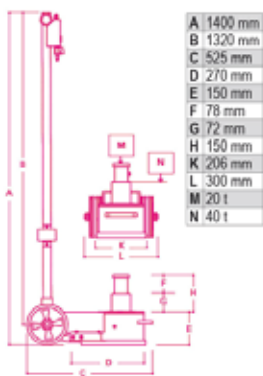
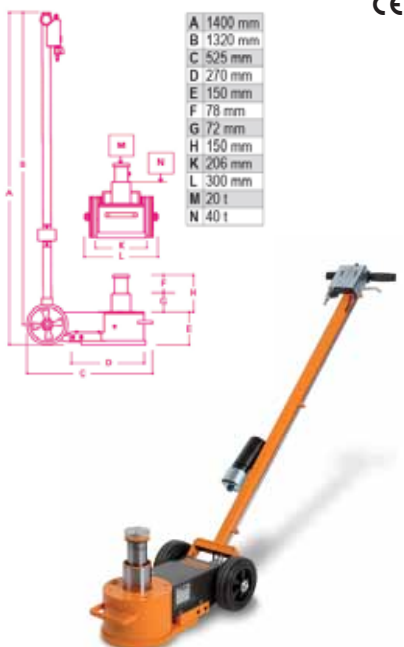

- indicato per utilizzo su mezzi pesanti
- pratico e maneggevole per trasporto anche su officine mobili
- rientro automatico dei pistoni
- due valvole di discesa con controllo velocità sotto carico
- include due prolunghe da 70 e 120 mm

DATI TECNICI

portata: 40-20 tonnellate

peso: 39 kg

pressione di alimentazione: 8-10 bar

consumo d'aria: 400 l/min

3065/40-20T

3.180,00



1 030650200

3067/60-15T

sollevatore oleopneumatico 60-30-15T

Con un'altezza minima di soli 120 mm
è particolarmente indicato per utilizzo
su autobus, pullman e mezzi di trasporto pubblici

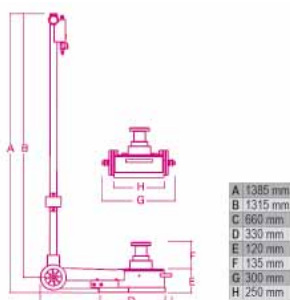
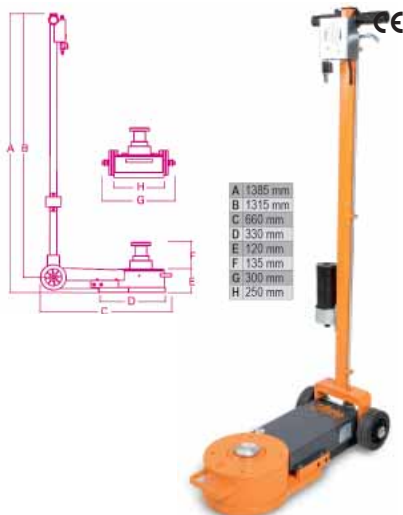

- rientro automatico dei pistoni
- due valvole di discesa con controllo velocità sotto carico
- include due prolunghe da 70 e 120 mm

DATI TECNICI

portata: 60-30-15 tonnellate

peso: 56 kg

pressione di alimentazione: 8-10 bar

consumo d'aria: 600 l/min

3067/60-15T

4.690,00



1 030670120

3067/70-13T

sollevatore oleopneumatico 70-43-23-13 t

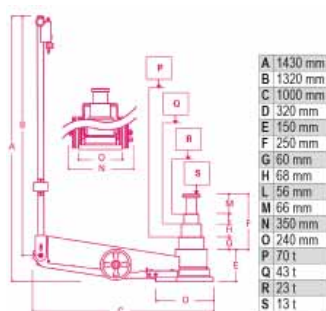
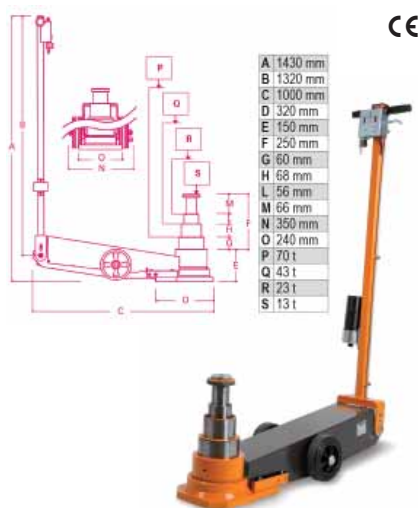

- Versione lunga, adatta all'utilizzo su autocarri, autoarticolati,
autobus e macchine agricole
- rientro automatico dei pistoni
- due valvole di discesa con controllo velocità sotto carico
- include due prolunghe da 70 e 120 mm

DATI TECNICI

portata: 70-43-23-13 tonnellate

peso: 74 kg

pressione di alimentazione: 8-10 bar

consumo d'aria: 600 l/min

3067/70-13T

5.910,00



1 030670130

3068

transpallet manuale
a forche ridotte

Caratteristiche:

- 2 ruote direzionali 200x50 mm in PU
- Rulli doppi anteriori 80x70 mm in PU
- Rulli guida per l'accesso al pallet
- tacca indicazione battuta di profondità
- valvola di controllo velocità di discesa
- valvola di sicurezza in caso di sovraccarico



Dati tecnici:

- Capacità massima: 2500 kg
- Lunghezza totale: 1200 mm
- Lunghezza forche: 800 mm
- Larghezza forche: 540 mm
- Larghezza singola forca: 160 mm
- Altezza leva: 1230 mm
- Altezza max. sollevamento: 115 mm

3068

840,00



1 030680000

3069

transpallet manuale

Caratteristiche:

- 2 ruote direzionali 200x50 mm in PU
- Rulli doppi anteriori 80x70 mm in PU
- Rulli guida per l'accesso al pallet
- tacca indicazione battuta di profondità
- valvola di controllo velocità di discesa
- valvola di sicurezza in caso di sovraccarico
- leva di azionamento in 3 posizioni



Dati tecnici:

- Capacità massima: 2500 kg
- Lunghezza totale: 1550 mm
- Lunghezza forche: 1150 mm
- Larghezza forche: 540 mm
- Larghezza singola forca: 160 mm
- Altezza leva: 1230 mm
- Altezza max. sollevamento: 115 mm
- Corridoio di stivaggio per pallet 800x1200 longitudinalmente: 1805 mm
- Raggio di volta: 1347 mm

3069

790,00



1 030690000



3040C

cavalletto posteriore per moto regolabile

- Verniciatura nera opaca
- 4 ruote in gomma termoplastica
- Include coppia di cursori a V
- Include coppia di cursori a L



3040C € 84,50 1 030400002

3040C/S1

coppia cursori a V per 3040C



3040C/S1 € 13,40 1 030400503

3040C/S2

coppia cursori a L in gomma per 3040C



3040C/S2 € 19,40 1 030400504

3041C

cavalletto anteriore per moto regolabile

- Verniciatura nera opaca
- 4 ruote in gomma termoplastica
- Include coppia di cursori a rulli
- Include coppia di cursori a cono



3041C € 79,00 1 030410002

3041C/12

coppia cursori a rulli per 3041C



3041C/12 € 18,70 1 030410512

UTENSILI PER MOTORIPARAZIONE

La famiglia di utensili Beta per la motoriparazione include prodotti specifici dedicati al settore dei motocicli.

Prodotti continuamente aggiornati la cui qualità è altamente apprezzata dai tecnici delle migliori squadre corse nel Motomondiale, Mondiale Superbike, Mondiale Motocross ed Enduro.



3041C/16

coppia cursori a cono per 3041C



3041C/16 € 12,80 1 030410516

3042C

cavalletto anteriore per canotto di sterzo moto

- Verniciatura nera opaca
- 4 ruote in gomma termoplastica
- Include kit di 8 perni Ø 13 - 15 - 15,5 - 17 - 19 - 20 - 21 - 27



3042C € 142,50 1 030420002

3043C

cavalletto per moto con monobraccio sinistro

- Verniciatura nera opaca
- 4 ruote in gomma termoplastica
- Perno optional



3043C € 104,00 1 030430002

3043C/ 41÷47

perno per 3043C



	Ø mm	€		
3043C/41 Ducati	21,5 ÷ 25,5	23,80	1	030430551
3043C/42 KTM - Triumph	27,5	23,80	1	030430552
3043C/43 MV	42,5	26,00	1	030430553
3043C/44 Ducati	40,5	26,00	1	030430554
3043C/45 Honda	28,5	23,80	1	030430555
3043C/47 BMW	53,5	30,50	1	030430557

3047C

cavalletto cross/enduro a pedale



3047C € 66,00 1 030470002

3048C

cavalletto cross racing in acciaio



3048C € 66,00 1 030480002

3050/CC

cavalletto centrale a vite sotto culla per Custom, Enduro, Cross, Scooter

Include kit di supporti regolabili



3050/CC € 169,50 1 030500012

3050/600

Sollevatore moto elettroidraulico da 600 kg

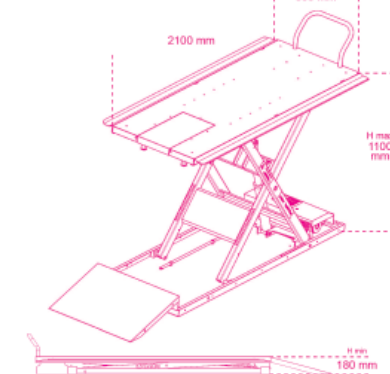

Caratteristiche tecniche:

- Sicurezze elettriche, meccaniche e idrauliche
- Portata: 600 kg
- Centralina elettroidraulica integrata: 230V - 50 Hz
- Pompa idraulica
- Velocità di discesa controllata
- Fusibili di sicurezza in caso di tranciatura del cavo
- Pulsantiera di comando
- Certificato ce omologato TÜV

	L mm	L mm	H min mm	H Max mm	€		
3050/O	975	2100	185	1110	5.720,00	1	030500201
3050/G	975	2100	185	1110	5.720,00	1	030500202
3050/R	975	2100	185	1110	5.720,00	1	030500203

3050/KA

kit di allargamento per sollevatore 3050/600



	A mm	B mm	€		
3050/KA-O	107,5	2100	1.145,00	1	030500221
3050/KA-G	107,5	2100	1.145,00	1	030500222
3050/KA-R	107,5	2100	1.145,00	1	030500223

3050/MS

morsa bloccaruota per sollevatore 3050/600

permette il bloccaggio della ruota anteriore della moto sul ponte



3050/MS € 650,00 1 030500032



3050/MV

morsa bloccaruota meccanica a vite per sollevatore 3050/600



3050/MV € 1.130,00 1 030500034

3050/LA

piano in lamiera antiscivolo per sollevatore 3050/600

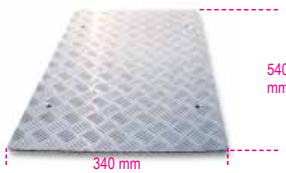

3050/LA € 130,00 1 030500062

9562T1

tappeto da officina 100X80 cm

particolarmente indicato per l'utilizzo sotto smontagomme per moto BETA 3071 e 3071B

- facile da pulire, fondo gommato e antiscivolo



9562T1 L cm 100 H cm 80 € 91,00 1 095620150

9562T3

tappeto da officina 300x160 cm

- particolarmente indicato per l'utilizzo sotto ponti sollevatori moto
- protegge il suolo da perdite d'olio, benzina e rispetta l'ambiente
- facile da pulire, fondo gommato e antiscivolo



9562T3 L cm 300 H cm 160 € 360,00 1 095620300

3054

base mobile per cavalletto centrale o per ruota posteriore moto con estensione per cavalletto laterale



3054 max kg 500 € 286,00 1 030540000

3055M

morsa automatica per furgoni

permette il fissaggio della ruota anteriore della moto



3055M € 109,00 1 030550002

3057

rampa in alluminio per carico/scarico moto

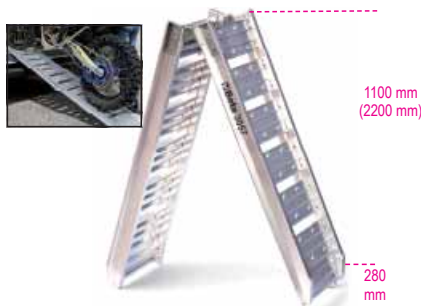

3057 € 232,00 1 030570001

3070B

equilibratrice statica manuale

misure coni:
 Øe 30 mm - Øi 10 mm
 Øe 30 mm - Øi 12 mm
 Øe 40 mm - Øi 14 mm



- permette l'equilibratura delle ruote in officina e sui campi gara
- dotata di cuscinetti volventi, livella di posizionamento e piedini regolabili per una massima precisione
- include 3 misure di coni per mozzi

3070B € 136,00 1 030700100

3070B/...

asta bilanciatrice per equilibratrice 3070B



	Ø1	Ø2	L	€	1	030700101
3070B/10	30	10	410	24,30	1	030700101
3070B/12	30	12	415	28,50	1	030700102
3070B/14	40	14	415	35,00	1	030700103

3070BE/K

equilibratrice elettronica portatile a lancio manuale

sistema di equilibratura con microprocessore a lancio manuale (senza motore) che permette l'equilibratura di ruote in ferro o in lega di auto e moto

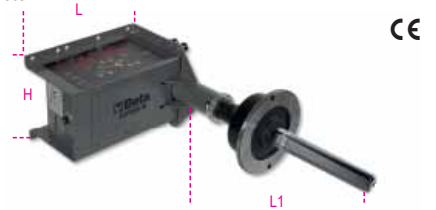

Caratteristiche:

- Compatta e facilmente trasportabile. Può essere utilizzata in officina, all'interno di furgoni o nei box dei circuiti
- Può essere fissata su un banco o su una parete
- Il software include tutti i programmi di correzione dello squilibrio con indicazione delle posizioni con pesi adesivi (ALUS), pesi nascosti dietro le razze (SPLIT) e ottimizzazione dello squilibrio
- Può essere utilizzata con supporto orientabile BETA 3070BE/S (optional)

Accessori inclusi:

- Righello flessibile graduato
- Ghiera di serraggio con volantino e 3 coni da Ø 45 + 110 mm

Dati tecnici:

- Alimentazione: 115-230V AC o 12-24V DC
- Potenza massima assorbita: 0.15 kW
- Velocità di equilibratura: 100 rpm
- Incertezza di misura: 1 g
- Larghezza cerchione impostabile: 1.5" + 20" (40+ 510 mm)
- Peso massimo della ruota: max 75 kg

3070BE/K € 3.420,00 1 030700250

3070BE/S

supporto orientabile per equilibratrice portatile elettronica 3070BE

permette il fissaggio a parete o a banco dell'equilibratrice riducendo gli ingombri e gli spazi di installazione



3070BE/S L mm 514 L1 mm 280 € 1.250,00 1 030700201

3070BE/F

flangia universale motocicli Ø 40 mm per 3070BE

utilizzabile sulle ruote con foro centrale passante con Ø da 15 a 35 mm e sulle ruote flangiate con centratura fino a Ø 68 mm



3070BE/F € 1.705,00 1 030700202

3070BE/B

kit di 8 bussole per il centraggio delle ruote dei motocicli per 3070BE

permette di operare sui seguenti Ø:
28 - 25 - 22 - 20 - 19,05 - 17 - 16 - 15



3070BE/B € 1.900,00 1 030700203

3071A

smontagomme manuale per moto da cross e enduro

permette lo smontaggio dei pneumatici in modo semplice e veloce sui campi gara, grazie alla robusta ed ampia struttura realizzata in acciaio zincato garantisce stabilità durante la fase di smontaggio del pneumatico. Per una maggiore praticità di utilizzo è possibile montarlo sul rialzo BETA 3071RS

caratteristiche:
• impugnatura ergonomica in gomma che consente una presa facile e sicura della leva
• dotato di un fermo in gomma per il bloccaggio dell'asta durante il trasporto
• possibilità di montare gomme da cross ed enduro da 17" a 21".

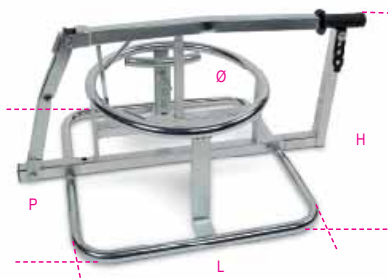

3071A L H P Ø
mm mm mm mm
570 400 850 440 € 526,00 1 030710000

3071B

smontagomme manuale per minimoto e minicross

permette lo smontaggio dei pneumatici in modo semplice e veloce sui campi gara, grazie alla robusta ed ampia struttura realizzata in acciaio zincato garantisce stabilità durante la fase di smontaggio del pneumatico. Per una maggiore praticità di utilizzo è possibile montarlo sul rialzo BETA 3071RS

caratteristiche:
• impugnatura ergonomica in gomma che consente una presa facile e sicura della leva
• possibilità di montare la maggior parte di gomme per minimoto e minicross.



3071B L H P Ø
mm mm mm mm
570 330 650 340 € 492,00 1 030710010

3071RS

rialzo per smontagomme BETA 3071A e 3071B

utilizzato per rialzare gli smontagomme BETA 3071A e 3071B favorendo la procedura di smontaggio, la struttura è realizzata in acciaio zincato con base quadrata per favorire la stabilità.
• dotato di 4 ganci di fissaggio

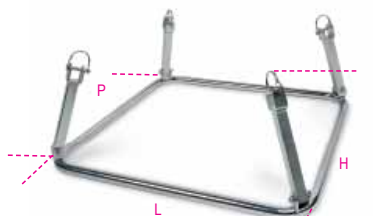

3071RS L H P
mm mm mm
670 275 670 € 229,00 1 030710020

962C

coppia di levagomme per moto da cross, enduro, minimoto e minicross

da utilizzare in abbinamento agli smontagomme BETA 3071A e 3071B



962C L A
mm mm
420 30 € 121,00 1 009620020

3072N

smonta ammortizzatori posteriori e forcelle manuale, da banco, per moto

permette lo smontaggio degli ammortizzatori posteriori moto in totale sicurezza, tramite i bracci regolabili è adatto alla maggior parte degli ammortizzatori posteriori, in alternativa è possibile utilizzare la piastra in dotazione.

caratteristiche:

- adatto all'uso per la maggior parte degli ammortizzatori posteriori moto e forcelle anteriori
- regolabile in altezza in 8 posizioni
- 3 bracci regolabili
- piastra di bloccaggio ammortizzatori
- dotato di cric a pantografo
- dotato di piedini in gomma
- dotato di spina fermo ammortizzatori
- dotato di staffa di trazione

dati tecnici

estensione cric: max 130 mm
estensione bracci: max 55 mm
estensione fermi: max 18 mm
potenza spinta: max 1 ton



3072N L H P
mm mm mm
390 785 390 € 1.189,00 1 030720010

3073

inseritore universale paraoli forcella

per diametri stelo da 35 a 45 mm



3073 € 90,50 1 030730001

30740

chiave per tappi forcelle Ohlins elettroniche

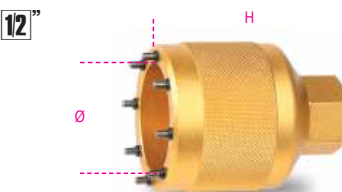

30740 H Ø
mm mm
70,5 50,5 € 106,00 1 030740001

30740/S

chiave per forcelle Sachs
su DUCATI Multistrada

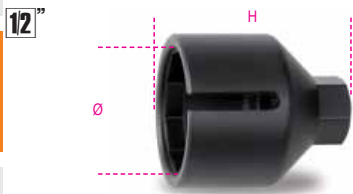

30740/S	H mm	Ø mm	€	1	030740002
	75	65	120,00		

30740/M

chiave per forcelle Marzocchi
per DUCATI 1199 e Hypermotard

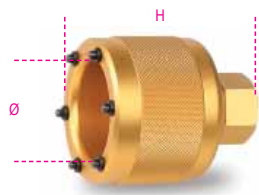

30740/M	H mm	Ø mm	€	1	030740003
	69	55	104,00		

30740/2

chiave per forcelle Ohlins per DUCATI
con impronta ottagonale



30740/2	H mm	Ø mm	€	1	030740004
	45	65	110,00		

3075A

chiave a bussola esagonale
per dadi mozzo ruota

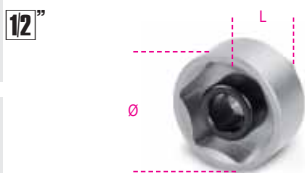

3075A 28	Ø mm	Ø mm	L mm	€	1	030750028
3075A 30	28	38	30	29,50		
	30	40	30	31,50	1	030750030

3075B

chiave a bussola poligonale
per dadi mozzo ruota DUCATI

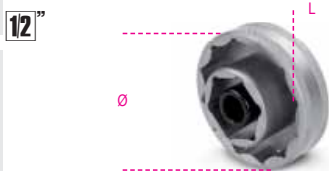

3075B 55	Ø mm	Ø mm	L mm	€	1	030750155
	55	70,7	25	75,50		

3075MV

chiave a bussola poligonale
per dadi mozzo ruota MV AGUSTA



3075MV 56	Ø mm	Ø mm	L mm	€	1	030750156
	56	70,7	30	84,50		

3075/CM

chiave esagonale maschio
multipla per perni ruote



3075/CM	€	1	030750212
12-14-17-19-22-24 mm	42,50		

3075/K10

set chiave universale a testina intercambiabile
e 10 inserti, per serraggio raggi ruote



Misure: 5.2 - 5.4 - 5.6 - 5.8 - 6.0 - 6.2 - 6.4 - 6.6 - 6.8 - 7.0



3075/K10	€	1	030750410
	56,50		

3079/21

oliatore per cavi



Permette una corretta lubrificazione
dei cavi frizione e comando gas
aumentando la scorrevolezza delle guaine e la durata dei cavi.



3079/21	€	1	030790021
	8,60		

3080/C15

kit per smagliatura e ribaditura catene



Diametri 3-4-5 mm e kit regina



3080/C15	€	1	030800015
	377,00		

420x185x60 mm

3080R/CS3

kit di 3 cacciaspina di ricambio per
smagliacatene 3080/C15



diametro 3-4-5 mm



3080R/CS3	€	1	030800503
	58,00		

3081

smagliacatene portatile



Robusto e ripiegabile per facilitarne il trasporto nella borsa da
enduro.
Adatto a catene 415, 420, 428, 520, 525, 530, 532



3081	€	1	030810010
	47,00		

3085

utensile per separazione pistoncini freno



Indicato per pinze freno moto e scooter



3085	€	1	030850010
	104,00		

3091

estrattori con filetto interno per volano



	M	€		
3091/10	24x1,5	21,90	1	030910010
3091/20	26x1,0	23,10	1	030910020
3091/25	27x1,0	23,20	1	030910025
3091/30	28x1,0	23,30	1	030910030
3091/40	30x1,0	31,00	1	030910040
3091/45	30x1,5	31,00	1	030910045
3091/50	32x1,5	34,00	1	030910050
3091/60	33x1,5	35,50	1	030910060
3091/70	35x1,0	50,00	1	030910070
3091/75	35x1,5	50,00	1	030910075
3091/80	38x1,5	54,50	1	030910080

3092

estrattori con filetto esterno per volano



	M	€		
3092/10	18x1,5	11,60	1	030920010
3092/20	19x1,0	13,50	1	030920020
3092/25	27x1,0	14,10	1	030920025
3092/30	27x1,25/20x1	14,20	1	030920030
3092/35	22-26x1,5	14,20	1	030920035
3092/40	25x1,5/22x1	14,20	1	030920040
3092/50	26-28x1,0	14,20	1	030920050
3092/60	28x1,5	14,00	1	030920060

3093/E

attrezzo per bloccaggio volano, campana frizione e pulegge



	€		
3093/E	38,50	1	030930100

3093/U

estrattore multiplo per volano



	€		
3093/U	37,00	1	030930050
M10x1.25R			
M14x1.5R			
M16x1.5R			
M18x1.5R			
M24x1.0R			
M27x1.0L			

3094PA

pannello assistenza moto OFFROAD



struttura in metallo con gambe richiudibili all'interno del telaio, indicato per la sistemazione degli utensili sui campi gara disponibile in 3 colorazioni:

- 3094PA-O Arancione
- 3094PA-G Grigio
- 3094PA-R Rosso

accessori disponibili non inclusi:

- portacarta per rotoli preforati 3200 PR
- portafilacone universale magnetico 2499PF/M

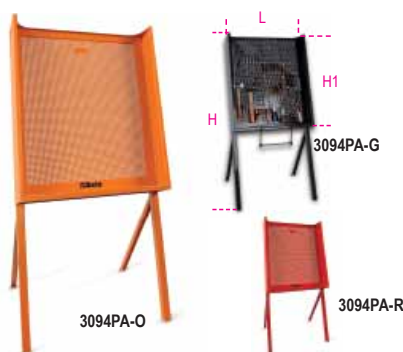

	L	H	H1	€		
	mm	mm	mm			
3094PA-O	750	1555	900	548,00	1	030940101
3094PA-G	750	1555	900	548,00	1	030940102
3094PA-R	750	1555	900	548,00	1	030940103

3095

supporto da banco per motori moto



grazie alle staffe regolabili, le lavorazioni a banco sui motori risultano pratiche ed agevoli



	H	P	L	L1	€		
	mm	mm	mm	mm			
3095	360	460	640	460	618,00	1	030950001

3099E

telo copimoto da esterno resistente ad acqua e polvere protegge la vernice dai graffi, dalla polvere e dai raggi solari



Misure disponibili:

Taglia "M" indicata per moto sportive, naked e scooter di medie dimensioni
Taglia "L" indicata per moto maxi enduro e crossover

		€		
3099E/M	M	87,50	1	030990102
3099E/L	L	107,50	1	030990103

3099T

telo copimoto da interno in tessuto elasticizzato



Protegge la vernice da graffi, dalla polvere e dai raggi solari



Misure disponibili:

Taglia "M" indicata per moto sportive, naked e scooter di medie dimensioni

Taglia "L" indicata per maxi enduro e crossover
Taglia "XL" indicata per super touring

		€		
3099T/M	M	76,00	1	030990202
3099T/L	L	93,00	1	030990203
3099T/XL	XL	112,50	1	030990204





UTENSILI PER BICICLETTA

Beta è da sempre legata al ciclismo. Questa sezione di utensili per biciclette è dedicata ai professionisti del settore, ed è una selezione accurata di prodotti specifici dedicati alla manutenzione delle biciclette e delle e-bike.



Vincitore Tour de France 2020 e 2021



supplier

Partnership 2023

*Collaboratore ufficiale della squadra
di ciclismo EOLO KOMETA*



Partnership 2023



3910

sollevatore per E-Bike



- Portata massima 40kg
- Altezza massima supporto movimento centrale 135cm
- Centra-ruota integrato
- Innovativo sistema di bloccaggio utilizzando il perno passante
- Include bussole adattatori per le maggiori forcelle in circolazione
- Incluso adattatore per attacco forcelle senza perno passante
- Completamente ripiegabile e trasportabile
- Peso del sollevatore 48kg

CE

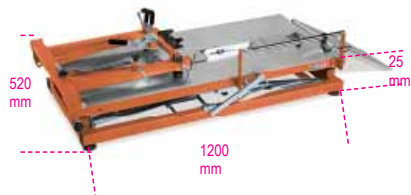

3910 € 3.770,00 1 039100010

3912TP

banco TOP da officina per manutenzione biciclette



- Dotato di supporto per movimento centrale con perno di sicurezza
- Cassetto porta attrezzi montato su guide a sfera 490x365x90 mm
- Centra-ruota integrato
- Innovativo sistema di bloccaggio utilizzando il perno passante



3912TP € 1.560,00 1 039120050

3912PP

banco PRO da officina per manutenzione biciclette



- Dotato di supporto per movimento centrale con perno di sicurezza
- Centra-ruote integrato
- Innovativo sistema di bloccaggio utilizzando il perno passante



3912PP € 850,00 1 039120150

3912TP/A

bussola adattatore per forcelle con perno passante



Per banco 3912TP, 3912PP e 3910



L mm 39 Ø mm 30 Ø1 mm 5 € 20,80 1 039120052

3912TP/C

bussola adattatore universale per forcelle con perno passante e serraggio con chiave esagonale



Per banco 3912TP, 3912PP e 3910



L mm 29 Ø mm 30 € 20,80 1 039120054

3912TP/FOX

bussola adattatore per forcelle FOX®



Per banco 3912TP, 3912PP e 3910



L mm 38 € 20,80 1 039120058

3912TP/ORE

perno adattatore per forcelle senza perno passante



Per banco 3912TP, 3912PP e 3910



L mm 108 € 34,50 1 039120064

3912TP/ROAD

bussola adattatore per forcelle da strada



Per banco 3912TP, 3912PP e 3910



L mm 33 Ø mm 35 € 23,20 1 039120060

3912TP/RS

bussola adattatore per forcelle con perno passante ROCKSHOX®



Per banco 3912TP, 3912PP e 3910



L mm 35 Ø mm 30 € 20,80 1 039120056

3912TP/ST

bussola adattatore per forcelle SUNTOUR



Per banco 3912TP, 3912PP e 3910



L mm 31 Ø mm 30 Ø1 mm 18 € 23,20 1 039120062



3916MMP

morsa monobraccio da officina per manutenzione biciclette

- Morsa girevole di 360° con ganasce flottanti e regolazione micrometrica
- Portata 25Kg
- Vaschetta in plastica porta-attrezzi



3916MMP € 770,00 1 039160150

3918MML

morsa monobraccio di tipo leggero, richiudibile

- Morsa girevole a 360°
- Portata 15kg
- Altezza massima della morsa 150cm



3918MML € 313,00 1 039180010

3921

attrezzo per l'allineamento del forcellino-cambio



L mm 440 A mm 115 A1 mm 165 € 109,00 1 039210010

3923

attrezzo guidalama per taglio reggisella di tipo aerodinamico fino a 80 mm e taglio canotti da 1" a 1.1/2"

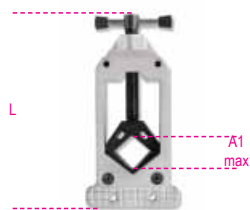

L mm 160 A1 max mm 80 Ø max mm 45 € 51,50 1 039230010

3927

bloccamanubrio



3927 L mm 365 € 31,00 1 039270010

3932U

smagliacatena professionale compatibile con catene da 5 a 11 velocità



L mm 164 L1 mm 115 € 57,00 1 039320011

3935

indicatore usura catena



L mm 120 € 9,75 1 039350010

3937

pinza per falsamaglia



L mm 170 € 25,00 1 039370010

3948

estrattore per pedivelle



Ø mm 14 L mm 79 Ø mm 20 mm 15 € 19,50 1 039480015

3952

chiave conica semplice

- Spessore ridotto



Ø mm	L mm	€	1	039520013
13	205	25,00	2	039520013
14	205	25,00	2	039520014
15	205	25,00	2	039520015
16	205	25,00	2	039520016
17	205	25,00	2	039520017
18	205	25,00	2	039520018
19	205	25,00	2	039520019
20	205	25,50	1	039520020
21	205	25,50	1	039520021
22	205	25,50	1	039520022
24	205	26,50	1	039520024



3952/S7 € 175,00 1 039520207

13-14-15-16

17-18-19 mm

3952/S11 € 278,00 1 039520211

13-14-15-16

17-18-19-20-21-22-24 mm

3953

chiave per pedali



Ø mm 15 L mm 401 € 39,00 1 039530015

3955

chiavi a forchetta per serie sterzo universali



Ø mm	L mm	€	1	039550108
30x32	292	36,00	1	039550108
32x36	319	40,00	1	039550114

3961 3,2

tiraraggi nero 3,2mm



□ mm 3,2 € 14,20 1 039610032

3961 3,3

tiraggi verde 3,3 mm



mm 3,3 € 14,20 1 039610033

3961 3,5

tiraggi rosso 3,5 mm



mm 3,5 € 14,20 1 039610035

3961U

tiraggi professionale 3,2 - 4,0 mm



mm 3,2 - 4,0 € 23,30 1 039610100

3962SH

chiave tiraggi doppia per Shimano®



L mm 132 A1 mm 4,3 A2 mm 4,4 € 18,00 1 039620010

3962MV

chiave tiraggi doppia per Mavic®



L mm 135 A1 mm 4,3 A2 mm 8,4 € 18,70 1 039620020

3963P

chiave speciale per raggi piatti



L mm 129 € 8,50 1 039630010

3964

chiave speciale avvita nippli



• Dotato di molla di ricambio all'interno dell'impugnatura



L mm 170 L1 mm 89 € 21,10 1 039640010

3965

dima per campanatura ruote da 20" a 29"



L mm 680 € 103,00 1 039650010

3965C

centraruote professionale



• Per diametri da 20" a 29"
• Adattatore per assi passanti tra 10 e 20mm

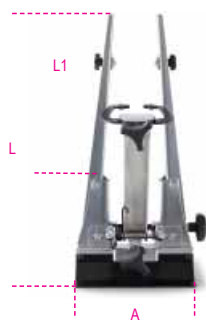

L mm 500 L1 mm 380 A mm 285 € 416,00 1 039650110

3967

chiave frusta smonta-pignoni



• Compatibile fino a cassette da 11 velocità
• Manico in 2PVC
• Adatta anche per ruote a scatto fisso



L mm 289 € 56,50 1 039670010

3969

levagomme



L mm 200 A mm 15,6 € 10,30 1 039690010

3969K3

kit di 3 levagomme, in plastica



L mm 113 € 5,70 1 039690130

3971

chiave per vite in metallo Shimano®



• Adatto per guarniture Shimano® Hollowtech II



N° 8 mm 8 € 12,60 1 039710010

3972

chiave estraattore per movimento centrale



• idoneo per Shimano® Hollowtech II, Campagnolo® Ultra-torque, FSA®, SRAM®



L mm 252 € 24,40 1 039720010

3973PF

estraattore per cuscinetti Press-Fit



• Adatto per diametri interni da 24 e 30mm



L mm 240 € 32,50 1 039730001

3973/1

chiave a bussola estraattore per movimento centrale a 16 tacche



• Idoneo per Shimano® XTR BB93, Dura-Ace® BB9000

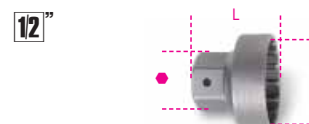

Ø mm 39 mm 24 L mm 34 € 20,90 1 039730010

3973/2

chiave a bussola estrattore per movimento centrale a 16 tacche

• Idoneo per Shimano® BBR60 (Ultegra® 11 velocità)

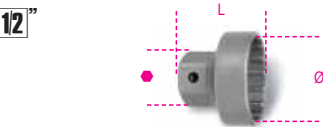

Ø mm	mm	L mm	€	1	039730020
41	24	35	20,90		

3973/3

chiave a bussola estrattore per movimento centrale a 16 tacche

• idoneo per Shimano® Hollowtech II, Campagnolo® Ultra-torque, FSA®, SRAM®

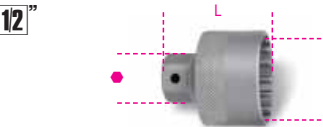

Ø int. mm	mm	L mm	€	1	039730030
46	24	53,5	20,90		

3973/4

chiave a bussola estrattore per movimento centrale a 20 tacche con perno centrale nichelata

• Idoneo per Shimano e ISIS

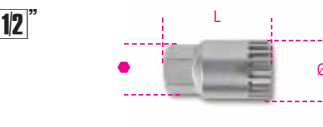

Ø mm	L mm	mm	€	1	039730040
31,5	55	24	13,20		

3975

pressa montaggio serie sterzo

• Adatto per il montaggio delle calotte serie sterzo da 1", 1.1/8", 1.1/4", 1.1/2" e 2"
NOTE: non utilizzabile per calotte "zero stack"



L mm	Ø mm	€	1	039750010
360	16x1	276,00		

3984/1

chiave estrattore per ruote libere BMX a 4 innesti

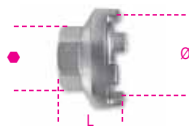

Ø mm	L mm	mm	€	1	039840010
35	25,5	24	15,40		

3984/2

chiave estrattore per ruote libera Shimano®



Ø mm	L mm	mm	€	1	039840020
22,8	26	24	9,75		

3984/3

chiave estrattore per ruote libere Shimano® a cassetta con perno di guida

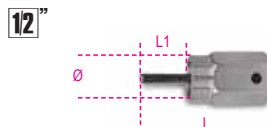

Ø mm	L mm	L1 mm	€	1	039840030
23,5	65	25	16,70		

3984/4

chiave estrattore per ruote libere Campagnolo con perno di guida



Ø mm	L mm	L1 mm	mm	€	1	039840040
23	51	13	24	21,90		

3984/5

chiave estrattore per ruote libere 2 innesti



Ø mm	L mm	mm	€	1	039840050
18,5	38	21	15,40		

3984/6

chiave estrattore per ruote libere 4 innesti

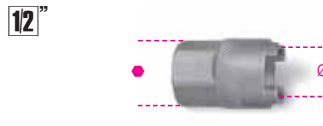

Ø mm	L mm	mm	€	1	039840060
19,5	36	21	15,40		

3991

leva per arretrare pastiglie freni a disco



L mm	A mm	α	€	1	039910010
222	36	7°	36,50		

3992

chiave per raddrizzare dischi freno



L mm	A1 mm	€	1	039920010
234	4 55 2,2	27,50		

2115PI/BIKE-HOME



2115PI/BIKE-HOME	361
------------------	-----

M400



M400	543
MV400	543

M401



M401	543
MV401	543

MM400



MM400	548
MMV400	548

MM401



MM401	548
MMV401	548

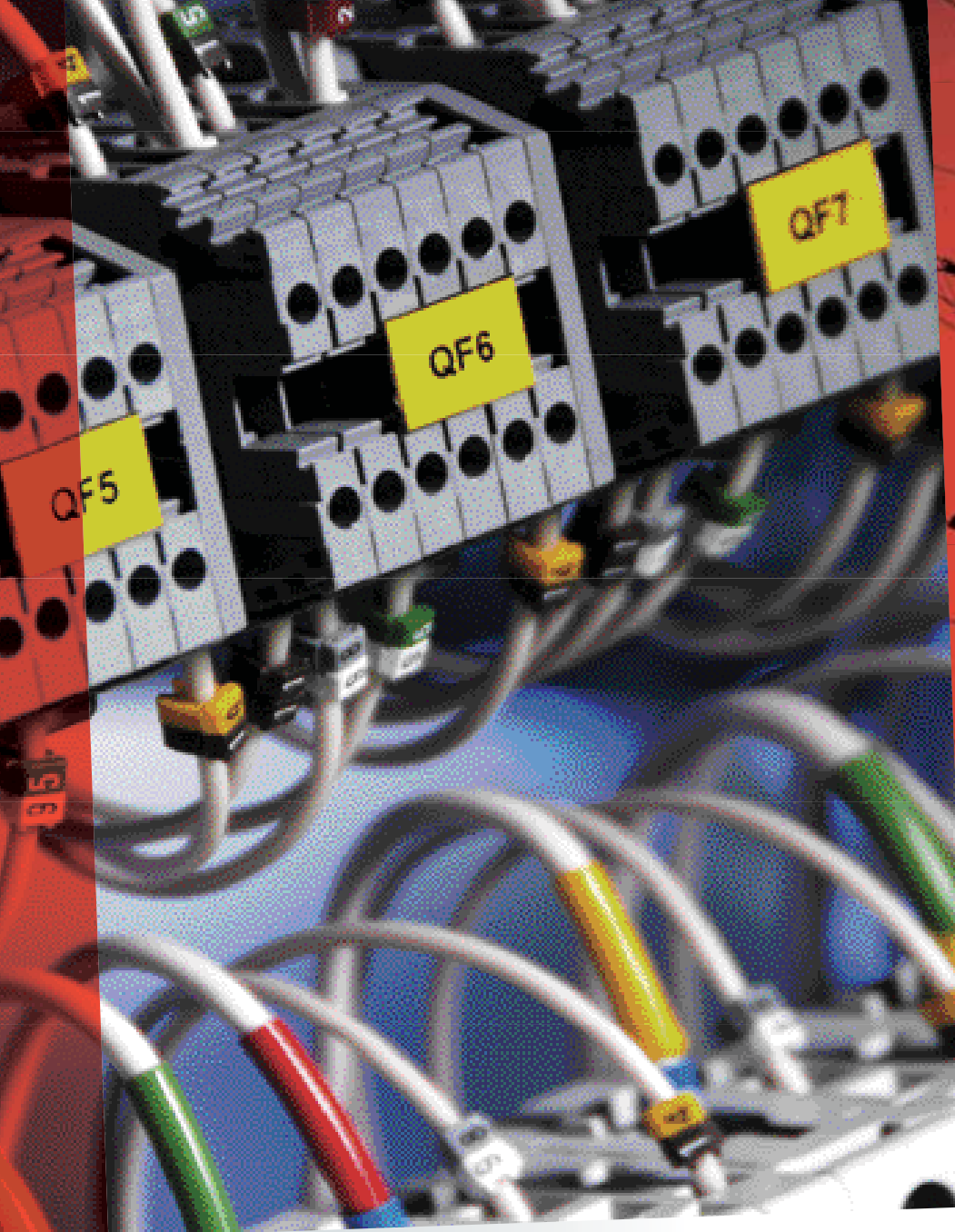

UTENSILI ISOLATI

Gli utensili isolati Beta sono prodotti studiati per garantire la sicurezza di installatori e manutentori elettrici. Tutti gli utensili isolati permettono di operare su impianti in tensione fino a 1000V in corrente alternata e 1500V in corrente continua. Per garantire il massimo livello di qualità e di prestazioni e accertare l'idoneità e la conformità alla norma EN 60900, ogni singolo utensile è sottoposto a un approfondito processo di verifica che comprende: prove di resistenza dell'impugnatura allo sfilamento e alla propagazione della fiamma e prova di tensione applicata a 10000 Volt. Per assortimenti e termoformati vedere le rispettive sezioni.

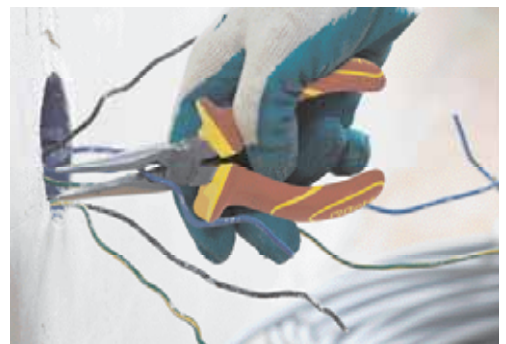

Istituto Italiano del Marchio di Qualità - I



Verband der Elektrotechnik
Elektronik Informationstechnik - D

△ 1000 V

TEST DI SICUREZZA: testati a 10.000 volt per lavorare su impianti a 1.000 volt

Gli utensili ad alto isolamento Beta vengono testati pezzo per pezzo a 10 kV, con l'obiettivo di offrire una qualità assoluta per strumenti di lavoro che devono garantire elevatissimi standard di sicurezza. Permettono infatti di operare su impianti in tensione fino a 1000 V in corrente alternata (1500 V in corrente continua).

NORME DI SICUREZZA:

Nonostante gli accuratissimi controlli in fase di produzione l'operatore deve sempre verificare, prima dell'uso, che non ci siano lacerazioni, modifiche o deterioramenti di qualsiasi tipo dell'impugnatura isolante.

Il mantenimento nel tempo delle caratteristiche dielettriche infatti è strettamente connesso agli stress meccanici, chimici o termici che possono venire imposti all'utensile.

Nel caso di deterioramenti dell'isolante, l'utensile non è da considerare sicuro per l'utilizzo su impianti in tensione. Usare sempre occhiali e guanti isolanti.

CONTROLLI ESEGUITI IN FASE DI PRODUZIONE



Controllo visivo al 100%:

tutti gli utensili devono avere finiture superficiali prive di difetti esteriormente visibili.



Prova d'urto:

dopo un tempo di permanenza di 2 ore a -25°C l'utensile viene colpito per tre volte, (da un peso specifico determinato dalla norma) e non deve svilupparsi alcun danneggiamento dell'impugnatura isolante.



Prova di penetrazione:

viene applicato per due ore un peso di 2 kg sull'impugnatura dell'attrezzo a +70°C, successivamente nella zona sottoposta a pressione meccanica viene applicata una tensione di 5 kV per tre minuti. Non si devono verificare passaggi di corrente.



Prova meccanica:

gli utensili devono soddisfare tutte le prestazioni meccaniche stabilite dalle rispettive norme ISO di prodotto.



Prova di non propagazione della fiamma:

una fiamma viene indirizzata verso l'utensile per 10 secondi, nei 20 secondi successivi la fiamma non deve superare l'altezza di 120 mm.



Controllo dimensionale:

tutte le quote caratteristiche degli utensili devono essere conformi alle specifiche di progetto.



Prova di isolamento elettrico:

dopo un'immersione in acqua per 24 ore all'utensile viene applicata una tensione di 10 kV per 3 minuti. Non si devono verificare dispersioni di corrente superiori a quelle previste dalla norma.



500N

Prova di aderenza:

dopo un tempo di permanenza di 168 ore a +70°C all'utensile viene applicato un carico di 500N per verificare che non si sfili l'impugnatura.



Prova di indelebilità delle marcature:

dopo il test di sfregamento con alcool isopropilico le marcature devono rimanere leggibili.



52MQ

chiavi a forchetta semplici



△ 1000 V

EN 60900

Ø mm	L mm	€	U	U
6	90	34,00	1	000520106
7	96	34,00	1	000520107
8	100	34,00	1	000520108
9	108	34,00	1	000520109
10	110	34,00	1	000520110
11	120	34,00	1	000520111
12	132	36,00	1	000520112
13	140	38,00	1	000520113
14	146	39,00	1	000520114
15	166	40,50	1	000520115
16	156	44,00	1	000520116
17	168	44,00	1	000520117
18	170	45,50	1	000520118
19	176	45,50	1	000520119
21	190	49,50	1	000520121
22	200	49,50	1	000520122
24	225	53,50	1	000520124
27	210	70,00	1	000520127
30	240	73,00	1	000520130
32	240	74,50	1	000520132

89MQ

chiavi poligonali semplici



△ 1000 V

EN 60900

Ø mm	L mm	€	U	U
6	150	43,50	1	000890106
7	155	43,50	1	000890107
8	155	43,50	1	000890108
9	160	43,50	1	000890109
10	170	43,50	1	000890110
11	180	43,50	1	000890111
12	190	47,50	1	000890112
13	195	50,50	1	000890113
14	200	53,50	1	000890114
15	210	54,50	1	000890115
16	216	58,00	1	000890116
17	218	58,00	1	000890117
18	236	62,00	1	000890118
19	240	62,00	1	000890119
21	250	71,00	1	000890121
22	255	71,00	1	000890122
24	280	80,50	1	000890124
27	300	85,50	1	000890127
30	320	100,50	1	000890130
32	340	102,00	1	000890132

110MQ

chiave regolabile a rullino con scala graduata



△ 1000 V

EN 60900

L mm	A max	€	U	U
200	28	87,00	1	001100520
250	30	100,50	1	001100525
300	30	146,50	1	001100530

606MQ/50

chiave dinamometrica a scatto con cricchetto reversibile con sistema di trattenimento della bussola



EN 60900
UNI EN 26789
ISO 6789

Nm	Kgfm	lbf.ft	L1 mm	L mm	g
5÷50	0,5÷5	4÷40	90	375	1130

606MQ/50 € 840,00 1 006060705

850MQ

portainseri magnetico isolato con impugnatura bimatateriale

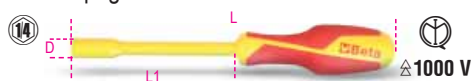

IMQ CSV
EN 60900

L mm	L1 mm	D mm	€	1	008500910
233	125	12.5	25,50	1	008500910

910MQ/B

chiavi a bussola poligonali



EN 60900

mm	L mm	Ø1 mm	Ø mm	€	1	009100616
6	45	14	24	31,00	1	009100616
7	45	15	24	31,00	1	009100617
8	45	16	24	31,00	1	009100618
9	45	17	24	31,00	1	009100619
10	45	19	24	31,00	1	009100620
11	45	20	24	31,00	1	009100621
12	45	24	24	31,00	1	009100622
13	45	24	24	31,00	1	009100623
14	45	25	24	31,00	1	009100624
15	45	27	24	32,50	1	009100625
16	45	27,5	24	32,50	1	009100626
17	45	30	24	33,50	1	009100627
18	45	31	24	33,50	1	009100628
19	45	32	24	33,50	1	009100629

910MQ/PE

chiavi a bussola maschio esagonale



EN 60900

mm	Ø mm	L mm	€	1	009100604
4	24	100	35,00	1	009100604
5	24,5	100	35,00	1	009100605
6	25,0	100	35,00	1	009100606
8	25,0	100	35,00	1	009100608
10	25,5	100	36,00	1	009100610

910MQ/TX

chiavi a bussola maschio per viti con impronta Torx®



EN 60900

Ø mm	L mm	L1 mm	€	1	009100641
T15	23	116	61	44,00	1 009100641
T20	24,5	116	65	44,00	1 009100642
T25	24,5	116	65	44,00	1 009100643
T27	24,5	116	65	44,00	1 009100644
T30	24,5	116	65	45,00	1 009100645
T40	24,5	116	65	45,50	1 009100646

910MQ/XZN

chiavi a bussola maschio a profilo XZN®



EN 60900

Ø mm	L mm	L1 mm	€	1	009100658
M8	24	106	57	41,00	1 009100658
M10	24	106	57	42,50	1 009100660

910MQ/PT

prolunghe pretrate con attacco quadro femmina 3/8"



EN 60900

Nm	L mm	L1 mm	€	1	009100801
12	80	35,5	232,00	1	009100801

910MQ/21

prolunga quadro maschio e femmina 3/8"



EN 60900

L mm	Ø mm	€	1	009100804
140	13,4	56,00	1	009100804

910MQ/22

prolunga quadro maschio e femmina 3/8"



EN 60900

L mm	Ø mm	€	1	009100805
265	13,4	61,00	1	009100805

910MQ/T

quadro maschio 3/8", a T

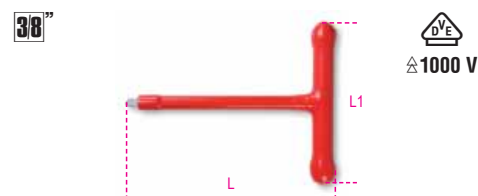

EN 60900

L mm	L1 mm	€	1	009100807
200	165	66,50	1	009100807

910MQ/55

cricchetto reversibile con attacco quadro maschio 3/8"



EN 60900

L mm	D mm	A mm	€	1	009100808
203	41	67	190,00	1	009100808

910MQ/C16

8 chiavi a bussola poligonali
4 chiavi a bussola esagonali maschio
e 4 accessori



EN 60900

910MQ/C16	€	1	009100917
	830,00	1	009100917

○ 910MQ/B	8 - 10 - 11 - 12 - 13 - 14 - 17 - 19 mm
○ 910MQ/PE	4 - 5 - 6 - 8 mm
910MQ/21	125 mm
910MQ/22	250 mm
910MQ/T	
910MQ/55	

914MQ/A

chiavi a bussola esagonali,
con attacco quadro femmina 3/8",
in tecnopolimeri speciali su base poliammidica.

Specifiche per operare sulle batterie delle auto ibride ed
elettriche

Utilizzare con chiave dinamometrica



EN 60900

Ø mm	L mm	Ø1 mm	€	Icon	Icon
8	17,5	45	16,10	2	009140008
10	20,5	45	16,10	2	009140010
13	24	45	16,10	2	009140013
17	30	45	16,10	2	009140017



EN 60900

914MQ-A/S4 € 64,50 1 009140054
8-10-13-17 mm

920MQ/A

chiavi a bussola esagonali



EN 60900

Ø mm	L mm	Ø1 mm	€	Icon	Icon
8	21,5	57	31,00	1	009200238
9	21,5	57	31,00	1	009200239
10	21,5	57	31,00	1	009200240
11	21,5	57	31,00	1	009200241
12	23,0	57	31,00	1	009200242
13	23,0	57	31,00	1	009200243
14	23,0	57	32,00	1	009200244
16	23,0	57	32,50	1	009200246
17	30,0	57	32,50	1	009200247
18	32,0	57	33,50	1	009200248
19	32,2	57	33,50	1	009200249
20	32,0	57	37,50	1	009200250
21	34,0	57	37,50	1	009200251
22	36,0	57	37,50	1	009200252
24	39,0	57	38,50	1	009200254
27	42,0	57	39,00	1	009200257
30	44,0	57	40,50	1	009200260
32	48,0	57	41,50	1	009200262

920MQ/PE

chiavi a bussola
maschio esagonale



EN 60900

Ø mm	L mm	L1 mm	€	Icon	Icon
*4	28,5	94,50	52,00	1	009200264
*5	28,5	94,5	52,00	1	009200265
*6	28,5	94,5	52,00	1	009200266
*8	28,5	94,5	52,00	1	009200268
10	28,5	94,5	54,00	1	009200267
12	28,5	94,5	54,00	1	009200269

920MQ/21

prolunga quadro maschio
e femmina 1/2"



EN 60900

L mm	Ø mm	€	Icon	Icon
135	28	59,50	1	009200804

920MQ/22

prolunga quadro maschio
e femmina 1/2"



EN 60900

L mm	Ø mm	€	Icon	Icon
264	30	67,50	1	009200805

920MQ/T

quadro maschio 1/2", a T



EN 60900

L mm	L1 mm	€	Icon	Icon
200	163	71,00	1	009200807

920MQ/55A

cricchetto reversibile
con attacco quadro maschio 1/2"
con sistema di bloccaggio bussola



EN 60900

L mm	D mm	A mm	€	Icon	Icon
240	50	89	254,00	1	009200809

920MQ/C16

9 chiavi a bussola esagonali
3 chiavi a bussola esagonali maschio
e 4 accessori



EN 60900

€	Icon	Icon
969,00	1	009200917

- 920MQ/A 8 - 10 - 12 - 13 - 14 - 17 - 19 - 22 - 24 mm
- 920MQ/PE 5 - 6 - 8 mm
- 920MQ/21 135 mm
- 920MQ/22 264 mm
- 920MQ/55A
- 920MQ/T

420x280x60 mm - 5,2 kg

943MQ

chiavi a bussola esagonale
con impugnatura



EN 60900

Ø mm	L mm	L1 mm	D mm	€	Icon	Icon
5,5	233	125	12,2	20,20	1	009430235
6	233	125	12,5	20,20	1	009430236
7	240	125	14,3	21,40	1	009430237
8	240	125	15,3	22,00	1	009430238
10	252	125	17,3	22,80	1	009430240
13	252	125	21,3	24,90	1	009430243



943MQ/S6 € 131,50 1 009430250
5,5-6-7-8-10-13 mm

951MQ

chiavi a T maschio esagonale



EN 60900

mm	L mm	L1 mm	€	Icon	Icon
3	120	105	50,50	1	009510703
*4	165	105	52,00	1	009510704
*5	170	105	52,00	1	009510705
*6	168	105	52,00	1	009510706
*8	165	105	53,00	1	009510708
10	200	105	55,00	1	009510710

993MQ

pinzetta a molla a punte curve arrotondate, zigrinate



EN 60900

L mm	€		
147	42,50	1	009930040

994MQ

pinzetta a molla a punte diritte arrotondate, zigrinate



EN 60900

L mm	€		
145	41,50	1	009940040

1010MQ

pinze a becchi tondi lunghi



EN 60900

L mm	L1 mm	€		
160	51,5	51,00	1	010100096

1048MQ

pinze regolabili a cerniera chiusa

• Finitura cromata



EN60900

L mm	A max mm	L1 mm	€		
250	48	39	75,00	1	010480315

1082MQ

tronchesi a taglianti diagonali



EN 60900

L mm	L1 mm	€		
140	20	50,50	1	010820094
160	22	53,00	1	010820096

1084MQ

tronchesi a grande effetto a taglianti diagonali



EN 60900

L mm	L1 mm	€		
200	26	66,50	1	010840100

1088MQ

tronchesi a taglianti frontali



EN 60900

L mm	L1 mm	€		
160	7	63,00	1	010880096

1128MQ

forbici per elettricisti lame in acciaio inossidabile con microdentatura



IEC60900

L mm	L1 mm	€		
145	45	52,50	1	011280101

1132MQ

tagliacavi per cavi flessibili in rame e alluminio



EN 60900

L mm	€		
230	97,00	1	011320193

1142MQ

pinza spellafili



EN 60900

L mm	€		
160	56,00	1	011420096

1150MQ

pinze universali cromate

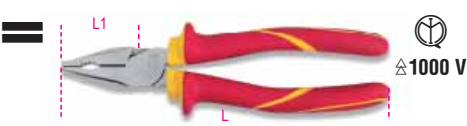

EN 60900

L mm	L1 mm	€		
160	37	48,00	1	011500496
180	39	52,50	1	011500498
200	43	55,00	1	011500500
220	46	60,00	1	011500502

1162MQ

pinze a becchi piatti lunghissimi dritti



EN 60900

L mm	L1 mm	€		
160	56	52,00	1	011620096
200	76	55,00	1	011620100

1164MQ

pinze a becchi piatti lunghissimi piegati



L mm	L1 mm	€		
160	54	54,00	1	011640096
200	76	57,00	1	011640100

1166MQ

pinze a becchi mezzotondi lunghissimi dritti



EN 60900

L mm	L1 mm	€		
160	56	52,00	1	011660096
200	76	55,00	1	011660100

1168MQ

pinze a becchi mezzotondi
lunghissimi piegati



EN 60900

L mm	L1 mm	$\frac{L}{L1}$ mm	€	Icon	Icon
160	50	1,6	54,00	1	011680096
200	70	1,6	57,00	1	011680100

1169MQ/D2

assortimento di 1 pinza universale isolata
e 1 tronchese isolato



1000 V

1169MQ/D2	€	Icon	Icon
1150MQ 180 mm	105,50	1	011690152
1082MQ 160 mm			

1272MQF

giravite per viti con impronta a croce Phillips®

Slim

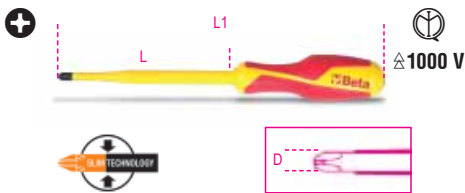

EN60900

PHxDxL mm	L1 mm	€	Icon	Icon
1x4,5x80	187	15,20	3	012720609
2x6x100	218	17,20	3	012720618

1272MQ

giravite per viti con impronta
a croce Phillips®

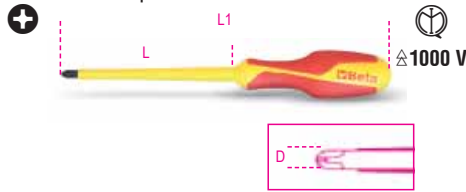

EN 60900

PHxDxL mm	L1 mm	€	Icon	Icon
0x3x60	160	10,20	3	012720703
1x4,5x80	187	12,50	3	012720709
2x6x100	218	14,30	3	012720718
3x8x150	276	18,50	2	012720724
4x10x200	326	22,00	2	012720727



1272MQ/S5	€	Icon	Icon
PH0x3x60-PH1x4,5x80 PH2x6x100-PH3x8x150 PH4x10x200 mm	77,50	1	012720751

1273MQF/D...

serie di 6 giravite slim



1273MQF/D4	€	Icon	Icon
1272MQF 1x4,5x80-2x6x100 mm 1274MQF 0,6x3,5x100-1x5,5x125 mm	60,50	1	012730604

1273MQF/D6	€	Icon	Icon
1272MQF 1x4,5x80-2x6x100 mm 1274MQF 0,6x3,5x100-1x4,5x100 1x5,5x125-1,2x6,5x150 mm	93,50	1	012730606

1273MQ/D6

serie di 6 giravite



1273MQ/D6	€	Icon	Icon
1274MQ 0,5x3x100 -0,8x4x100 1,0x5,5x125 mm 1272MQ PH0x3x60 -PH1x4,5x80 PH2x6x100 mm	73,00	1	012730851

1274MQF

giravite per viti senza testa con intaglio

Slim

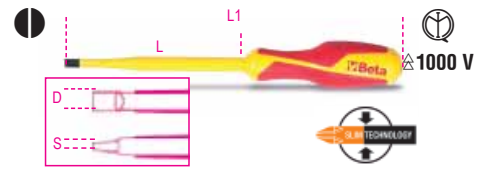

EN60900

SxDxL mm	L1 mm	€	Icon	Icon
0,6x3,5x100	200	13,00	3	012740603
1x4,5x100	205	14,50	3	012740606
1x5,5x125	232	15,30	3	012740609
1,2x6,5x150	268	18,30	3	012740612

1274MQ

giravite per viti senza testa
con intaglio



EN 60900

SxDxL mm	L1 mm	€	Icon	Icon
0,4x2,5x75	175	9,95	3	012740700
0,5x3x100	200	10,40	3	012740703
0,8x4x100	207	12,30	3	012740706
1x5,5x125	232	13,10	3	012740709
1,2x6,5x150	268	15,90	3	012740712
1,2x8x175	301	18,50	2	012740715
1,6x10x200	326	21,90	2	012740718



1274MQ/S6	€	Icon	Icon
0,5x3x100-0,8x4x100 1x5,5x125-1,2x6,5x150 1,2x8x175-1,6x10x200 mm	92,00	1	012740751

1275MQ/C

giravite per viti a croce combinata PH +
intaglio

Slim

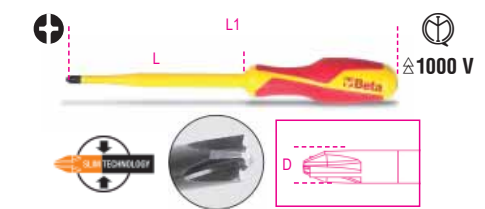

EN60900

Icon	Icon	€	Icon	Icon
PH1+LPP		14,00	2	012750409
PH2+LPP		15,90	2	012750418

1276MQ/C

giravite per viti a croce combinata PZ + intaglio

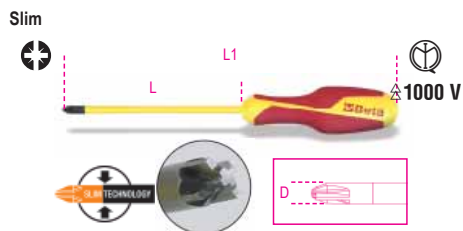

EN 60900

	€		
● PZ1+LPP	13,20	2	012760409
● PZ2+LPP	14,90	2	012760418

1279MQ/F

giravite per viti con impronta a croce Pozidriv®-Supadriv®



EN60900

pz	L mm	L1 mm	€		
1	80	187	14,00	3	012790409
2	100	218	15,90	3	012790418

1279MQ

giravite per viti con impronta a croce Pozidriv®-Supadriv®



EN 60900

PZ	L mm	L1 mm	€		
0	60	160	10,50	3	012790703
1	80	187	12,70	3	012790709
2	100	218	14,60	3	012790718
3	150	276	19,30	2	012790724



1279MQ/S4 PZ 0-1-2-3	€ 57,00	1	012790751
-------------------------	---------	---	-----------

1725MQ

miniseghetto



EN 60900

	L mm	H mm	€		
1725MQ	260	85	97,00	1	017250030

1777MQ/C

coltello spellacavi isolato

per cavi multipolari



EN 60900

	L mm	€		
1777MQ/C	190	39,00	1	017770026

1777MQ/U

coltello spellacavi isolato

per cavi unipolari



EN 60900

	L mm	€		
1777MQ/U	190	35,50	1	017770011

1777RL/U

4 lame di ricambio per cutter 1777MQ/U



1777RL/U	€ 28,00	1	017770021
----------	---------	---	-----------

1995MQ/T

tappeto isolante

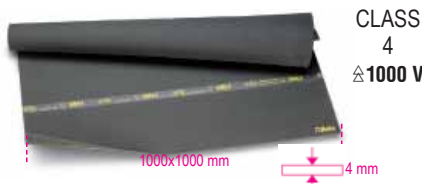

VDE 0303
EN 60243

	LxSxH mm	€		
1995MQ/T	1000x1000	324,00	1	019950030

1995MQ/G1 - G2

guanti isolanti, in lattice

CE EN 60903 CLASS 4 1000 V



EN 60903

	Gr.	L mm	€		
1995MQ/G1	9	410	129,50	1	019950010
1995MQ/G2	10	410	129,50	1	019950013

1996MQ/T

telo isolante

500x500mm

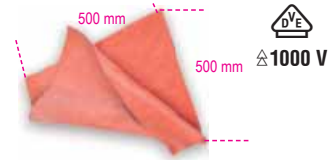

DIN EN 61112

	S mm	€		
1996MQ/T0,5	1.0	98,50	1	019960005

1996MQ/GM

guanti isolanti composti

CE EN 60903 EN 61482 CLASS 4 1000 V



EN 60903
EN 61482

	Gr.	L mm	€		
1996MQ/GM 9	9	410	166,00	1	019960109
1996MQ/GM 10	10	410	166,00	1	019960110

1996SVG

strumento per la verifica pneumatica dei guanti isolati

obbligatoria per la EN90603



1996SVG	€ 380,00	1	019960133
---------	----------	---	-----------

2115P L-MQ32



2115PL-MQ32	362
-------------	-----

2029EM



2029EM	355
--------	-----

5989 VEM



5989 VEM	517
----------	-----



UTENSILI ANTICADUTA

Beta H-SAFE

La gamma di utensili H-SAFE di Beta comprende più di 200 referenze, per le quali è stato progettato individualmente un sistema di trattenimento in grado di resistere alle più severe sollecitazioni meccaniche come garanzia di massima sicurezza.

Anche il confort nell'utilizzo è importante, infatti gli utensili con doppia parte attiva, come la chiave di manovra art. 42, sono allacciati con un cavo che può scorrere lungo tutto il corpo dell'utensile, mentre gli utensili manovrati con torsione, ad esempio il giravite, sono allacciati con anelli a rotazione libera per non indurre attorcigliamenti nel laccio.



Il sistema di trattenimento H-SAFE è stato ideato, testato e prodotto negli stabilimenti Beta. Col sistema di sicurezza H-SAFE di Beta gli utensili sono sempre a portata di mano in modo confortevole e sicuro.

35HS

scalpelli nervati
con sistema anticaduta H-SAFE





L mm	A mm	€		
200	23,0	42,00	1	000354004
250	28,5	53,00	1	000354005

42HS

chiavi combinate
con sistema anticaduta H-SAFE



DIN 3113 UNI-ISO 7738

 mm	L mm	€		
6x6	95	21,70	1	000424506
7x7	105	22,00	1	000424507
8x8	116	22,20	1	000424508
9x9	127	22,90	1	000424509
10x10	137	23,20	1	000424510
11x11	148	23,70	1	000424511
12x12	158	24,00	1	000424512
13x13	169	24,30	1	000424513
14x14	180	25,50	1	000424514
15x15	190	25,50	1	000424515
16x16	201	26,50	1	000424516
17x17	212	27,50	1	000424517
18x18	222	28,00	1	000424518
19x19	233	28,50	1	000424519
20x20	243	30,00	1	000424520
21x21	254	32,00	1	000424521
22x22	264	33,00	1	000424522
23x23	275	34,00	1	000424523
24x24	285	35,50	1	000424524
25x25	296	36,00	1	000424525
26x26	307	37,00	1	000424526
27x27	317	39,50	1	000424527
28x28	328	40,00	1	000424528
29x29	338	44,00	1	000424529
30x30	349	45,50	1	000424530
32x32	370	50,00	1	000424532
34x34	391	82,50	1	000424534
36x36	412	90,00	1	000424536

42HS/AS

chiavi combinate
con sistema anticaduta H-SAFE



 mm	L mm	€		
1/4x1/4	95	23,40	1	000424106
5/16x5/16	116	23,60	1	000424108
3/8x3/8	137	24,90	1	000424110
7/16x7/16	148	25,50	1	000424111
1/2x1/2	169	25,50	1	000424113
9/16x9/16	180	26,00	1	000424114
5/8x5/8	201	28,00	1	000424116
11/16x11/16	212	29,50	1	000424117

Ø"	L mm	€		
3/4x3/4	233	31,50	1	000424119
13/16x13/16	254	35,00	1	000424121
7/8x7/8	264	35,50	1	000424122
15/16x15/16	285	39,00	1	000424124
1x1	296	40,00	1	000424125
1.1/16x1.1/16	317	44,00	1	000424127
1.1/8x1.1/8	338	46,50	1	000424129
1.1/4x1.1/4	370	55,50	1	000424132
1.5/16x1.5/16	391	84,00	1	000424133

55HS

chiavi a forchetta doppie
con sistema anticaduta H-SAFE



UNI-ISO 10102 DIN 3110

Ø mm	L mm	€		
• 6x7	120	17,30	1	000554012
• 8x9	140	17,70	1	000554021
• 10x11	155	18,00	1	000554030
• 12x13	170	19,60	1	000554042
• 14x15	185	20,10	1	000554054
• 16x17	202	21,30	1	000554060
• 18x19	220	22,80	1	000554066
• 20x22	236	24,00	1	000554075
• 21x23	245	25,50	1	000554078
• 22x24	245	27,00	1	000554081
• 24x27	262	29,50	1	000554090
• 30x32	297	37,00	1	000554108
• 34x36	325	83,00	1	000554117

91HS-C

chiavi poligonali curve con leva di manovra
con sistema anticaduta H-SAFE



Ø mm	Ø mm	€		
36	54	101,50	1	000914036
41	62	118,50	1	000914041
46	69	137,50	1	000914046

effettuare il cambio utensile (bussole, chiavi o lame)
esclusivamente a terra

91HS

chiavi poligonali curve
con sistema anticaduta H-SAFE



Ø mm	Ø mm	€		
36	54	202,50	1	000914236
41	62	219,50	1	000914241
46	69	259,00	1	000914246

effettuare il cambio utensile (bussole, chiavi o lame)
esclusivamente a terra

92HS

leve di manovra per art. 91HS
con sistema di anticaduta H-SAFE



L mm	91 mm	Ø mm	€		
610	32÷41	22	101,00	1	000924020
760	46÷55	25	121,50	1	000924030

93HS

chiave per ponteggi
con sistema anticaduta H-SAFE



Ø mm	L mm	€		
21x22	310	58,50	1	000934021

96TBP-HS

chiavi maschio esagonale piegate
con estremità sferica
ed impugnatura di manovra
con sistema anticaduta H-SAFE

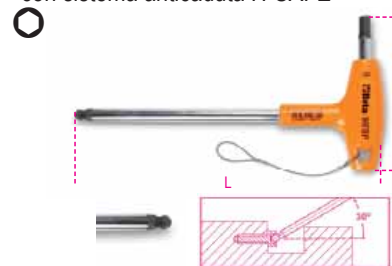

Ø mm	L mm	L1 mm	Ø mm	€		
2,5	153	55	4	27,50	1	000964685
3	153	55	4	28,50	1	000964686
4	179	70	5	29,00	1	000964687
5	200	84	6	29,50	1	000964688
6	221	103	7	32,00	1	000964689
8	255	117	10	37,00	1	000964690
10	285	132	12	40,50	1	000964692

96THS

chiavi maschio esagonale piegate
con impugnatura di manovra
con sistema anticaduta H-SAFE

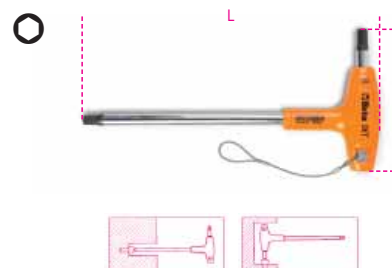

mm	L mm	L1 mm	€		
2,5	153	55	26,50	1	000964935
3	153	55	27,00	1	000964936
4	179	70	27,50	1	000964938
5	200	84	28,00	1	000964940
6	221	103	30,00	1	000964941
8	255	117	35,50	1	000964943
10	285	132	38,50	1	000964945

96THS-AS

chiavi maschio esagonale piegate
con impugnatura di manovra
con sistema anticaduta H-SAFE

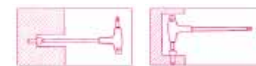

Ø"	L mm	L1 mm	Ø mm	€		
5/32	200	84	6	30,00	1	000964673
3/16	200	84	6	30,00	1	000964674
7/32	221	103	7	33,50	1	000964675
1/4	236	106	8	34,50	1	000964676
5/16	255	117	10	37,00	1	000964678
3/8	285	132	12	41,00	1	000964680

97TTXHS

chiavi maschio piegate
con impugnatura
per viti con impronta Torx®
con sistema anticaduta H-SAFE

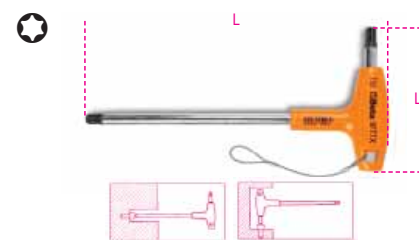

Ø	L mm	L1 mm	€		
T10	179	70	27,00	1	000974710
T15	179	70	27,50	1	000974715
T20	179	70	28,00	1	000974720
T25	179	70	28,50	1	000974725
T30	200	84	33,00	1	000974730
T40	221	103	35,00	1	000974740
T45	236	106	37,50	1	000974745
T50	255	117	46,00	1	000974750

111E-HS

chiavi regolabili a rullino cromate con scala
graduata

con sistema anticaduta H-SAFE

- Rotazione destrorsa del rullino
- Scala millimetrata e in pollici



DIN 3117 ISO 6787

L mm	L"	A max mm	€		
200	8	29	54,00	1	001114120
250	10	34	61,00	1	001114125
300	12	40	75,50	1	001114130
380	15	45	128,50	1	001114138
450	18	54	203,50	1	001114145

142HS

chiavi combinate a cricchetto reversibile

con sistema anticaduta H-SAFE



mm	L mm	€		
8x8	136	34,00	1	001424008
9x9	143	35,00	1	001424009
10x10	159	35,50	1	001424010
11x11	168	36,00	1	001424011
12x12	174	36,50	1	001424012
13x13	180	37,50	1	001424013
14x14	190	38,50	1	001424014
15x15	200	40,00	1	001424015
16x16	216	43,00	1	001424016
17x17	233	44,00	1	001424017
18x18	239	46,50	1	001424018
19x19	248	47,00	1	001424019
21x21	285	56,50	1	001424021
22x22	285	57,50	1	001424022
24x24	325	66,50	1	001424024
27x27	355	88,50	1	001424027
30x30	420	102,00	1	001424030
* 32x32	420	106,00	1	001424032

* modello dritto senza invertitore

360HS

giratubi modello Stillson

con sistema anticaduta H-SAFE



L mm	Ø max " gas	€		
250	1" gas	55,00	1	003604025
350	1 1/2" gas	68,00	1	003604035
450	2" gas	88,00	1	003604045
600	2 1/2" gas	125,50	1	003604060



LC system, sistema di trattamento a doppia sfera. Il rilascio della bussola avviene solo col pulsante

666HS

chiavi dinamometriche a scatto **ZERO-RESET** con cricchetto reversibile per serraggi destrorsi precisione di serraggio $\pm 3\%$

con sistema anticaduta H-SAFE

• Non necessita di essere scaricata



ISO 6789

Nm	■	D mm	A mm	L mm	LC system	g	■
10÷50	3/8	30	33	342	-	680	0,25

666HS/5 281,00 1 006664705

Nm	■	D mm	A mm	L mm	LC system	g	■
20÷100	3/8	30	33	385	-	760	0,25

666HS/10 285,00 1 006664710

Nm	■	D mm	A mm	L mm	LC system	g	■
40÷200	1/2	42	43	471	*	1020	0,5

666HS/20LC 321,00 1 006664721

Nm	■	D mm	A mm	L mm	LC system	g	■
60÷300	1/2	42	43	600	*	1270	1,0

666HS/30LC 360,00 1 006664731

900E-HS/55

cricchetti reversibili

con sistema anticaduta H-SAFE



DIN 3122 - UNI-ISO 3315

L mm	Ø mm	A mm	■	€		
125	25	18	1/4	53,00	1	009004880

910E-HS/55

cricchetti reversibili

con sistema anticaduta H-SAFE



DIN 3122 - UNI-ISO 3315

L mm	Ø mm	A mm	■	€		
200	30	33	3/8	58,50	1	009104880

920E-HS/55LC

cricchetti reversibili "LC System"

con sistema anticaduta H-SAFE



DIN 3122 - UNI-ISO 3315

L mm	Ø mm	A mm	■	€		
275	40	43	1/2	86,50	1	009204860

932HS

chiavi a pipa doppie esagonali-poligonali cromate lucide

con sistema anticaduta H-SAFE



NF E 74.303

mm	Ø mm	L mm	€		
6x6	11,5	110	28,50	1	009324006
7x7	12,5	116	29,50	1	009324007
8x8	13,0	120	31,50	1	009324008
9x9	14,0	125	32,00	1	009324009
10x10	16,5	133	33,00	1	009324010
11x11	17,5	143	34,50	1	009324011
12x12	19,0	148	35,50	1	009324012
13x13	19,5	154	36,00	1	009324013
14x14	21,5	167	38,50	1	009324014
15x15	22,5	182	39,00	1	009324015
16x16	24,5	193	40,00	1	009324016
17x17	26,0	198	41,00	1	009324017
18x18	26,5	215	44,00	1	009324018
19x19	29,0	220	46,50	1	009324019

1032HS

pinze a becchi diritti per anelli elastici di sicurezza, per fori manici ricoperti in PVC

con sistema anticaduta H-SAFE



UNI 7914 DIN 5256

L mm	Ø mm	Ø1 mm	A mm	€		
140x1,3	12÷25	1,3	20	39,50	1	010324014
180	19÷60	1,9	21	42,00	1	010324017

Beta

1034HS

pinze a becchi piegati a 90°
per anelli elastici di sicurezza, per fori
manici ricoperti in PVC

con sistema anticaduta H-SAFE



UNI 7914 DIN 5256

L	Ø	Ø1	A	€	Icon	Icon
mm	mm	mm	mm			
170	19=60	1,9	21	44,50	1	010344017

1036HS

pinze a becchi dritti
per anelli elastici di sicurezza per alberi
manici ricoperti in PVC

con sistema anticaduta H-SAFE



UNI 7915 DIN 5254

L	Ø	Ø1	A	€	Icon	Icon
mm	mm	mm	mm			
140x1,3	10=25	1,3	20	42,00	1	010364014
175	19=60	1,9	21	43,00	1	010364017

1038HS

pinze a becchi piegati a 90°
per anelli elastici di sicurezza per alberi
manici ricoperti in PVC

con sistema anticaduta H-SAFE



UNI 7915 DIN 5254

L	Ø	Ø1	A	€	Icon	Icon
mm	mm	mm	mm			
175	19=60	-	21	46,00	1	010384017

1048BM-HS

pinza regolabile a cerniera chiusa,
impugnatura bimatériauale

con sistema anticaduta H-SAFE

· modello a nove posizioni

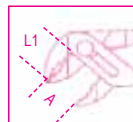

ISO 8976

L	A max	L1	g	€	Icon	Icon
mm	mm	mm				
250	48	39	460	66,00	1	010484215

1052HS

pinze regolabili autobloccanti
ganasce concave

con sistema anticaduta H-SAFE



L	A	A1 max	S	€	Icon	Icon
mm	mm	mm	mm			
240	72	42	10,0	54,50	1	010524024

1082BM-HS

tronchesi a taglienti diagonali
impugnatura bimatériauale

con sistema anticaduta H-SAFE



UNI/ISO 5749

L	L1	mm	A	€	Icon	Icon
mm	mm	mm	mm			
160	22	1,6	28,0	53,50	1	010824036

1088BM-HS

tronchesi a grande effetto
a taglienti frontali
impugnatura bimatériauale

con sistema anticaduta H-SAFE

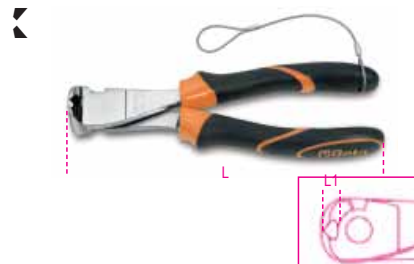

UNI/ISO 5748

L	L1	mm	A	€	Icon	Icon
mm	mm	mm	mm			
160	9	1,6	28,0	61,50	1	010884036
200	11	2,0	36,0	77,00	1	010884040

1128BAX-HS

forbici per elettricisti a **doppio effetto**,
con profili a fresa in acciaio inossidabile
rivestito in DLC

con sistema anticaduta H-SAFE

taglio a doppio effetto: attraverso una speciale camma sul fulcro si ottiene uno scorrimento longitudinale delle lame che, nella fase di chiusura, ne aumenta la potenza di taglio.

profilo e fresa: studiate per allargare fori su plastica da 13 a 25 mm.

rivestimento DLC: Il DLC (diamond-like carbon) è un rivestimento innovativo a base di carbonio: l'elevata durezza ed il basso coefficiente d'attrito nascono dalla simultanea presenza di carbonio depositato sulla superficie in forma di grafite e diamante.

- alta durezza superficiale delle lame (resistenza all'abrasione e mantenimento dell'affilatura nel tempo)
- basso coefficiente di attrito (scorrevolezza e potenza di taglio)
- perno eccentrico antiallentamento
- manici ampi con gole strozzatubi



L	L1	mm²	€	Icon	Icon
mm	mm				
150	50	50	51,00	1	011284088



1132BM-HS

tagliacavi
impugnatura bimatereale
per cavi isolati in rame e alluminio

con sistema anticaduta H-SAFE



UNI 8791

L	mm	A	B	€	1	011324143
230	18	37	12,5	93,50		

1150BM-HS

pinze universali a grande effetto,
cromate,
impugnatura bimatereale

con sistema anticaduta H-SAFE



ISO 5746

L	L1	mm	A	€	1	011504146
160	42	1,6	22,0	46,50		
180	46	1,8	25,0	48,50		
200	50	2,0	27,0	53,50		

1166BM-HS

pinze a becchi mezzotondi lunghissimi
diritti zigrinati
impugnatura bimatereale

con sistema anticaduta H-SAFE



ISO 5745

L	L1	mm	A	€	1	011664040
200	76	1,6	22,0	55,00		

1168BM-HS

pinze a becchi mezzotondi lunghissimi
piegati zigrinati
impugnatura bimatereale

con sistema anticaduta H-SAFE



ISO 5745

L	L1	mm	A	€	1	011684040
200	70	1,6	22,0	58,00		

1290HS

giravite per viti a testa con intaglio

con sistema anticaduta H-SAFE

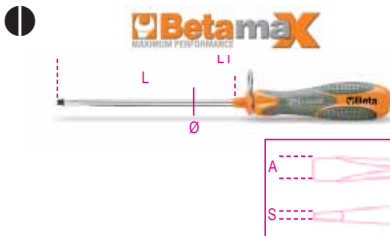

ISO 2380

SxAxL	L1	Ø	€	1	012904006
0,4x2,5x75	171	2,5	19,10		
0,5x3x100	196	3,0	19,80		
0,6x3,5x100	196	3,5	21,00		
0,8x4x100	196	4,0	20,60		
0,8x4x150	246	4,0	22,00		
1x5,5x150	259	5,0	24,50		
1,2x6,5x150	270	6,0	26,00		
1,2x8x150	282	7,0	28,50		
1,6x10x200	332	8,0	34,00		

1292HS

giravite per viti
con impronta a croce Phillips® H-SAFE

con sistema anticaduta H-SAFE



UNI/ISO 8764

PHxDxL	L1	€	1	012924006
0x3x100	196	20,00		
1x4,5x120	229	22,10		
2x6x150	270	26,50		
3x8x150	282	30,50		

1294HS

giravite per viti senza testa
con intaglio

con sistema anticaduta H-SAFE



SxDxL	L1	€	1	012944003
0,5x2,5x60	156	18,60		
0,6x3x75	171	18,80		
0,8x4x100	196	20,70		
1x5x125	234	24,10		

1299HS

giravite per viti con impronta
a croce Pozidriv®-Supadriv®

con sistema anticaduta H-SAFE



UNI/ISO 8764

PZ	L	L1	€	1	012994000
0	60	156	20,90		
1	80	189	23,40		
2	100	220	28,50		
3	150	282	36,00		

1370T-HS

martelli tipo tedesco
per meccanici
manico in fibra

con sistema anticaduta H-SAFE



g	A	L	L1	€	1	013704630
300	23	300	105	39,50		
500	27	320	118	42,50		
1000	36	360	135	53,50		



1370FT-HS

martelli tipo francese per meccanici,
manico in fibra

con sistema anticaduta H-SAFE



A	L	L1	B	€		
mm	mm	mm	mm		1	
28	280	86	22	54,50	1	013704528
30	280	92	24	55,00	1	013704530
36	300	104	29	65,00	1	013704536

1390HS

mazzuole con battenti intercambiabili
in materiale plastico
manico in legno

con sistema anticaduta H-SAFE



UNI 7784

D	L	L1	€		
mm	mm	mm		1	
35	310	95	50,00	1	013904035
45	320	107	71,00	1	013904045

1392HS

mazzuole antirimbalo
con battenti intercambiabili
in materiale plastico
manico in acciaio

con sistema anticaduta H-SAFE



D	L	L1	€		
mm	mm	mm		1	
35	305	115	72,50	1	013924035
40	310	125	81,00	1	013924040
50	325	135	94,50	1	013924050
60	385	155	137,50	1	013924060

1602A-HS

pinza per capicorda preisolati
modello standard

con sistema anticaduta H-SAFE



L	A	B	€		
mm	mm	mm		1	
0÷6	220	42	77,00	1	016024005

1682HS

righe flessibili graduate
in acciaio inossidabile

con sistema anticaduta H-SAFE

- doppia scala millimetrata
- antiriflesso



L	H	±	€		
mm	mm	mm		1	
200	13	0,5	17,30	1	016824020
300	13	0,5	19,60	1	016824030

1692HS

flessometri
cassa bimerale in ABS antiurto
nastro in acciaio
classe di precisione II

con sistema anticaduta H-SAFE

CE



L	S	€		
m	mm		1	
3	16	23,40	1	016924053
5	19	27,50	1	016924055

1708HS/20

spessimetri

con sistema anticaduta H-SAFE

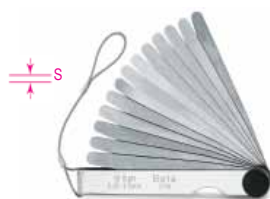

S	S	L	€		
mm	mm	mm		1	
0,05÷1,0	0,002÷0,040	105	25,50	1	017084020

1727HS

seghetto tipo pesante

con sistema anticaduta H-SAFE

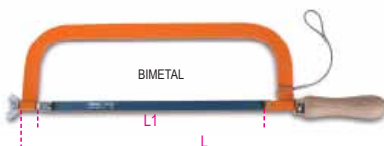

L	L1	€		
mm	mm		1	
515	300	35,50	1	017274001

1743HS

pinza per fascette in Nylon

con sistema anticaduta H-SAFE

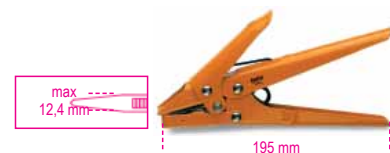

L	A	B	€		
mm	mm	mm		1	
195	85	17	73,50	1	017434001

1750HS

compressori a leva per grasso

con sistema anticaduta H-SAFE



1 g. 550 bar Max

cc	L	€		
mm	mm		1	
500	380	62,00	1	017504500

1760BHS

multimetro digitale

con sistema anticaduta H-SAFE



PARAMETRI RILEVABILI
Tensione DC: 200 mV-2/20/200/1000V
Tensione AC: 2-20/200/700V
Corrente DC: 2/20/200 mA-20 A
Corrente AC: 2/200 mA- 20 A
Resistenza: 200Ω - 2/20/200 kΩ - 2/20 MΩ
Capacità: 2/20/200 nF - 2/200 μF
Temperatura: -20° + 1000°C/ -4 °F ~ +2000°F
Frequenza: 20kHz
Alimentazione: 1 batteria da 9V (inclusa)

L	€		
mm		1	
1760BHS	244,50	1	017604012

1772H-HS

cutter a lama retrattile di sicurezza,
fornito con 2 lame

con sistema anticaduta H-SAFE



L mm	A mm	€	1	017724029
170	18	32,00		

1778SOS-HS

coltello soccorso auto
con funzione martello frangicristallo
e tagliacinture di sicurezza
• in astuccio

con sistema anticaduta H-SAFE



L mm	A mm	L1 mm	€	1	017784080
205	25	85	51,00		

8871

cinturone di sicurezza
con fibbia metallica a doppia chiusura,
per il collegamento degli utensili H-SAFE



	L cm min-max	€	1	
8871 70	70-100	144,50		1 088710070
8871 100	100-135	156,50		1 088710100

8872A

passante fisso

• Per cinturone 8871



8872A 50	€	1	088720050
	25,50		

8872AS

passante apribile a strappo

• Per cinturone 8871



8872AS 25	D mm	€	1	088720525
	25	23,40		

8873

Sacca portautensili
con chiusura autoserrante e zip

• Per cinturone 8871



8873 230	€	1	088730230
	122,50		

8877

laccio di collegamento ammortizzato

• MAX 2.7 kg



8877 80	L cm min+max	DxL mm	€	1	088770080
	70-110	40x80	31,50		

8877M

laccio di collegamento ammortizzato

• Con giunto anti-attorcigliamento
• MAX 2.7 kg



	L cm min+max	DxL mm	€	1	088770510
8877M	20-140	30x60	56,00		

8879

polsiera a strappo

• MAX 2.7 kg



8879	D mm	€	1	088790025
	30	36,00		

8880

laccio di collegamento non ammortizzato

• Con giunto
anti-attorcigliamento



8880 30	L Cm	D mm	€	1	088800030
	30	10	28,00		

8883

sacca portautensili

• In nylon 840 antiabrasione
• MAX 20 kg
• Moschettone per bloccare
la zip a fine corsa
• 6 lacci trattieni-utensile
• Tasca interna



8883	DxH cm	€	1	088830030
	30x40	296,00		





UTENSILI INOX



L'**acciaio inossidabile** è un acciaio legato con una elevata percentuale di cromo. Il cromo crea una patina superficiale di ossido che protegge il metallo e che si riforma immediatamente in caso di danneggiamento chimico o meccanico.

Sfruttando questa straordinaria caratteristica, **Beta Utensili** ha ideato la linea **Beta Inox**, una gamma di utensili che garantiscono elevata resistenza alla corrosione e spiccate caratteristiche di **igienicità e bassa ritentività batterica**. Gli utensili realizzati in acciaio inossidabile, infatti, **si sporcano meno e si puliscono meglio** di quelli realizzati con altri materiali, e possono essere **sterilizzati in autoclave a 121°C**.

Gli utensili **Beta Inox** possono essere utilizzati in **ambienti critici**, ovvero zone e aree in cui non è ammesso il minimo livello di contaminazione.

Campi di applicazione:

- Industria alimentare
- Produzione farmaceutica CLASSE C
- Laboratori biotecnologici e biomedici
- Applicazioni nucleari

Gli utensili **Beta Inox** evitano fenomeni di contaminazione ferrosa, con conseguente presenza di **ruggine impropria**. Quando si utilizzano utensili realizzati con comuni acciai al carbonio su viti, dadi o superfici in acciaio inossidabile, dagli utensili si possono disperdere particelle di ferro che generano problemi estetici (**macchie di ruggine**) che, se trascurati, innescano processi di corrosione localizzati. L'utilizzo di



INOX + NO INOX
= RUGGINE



INOX + INOX
= NO RUGGINE

utensili in acciaio inossidabile esclude completamente la diffusione di particelle inquinanti.

Campi di applicazione:

- Cantieri navali
- Edilizia
- Applicazioni offshore
- Impianti solari
- Industria automobilistica

Caratteristiche meccaniche

Gli utensili Beta sono realizzati in **acciaio AISI 420**, magnetico e con elevate caratteristiche meccaniche che permettono di costruire utensili che raggiungono prestazioni ampiamente superiori ai valori di norma e comparabili ai normali utensili Beta. L'ergonomia e il design sono gli stessi degli utensili Beta, conosciuti e apprezzati dagli utilizzatori professionali da più di 80 anni. I contenitori sono realizzati in **acciaio AISI 304**, che ha elevate caratteristiche di formabilità a freddo e una resistenza alla corrosione ancora maggiore.

Riciclabilità

L'acciaio inossidabile è **riciclabile al 100%**. Anche questa è una caratteristica importante.



Marchio per i prodotti in acciaio inossidabile. È un marchio rilasciato dal Centro Inox – Associazione per lo studio e lo sviluppo degli acciai inossidabili, che caratterizza i prodotti realizzati in acciaio inossidabile.

34INOX

scalpelli piatti,
in acciaio inossidabile



L mm	A mm	Ø mm	€	📦	📄
160	18	18	44,00	1	000340318
200	20	20	65,00	1	000340320

39INOX

cunei,
in acciaio inossidabile



L mm	A mm	S mm	€	📦	📄
100	50	10	30,50	1	000390310
150	50	13	55,00	1	000390315
200	40	40	161,00	1	000390320

42INOX

chiavi combinate,
in acciaio inossidabile



DIN 3113 - UNI ISO 7738

mm	L mm	€	📦	📄
6x6	95	15,30	2	000420306
7x7	105	15,90	2	000420307
8x8	116	16,00	2	000420308
9x9	127	17,20	2	000420309
10x10	137	18,20	2	000420310
11x11	148	19,70	2	000420311
12x12	158	20,50	2	000420312
13x13	169	20,70	2	000420313
14x14	180	21,50	2	000420314
15x15	190	22,10	2	000420315
16x16	201	22,70	2	000420316
17x17	212	25,50	2	000420317
18x18	222	27,50	2	000420318
19x19	233	29,50	2	000420319
21x21	254	36,00	1	000420321
22x22	264	37,00	1	000420322
24x24	285	41,00	1	000420324
27x27	290	119,00	1	000420327
30x30	320	145,50	1	000420330
32x32	340	158,00	1	000420332
36x36	360	221,50	1	000420336
38x38	430	237,00	1	000420338
41x41	430	278,00	1	000420341
46x46	480	319,00	1	000420343
50x50	520	344,00	1	000420345
55x55	560	372,00	1	000420347
60x60	595	414,00	1	000420350



42INOX/S11	231,50	1	000420391
6-8-10-11-12-13-14-15-16-17-19 mm			



42INOX/SC9	202,50	1	000420387
8-10-11-12-13-14-15-17-19 mm			
42INOX/SCV9	10,60	1	000420303

42INOX-AS

chiavi combinate,
in acciaio inossidabile



"	L mm	€	📦	📄
1/4x1/4	95	18,40	1	000420356
5/16x5/16	116	18,60	1	000420358
3/8x3/8	137	22,30	1	000420360
7/16x7/16	148	24,10	1	000420361
1/2x1/2	169	24,80	1	000420363
9/16x9/16	180	26,50	1	000420364
5/8x5/8	201	28,00	1	000420366
11/16x11/16	212	32,50	1	000420367
3/4x3/4	233	35,50	1	000420369
13/16x13/16	254	41,00	1	000420371
7/8x7/8	264	43,00	1	000420372
15/16x15/16	285	48,50	1	000420373



42INOX-AS/S9	230,50	1	000420396
1/4-5/16-3/8-7/16-1/2-9/16-5/8-11/16-3/4			



96BPINOX

chiavi maschio esagonale piegate con
estremità sferica,
in acciaio inossidabile



mm	L mm	L1 mm	g	€	📦	📄
2	91	22	4	5,40	4	000961441
2,5	91	22	6	5,40	4	000961442
3	101	24	11	5,70	4	000961443
4	112	29	19	6,40	4	000961444
5	131	33	32	7,60	4	000961445
6	154	36	51	8,35	4	000961446
7	164	40	65	10,90	2	000961447
8	175	44	116	13,30	2	000961448
10	197	51	189	16,50	2	000961450



96BPINOX/B6	53,00	1	000961455
2,5-3-4-5-6-8 mm			
96BPINOX/B9	86,00	1	000961456
2-2,5-3-4-5-6-7-8-10 mm			
96BPINOX/BV	6,50	1	000961459

96BPINOX-AS

chiavi maschio esagonale piegate con
estremità sferica,
in acciaio inossidabile

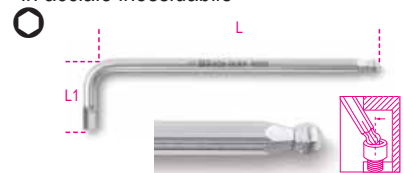

"	L mm	L1 mm	g	€	📦	📄
5/64	91	22	5,5	6,95	4	000961989
3/32	91	22	5,3	6,95	4	000961990
7/64	101	24	10,5	7,45	4	000961991
1/8	101	24	10,7	7,45	4	000961992
9/64	112	29	18,7	8,15	4	000961993
5/32	112	29	18,7	8,15	4	000961994
3/16	131	33	31,5	10,90	2	000961995
7/32	154	36	50,0	11,30	2	000961996
1/4	164	40	70,0	12,00	2	000961997
5/16	175	44	115,0	14,20	2	000961998
3/8	197	51	186,5	17,60	2	000961999



96BPINOX-AS/B8	84,50	1	000962000
5/64-3/32-1/8-5/32-3/16-7/32-1/4-5/16			
96BPINOX/BV	6,50	1	000961459

96TINOX

chiavi maschio esagonale piegate
con impugnatura di manovra,
in acciaio inossidabile

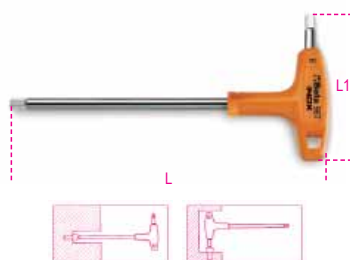

mm	L mm	L1 mm	€		
2,5	153	55	13,00	2	000961935
3	153	55	13,50	2	000961936
4	179	70	14,80	2	000961938
5	200	84	16,40	2	000961940
6	221	95	17,90	2	000961941
7	236	106	20,60	2	000961942
8	255	117	24,40	2	000961943
10	285	132	31,50	2	000961944



	€		
96TINOX/S5 2,5-3-4-5-6 mm	75,50	1	000961952
96TINOX/S8 2,5-3-4-5- 6-7-8-10 mm	152,00	1	000961954

96TINOX-AS

chiavi maschio esagonale piegate
con impugnatura di manovra,
in acciaio inossidabile

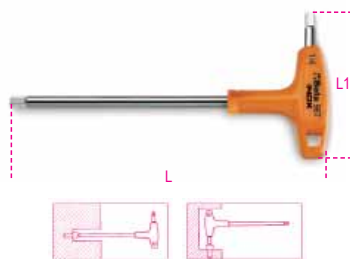

"	L mm	L1 mm	Ø mm	€		
3/32	153	55	3	14,20	2	000961861
7/64	153	55	4	14,50	2	000961862
1/8	179	70	4	16,30	2	000961863
9/64	179	70	5	16,60	2	000961864
5/32	200	84	6	17,50	2	000961865
3/16	200	84	6	18,80	2	000961866
7/32	221	103	7	21,90	2	000961867
1/4	236	106	8	22,90	2	000961868
5/16	255	117	10	28,00	2	000961869
3/8	285	132	12	30,50	2	000961870



	€		
96TINOX-AS/S7 3/32-1/8-5/32-3/16- 7/32-1/4-5/16	139,50	1	000961877

111INOX

chiavi regolabili a rullino,
in acciaio inossidabile



DIN 3117 - ISO 6787

L mm	L" "	A max mm	A1 mm	€		
150	6	18	45	94,00	1	001110315
200	8	24	58	122,00	1	001110320
250	10	30	70	152,00	1	001110325

362INOX

giratubi modello americano,
in acciaio inossidabile



L mm	Ø max mm	€		
300	58	205,50	1	003620430

920INOX-A

chiavi a bussola a mano
bocca esagonale
in acciaio inossidabile



12"



DIN 3124 - UNI ISO 2725

Ø mm	Ø mm	A mm	L mm	€		
8	15	10	40	32,50	2	009203008
9	16	10	40	34,50	2	009203009
10	17	10	40	36,00	2	009203010
11	18	11	40	38,50	2	009203011
12	19	11	40	41,00	2	009203012
13	20	11	40	43,50	2	009203013
14	21	11	40	45,50	2	009203014
15	23	11	40	48,00	2	009203015
16	24	11	40	50,00	2	009203016
17	25	11	40	51,50	2	009203017
18	26	13	42	53,50	2	009203018
19	28	13	42	55,50	2	009203019
20	29	13	42	59,00	1	009203020
21	30	13	43	60,00	1	009203021
22	31	15	43	60,50	1	009203022
24	34	15	43	70,50	1	009203024
27	38	18	46	86,50	1	009203027
30	42	20	46	102,50	1	009203030
32	44	20	46	116,00	1	009203032

920/55INOX

cricchetto reversibile
con attacco quadro maschio 1/2"
meccanismo a 72 denti
in acciaio inossidabile



12"



L mm	Ø mm	A mm	€		
264	40	43	249,50	1	009203882

920/R55INOX



12"



	€		
920/R55 INOX	88,50	1	009203879

1048INOX

pinza regolabile cerniera chiusa
in acciaio inossidabile
• modello a sette posizioni



L mm	A max mm	L1 mm	€		
250	33	33	159,00	1	010480325

1082INOX

tronchesi a taglianti diagonali,
in acciaio inossidabile



L mm	L1 mm	mm	€		
150	20,0	1,6	115,50	1	010820350

1150INOX

Pinza universale a grande effetto
in acciaio inossidabile

perno decentrato
cassetta aperta



L mm	L1 mm	€		
180	39	112,50	1	011500518



1153INOX

pinza regolabile a due posizioni,
in acciaio inossidabile



L mm	L1 mm	€	📦	📄
150	26	110,00	1	011530315

1290INOX

giravite per viti a testa con intaglio
in acciaio inossidabile

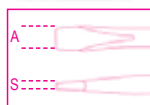

ISO 2380

SxAxL mm	L1 mm	Ø mm	€	📦	📄
0,4x2,5x50	146	2.5	9,50	4	012900403
0,5x3x75	171	3.0	9,75	4	012900409
0,8x4x100	196	4.0	10,10	4	012900430
1,0x5,5x150	259	5.0	12,90	4	012900442
1,2x6,5x150	270	6.0	14,80	4	012900451

1292INOX

giravite per viti con impronta a croce Phillips®,
in acciaio inossidabile



ISO 8764

PHxDxL mm	L1 mm	€	📦	📄
0x3x60	156	8,85	4	012920403
1x4,5x80	189	10,50	4	012920409
2x6x100	220	12,90	4	012920418

1293INOX/D8

serie giravite
in acciaio inossidabile



1293INOX/D8	€	📦	📄
1290INOX	89,50	1	012930408
1292INOX			

1370INOX

martello tipo tedesco
per meccanici
in acciaio inossidabile



g	A mm	L mm	L1 mm	€	📦	📄
500	25	240	101	99,50	1	013700375

1377INOX

martelli con testa tonda
e penna sferica
per caldaia e lattonieri
in acciaio inossidabile



g	L mm	L1 mm	€	📦	📄
230	220	82	58,00	1	013770623
340	220	90	83,50	1	013770634

1730INOX

spatola universale,
in acciaio inossidabile



A mm	L mm	€	📦	📄
50	200	51,00	1	017300450

C20TSS

cestello estendibile a cinque scomparti
in acciaio inossidabile **AISI 304**



C20TSS	€	📦	📄
	310,00	1	021203001

📏: 450x200x210 mm - 📊 4kg

T23



T23	549
TV23	549

T99



T99	552
TV99	552

T228



T228	556
TV180	555-556

Beta

Beta

C04TSS-7

cassettiera mobile con sette cassetti
in acciaio inossidabile, con ruote antitraccia

Caratteristiche principali:

- Sette cassetti da 570 x 410 mm montati su guide telescopiche a sfera;
- 6 cassetti altezza 83 mm;
- 1 cassetto altezza 170 mm;
- Quattro ruote antitraccia con nucleo in acciaio inossidabile Ø 125mm
- 2 fisse e 2 girevoli (due con freno);
- Serratura frontale centralizzata;
- Struttura interamente in acciaio inossidabile AISI 304
- Ruote, supporti, sfere, interno dei cassetti e relative guide in acciaio inossidabile
- Maniglia cassetti in alluminio

63 kg

Beta
INOX
STAINLESS STEEL



700
kg

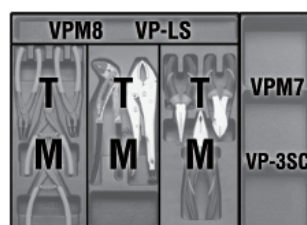

h	max
83 mm	25 kg
170 mm	30 kg

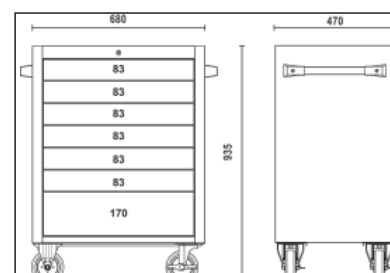
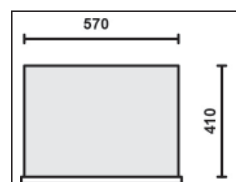

C04TSS/7

€ 2.770,00 1 024003077



RAME-BERILLIO Cu-Be

Gli utensili Antiscintilla **Beta** sono specifici per operare in assoluta sicurezza in ambienti a potenziale rischio di esplosioni, con presenza di liquidi o gas infiammabili, o per applicazioni che richiedono l'utilizzo di utensili amagnetici e resistenti alla corrosione.



Gli utensili antiscintilla Beta sono certificati dall'Istituto per la ricerca e il collaudo BAM, secondo la Direttiva Europea 99/92/EC.



ATTENZIONE: rischio di esplosione in presenza di **ACETILENE**

Le caratteristiche meccaniche degli utensili Antiscintilla **Beta** sono diverse da quelle degli utensili normali in acciaio, devono essere usati con estrema cautela, evitando sovraccarichi.

CLASSIFICAZIONE DELLE ZONE A RISCHIO DI ESPLOSIONE

ATEX	CLASSIFICAZIONE DELLE ZONE A RISCHIO DI ESPLOSIONE	
	MEDIO BASSA	MOLTO BASSA
GAS	ZONA 1 Area in cui durante le normali attività è probabile la formazione di un'atmosfera esplosiva consistente in una miscela di aria e di sostanze infiammabili sotto forma di gas, vapore o nebbia.	ZONA 2 Area in cui durante le normali attività non è probabile la formazione di un'atmosfera esplosiva consistente in una miscela di aria e di sostanze infiammabili sotto forma di gas, vapore o nebbia e, qualora si verifichi, sia unicamente di breve durata.
	ZONA 21 Area in cui occasionalmente durante le normali attività è probabile la formazione di un'atmosfera esplosiva sotto forma di nube di polvere combustibile nell'aria.	ZONA 22 Area in cui durante le normali attività non è probabile la formazione di un'atmosfera esplosiva sotto forma di nube di polvere combustibile nell'aria e, qualora si verifichi, sia unicamente di breve durata.

30BA punzoni antiscintilla



Ø mm	L mm	S mm	€	1	000300806
5	150	15	66,00	1	000300806
8	150	17	81,50	1	000300808
10	150	19	101,00	1	000300810

31BA cacciaspina antiscintilla



Ø mm	L mm	€	1	000310853
3	110	28,50	1	000310853
4	110	62,00	1	000310854
6	115	94,50	1	000310856
8	120	107,00	1	000310858

31BA/C punzoni antiscintilla conici



Ø mm	Ø1 mm	L mm	€	1	000310876
*6	12	150	38,50	1	000310876
*7	13	150	45,50	1	000310877
*12	18	175	97,00	1	000310882
*13	29	255	304,00	1	000310883

32BA bulino antiscintilla



Ø mm	L mm	€	1	000320811
14	150	91,00	1	000320811

34BA scalpelli piatti antiscintilla

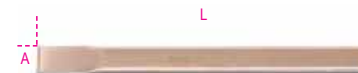

L mm	A mm	€	1	000340801
200	22	123,50	1	000340801
250	24	206,50	1	000340803
300	25	278,00	1	000340802

39BA

cunei antiscintilla



L mm	A mm	€		
150	40	54,00	1	000390801
230	40	181,50	1	000390802
250	40	284,00	1	000390803

42BA

chiavi combinate antiscintilla



mm	L mm	€		
6x6	105	57,50	1	000420806
7x7	105	65,00	1	000420807
8x8	120	72,50	1	000420808
9x9	120	83,00	1	000420809
10x10	135	89,50	1	000420810
11x11	135	94,50	1	000420811
12x12	150	103,50	1	000420812
13x13	150	107,00	1	000420813
14x14	175	112,00	1	000420814
15x15	175	118,00	1	000420815
16x16	195	122,50	1	000420816
17x17	200	128,50	1	000420817
18x18	215	144,00	1	000420818
19x19	220	147,00	1	000420819
20x20	230	153,00	1	000420820
21x21	240	162,50	1	000420821
22x22	250	173,00	1	000420822
24x24	268	201,00	1	000420824
26x26	290	242,50	1	000420826
27x27	290	270,00	1	000420827
28x28	290	317,00	1	000420828
30x30	313	324,00	1	000420830
32x32	333	356,00	1	000420832
34x34	360	388,00	1	000420834
35x35	360	440,00	1	000420835
36x36	355	459,00	1	000420836
38x38	430	484,00	1	000420838
41x41	430	569,00	1	000420841
46x46	480	666,00	1	000420846
50x50	520	705,00	1	000420850
55x55	560	776,00	1	000420855
60x60	580	828,00	1	000420860
*65x65	595	944,00	1	000420865
*70x70	630	1.060,00	1	000420870

42BA-AS

chiavi combinate antiscintilla



mm	L mm	€		
9/32x9/32	120	62,00	1	000420946
5/16x5/16	120	62,00	1	000420947
11/32x11/32	135	79,00	1	000420948
3/8x3/8	128	83,00	1	000420950
7/16x7/16	135	94,50	1	000420951

mm	L mm	€		
15/32x15/32	140	104,00	1	000420949
1/2x1/2	140	108,00	1	000420953
9/16x9/16	163	117,00	1	000420954
*19/32x19/32	195	140,50	1	000420955
5/8x5/8	177	141,50	1	000420956
11/16x11/16	195	151,00	1	000420957
3/4x3/4	215	155,50	1	000420959
13/16x13/16	230	181,50	1	000420961
7/8x7/8	235	188,00	1	000420962
15/16x15/16	256	209,00	1	000420964
*31/32x31/32	265	230,00	1	000420963
1x1	266	226,50	1	000420965
1.1/16x1.1/16	283	255,00	1	000420967
1.1/8x1.1/8	297	336,00	1	000420969
1.3/16x1.3/16	308	363,00	1	000420970
1.1/4x1.1/4	324	427,00	1	000420973
*1.7/16x1.7/16	360	518,00	1	000420976

55BA

chiavi a forchetta doppie antiscintilla



mm	L mm	€		
6x7	90	39,50	1	000550801
8x9	100	42,50	1	000550802
8x10	100	44,00	1	000550795
9x11	110	47,00	1	000550797
10x11	120	50,00	1	000550803
12x13	130	63,00	1	000550804
*12x14	130	76,50	1	000550846
13x14	133	76,00	1	000550799
14x15	145	76,50	1	000550805
14x17	150	81,50	1	000550806
16x17	165	82,50	1	000550807
17x19	170	108,00	1	000550847
18x19	170	110,50	1	000550809
*19x22	185	126,00	1	000550810
20x22	185	127,00	1	000550811
21x23	210	138,50	1	000550813
22x24	210	165,00	1	000550815
24x26	230	193,50	1	000550817
24x27	230	206,50	1	000550818
25x28	230	224,00	1	000550819
27x29	246	262,00	1	000550820
30x32	265	306,00	1	000550822
36x38	320	388,00	1	000550826
36x41	335	427,00	1	000550828
41x46	355	531,00	1	000550829
*46x50	370	608,00	1	000550830
*50x55	385	647,00	1	000550831
*55x60	415	803,00	1	000550832

55BA-AS

chiavi a forchetta doppie antiscintilla



mm	L mm	€		
3/8x7/16	110	52,00	1	000550853
1/2x9/16	130	62,00	1	000550854
5/8x11/16	160	91,00	1	000550857
3/4x13/16	180	112,00	1	000550859
7/8x15/16	210	158,00	1	000550865
1x1.1/16	230	213,50	1	000550868
1.1/8x1.3/16	245	278,00	1	000550870
1.1/4x1.5/16	255	329,00	1	000550872

58BA

chiavi a forchetta semplici a percussione, antiscintilla



mm	L mm	€		
17	125	106,00	1	000580817
19	125	110,00	1	000580819
22	135	110,50	1	000580822
24	150	124,50	1	000580824
27	165	152,50	1	000580827
30	180	191,50	1	000580830
32	190	224,00	1	000580832
*34	200	256,00	1	000580834
36	210	265,00	1	000580836
38	220	292,00	1	000580838
41	230	329,00	1	000580841
46	240	394,00	1	000580846
50	255	447,00	1	000580850
*55	305	557,00	1	000580855
*60	315	647,00	1	000580860
*65	335	751,00	1	000580865
*70	370	906,00	1	000580870
*75	375	1.049,00	1	000580875
*80	400	1.255,00	1	000580880
*85	400	1.475,00	1	000580885
*90	445	1.755,00	1	000580890
*95	445	2.030,00	1	000580895
*100	485	2.350,00	1	000580900
*110	513	2.910,00	1	000580901

58BA-AS

chiavi a forchetta semplici a percussione, antiscintilla



mm	L mm	A mm	S mm	€		
*11/16	125	40,5	11,0	117,00	1	000580904
*3/4	125	40,5	11,0	119,00	1	000580905
*7/8	135	46,2	12,0	122,00	1	000580906
*15/16	150	50,3	12,0	139,50	1	000580907
*31/32	150	50,3	12,0	156,50	1	000580954
*1	175	56,9	15,0	162,00	1	000580908
*1.1/8	190	64,0	15,5	208,00	1	000580909
*1.1/4	190	64,0	15,5	244,50	1	000580910
*1.7/16	210	75,0	18,5	284,00	1	000580912
*1.1/2	220	82,0	18,5	337,00	1	000580913
*1.5/8	230	86,8	18,5	363,00	1	000580914
*1.3/4	250	98,0	20,	459,00	1	000580970

78BA

chiavi poligonali a percussione, antiscintilla



mm	L mm	€		
17	145	110,50	1	000780817
19	145	121,50	1	000780819
22	165	123,50	1	000780822
24	140	151,00	1	000780824
27	155	173,00	1	000780827
30	165	201,00	1	000780830
32	180	217,50	1	000780832
34	192	239,50	1	000780834
36	208	265,00	1	000780836
38	215	311,00	1	000780838
41	225	369,00	1	000780841
46	245	413,00	1	000780846
50	250	479,00	1	000780850

mm	L mm	€		
55	265	557,00	1	000780855
60	275	602,00	1	000780860
65	295	647,00	1	000780865
70	310	732,00	1	000780870
75	325	822,00	1	000780875
80	340	880,00	1	000780880
*85	355	1.119,00	1	000780885
*90	380	1.315,00	1	000780890
*95	390	1.525,00	1	000780895
*100	410	1.740,00	1	000780900
*105	420	1.925,00	1	000780903
*110	445	2.200,00	1	000780901
*120	480	2.600,00	1	000780902

78BA-AS

chiavi poligonali a percussione, antiscintilla



"	L mm	€		
11/16	145	109,50	1	000780908
3/4	145	113,50	1	000780909
7/8	155	127,00	1	000780935
15/16	165	140,50	1	000780936
*31/32	165	164,00	1	000780937
1	175	164,00	1	000780938
*1.1/16	175	194,50	1	000780939
1.1/8	180	196,50	1	000780940
1.3/16	185	204,50	1	000780941
1.1/4	177	222,50	1	000780910
*1.5/16	200	226,50	1	000780954
*1.3/8	205	237,00	1	000780911
1.7/16	208	295,00	1	000780912
*1.1/2	215	308,00	1	000780913
*1.9/16	225	382,00	1	000780947
*1.11/16	225	403,00	1	000780962
1.5/8	225	374,00	1	000780914
*1.3/4	235	413,00	1	000780963
1.13/16	243	427,00	1	000780916
1.7/8	235	484,00	1	000780915
2	254	503,00	1	000780918
2.3/16	264	588,00	1	000780920
2.3/8	275	641,00	1	000780922
*2.9/16	286	666,00	1	000780924
*2.15/16	311	808,00	1	000780926
*3.1/8	325	938,00	1	000780928
*3.1/2	355	1.184,00	1	000780930

89BA

chiavi poligonali semplici, antiscintilla



mm	L mm	€		
10	200	125,50	1	000890810
11	210	130,00	1	000890811
12	220	135,00	1	000890812
13	230	138,50	1	000890813
14	240	140,50	1	000890814
16	260	151,00	1	000890816
17	270	156,50	1	000890817
18	280	168,50	1	000890818
19	300	174,00	1	000890819
20	310	217,50	1	000890820
22	330	217,50	1	000890822
24	350	238,50	1	000890824
27	370	294,00	1	000890827
30	400	329,00	1	000890830
32	420	346,00	1	000890832

90BA

chiavi poligonali doppie antiscintilla



mm	L mm	€		
6x7	122	40,00	1	000900801
8x9	128	52,00	1	000900802
10x11	155	58,50	1	000900803
12x13	175	68,50	1	000900806
12x14	180	73,50	1	000900807
14x15	200	82,50	1	000900808
14x17	220	84,00	1	000900809
16x17	230	99,00	1	000900811
16x18	235	99,00	1	000900812
17x19	250	102,00	1	000900814
18x19	265	112,00	1	000900815
19x22	280	118,00	1	000900817
20x22	295	134,00	1	000900818
21x23	298	141,50	1	000900820
22x24	315	171,00	1	000900821
24x26	333	220,00	1	000900822
24x27	340	220,00	1	000900823
30x32	395	324,00	1	000900824
34x36	410	459,00	1	000900826
*36x41	450	621,00	1	000900828
*41x46	470	763,00	1	000900829
*46x50	490	847,00	1	000900830

91BA

chiavi poligonali curve antiscintilla



mm	Ø mm	€		
24	38	265,00	1	000910824
27	42	317,00	1	000910827
30	48	363,00	1	000910830
32	49	405,00	1	000910832
36	54	440,00	1	000910836
41	62	493,00	1	000910841
*46	69	654,00	1	000910846
*50	75	699,00	1	000910850
*55	82	808,00	1	000910855

92BA

leve di manovra per art. 91BA, antiscintilla



	L mm	91BA mm	Ø mm	€		
92BA/1	460	24÷30	25	314,00	1	000920810
92BA/2	610	32÷41	28	405,00	1	000920820
*92BA/3	760	46÷55	32	544,00	1	000920830

93BA

chiave a cricchetto per ponteggi antiscintilla



mm	L mm	€		
21x22	345	654,00	1	000930821

95BA

chiavi poligonali doppie diritte, antiscintilla



mm	L mm	€		
7x9	115	39,50	1	000950801
8x10	115	44,00	1	000950802
10x11	140	48,50	1	000950804
10x12	140	57,50	1	000950805
12x14	145	66,00	1	000950806
14x17	165	79,00	1	000950807
*16x18	170	102,50	1	000950809
*17x19	185	89,50	1	000950808
*18x19	185	112,00	1	000950810
*19x22	200	139,50	1	000950812
*21x23	230	154,00	1	000950815
*24x27	255	196,50	1	000950817
*30x32	295	295,00	1	000950820

96BA

chiavi maschio esagonale piegate antiscintilla

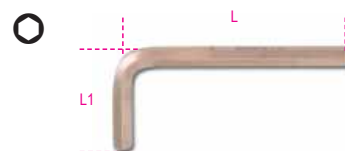

mm	L mm	L1 mm	€		
1,5	50	17	81,50	1	000960760
2	50	16	83,00	1	000960762
2,5	56	20	89,00	1	000960761
3	63	21	90,50	1	000960763
4	69	25	95,50	1	000960764
5	78	29	99,00	1	000960765
6	88	33	101,00	1	000960766
7	93	34	106,00	1	000960767
8	97	36	112,00	1	000960768
9	104	37	117,50	1	000960769
10	110	39	121,50	1	000960770
11	118	42	129,00	1	000960771
12	122	44	147,50	1	000960772
14	150	58	165,00	1	000960774
15	156	60	174,00	1	000960775
16	162	63	191,50	1	000960776
17	168	65	201,00	1	000960777
19	177	72	225,00	1	000960779
22	186	77	263,00	1	000960802
24	192	82	304,00	1	000960804

96BA/BP

chiavi maschio esagonale piegate con estremità sferica, antiscintilla



mm	L mm	L1 mm	€		
1,5	50	16	83,50	1	000961800
2	50	16	84,00	1	000961801
2,5	63	20	95,00	1	000961802
3	60	20	95,50	1	000961803
3,5	70	25	99,50	1	000961799
4	66	25	100,00	1	000961804
5	75	28	102,00	1	000961805
6	84	32	105,00	1	000961806
8	92	36	114,50	1	000961808
10	102	40	123,50	1	000961810
12	113	45	152,50	1	000961812

96BAF-AS

chiavi maschio esagonali piegate, antiscintilla



mm	L mm	L1 mm	€		
*1/16	59	25	66,00	1	000962831
*5/64	59	25	68,00	1	000962832
*3/32	59	25	71,00	1	000962833
*7/64	59	25	74,00	1	000962834
*1/8	59	25	77,00	1	000962835
*9/64	64	29	83,00	1	000962836
*5/32	65	30	85,50	1	000962837
*3/16	79	31	90,50	1	000962838
*7/32	85	37	94,50	1	000962839
*1/4	85	37	99,00	1	000962840
9/32	88	38	102,00	1	000962841
*5/16	92	44	106,50	1	000962842
11/32	100	44	109,50	1	000962843
*3/8	110	45	116,00	1	000962844
*7/16	119	48	123,50	1	000962845
*1/2	140	55	151,00	1	000962846
*9/16	150	58	173,00	1	000962847

99BA

chiavi a settore articolate con nasello quadro antiscintilla per ghiere



mm	A mm	€		
32-75	4,0	214,50	1	000990803
50-120	4,5	337,00	1	000990805
115-170	4,5	544,00	1	000990811

110BA

chiavi regolabili a rullino, antiscintilla



L mm	A max	€		
100	13	159,00	1	001100810
150	18	182,50	1	001100815
200	24	214,50	1	001100820
250	30	259,00	1	001100825
300	36	364,00	1	001100830
375	46	490,00	1	001100837
*450	55	686,00	1	001100845
*600	65	1.145,00	1	001100860

330BA

tagliatubi per tubi gas, antiscintilla



330BA/2	Ø max 50 mm	L mm 375	€		
	2"		835,00	1	003300802

330BA/2R

coltello e spina di ricambio per 330BA per tubi gas, antiscintilla



330BA /2-R	€		
	84,00	1	003300822

363BA

giratubi modello americano, antiscintilla



L mm	Ø max	Ø max mm	€		
150	1/2" gas	20	271,00	1	003630815
200	1" gas	30	272,00	1	003630820
250	1 1/2" gas	49	317,00	1	003630825
300	2" gas	60	403,00	1	003630830
350	2" gas	60	498,00	1	003630835
450	2 1/2" gas	76	756,00	1	003630845
600	3" gas	90	1.054,00	1	003630860

378BA

giratubi modello svedese, antiscintilla



L mm	Ø max "	€		
430	1" 1/2 gas	824,00	1	003780800
530	2" gas	1.016,00	1	003780801

386BA

giratubi reversibili a catena modello pesante antiscintilla

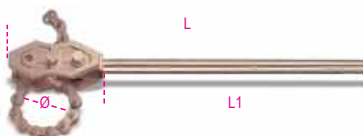

L mm	Ø max mm	L1 mm	€		
600	100	470	1.245,00	1	003860806
900	200	750	2.065,00	1	003860809

911BA

chiavi a bussola poligonali, antiscintilla

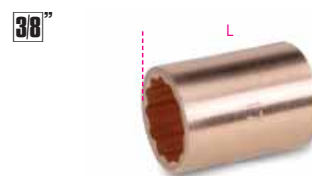

mm	L mm	€		
6	28	55,00	1	009110806
7	28	58,50	1	009110807
8	28	63,00	1	009110808
9	28	67,00	1	009110809
10	32	91,00	1	009110810
11	32	96,00	1	009110811
12	32	101,50	1	009110812
13	32	106,00	1	009110813
14	32	112,50	1	009110814
15	32	113,50	1	009110815
16	32	119,00	1	009110816
17	32	123,50	1	009110817
18	32	125,50	1	009110818
19	32	130,00	1	009110819

911BA/16

raccordo con attacco quadro femmina 3/8" e maschio 1/2" antiscintilla

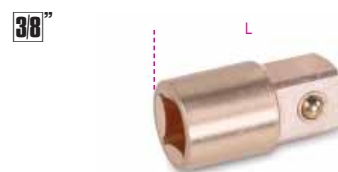

L mm	3/8"	1/2"	€		
34			116,00	1	009110836

911BA/20

prolunga con attacco quadro maschio e femmina 3/8", antiscintilla



L mm	€		
75	93,50	1	009110840

911BA/55

cricchetto semplice con quadro scorrevole 3/8", antiscintilla

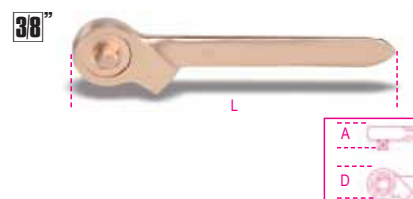

L mm	D mm	A mm	€		
200	45	16,5	199,00	1	009110882



921BA

chiavi a bussola poligonali,
antiscintilla

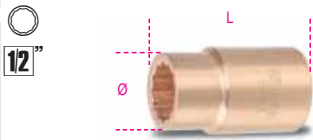

mm	Ø mm	L mm	€	1	009210808
8	15,0	40	82,50	1	009210808
9	16,0	40	87,00	1	009210809
10	17,5	40	99,50	1	009210810
11	18,0	40	102,50	1	009210811
12	18,5	40	109,50	1	009210812
13	20,0	40	116,00	1	009210813
14	21,0	40	118,00	1	009210814
15	21,5	40	122,50	1	009210815
16	24,0	40	126,50	1	009210816
17	25,0	40	131,00	1	009210817
18	25,0	40	136,50	1	009210818
19	28,0	42	140,50	1	009210819
20	29,0	42	147,50	1	009210820
21	30,0	43	150,00	1	009210821
22	30,5	43	156,50	1	009210822
24	34,0	43	183,50	1	009210824
25	36,0	43	199,00	1	009210825
26	37,5	43	212,50	1	009210826
27	37,5	45	222,50	1	009210827
28	38,9	46	232,50	1	009210828
30	41,5	46	262,00	1	009210830
32	43,5	46	289,00	1	009210832

921BA-AS

chiavi a bussola poligonali,
antiscintilla

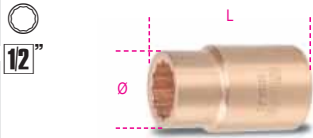

mm	Ø mm	L mm	€	1	009210958
5/16	24,0	40	88,00	1	009210958
3/8	24,0	40	95,00	1	009210960
7/16	24,0	40	103,50	1	009210961
1/2	24,0	40	110,50	1	009210963
9/16	24,0	40	116,00	1	009210964
5/8	25,0	40	131,00	1	009210966
11/16	25,5	40	141,50	1	009210967
3/4	28,0	42	156,50	1	009210969
13/16	30,0	43	165,00	1	009210971
7/8	31,5	43	180,50	1	009210972
15/16	34,0	43	190,50	1	009210974
1	36,0	43	212,50	1	009210975
1.1/16	38,0	46	228,50	1	009210977
1.1/4	42,0	46	304,00	1	009210982
1.7/16	50,5	50	374,00	1	009210986

921BA/15

raccordo con attacco quadro
femmina 1/2" e maschio 3/8"
antiscintilla

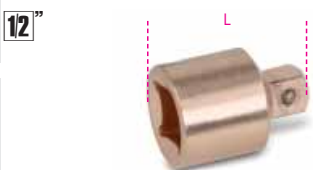

L mm	1/2"	3/8"	€	1	009210839
34	1/2"	3/8"	104,50	1	009210839

921BA/16

raccordo con attacco quadro
femmina 1/2" e maschio 3/4"
antiscintilla

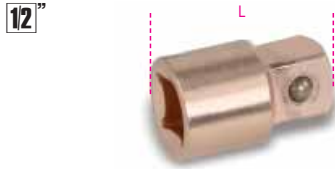

L mm	1/2"	3/4"	€	1	009210840
34	1/2"	3/4"	137,50	1	009210840

921BA/21 - 921BA/22

prolunghe con attacchi quadri
maschio e femmina 1/2",
antiscintilla



	L mm	Ø mm	€	1	009210842
921BA/21	125	30	139,50	1	009210842
921BA/22	250	31	194,50	1	009210844

921BA/25

snodo con attacchi quadri
maschio e femmina 1/2",
antiscintilla



L mm	Ø mm	1/2"	1/2"	€	1	009210845
80	25	1/2"	1/2"	141,50	1	009210845

921BA/42

quadro maschio 1/2" con spina scorrevole,
antiscintilla

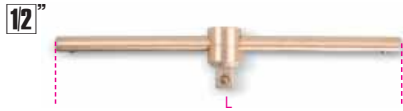

L mm	€	1	009210846
250	230,00	1	009210846

921BA/50

cricchetto semplice
con quadro scorrevole 1/2",
antiscintilla



L mm	D mm	A mm	€	1	009210850
250	45	16,5	265,00	1	009210850

921BA/R50

set di ricambio
antiscintilla



L mm	€	1	009210851
1/2"	79,00	1	009210851

926BA

chiavi a bussola poligonali,
antiscintilla

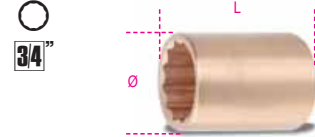

mm	Ø mm	L mm	€	1	009260822
22	40	55	173,00	1	009260822
24	40	55	193,50	1	009260824
26	40	55	220,00	1	009260826
27	40	55	232,50	1	009260827
28	41	55	272,00	1	009260828
30	43	60	278,00	1	009260830
32	45	60	311,00	1	009260832
34	48	60	330,00	1	009260834
36	50	60	358,00	1	009260836
38	53	60	382,00	1	009260838
41	57	65	419,00	1	009260841
46	63	65	498,00	1	009260846
50	68	70	546,00	1	009260850

926BA/15

raccordo con attacco quadro
femmina 3/4" e maschio 1/2"
antiscintilla



L mm	3/4"	1/2"	€	1	009260861
55	3/4"	1/2"	137,50	1	009260861

926BA/22

prolunghe con attacchi quadri
maschio e femmina 3/4", antiscintilla



L mm	Ø mm	€	1	009260872	
926BA/22	200	38	278,00	1	009260872

926BA/42

quadro maschio 3/4" con spina scorrevole,
antiscintilla

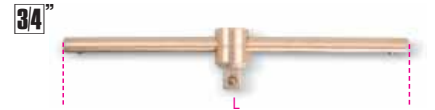

L mm	€	1	009260876
400	403,00	1	009260876

926BA/50

cricchetto semplice con quadro scorrevole 3/4", antiscintilla



L mm	D mm	A mm	€		
300	61	22	413,00	1	009260880

926BA/R50

set di ricambio antiscintilla



3/4"	€		
	131,00	1	009260881

937BA

chiavi a pipa esagonali, antiscintilla



Ø mm	L mm	A mm	€		
13	240	45	102,50	1	009370813
17	260	51	148,50	1	009370817
19	270	55	155,50	1	009370819
22	278	59	203,50	1	009370822
24	286	63	217,50	1	009370824
27	294	69	231,00	1	009370827
30	302	75	255,00	1	009370830
32	310	81	278,00	1	009370832
*36	330	85	327,00	1	009370836
*41	350	90	395,00	1	009370841

951BA

chiavi a T maschio esagonale, antiscintilla



mm	L mm	L1 mm	€		
4	100	90	173,00	1	009510904
5	100	90	181,50	1	009510905
6	100	90	191,50	1	009510906

961BA

leve scrostatore, antiscintilla



L mm	A mm	€		
250	39	152,50	1	009610802
350	55	230,00	1	009610806

963BA

leve con estremità a punta e piatta curva, antiscintilla



L mm	A mm	€		
500	24	426,00	1	009630801
*800	24	668,00	1	009630803
*1000	30	1.415,00	1	009630805

964BA

aprifusti antiscintilla



L mm	€		
385	403,00	1	009640801

964BA/L

cesoia universale per fusti, antiscintilla

Per l'apertura dei fusti metallici con bordo



*964BA/L	L mm	€		
	510	2.035,00	1	009640821

965BA

chiavi di manovra semplici antiscintilla, per valvole di sicurezza



A mm	A1 mm	L mm	€		
30	44	200	176,50	1	009650830
32	50	300	246,50	1	009650832
35	47	250	201,00	1	009650835
40	50	300	231,00	1	009650840
45	58	350	298,00	1	009650845
48	62	375	311,00	1	009650848
50	67	400	341,00	1	009650850

A mm	A1 mm	L mm	€		
55	73	450	408,00	1	009650855
60	79	500	440,00	1	009650860
*65	82	550	493,00	1	009650865
*70	85	600	544,00	1	009650870

966BA

chiave di manovra antiscintilla, per valvole di sicurezza

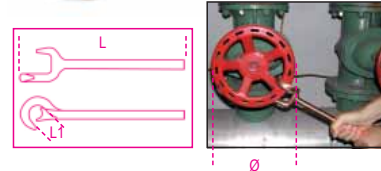

L mm	L1 mm	Ø min+max mm	€		
350	40	50÷150	386,00	1	009660801

966BA/V

chiavi di manovra antiscintilla, per valvole di sicurezza

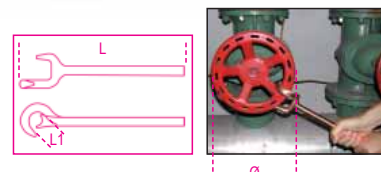

L mm	L1 mm	Ø min+max mm	€		
370	36	125÷250	386,00	1	009660812
430	48	250÷400	557,00	1	009660814

1032BA

pinze a becchi diritti antiscintilla per anelli elastici di sicurezza, per fori manici ricoperti in PVC



L mm	Ø mm	€		
200	40÷100	252,00	1	010320820

1036BA

pinze a becchi diritti antiscintilla per anelli elastici di sicurezza, per alberi manici ricoperti in PVC



L mm	Ø mm	€		
200	40÷100	252,00	1	010360820

1046BA

pinze regolabili
cerniera a cremagliera,
antiscintilla



L mm	A max mm	€	🔧	📦
250	32	329,00	1	010460801
*300	52	434,00	1	010460803

1052BA

pinze regolabili autobloccanti
ganasce concave, antiscintilla

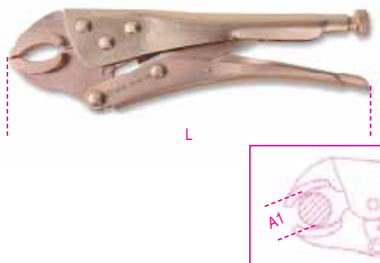

L mm	A1 max mm	€	🔧	📦
225	40,0	324,00	1	010520824

1082BA

tronchese a taglianti diagonali,
antiscintilla

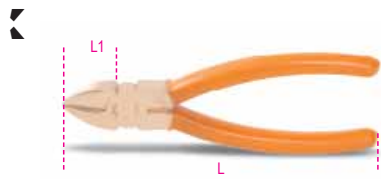

L mm	L1 mm	€	🔧	📦
160	22	235,50	1	010820801

1100BA

troncabulloni,
antiscintilla



L mm	€	🔧	📦
600	1.685,00	1	011000860

1137BA

pinza da fochino,
antiscintilla



L mm	L1 mm	€	🔧	📦
185	30	438,00	1	011370801

1137BA/RC

lama di ricambio per 1137BA



1137BA/RC	€	🔧	📦
	84,00	1	011370851

1150BA

pinza universale,
antiscintilla

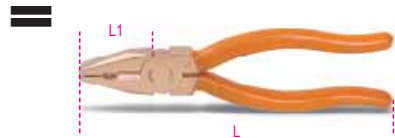

L mm	L1 mm	€	🔧	📦
200	40	277,00	1	011500820

1162BA

pinza a becchi piatti lunghissimi
diritti zigrinati,
antiscintilla



L mm	L1 mm	€	🔧	📦
150	54	217,50	1	011620815

1166BA

pinza a becchi mezzotondi
lunghissimi
diritti zigrinati,
antiscintilla



L mm	L1 mm	€	🔧	📦
150	54	217,50	1	011660815

1270BA

giravite per viti a testa con intaglio,
antiscintilla



AxL mm	L1 mm	€	🔧	📦
3x75	178	39,50	1	012700803
4x100	209	48,50	1	012700804
5x150	250	65,00	1	012700805
6x150	270	68,50	1	012700806
10x250	382	104,50	1	012700810
8x200	312	78,00	1	012700808

1272BA

giravite per viti
con impronta a croce Phillips®,
antiscintilla



PHxDxL mm	L1 mm	€	🔧	📦
1x5x100	209	54,50	1	012720801
2x6x150	270	69,50	1	012720802
3x8x200	332	83,50	1	012720803

1277BA

giravite per viti con impronta Torx®,
antiscintilla



Ø	L mm	L1 mm	Ø mm	€	🔧	📦
T10	75	184	5	52,00	1	012770810
T15	75	184	5	56,00	1	012770815
T20	100	209	6	76,00	1	012770820
T25	125	209	6	80,00	1	012770825
T30	150	270	6	88,00	1	012770830
T40	200	332	8	117,00	1	012770840

1370BA

martelli tipo tedesco antiscintilla,
manico in legno



g	A mm	L mm	L1 mm	€	🔧	📦
500	30	310	108	145,50	1	013700805
1000	35	340	137	256,00	1	013700810

1370BA/MR

manici di ricambio per 1370BA

	€		
1370BA/MR 500 1370BA/500	24,50	1	013700865
1370BA/MR 1000 1370BA/1000	30,00	1	013700870

1370BA/PL

martelli tipo tedesco antiscintilla,
manico in fibra



g	A mm	L mm	L1 mm	€		
500	30	310	108	145,50	1	013700815
1000	35	340	137	256,00	1	013700820

1375BA/PL

martello con penna sferica
a granchio antiscintilla,
manico in fibra



g	L mm	L1 mm	Ø mm	€		
680	321	125	30	187,00	1	013750800

1377BA

martello con testa tonda e penna sferica
per calderai e lattonieri,
antiscintilla



g	L1 mm	L mm	€		
340	90	280	93,50	1	013770834

1377BA/PL

martello con testa tonda e penna sferica
per calderai e lattonieri, manico in fibra,
antiscintilla



g	L1 mm	L mm	€		
340	90	280	93,50	1	013770884

1379BA

martello scrostatore antiscintilla,
manico in legno

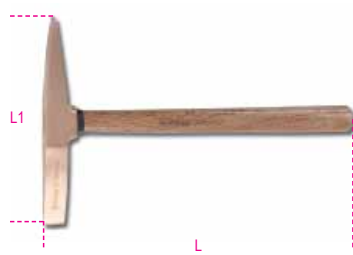

g	L1 mm	L mm	€		
500	142	315	181,50	1	013790850

1380BA

mazzette antiscintilla,
manico in legno



g	L1 mm	L mm	€		
1000	100	400	314,00	1	013800810
1500	118	400	382,00	1	013800815
2000	126	400	503,00	1	013800820

1380BA/MR

manici di ricambio per 1380BA

	€		
1380BA/MR 1000 1380BA/1000	32,00	1	013800860
1380BA/MR 1500 1380BA/1500	32,00	1	013800865
1380BA/MR 2000 1380BA/2000	32,00	1	013800870

1380BA/PL

mazzette antiscintilla,
manico in fibra



g	L1 mm	L mm	€		
500	80	310	156,50	1	013800955
1000	94	350	292,00	1	013800960
1500	115	400	419,00	1	013800965
2000	125,5	400	549,00	1	013800970

1381BA

mazze antiscintilla,
manico in legno



g	L1 mm	L mm	€		
5000	179	900	1.172,00	1	013810850
★8000	190	900	1.875,00	1	013810858

1381BA/MR

manico di ricambio per 1381BA

	€		
1381BA/MR 5000 1381BA/5000	48,50	1	013810870
★1381BA/MR 8000 1381BA/8000	56,50	1	013810878

1381BA/PL

mazze antiscintilla,
manico in fibra



g	L1 mm	L mm	€		
5000	172	900	1.074,00	1	013810885
8000	204	900	1.925,00	1	013810888

1390BA

mazuola con battenti in nylon,
antiscintilla



Ø mm	L mm	L1 mm	€		
★52	370	130	252,00	1	013900805

1390BA/R

battenti di ricambio in Nylon per 1390BA



D mm	€		
52	51,00	4	013900885



1602BA

pinza per capicorda preisolati
modello leggero,
antiscintilla

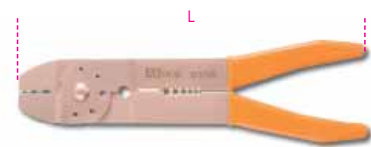

mm ²	L mm	€	Icon	Code
0.75+6	200	310,00	1	016020801

1701BA

scalpelli esagonale,
antiscintilla



L mm	A mm	S mm	€	Icon	Code
150	12	10	57,00	1	017010810
200	16	14	91,00	1	017010814
250	18	14	112,00	1	017010815
350	19	17	295,00	1	017010817

1703BA/A

ascia antiscintilla



L mm	L1 mm	A mm	€	Icon	Code
340	145	82	256,00	1	017030082

1703BA/P

piccone antiscintilla



A mm	L mm	L1 mm	€	Icon	Code
56	1050	410	669,00	1	017030150

1703BA/PL

badile antiscintilla



A mm	L1 mm	L mm	€	Icon	Code
240	420	990	564,00	1	017030200

1717BA

spatole rigide,
antiscintilla



A mm	€	Icon	Code
60	137,50	1	017170801
80	152,50	1	017170803

1717BA/1

raschiapreti antiscintilla



A mm	L mm	€	Icon	Code
100	220	275,00	1	017170805

1719BA8

lime da 8" antiscintilla



	L mm	€	Icon	Code
1719BA8/P	200	168,50	1	017190801
1719BA8/M	200	174,00	1	017190805
1719BA8/R	200	178,00	1	017190810
1719BA8/T	200	164,00	1	017190815
1719BA8/Q	200	164,00	1	017190820

1719BA12

lima da 12" antiscintilla



	L mm	€	Icon	Code
1719BA12/P	300	304,00	1	017190831

1727BA

seghetto e lama,
antiscintilla



L mm	L1 mm	€	Icon	Code
500	300	537,00	1	017270801

1728BA

lama per seghetti,
antiscintilla



L mm	€	Icon	Code
300	104,00	1	017280801

1737BA

spazzola con fili antiscintilla



L mm	A mm	€	Icon	Code
294	29	69,50	1	017370801

1758BA

imbuto antiscintilla



Ø mm	H mm	€	Icon	Code
160	150	97,00	1	017580815

1776BA

coltello antiscintilla



L1 mm	L mm	€	Icon	Code
145	250	151,00	1	017760801

1784BA

forbici antiscintilla



L mm	€	Icon	Code
225	262,00	1	017840822





ELETTROUTENSILI

Strumenti di lavoro affidabili e duraturi nel tempo, in grado di soddisfare le esigenze lavorative di ogni professionista.

La famiglia di Elettrotensili Beta si compone di:

UTENSILI A BATTERIA

UTENSILI A FILO



Beta
POWERTOOLS

UTENSILI A BATTERIA

Beta
3-YEAR
WARRANTY



La nuova gamma di utensili a batteria include macchine performanti nelle classi di voltaggio 12V e 20V.

Nella **linea 12V** rientrano il trapano avvitatore e l'avvitatore portainseri, indispensabili per facilitare il lavoro quotidiano grazie alle loro prestazioni, leggerezza e compattezza.

Della **linea 20V** fanno parte invece gli utensili a batteria utilizzati per prestazioni che richiedono **elevate performances, qualità costruttiva, affidabilità e durata nel tempo.**

Sono proprio queste le basi sulle quali Beta ha sviluppato la sua nuova gamma, all'interno della quale è presente una proposta completa di utensili a batteria, dal trapano avvitatore con elevata coppia torcente agli avvitatori ad impulsi con attacco quadro da 1/2".

Tutti i nuovi elettrotensili Beta 20V sono dotati di motori Brushless (senza spazzole) e meccanismi interni di elevata qualità, per un notevole incremento delle prestazioni e maggior durata dell'utensile stesso.

L'elettrotensile che più rappresenta la nuova linea è sicuramente l'avvitatore ad impulsi con coppia massima in svitamento di **1200Nm**, il partner di lavoro ideale per chi è alla ricerca di potenza e prestazioni d'utilizzo massime.

Le nostre batterie agli ioni di litio 20V sono fornibili fino alla capacità 6Ah e sono utilizzabili su tutti gli utensili appartenenti alla linea.



Inquadra il QR code per maggiori informazioni sull'estensione gratuita a 3 anni della garanzia

1972/K12V-10

kit trapano avvitatore ultracompatto 12V

CE

- **Ultracompatto**, solo 170 mm di lunghezza, **ultraleggero**, solo 1,1 kg con batteria e **perfettamente bilanciato**
- Doppia velocità meccanica con ingranaggi in acciaio e frizione a 20 posizioni
- Coppia fino a 30 Nm e 1300 giri/min (400 giri/min in 1° marcia); fora fino ad un diametro di 10 mm nell'acciaio e 20 mm nel legno
- Batterie da 2Ah e indicatore di carica sul corpo macchina
- Impugnatura ergonomica antiscivolo
- LED frontale
- Mandrino autoserrante da 10 mm
- Clip da cintura destra/sinistra
- Selettore avvita-svita-blocco (per il trasporto)
- **Fornito in valigetta rigida con 2 batterie agli ioni di litio da 2 Ah e caricatore rapido (50 min)**

Beta
**3-YEAR
WARRANTY**



1972/K12V-10

€ 263,00



1



019720112

316x254x96 mm - 1,1 kg

1982/K12V

kit avvitatore reversibile ad impulsi 12V

ideale per spazi ristretti, esercita una coppia elevata di 80Nm e si utilizza con una mano

CE

- **Ultracompatto**: solo 160 mm di lunghezza, **ultraleggero**: solo 1 kg con batteria e **perfettamente bilanciato**
- Attacco esagonale da 1/4" con ghiera di bloccaggio
- Clip da cintura destra/sinistra
- LED frontale
- Selettore avvita-svita-blocco (per il trasporto)
- Impugnatura ergonomica antiscivolo
- Scatola ingranaggi interamente metallica
- Batterie da 2Ah con indicatore di carica sul corpo macchina
- **Fornito in valigetta rigida con 2 batterie agli ioni di litio da 2 Ah e caricatore rapido (50 min)**

Beta
**3-YEAR
WARRANTY**



1982/K12V

€ 263,00



1



019820112

316x254x96 mm - 1,1 kg

1972/K12V-COMBO

kit 12V trapano avvitatore ultracompatto + avvitatore ad impulsi 1/4" HEX (12V)

Contenuto valigetta:

- Pz. 1 trapano avvitatore ultracompatto 12V, con mandrino autoserrante da 10mm
- Pz. 1 avvitatore reversibile ad impulsi 12V, con attacco esagonale da 1/4"
- Pz. 2 batterie agli ioni di litio da 2Ah
- Pz. 1 caricabatterie rapido

CE



Beta
**3-YEAR
WARRANTY**



+



1972/K12V-COMBO

€ 447,00



1



019720010

310x295x100 mm - 3 kg

1972/12V-10

trapano avvitatore ultracompatto 12V (corpo macchina)

- **Ultracompatto**, solo 170 mm di lunghezza, **ultraleggero**, solo 1,1 kg con batteria e **perfettamente bilanciato**
- Mandrino autoserrante in metallo da 10 mm
- Coppia massima 30 Nm fora fino ad un diametro di 10 mm nell'acciaio e 20 mm nel legno
- Doppia velocità meccanica con ingranaggi in acciaio (0-400/1300 giri/min)
- 20 posizioni di regolazione della coppia
- Selettore avvita-svita-blocco (per il trasporto)
- LED frontale
- Impugnatura ergonomica antiscivolo
- Clip da cintura destra/sinistra

📏 790 g

1972/12V-10

€ 109,00 1 019720113

Beta
3-YEAR
WARRANTY



CE

1982/12V

avvitatore reversibile ad impulsi 12V (corpo macchina)

Ideale per spazi ristretti, esercita una coppia elevata di 80Nm e si utilizza con una mano

- **Ultracompatto**: solo 160 mm di lunghezza, **ultraleggero**: solo 1 kg con batteria e **perfettamente bilanciato**
- attacco esagonale da 1/4" con ghiera di bloccaggio
- clip da cintura destra/sinistra
- LED frontale
- selettore avvita-svita-blocco (per il trasporto)
- impugnatura ergonomica antiscivolo
- scatola ingranaggi interamente metallica

📏 800 g

1982/12V

€ 116,00 1 019820113

Beta
3-YEAR
WARRANTY



CE

1994BL 12V-2AH

batteria agli ioni di litio da 2Ah per utensili 12V

Caratteristiche principali

- Tensione della batteria 12V
- Capacità della batteria 2Ah
- Capacità energetica 24Wh
- Tipo batteria Li-ion

📏 170 g

1994BL 12V-2AH

€ 49,00 1 019940015



CE

1994CB 12V

caricabatteria rapido 12V 110V-240V

Caratteristiche principali:

- Indicatore LED di stato di carica
- Tensione di ingresso nominale: 110V-240V ~ 50/60Hz
- Voltaggio in uscita: 12.6V
- Corrente di carica: 2A
- Potenza di ingresso nominale: 35W
- Tempo di ricarica batteria da 2Ah: 50 min

📏 260 g

1994CB 12V

€ 49,00 1 019940123



CE

1972/K20V-13BMC

kit trapano avvitatore a percussione 20V BRUSHLESS

CE

• Motore digitale BRUSHLESS (senza spazzole)

Notevole incremento delle prestazioni fra cui: maggiore potenza, minori consumi di energia, vita utile del motore estesa, miglior dosaggio della potenza dal pulsante

- 3 modalità di utilizzo: foratura, avvitatura e foratura con percussione
- Compatto: solo 210 mm di lunghezza
- Impugnatura ergonomica antiscivolo
- Selettore avvita-svita-blocco (per il trasporto)
- Scatola ingranaggi interamente metallica
- Luce LED integrata per operare anche in condizioni di scarsa visibilità
- Clip da cintura destra/sinistra
- Impugnatura laterale aggiuntiva per impiego a coppia elevata
- **Fornito in valigetta rigida con 2 batterie agli ioni di litio da 4 Ah e caricatore rapido**

Caratteristiche principali:

- Coppia massima 80 Nm
- 20 posizioni di regolazione della coppia
- Mandrino autoserrante in metallo da 13 mm
- Doppia velocità meccanica con ingranaggi in acciaio (0-450/1650 giri/min)
- Diametro max foratura legno 55 mm
- Diametro max foratura metallo 13 mm
- Diametro max foratura muratura 13 mm

Beta
**3-YEAR
WARRANTY**

DISPONIBILE
DA MAGGIO



1972/K20V-13BMC

€ 571,00 1 019720020

490x370x125 mm - 5,5 kg

1972/20V-13BMC

trapano avvitatore a percussione 20V BRUSHLESS (corpo macchina)

CE

• Motore digitale BRUSHLESS (senza spazzole)

Notevole incremento delle prestazioni fra cui: maggiore potenza, minori consumi di energia, vita utile del motore estesa, miglior dosaggio della potenza dal pulsante

- 3 modalità di utilizzo: foratura, avvitatura e foratura con percussione
- Compatto: solo 210 mm di lunghezza
- Impugnatura ergonomica antiscivolo
- Selettore avvita-svita-blocco (per il trasporto)
- Scatola ingranaggi interamente metallica
- Luce LED integrata per operare anche in condizioni di scarsa visibilità
- Clip da cintura destra/sinistra
- Impugnatura laterale aggiuntiva per impiego a coppia elevata
- **Fornito in valigetta rigida senza batterie e caricatore**

Caratteristiche principali:

- Coppia massima 80 Nm
- 20 posizioni di regolazione della coppia
- Mandrino autoserrante in metallo da 13 mm
- Doppia velocità meccanica con ingranaggi in acciaio (0-450/1650 giri/min)
- Diametro max foratura legno 55 mm
- Diametro max foratura metallo 13 mm
- Diametro max foratura muratura 13 mm

Beta
**3-YEAR
WARRANTY**

DISPONIBILE
DA MAGGIO



1972/20V-13BMC

€ 235,00 1 019720019

490x370x125 mm - 3,6 kg

1984/K600

kit avvitatore reversibile ad impulsi 20V BRUSHLESS con attacco 1/2" - 600Nm

- 3 diverse impostazioni di coppia e numero di giri in avvitamento
- Fino a 600Nm di coppia massima in svitamento

• Motore digitale BRUSHLESS (senza spazzole)

- Notevole incremento delle prestazioni fra cui: maggiore potenza, minori consumi di energia, vita utile del motore estesa, miglior dosaggio della potenza dal pulsante
- Attacco quadro maschio da 1/2" con anello trattieni-bussola
- Scatola ingranaggi interamente metallica
- Impugnatura ergonomica antiscivolo
- Selettore avvita-svita-blocco (per il trasporto)
- Luce LED integrata per operare anche in condizioni di scarsa visibilità
- Clip da cintura destra/sinistra

Serraggio

Possibilità di scelta fra 3 differenti impostazioni di coppia e numero di giri (bassa - media - alta):

- 1: 200 Nm; 100 rpm
- 2: 350 Nm; 1500 rpm
- 3: 550 Nm; 1800 rpm

Disserraggio

- 1: 600 Nm: l'avvitatore applica la coppia massima in continuo (svitamento libero)
- 2: 600 Nm - Autostop: l'avvitatore applica la coppia massima fino allo svitamento totale del dado per poi arrestarsi automaticamente (svitamento a singolo impulsi)

Fornito in pratica valigetta rigida con 2 batterie agli ioni di litio (4 Ah) e caricatore rapido.



1984/K600

€ 658,00 1 019840060

490x370x125 mm - 6,3 kg

1984 20V/600BMC

avvitatore reversibile ad impulsi 20V BRUSHLESS con attacco 1/2" - 600Nm (corpo macchina)

- 3 diverse impostazioni di coppia e numero di giri in avvitamento
- Fino a 600Nm di coppia massima in svitamento

• Motore digitale BRUSHLESS (senza spazzole)

- Notevole incremento delle prestazioni fra cui: maggiore potenza, minori consumi di energia, vita utile del motore estesa, miglior dosaggio della potenza dal pulsante
- Attacco quadro maschio da 1/2" con anello trattieni-bussola
- Scatola ingranaggi interamente metallica
- Impugnatura ergonomica antiscivolo
- Selettore avvita-svita-blocco (per il trasporto)
- Luce LED integrata per operare anche in condizioni di scarsa visibilità
- Clip da cintura destra/sinistra
- Fornito in valigetta rigida senza batterie e caricatore

Serraggio

Possibilità di scelta fra 3 differenti impostazioni di coppia e numero di giri (bassa - media - alta):

- 1: 200 Nm; 1000 rpm
- 2: 350 Nm; 1500 rpm
- 3: 550 Nm; 1800 rpm

Disserraggio

- 1: 600 Nm: l'avvitatore applica la coppia massima in continuo (svitamento libero)
- 2: 600 Nm - Autostop: l'avvitatore applica la coppia massima fino allo svitamento totale del dado per poi arrestarsi automaticamente (svitamento a singoli impulsi)



1984 20V/600BMC

€ 322,00 1 019840907

490x370x125 mm - 4,4 kg

1984/K1200

kit avvitatore reversibile ad impulsi 20V BRUSHLESS con attacco 1/2" - 1200Nm

CE

Ideale per applicazioni che richiedono un'elevata coppia di serraggio.

- 3 diverse impostazioni di coppia e numero di giri in avvitamento
- Fino a 1200 Nm di coppia massima in svitamento
- Fino a 1700 Nm di coppia di picco
- **Motore digitale BRUSHLESS (senza spazzole)**
Notevole incremento delle prestazioni fra cui: maggiore potenza, minori consumi di energia, vita utile del motore estesa, miglior dosaggio della potenza dal pulsante
- Attacco quadro maschio da 1/2" con anello trattieni-bussola
- Scatola ingranaggi interamente metallica
- Impugnatura ergonomica antiscivolo
- Selettore avvita-svita-blocco (per il trasporto)
- Luce LED integrata per operare anche in condizioni di scarsa visibilità
- Clip da cintura destra/sinistra

Serraggio

Possibilità di scelta fra 3 differenti impostazioni di coppia e numero di giri (bassa - media - alta):

- 1: 350 Nm; 800 rpm
- 2: 600 Nm; 1400 rpm
- 3: 900 Nm; 1600 rpm

Disserraggio

- 1: 1200 Nm: l'avvitatore applica la coppia massima in continuo (svitamento libero)
- 2: 1200 Nm - Autostop: l'avvitatore applica la coppia massima fino allo svitamento totale del dado per poi arrestarsi automaticamente (svitamento a singolo impulsi)

Fornito in pratica valigetta rigida con 2 batterie agli ioni di litio (6 Ah) e caricatore rapido.

DISPONIBILE
DA MAGGIO

Beta
**3-YEAR
WARRANTY**



1984/K1200

490x370x125 mm - 7 kg

€ 795,00



1



019840120

1984 20V/1200BMC

avvitatore reversibile ad impulsi 20V BRUSHLESS con attacco 1/2" - 1200Nm (corpo macchina)

CE

Ideale per applicazioni che richiedono un'elevata coppia di serraggio.

- 3 diverse impostazioni di coppia e numero di giri in avvitamento
- Fino a 1200Nm di coppia massima in svitamento
- Fino a 1700 Nm di coppia di picco
- **Motore digitale BRUSHLESS (senza spazzole)**
Notevole incremento delle prestazioni fra cui: maggiore potenza, minori consumi di energia, vita utile del motore estesa, miglior dosaggio della potenza dal pulsante
- Attacco quadro maschio da 1/2" con anello trattieni-bussola
- Scatola ingranaggi interamente metallica
- Impugnatura ergonomica antiscivolo
- Selettore avvita-svita-blocco (per il trasporto)
- Luce LED integrata per operare anche in condizioni di scarsa visibilità
- Clip da cintura destra/sinistra
- **Fornito in valigetta rigida senza batterie e caricatore**

Serraggio

Possibilità di scelta fra 3 differenti impostazioni di coppia e numero di giri (bassa - media - alta):

- 1: 350 Nm; 800 rpm
- 2: 600 Nm; 1400 rpm
- 3: 900 Nm; 1600 rpm

Disserraggio

- 1: 1200 Nm: l'avvitatore applica la coppia massima in continuo (svitamento libero)
- 2: 1200 Nm - Autostop: l'avvitatore applica la coppia massima fino allo svitamento totale del dado per poi arrestarsi automaticamente (svitamento a singolo impulsi)

DISPONIBILE
DA MAGGIO

Beta
**3-YEAR
WARRANTY**

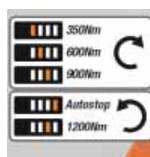

1984 20V/1200BMC

490x370x125 mm - 4,7 kg

€ 375,00



1



019840911

1986/K20V-125

kit smerigliatrice angolare 20V BRUSHLESS

Motore digitale BRUSHLESS (senza spazzole)

Notevole incremento delle prestazioni fra cui: maggiore potenza, minori consumi di energia, vita utile del motore estesa, miglior dosaggio della potenza dal pulsante

Caratteristiche principali

- Protezione contro il riavvio accidentale
- Impugnatura supplementare, posizionabile su entrambi i lati
- Copri disco con sistema "tool-less" (sgancio rapido)
- Dispositivo blocco albero per una rapida sostituzione del disco
- Interruttore di accensione a slitta con blocco
- Feritoie di ventilazione protette contro l'infiltrazione della polvere e per un raffreddamento ottimale
- **Fornita in valigetta rigida con 2 batterie agli ioni di litio da 4 Ah e caricatore rapido**

Dati tecnici

- Diametro disco (non incluso): 125/115 mm
- Velocità libera: 8.000 giri/min
- Filetto albero portautensile: M14

Beta
**3-YEAR
WARRANTY**

DISPONIBILE
DA MAGGIO

CE



1986/K20V-125

€ 571,00 1 019860015

490x370x125 mm - 5,6 kg

1986/20V-125BMC

smerigliatrice angolare 20V BRUSHLESS (corpo macchina)

Motore digitale BRUSHLESS (senza spazzole)

Notevole incremento delle prestazioni fra cui: maggiore potenza, minori consumi di energia, vita utile del motore estesa, miglior dosaggio della potenza dal pulsante

Caratteristiche principali

- Protezione contro il riavvio accidentale
- Impugnatura supplementare, posizionabile su entrambi i lati
- Copri disco con sistema "tool-less" (sgancio rapido)
- Dispositivo blocco albero per una rapida sostituzione del disco
- Interruttore di accensione a slitta con blocco
- Feritoie di ventilazione protette contro l'infiltrazione della polvere e per un raffreddamento ottimale
- **Fornita in valigetta rigida senza batterie e caricatore**

Dati tecnici

- Diametro disco (non incluso): 125/115 mm
- Velocità libera: 8.000 giri/min
- Filetto albero portautensile: M14

Beta
**3-YEAR
WARRANTY**

DISPONIBILE
DA MAGGIO

CE



1986/20V-125BMC

€ 235,00 1 019860025

490x370x125 mm - 3,8 kg



1994B 20V-2AH

batteria agli ioni di litio da 2Ah per utensili 20V

Tecnologia agli ioni di litio di elevata qualità

Dotata di pulsante e 3 LED colorati per il controllo del livello di carica

Caratteristiche principali

- Tensione della batteria 20V
- Capacità della batteria 2Ah
- Capacità energetica 40Wh
- Tipo batteria Li-ion

410 g



DISPONIBILE
DA MAGGIO

CE

1994B 20V-2AH

€ 66,00 1 019940022

1994B 20V-4AH

batteria agli ioni di litio da 4Ah per utensili 20V

Tecnologia agli ioni di litio di elevata qualità

Dotata di pulsante e 3 LED colorati per il controllo del livello di carica

Caratteristiche principali

- Tensione della batteria 20V
- Capacità della batteria 4Ah
- Capacità energetica 80Wh
- Tipo batteria Li-ion

660 g



DISPONIBILE
DA MAGGIO

CE

1994B 20V-4AH

€ 110,00 1 019940044

1994B 20V-6AH

batteria agli ioni di litio da 6Ah per utensili 20V

Tecnologia agli ioni di litio di elevata qualità

Dotata di pulsante e 3 LED colorati per il controllo del livello di carica

Caratteristiche principali

- Tensione della batteria 20V
- Capacità della batteria 6Ah
- Capacità energetica 120Wh
- Tipo batteria Li-ion

900 g



DISPONIBILE
DA MAGGIO

CE

1994B 20V-6AH

€ 152,00 1 019940066

1994C 20V

caricabatteria rapido 20V 110V-240V

Caratteristiche principali:

- Indicatore LED di stato di carica
- Tensione di ingresso nominale: 110V-240V ~ 50/60Hz
- Voltaggio in uscita: 20V
- Corrente di carica: 6A
- Potenza di ingresso nominale: 145W

Tempo di ricarica batteria 20V da 2Ah: 45 min

Tempo di ricarica batteria 20V da 4Ah: 90 min

Tempo di ricarica batteria 20V da 6Ah: 120 min

680 g



DISPONIBILE
DA MAGGIO

CE

1994C 20V

€ 116,00 1 019940140

1989RCB

radio da cantiere 20V

CE

Intrattenimento audio multifunzione: radio digitale (DAB; BT v5.3) e convenzionale FM

Idonea per l'utilizzo in cantiere o per il tempo libero

Radio robusta dal design compatto e moderno, con grado di protezione IP54

Potente suono stereo grazie ai due potenti altoparlanti laterali da 16W

Funzione allarme-sveglia integrata

Completa di maniglia per il trasporto e protezioni angolari antiurto

Dotata di una connessione AUX e un connettore USB protetto per il

collegamento e la ricarica del telefono

Può essere utilizzata con batterie Beta da 20V (optional) o con cavo di alimentazione elettrica incluso nella confezione.

Caratteristiche principali:

- Range frequenza radio FM: 87.5 – 108 MHz
- Range frequenza radio DAB: 174 – 240 MHz
- Numero di stazioni FM e DAB memorizzabili: 20
- Potenza altoparlanti: 16W
- Tensione nominale della batteria (optional): 20V
- Dimensioni radio: 180 x 205 x 305 mm
- Peso radio (senza batteria): 3,2 kg

DISPONIBILE
DA MAGGIO



1989RCB

€ 340,00 1 019890020

C9PT

borsa in tessuto tecnico per utensili a batteria

Perfetta per trasportare comodamente gli elettroattrezzi Beta

Realizzata con tessuto tecnico ad altissima resistenza

Doppia maniglia superiore per una presa bilanciata e sicura

DISPONIBILE
DA MAGGIO



C9PT

€ 42,00 1 021090001

400x210x290 mm - 2,4 kg

Beta



La gamma di utensili a filo include **smerigliatrici angolari, trapani (a percussione e tassellatore), aspiratori per solidi e liquidi, pistole termiche e pistola per colla a caldo.**

In particolar modo le smerigliatrici angolari Beta (da 750W a 2400W di potenza) riscuotono un crescente successo grazie alle seguenti caratteristiche costruttive:

• **Massime prestazioni:**

- Potente motore resinato resistente all'usura e di lunga durata
- Feritoie di ventilazione per un raffreddamento ottimale, protette contro l'infiltrazione della polvere

• **Massima sicurezza per l'operatore:**

- Dispositivo blocco albero per una rapida sostituzione dei dischi
- Protezione contro il riavvio accidentale
- Avviamento graduale con limitazione dello spunto alla partenza

• **Massimo comfort e maneggevolezza:**

- Impugnatura ergonomica antiscivolo per una presa più salda
- Testa ribassata per operare in spazi ristretti

Ben 4 metri di lunghezza cavo antigroviglio per una comoda autonomia di movimento.

Impugnatura supplementare posizionabile su entrambi i lati.

1956 115-750W

smerigliatrice angolare per dischi Ø 115 mm

Ideale per lavori di taglio, rettifica e sgrossatura

Potente motore da 750 W

Impugnatura ergonomica antiscivolo per maggiore comfort e sicurezza
Testa ribassata per operare in spazi ristretti
Estremamente leggera, solo 1,8kg di peso

Caratteristiche principali

- Protezione contro il riavvio accidentale
- Impugnatura supplementare, posizionabile su entrambi i lati
- Copri disco con sistema "tool-less" (sgancio rapido)
- Dispositivo blocco albero per una rapida sostituzione del disco
- Interruttore di accensione a slitta con blocco
- Feritoie di ventilazione protette contro l'infiltrazione della polvere e per un raffreddamento ottimale
- Chiave di servizio inclusa

1,8 kg



1956 125-1400W

smerigliatrice angolare per dischi Ø 125mm

CE

Ideale per lavori di taglio, rettifica e sgrossatura

L = 4 m

Potente motore da 1400 W - Velocità variabile

Impugnatura ergonomica antiscivolo per maggiore comfort e sicurezza

Testa ribassata per operare in spazi ristretti

Caratteristiche principali

- Protezione contro il riavvio accidentale
- Impugnatura supplementare **Antivibrazione**, posizionabile su entrambi i lati
- Copri disco con sistema "tool-less" (sgancio rapido)
- Dispositivo blocco albero per una rapida sostituzione del disco
- Interruttore di accensione a slitta con blocco
- Feritoie di ventilazione protette contro l'infiltrazione della polvere e per un raffreddamento ottimale
- Chiave di servizio in dotazione

📦 2,5 kg



1956 125-1400W

€ 158,00 1 019560125

1956 230-2400W

smerigliatrice angolare per dischi Ø 230 mm

CE

Ideale per lavori complessi di troncatura, smerigliatura e limatura

Potente motore da 2400 W

Impugnatura ergonomica antiscivolo per maggiore comfort e sicurezza

Caratteristiche principali

- Protezione contro il riavvio accidentale
- Funzione **Soft Start** per un avviamento lento e limitazione dello spunto alla partenza
- Impugnatura supplementare **Antivibrazione**, posizionabile su entrambi i lati
- Copri disco con sistema di chiusura a vite
- Dispositivo blocco albero per una rapida sostituzione del disco
- Interruttore di accensione a slitta con blocco
- Feritoie di ventilazione protette contro l'infiltrazione della polvere e per un raffreddamento ottimale
- Chiave di servizio inclusa

📦 5,8 kg



1956 230-2400W

€ 213,00 1 019560230

1966/910W

trapano a percussione da 910W

CE

Ideale per forare diversi materiali quali legno, metallo, plastica, muratura e calcestruzzo

Potente motore da 910W

Design lineare e compatto con impugnatura ergonomica anti-scivolo

Mandrino autoserrante in metallo da 13 mm

Velocità variabile con reversibilità

Scatola ingranaggi interamente metallica

Blocco dell'interruttore per un maggiore comfort d'utilizzo

Caratteristiche principali:

- Diametro max foratura legno 32 mm
- Diametro max foratura metallo 13 mm
- Diametro max foratura muratura 13 mm
- Velocità a vuoto 0-2800 giri/min
- Lunghezza cavo di alimentazione antigroviglio 4 m

Accessori in dotazione:

- Mandrino autoserrante in metallo da 13 mm
- Impugnatura laterale aggiuntiva orientabile a 360°
- Asta di profondità

DISPONIBILE
DA MAGGIO



1966/910W

€ 130,00 1 019660091

420x320x120 mm - 4,3 kg

1967/800W

martello tassellatore SDS-PLUS da 800W

CE

Ideale per applicazioni di foratura, tassellatura e scalpellatura in muratura, calcestruzzo, piastrelle, legno e metallo

Potente motore da 800W per le applicazioni più gravose

Professionale, leggero e potente

Design ergonomico e compatto, per operare anche in spazi angusti e ristretti

Caratteristiche principali

3 modalità di utilizzo + funzione Vario-Lock:

- funzione trapano
- funzione martello
- funzione scalpello
- funzione vario-lock: per scegliere fra 36 posizioni di scalpellatura e ottenere l'angolazione di lavoro ottimale

Diametro max foratura legno 30 mm

Diametro max foratura metallo 13 mm

Diametro max foratura calcestruzzo 26 mm

Reversibile

Frizione di sicurezza

Potenza del colpo 3,2J

Velocità a vuoto 0-1350 giri/min

Numero di colpi 0-5700 colpi/min

Lunghezza cavo di alimentazione antigroviglio 4 m

Accessori in dotazione:

- Mandrino da 13 mm con attacco SDS-PLUS
- Impugnatura laterale aggiuntiva orientabile a 360°
- Asta di profondità
- 3 punte da muro Ø 8-10-12 mm, lunghezza 150mm
- 1 scalpello a lama piatta 14x250 mm
- 1 scalpello a punta 14x250 mm

DISPONIBILE
DA MAGGIO



1967/800W

€ 187,00 1 019670080

420x300x115 mm - 5,2 kg



1850D

pistola termica 3 velocità

- Pos. I 250 l/min 50°C
- Pos. II 250 l/min 400°C
- Pos. III 500 l/min 550°C
- 4 ugelli inclusi



1850D	L mm 255	H mm 210	€ 138,00	1	018500018
-------	----------------	----------------	-------------	---	-----------

1850E

pistola termica
con regolazione elettronica

- Pos. I 250-500 l/min 50°C
- Pos. II 250-500 l/min 50-650°C

- Display digitale.
- Pulsanti regolazione temperatura e portata del flusso.
- 4 programmi memorizzati in origine e possibilità di personalizzazioni
- 4 ugelli inclusi

- Prog 1 150°C ca. 400 l/min
- Prog 2 200°C ca. 400 l/min
- Prog 3 300°C ca. 450 l/min
- Prog 4 400°C ca. 500 l/min



1850E	L mm 255	H mm 210	€ 289,00	1	018500020
-------	----------------	----------------	-------------	---	-----------

1851VK

pistola per colla a caldo con 12 stick di colla termofusibile in valigetta

- potenza 80 watt
- per colla in stick ø 11 e 12 mm

CE



1851VK	€ 57,00	1	018510058
--------	------------	---	-----------

320x250x50 mm

1851VK-12C

12 stick di colla termofusibile

Ø 11 mm



1851VK-12C	€ 14,60	1	018510062
------------	------------	---	-----------

1851VK-12V

12 stick di colla termofusibile
per superfici verniciate

Ø 11 mm



1851VK-12V	€ 14,60	1	018510072
------------	------------	---	-----------

1870

aspiratore 20 litri per solidi e liquidi

- motore by-pass monostadio
- tensione 220/240 V
- frequenza 50/60 Hz
- potenza Max 1200 W
- portata d'aria l/sec. 58
- depressione Max 190 mbar
- capienza Max bidone 20 l in PP antistatico
- emissioni acustiche <70 dB(A)
- lunghezza cavo 5 m
- carrello porta accessori

ACCESSORI IN DOTAZIONE Ø 36 mm

- 1 tubo corrugato completo di impugnatura ergonomica
- 2 tubi rigidi di prolunga
- 1 spazzola multiuso per pavimenti e liquidi
- 1 bocchetta a lancia

SISTEMI FILTRANTI

- 1 cartuccia filtro aria superficiale 1900 cm² - 12 micron nom.
- 1 filtro anti-schiuma PPI 45/PPI 30

CE



IPX4

1870	€ 246,00	1	018700020
------	-------------	---	-----------

1870I

aspiratore 20 litri per solidi e liquidi,
bidone in acciaio INOX

- motore by-pass monostadio
- tensione 220/240 V
- frequenza 50/60 Hz
- potenza Max 1200 W
- portata d'aria l/sec. 58
- depressione Max 190 mbar
- capienza Max bidone 20 l in acciaio INOX
- emissioni acustiche <70 dB(A)
- lunghezza cavo 5 m

ACCESSORI IN DOTAZIONE Ø 36 mm

- 1 tubo corrugato completo di impugnatura ergonomica con sfianto
- 2 tubi rigidi di prolunga
- 1 spazzola multiuso per pavimenti e liquidi
- 1 bocchetta a lancia
- 1 sacco in carta

SISTEMI FILTRANTI

- 1 cartuccia filtro aria superficiale 1900 cm² - 12 micron nom.
- 1 filtro anti-schiuma PPI 45/PPI 30

CE



IPX4

1870I	€ 274,00	1	018700020
-------	-------------	---	-----------

1872L

aspiratore 35 litri per solidi e liquidi

classe certificata "L"

- motore by-pass bistadio
- tensione 220/240 V
- frequenza 50/60 Hz
- potenza Max 1100 W
- portata d'aria l/sec. 55
- depressione Max 220 mbar
- capienza Max bidone 35 l in PE-HD antistatico
- emissioni acustiche <70 dB(A)
- lunghezza cavo 6 m

ACCESSORI IN DOTAZIONE Ø 36 mm

- 1 tubo corrugato completo di impugnatura ergonomica
- 2 tubi di prolunga in plastica
- 1 telaio spazzola combinata
- 1 inserto con gomme raccogli liquidi
- 1 bocchetta a lancia

SISTEMI FILTRANTI

- 1 sacco in tessuto non tessuto classe di filtraggio "L"
- 1 cartuccia filtro classificata IFA classe "L"
- 1 filtro anti-schiuma PPI 45/PPI 30
- 2 post-filtri in PET accoppiato a PP

CE



IPX4

1872L 35 € 537,00 1 018720135

1873

aspiratore 30 litri per solidi e liquidi,
bidone in acciaio INOX

- motore by-pass bistadio
- tensione 220/240 V • frequenza 50/60 Hz
- potenza Max 1100 W • portata d'aria l/sec. 55
- depressione Max 220 mbar
- capienza Max bidone 30 l in acciaio Inox
- emissioni acustiche <61 dB(A)
- lunghezza cavo 6 m

carrello porta accessori

ACCESSORI IN DOTAZIONE Ø 45mm

- 1 tubo corrugato completo di impugnatura ergonomica
- 2 tubi di prolunga in acciaio inox
- 1 telaio spazzola industriale • 1 inserto industriale moquette
- 1 inserto industriale con gomme raccogli liquidi
- 1 bocchetta a lancia

SISTEMI FILTRANTI

- 1 sacco in carta filtro
- 1 cartuccia filtro superficiale 1900 cm² 12 micron nom.
- 1 filtro anti-schiuma PPI 45/PPI 30

CE



1873 30 € 716,00 1 018730030

1874

aspiratore 50 litri per solidi e liquidi,
bidone in acciaio INOX

- motore by-pass bistadio
- tensione 220/240 V • frequenza 50/60 Hz
- potenza Max 1350 W • portata d'aria l/sec. 55
- depressione Max 240 mbar
- capienza Max bidone 50 l in acciaio Inox
- emissioni acustiche <63 dB(A)
- lunghezza cavo 6 m

carrello porta accessori

ACCESSORI IN DOTAZIONE Ø 45mm

- 1 tubo corrugato completo di impugnatura ergonomica
- 2 tubi di prolunga in acciaio inox
- 1 telaio spazzola industriale
- 1 inserto industriale moquette
- 1 inserto industriale con gomme raccogli liquidi
- 1 bocchetta a lancia

SISTEMI FILTRANTI

- 1 sacco in carta filtro
- 1 cartuccia filtro superficiale 5200 cm² 12 micron nom.
- 1 filtro anti-schiuma PPI 45/PPI 30

CE



1874 50 € 904,00 1 018740050

1870-20/5S

5 sacchi orizzontali in carta per
1870-1870I-1875LT



1870 20/5S € 56,00 1 018700021

1870-72 /FC

filtro a cartuccia 1900 cm² 12 micron nominali
per 1870 - 1870I - 1873 - 1875LT



1870/FC € 48,00 1 018700026

1870-72/FL

filtro per aspirazione liquidi
per 1870 - 1870I - 1872L - 1873 - 1874 -
1875LT



1870 72/FL € 17,70 1 018700027

1872L 35/FC

filtro a cartuccia classe "L"
per 1872L



1872L 35/FC € 58,00 1 018720144

1872L 35/5S

5 sacchi in tessuto non tessuto classe "L"
per 1872L- 1873



1872L 35/5S € 88,50 1 018720136

1873-30/5S

5 sacchi in carta verticali per 1873



1873 30/5S € 56,00 1 018730031

1874-50/5S

5 sacchi verticale per 1874



1874 50/5S € 71,00 1 018740051

1874-50/FC

filtro a cartuccia 5200 cm² 12 micron nominali
per 1874



1874 50/FC € 57,50 1 018740056



UTENSILI PNEUMATICI

Da oltre 20 anni Beta Utensili ha ampliato la propria offerta con una gamma completa di utensili pneumatici e accessori destinati al mercato automotive e alla manutenzione industriale: avvitatori, cricchetti, trapani, smerigliatrici, levigatrici e molti altri articoli. Nel corso di questo periodo la stretta collaborazione con gli utilizzatori professionisti è stata fondamentale per una crescita costante. È grazie a questa crescita che oggi il mercato riconosce negli utensili pneumatici Beta un ottimo rapporto affidabilità/prestazioni.

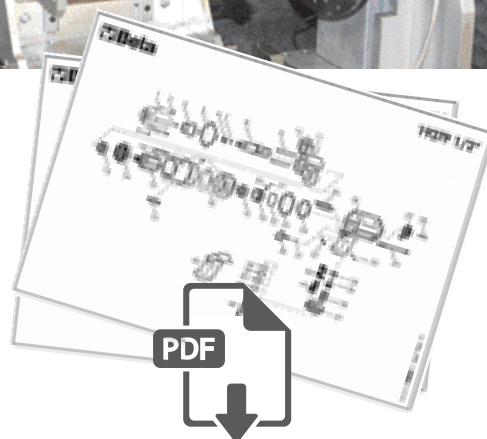
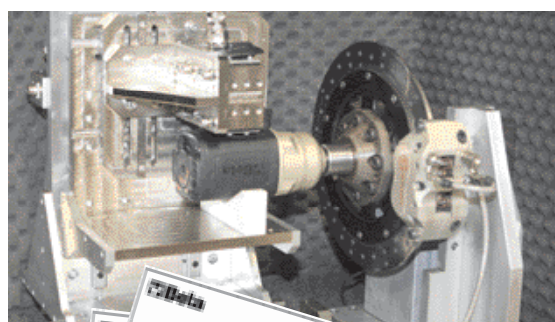

Beta Utensili, con l'obiettivo di soddisfare al meglio le richieste del mercato, effettua le riparazioni degli articoli pneumatici all'interno del proprio Ufficio Qualità. Questo processo ha consentito all'azienda di incrementare notevolmente il proprio know-how e di essere sempre più reattiva nei confronti della clientela.





www.beta-tools.com

GUIDA ALLA SCELTA UTENSILI PNEUMATICI













GAMMA AVVITATORI

■	ARTICOLO	CODICE	MATERIALE	 max. Nm	 db (A) LpA	 db (A) LpW	 /min.	 kg	MECCANISMO	 m/s ²
3/8"		1924F	Alluminio	108	93,6	104,6	59	0,5	Doppio martello	6,85
3/8"		1924B	Alluminio	353	91	95	80	1,5	Pin clutch	7,9
3/8"		1924CD	Composito	410	91,7	102,7	79	1,3	Doppio martello	6,2
3/8"		1924XM	Composito	515	91,7	102,7	122	1,3	Singolo martello	6,2
1/2"		1927AN	Alluminio	244	89,4	100,4	190	2,1	Singolo martello	8,63
1/2"		1927G	Alluminio	325	92,2	103,2	113	1,2	Singolo martello	9,96
1/2"		1927B	Alluminio	705	98,0	109,0	133	2,1	Pin clutch	14,08
1/2"		1927XM	Alluminio	770	102	113	122	1,3	Singolo martello	7,5
1/2"		1927CD	Composito	1.020	95,5	106,5	130	2,3	Doppio martello	7,2
1/2"		1927P	Composito	1.750	95,1	106,1	290	2,0	Doppio martello	6,7
3/4"		1928XM	Alluminio	1.600	91,8	102,8	175	2,9	Doppio martello	12,96
3/4"		1928DA	Alluminio	1.695	96	99,5	300	4,3	Doppio martello	3,6
3/4"		1928DAL	Alluminio	1.695	96	99,5	300	4,8	Doppio martello	3,6
3/4"		1928CD	Composito	1.800	97,5	108,5	215	3,5	Doppio martello	11,4
3/4"		1928P	Composito	2.100	96,2	107,2	221	3,7	Doppio martello	7,6
1"		1930CD	Composito	2.445	95,6	97,1	410	7,1	Doppio martello	3,6
1"		1930PA	Alluminio	2.445	96,0	97,1	410	9,6	Doppio martello	7,2
1"		1930A	Alluminio	2.445	103,3	114,3	460	9,5	Doppio martello	67
1"		1930LH	Alluminio	2.441	97,1	108,1	282	7,1	Doppio martello	17,4
1"		1930LA	Alluminio	2.445	95,6	97,1	460	10,6	Doppio martello	3,6

GUIDA ALLA SCELTA UTENSILI PNEUMATICI

■	ARTICOLO	CODICE	MATERIALE	max. Nm	db (A) LpA	db (A) LpW	l/min.	kg	MECCANISMO	m/s ²
1"		1930HLA	Alluminio	3.661	99	101	460	16,4	Doppio martello	16,4
1 1/2"		1930ZL	Alluminio	4.068	102,4	113,4	480	15	Doppio martello	69.6

GAMMA AVVITATORI A CRICCHETTO

■	ARTICOLO	CODICE	 max. Nm	 db (A) LpA	 db (A) LpW	 l/min.	 kg	 m/s ²
14"		1921B1	24	96	85	90	0,4	2.6
14"		1921M1	27	84	88	96	0,6	1.8
14"		1922P1	68	90,6	101,6	88	0,6	8.61
3/8"		1921M2	27	84	88	96	0,6	1.8
3/8"		1922P2	68	90,6	101,6	88	0,6	8.61
12"		1921N3	68	80	87	140	1,2	2.6
12"		1922P3	136	94,9	105,9	113	1,5	18.28

GAMMA SMERIGLIATRICI

	ARTICOLO	CODICE	POTENZA	 db (A) LpA	 db (A) LpW	 l/min.	 kg	 m/s ²
		1933	0,20 kW	80,0	87,0	230	0,38	4,53
		1933L	0,20 kW	80,0	87,0	270	0,67	1,15
		1933AN90	0,20 kW	80,0	87,0	230	0,51	1,24
		1933I	0,38 kW	80,0	87,0	260	0,67	4,53
		1933IL	0,38 kW	79,0	97,0	113	1,4	1,6
		1933IH	0,75 kW	88,1	99,1	370	0,8	2,6
		1933ILH	0,75 kW	85,7	96,7	370	1,2	1,4
		1933AN90-H	0,75 kW	85,6	96,6	370	1,1	6,7
		1934MAV	0,04 kW	71	76	115	0,2	2,5
		1934MAV70	0,08 kW	80	87	115	0,2	4

1921B1

baby cricchetto reversibile

1/4"

CE



130 mm

Velocità libera	350 giri/min
Coppia massima	24 Nm
Capacità vite/dado	Cl 8.8 M7●11 mm
Capacità vite/dado	Cl 12.9 M6●10 mm
Attacco aria	1/4" GAS
Pressione di utilizzo	6,2 bar
Ø interno tubo aria	8 mm
Consumo aria medio	68 l/min
Peso	0,4 kg

1/4 € 259,00 1 019210001

1921M1

cricchetto compatto reversibile

• Regolatore di velocità mediante manopola

1/4"

CE



198 mm

Velocità libera	200 giri/min
Coppia massima	27 Nm
Capacità vite/dado	Cl 8.8 M7●11 mm
Capacità vite/dado	Cl 12.9 M6●10 mm
Attacco aria	1/4" GAS
Pressione di utilizzo	6,2 bar
Ø interno tubo aria	8 mm
Consumo aria medio	96 l/min
Peso	0,6 kg

1/4 kg 0,6 € 228,50 1 019210005

1921M2

cricchetto compatto reversibile

• Regolatore di velocità mediante manopola

3/8"

CE



198 mm

Velocità libera	200 giri/min
Coppia massima	27 Nm
Capacità vite/dado	Cl 8.8 M7●11 mm
Capacità vite/dado	Cl 12.9 M6●10 mm
Attacco aria	1/4" GAS
Pressione di utilizzo	6,2 bar
Ø interno tubo aria	8 mm
Consumo aria medio	96 l/min
Peso	0,6 kg

3/8 kg 0,6 € 228,50 1 019210015

1921N3

cricchetto reversibile

• Regolatore di velocità mediante manopola

1/2"

CE



258 mm

Velocità libera	150 giri/min
Coppia massima	68 Nm
Capacità vite/dado	Cl 8.8 M10●16 mm
Capacità vite/dado	Cl 12.9 M8●13 mm
Attacco aria	1/4" GAS
Pressione di utilizzo	6,2 bar
Ø interno tubo aria	10 mm
Consumo aria medio	140 l/min
Peso	1,2 kg

1/2 kg 1,2 € 228,50 1 019210025

1922P1

cricchetto reversibile a massa battente

• Meccanismo impulsivo "Doppio rocking dog"

1/4"

CE



164 mm

Velocità libera	700 giri/min
Coppia massima	68 Nm
Capacità vite/dado	Cl 8.8 M10●16 mm
Capacità vite/dado	Cl 12.9 M8●13 mm
Attacco aria	1/4" GAS
Pressione di utilizzo	6,2 bar
Ø interno tubo aria	10 mm
Consumo aria medio	88 l/min
Peso	0,6 kg

1/4 kg 0,6 € 277,00 1 019220006

1922P2

cricchetto reversibile a massa battente

• Meccanismo impulsivo "Doppio rocking dog"

3/8"

CE



164 mm

Velocità libera	700 giri/min
Coppia massima	68 Nm
Capacità vite/dado	Cl 8.8 M10●16 mm
Capacità vite/dado	Cl 12.9 M8●13 mm
Attacco aria	1/4" GAS
Pressione di utilizzo	6,2 bar
Ø interno tubo aria	10 mm
Consumo aria medio	88 l/min
Peso	0,6 kg

3/8 kg 0,6 € 277,00 1 019220010

1922P3

cricchetto reversibile a massa battente

• Meccanismo impulsivo "Doppio rocking dog"

1/2"

CE



292 mm

Velocità libera	600 giri/min
Coppia massima	136 Nm
Capacità vite/dado	Cl 8.8 M12●18 mm
Capacità vite/dado	Cl 12.9 M10●16 mm
Attacco aria	1/4" GAS
Pressione di utilizzo	6,2 bar
Ø interno tubo aria	10 mm
Consumo aria medio	113 l/min
Peso	1,5 kg

1/2 kg 1,5 € 437,00 1 019220013

1924F

avvitatore reversibile compatto "butterfly"

• Meccanismo impulsivo "Doppio rocking dog"

3/8"

CE



139 mm

Velocità libera	12.000 giri/min
Coppia massima	108 Nm
Capacità vite/dado	Cl 8.8 M12●18 mm
Capacità vite/dado	Cl 12.9 M10●16 mm
Attacco aria	1/4" GAS
Pressione di utilizzo	6,2 bar
Ø interno tubo aria	10 mm
Consumo aria medio	59 l/min
Peso	0,5 kg

3/8 kg 0,5 € 256,00 1 019240025



1924B

avvitatore reversibile compatto

• Meccanismo impulsivo "Pin Clutch"



Velocità libera	10.000 giri/min
Coppia massima	353 Nm
Capacità vite/dado	Cl 8.8 M16●24 mm
Capacità vite/dado	Cl 12.9 M14●21 mm
Attacco aria	1/4" GAS
Pressione di utilizzo	6,2 bar
Ø interno tubo aria	8 mm
Consumo aria medio	80 l/min
Peso	1,5 kg

3/8	kg	€	1	019240021
1,5		294,00		

1924XM

avvitatore reversibile compatto

• Meccanismo impulsivo singolo martello



Velocità libera	9.000 giri/min
Coppia massima	515 Nm
Capacità vite/dado	Cl 8.8 M16●24 mm
Capacità vite/dado	Cl 12.9 M14●21 mm
Attacco aria	1/4" GAS
Pressione di utilizzo	6,2 bar
Ø interno tubo aria	10 mm
Consumo aria medio	122 l/min
Peso	1,3 kg

3/8	kg	€	1	019240030
1,3		284,00		

1927B

avvitatore reversibile

• Meccanismo impulsivo "Pin Clutch"



Velocità libera	7.000 giri/min
Coppia massima	705 Nm
Capacità vite/dado	Cl 8.8 M22●34 mm
Capacità vite/dado	Cl 12.9 M18●27 mm
Attacco aria	1/4" GAS
Pressione di utilizzo	6,2 bar
Ø interno tubo aria	10 mm
Consumo aria medio	133 l/min
Peso	2,1 kg

1/2	kg	€	1	019270022
2,1		198,00		

1924CD

avvitatore reversibile in materiale composito

• Meccanismo impulsivo doppio martello



Velocità libera	10.000 giri/min
Coppia massima	410 Nm
Capacità vite/dado	Cl 8.8 M16●24 mm
Capacità vite/dado	Cl 12.9 M14●21 mm
Attacco aria	1/4" GAS
Pressione di utilizzo	6,2 bar
Ø interno tubo aria	8 mm
Consumo aria medio	79 l/min
Peso	1,3 kg

3/8	kg	€	1	019240007
1,3		400,00		



1927B/K5

avvitatore reversibile in alluminio fornito con 5 bussole macchina, in valigetta



Velocità libera	7.000 giri/min
Coppia massima	705 Nm
Capacità vite/dado	Cl 8.8 M22●34 mm
Capacità vite/dado	Cl 12.9 M18●27 mm
Attacco aria	1/4" GAS
Pressione di utilizzo	6,2 Bar
Ø interno tubo aria	10 mm
Consumo aria medio	133 l/min

1/2	kg	€	1	019270122
3,5		261,00		
350x305x86 mm				

1927CD

avvitatore reversibile in materiale composito

- Meccanismo impulsivo doppio martello



Velocità libera	7.000 giri/min
Coppia massima	1.020 Nm
Capacità vite/dado	Cl 8.8 M22●34 mm
Capacità vite/dado	Cl 12.9 M18●27 mm
Attacco aria	1/4" GAS
Pressione di utilizzo	6,2 bar
Ø interno tubo aria	10 mm
Consumo aria medio	130 l/min
Peso	2,3 kg

1/2 2,3 € 464,00 1 019270007

1927P

avvitatore reversibile in materiale composito

- Meccanismo impulsivo doppio martello



Velocità libera	7.500 giri/min
Coppia massima	1.750 Nm
Capacità vite/dado	Cl 8.8 M24●36 mm
Capacità vite/dado	Cl 12.9 M20●30 mm
Attacco aria	1/4" GAS
Pressione di utilizzo	6,2 bar
Ø interno tubo aria	10 mm
Consumo aria medio	290 l/min
Peso	2 kg

1/2 2,0 € 504,00 1 019270008

1927XM

avvitatore reversibile compatto

- Meccanismo impulsivo singolo martello



Velocità libera	10.000 giri/min
Coppia massima	770 Nm
Capacità vite/dado	Cl 8.8 M22●34 mm
Capacità vite/dado	Cl 12.9 M18●27 mm
Attacco aria	1/4" GAS
Pressione di utilizzo	6,2 bar
Ø interno tubo aria	10 mm
Consumo aria medio	122 l/min
Peso	1,3 kg

1/2 1,3 € 302,00 1 019270030

1927CD/K3

assortimento di un avvitatore reversibile e tre bussole Macchina

- Meccanismo impulsivo doppio martello



720LC17-19-21 mm

Velocità libera	7.000 giri/min
Coppia massima	1.020 Nm
Capacità vite/dado	Cl 8.8 M22●34 mm
Capacità vite/dado	Cl 12.9 M18●27 mm
Attacco aria	1/4" GAS
Pressione di utilizzo	6,2 Bar
Ø interno tubo aria	10 mm
Consumo aria medio	130 l/min

1/2 4 € 519,00 1 019270107
350x305x86 mm

1927P/K3

avvitatore reversibile in materiale composito fornito con 3 bussole Macchina



720LC17-19-21 mm

Velocità libera	7.500 giri/min
Coppia massima	1.750 Nm
Capacità vite/dado	Cl 8.8 M24●36 mm
Capacità vite/dado	Cl 12.9 M20●30 mm
Attacco aria	1/4" GAS
Pressione di utilizzo	6,2 Bar
Ø interno tubo aria	10 mm
Consumo aria medio	290 l/min

1/2 4 € 588,00 1 019270118
350x305x86 mm

1927XM/K5

assortimento di un avvitatore reversibile compatto e cinque bussole Macchina

- Meccanismo impulsivo singolo martello



720 17-19-21-22-24 mm

Velocità libera	10.000 giri/min
Coppia massima	770 Nm
Capacità vite/dado	Cl 8.8 M22●34 mm
Capacità vite/dado	Cl 12.9 M18●27 mm
Attacco aria	1/4" GAS
Pressione di utilizzo	6,2 Bar
Ø interno tubo aria	10 mm
Consumo aria medio	122 l/min

1/2 2,8 € 367,00 1 019270129
307x206x86 mm

1927AN

avvitatore reversibile angolare

- Meccanismo impulsivo singolo martello

12"

CE



Velocità libera	4.700 giri/min
Coppia massima	244 Nm
Capacità vite/dado	CI 8.8 M14●21 mm
Capacità vite/dado	CI 12.9 M12●19 mm
Attacco aria	1/4" GAS
Pressione di utilizzo	6,2 bar
Ø interno tubo aria	10 mm
Consumo aria medio	190 l/min
Peso	2,1 kg

1/2"	kg	€	1	019270012
	2,1	533,00		

1927G

avvitatore reversibile compatto

- Meccanismo impulsivo singolo martello

12"

CE



Velocità libera	8500 giri/min
Coppia massima	325 Nm
Capacità vite/dado	CI 8.8 M16●24 mm
Capacità vite/dado	CI 12.9 M14●21 mm
Attacco aria	1/4" GAS
Pressione di utilizzo	6,2 bar
Ø interno tubo aria	10 mm
Consumo aria medio	113 l/min
Peso	1,2 kg

1/2"	kg	€	1	019270050
	1,2	438,00		

1927SP-AM

supporto magnetico per avvitatore pneumatico

- Dotato di due magneti ad alta tenuta con gomma protettiva
- Permette di alloggiare 1 avvitatore da 1/2", 4 bussole e 1 chiave dinamometrica
- Portata: 10 kg



g	€	1	019270000
400	65,00		

1928DA

avvitatore reversibile

- Meccanismo impulsivo doppio martello

3/4"

CE



Velocità libera	5.000 giri/min
Coppia massima	1.695 Nm
Capacità vite/dado	CI 8.8 M30●46 mm
Capacità vite/dado	CI 12.9 M27●41 mm
Attacco aria	3/8" GAS
Pressione di utilizzo	6,2 bar
Ø interno tubo aria	10 mm
Consumo aria medio	240 l/min
Peso	4,3 kg

3/4"	kg	€	1	019280022
	4,3	865,00		

1928DAL

avvitatore reversibile

- Meccanismo impulsivo doppio martello

3/4"

CE



Velocità libera	5.000 giri/min
Coppia massima	1.695 Nm
Capacità vite/dado	CI 8.8 M27●41 mm
Capacità vite/dado	CI 12.9 M24●36 mm
Attacco aria	3/8" GAS
Pressione di utilizzo	6,2 bar
Ø interno tubo aria	10 mm
Consumo aria medio	240 l/min
Peso	4,8 kg

3/4"	kg	€	1	019280023
	4,8	928,00		

1928K4

assortimento di un avvitatore reversibile e quattro bussole Macchina serie lunga

- Meccanismo impulsivo "Pin Clutch"

3/4"

CE



728L 27-30-32-36 mm

Velocità libera	4.000 giri/min
Coppia massima	1.493 Nm
Capacità vite/dado	CI 8.8 M27●41 mm
Capacità vite/dado	CI 12.9 M24●36 mm
Attacco aria	3/8" GAS BSP
Pressione di utilizzo	6,2 bar
Ø interno tubo aria	10 mm
Consumo aria medio	260 l/min
Peso avvitatore	5,2 kg

3/4"	kg	€	1	019280104
	9,3	883,00		
410x330x106 mm				

1928XM

avvitatore reversibile compatto

- Meccanismo impulsivo doppio martello
- Incredibilmente compatto e potente
- Comando d'inversione a leva azionabile con una sola mano
- Tre differenti livelli di potenza in avvitamento
- Scarico dell'aria attraverso l'impugnatura

3/4"

CE



Velocità libera	4.800 giri/min
Coppia massima	1.600 Nm
Capacità vite/dado	CI 8.8 M27●41 mm
Capacità vite/dado	CI 12.9 M24●36 mm
Attacco aria	3/8" GAS
Pressione di utilizzo	6,2 bar
Ø interno tubo aria	10 mm
Consumo aria medio	175 l/min
Peso	2,9 kg

3/4"	kg	€	1	019280030
	2,9	598,00		

1928CD

avvitatore reversibile in materiale composito

- Meccanismo impulsivo doppio martello



Velocità libera	4.500 giri/min
Coppia massima	1.800 Nm
Capacità vite/dado	Cl 8.8 M27 ● 41 mm
Capacità vite/dado	Cl 12.9 M24 ● 36 mm
Attacco aria	3/8" GAS
Pressione di utilizzo	6,2 bar
Ø interno tubo aria	10 mm
Consumo aria medio	215 l/min
Peso	3,5 kg

3/4 kg 3,5 € 1.111,00 1 019280007

1928P

avvitatore reversibile in materiale composito

- Meccanismo impulsivo doppio martello



Velocità libera	5.000 giri/min
Coppia massima	2.100 Nm
Capacità vite/dado	Cl 8.8 M30 ● 46 mm
Capacità vite/dado	Cl 12.9 M27 ● 41 mm
Attacco aria	3/8" GAS
Pressione di utilizzo	6,2 bar
Ø interno tubo aria	10 mm
Consumo aria medio	221 l/min
Peso	3,7 kg

3/4 kg 3,7 € 1.190,00 1 019280006

1930LH

avvitatore reversibile

- Meccanismo impulsivo doppio martello



Velocità libera	6.000 giri/min
Coppia massima	2.441 Nm
Capacità vite/dado	Cl 8.8 M36 ● 55 mm
Capacità vite/dado	Cl 12.9 M30 ● 46 mm
Attacco aria	1/2" GAS
Pressione di utilizzo	6,2 bar
Ø interno tubo aria	13 mm
Consumo aria medio	280 l/min
Peso	7,1 kg

1 kg 7,1 € 1.335,00 1 019300030

1930CD

avvitatore reversibile in materiale composito

- Meccanismo impulsivo doppio martello



Velocità libera	4.000 giri/min
Coppia massima	2.445 Nm
Capacità vite/dado	Cl 8.8 M36 ● 55 mm
Capacità vite/dado	Cl 12.9 M30 ● 46 mm
Attacco aria	1/2" GAS
Pressione di utilizzo	6,2 bar
Ø interno tubo aria	13 mm
Consumo aria medio	320 l/min
Peso	7,1 kg

1 kg 7,1 € 1.435,00 1 019300022

1930PA

avvitatore reversibile

- Meccanismo impulsivo doppio martello



Velocità libera	3.500 giri/min
Coppia massima	2.445 Nm
Capacità vite/dado	Cl 8.8 M36 ● 55 mm
Capacità vite/dado	Cl 12.9 M30 ● 46 mm
Attacco aria	1/2" GAS
Pressione di utilizzo	6,2 bar
Ø interno tubo aria	13 mm
Consumo aria medio	350 l/min
Peso	9,6 kg

1 kg 9,6 € 1.290,00 1 019300032



1930LA

avvitatore reversibile

• Meccanismo impulsivo doppio martello

1"
CE



Velocità libera	4.000 giri/min
Coppia massima	2.445 Nm
Capacità vite/dado	CI 8.8 M36●55 mm
Capacità vite/dado	CI 12.9 M30●46 mm
Attacco aria	1/2" GAS
Pressione di utilizzo	6,2 bar
Ø interno tubo aria	13 mm
Consumo aria medio	460 l/min
Peso	10,6 kg

1	kg	€	1	019300037
1	10,6	1.360,00		

1930HLA

avvitatore reversibile

• Meccanismo impulsivo doppio martello

1"
CE



Velocità libera	3.000 giri/min
Coppia massima	3.661 Nm
Capacità vite/dado	CI 8.8 M42●65 mm
Capacità vite/dado	CI 12.9 M33●50 mm
Attacco aria	1/2" GAS
Pressione di utilizzo	6,2 bar
Ø interno tubo aria	13 mm
Consumo aria medio	460 l/min
Peso	16,4 kg

1	kg	€	1	019300040
1	16,4	1.880,00		

1931CD6

trapano reversibile in composito

CE



Velocità libera	2.600 giri/min
Capacità mandrino	1÷6 mm
Potenza	0,23 kW
Filettatura albero	3/8" - 24UNF
Attacco aria	1/4" GAS
Pressione di utilizzo	6,2 bar
Ø interno tubo aria	8 mm
Consumo aria medio	130 l/min
Peso	0,6 kg

1	kg	€	1	019310006
0,6		276,00		

1930A

avvitatore reversibile

• Meccanismo impulsivo doppio martello

1"
CE



Velocità libera	4.000 giri/min
Coppia massima	2.445 Nm
Capacità vite/dado	CI 8.8 M36●55 mm
Capacità vite/dado	CI 12.9 M30●46 mm
Attacco aria	1/2" GAS
Pressione di utilizzo	6,2 bar
Ø interno tubo aria	13 mm
Consumo aria medio	460 l/min
Peso	9,5 kg

1	kg	€	1	019300036
1	9,5	1.310,00		

1930ZL

avvitatore reversibile

• Meccanismo impulsivo doppio martello

1 1/2"
CE



Velocità libera	3.000 giri/min
Coppia massima	4.068 Nm
Capacità vite/dado	CI 8.8 M42●65 mm
Capacità vite/dado	CI 12.9 M36●55 mm
Attacco aria	1/2" GAS
Pressione di utilizzo	6,2 bar
Ø interno tubo aria	13 mm
Consumo aria medio	480 l/min
Peso	15 kg

1	kg	€	1	019300070
1 1/2	15	2.365,00		

1931CD10

trapano reversibile in composito

CE



Velocità libera	1.800 giri/min
Capacità mandrino	1÷10 mm
Potenza	0,38 kW
Filettatura albero	3/8" - 24UNF
Attacco aria	1/4" GAS
Pressione di utilizzo	6,2 bar
Ø interno tubo aria	10 mm
Consumo aria medio	170 l/min
Peso	1,0 kg

1	kg	€	1	019310010
1,0		248,50		

1931CD13

trapano reversibile in composito



Velocità libera	800 giri/min
Capacità mandrino	1,0÷13 mm
Potenza	0,38 kW
Filettatura albero	1/2" - 20UNC
Attacco aria	1/4" GAS
Pressione di utilizzo	6,2 bar
Ø interno tubo aria	10 mm
Consumo aria medio	170 l/min
Peso	1,3 kg

kg 1,3 € 369,00 1 019310013

1932B10

trapano reversibile



Velocità libera	1.800 giri/min
Capacità mandrino	1÷10 mm
Potenza	0,44 kW
Filettatura albero	3/8" - 24UNF
Attacco aria	1/4" GAS
Pressione di utilizzo	6,2 bar
Ø interno tubo aria	10 mm
Consumo aria medio	160 l/min
Peso	1,2 kg

kg 1,2 € 197,50 1 019320040

1932B13

trapano reversibile



Velocità libera	400 giri/min
Capacità mandrino	1,5÷13 mm
Potenza	0,34 kW
Filettatura albero	1/2" - 20UNC
Attacco aria	1/4" GAS
Pressione di utilizzo	6,2 bar
Ø interno tubo aria	10 mm
Consumo aria medio	180 l/min
Peso	1,6 kg

kg 1,6 € 295,00 1 019320004

1931AN10

trapano angolare reversibile



Velocità libera	1.400 giri/min
Capacità mandrino	1÷10 mm
Potenza	0,38 kW
Filettatura albero	3/8" - 24UNF
Attacco aria	1/4" GAS
Pressione di utilizzo	6,2 bar
Ø interno tubo aria	10 mm
Consumo aria medio	150 l/min
Peso	1,1 kg

kg 1,1 € 276,00 1 019310030

1932RS13

trapano reversibile



Velocità libera	750 giri/min
Capacità mandrino	1,5÷13 mm
Potenza	0,55 kW
Filettatura albero	3/8" - 24UNF
Attacco aria	1/4" GAS
Pressione di utilizzo	6,2 bar
Ø interno tubo aria	10 mm
Consumo aria medio	160 l/min
Peso	1,4 kg

kg 1,4 € 251,00 1 019320043

1933IH

smerigliatrice assiale alta potenza

• Fornita con pinza di Ø 3 e 6 mm



Velocità libera	20.000 giri/min
Capacità pinza	3 - 6 mm
Potenza	0,75 kW
Attacco aria	1/4" GAS
Pressione di utilizzo	6,2 bar
Ø interno tubo aria	10 mm
Consumo aria medio	370 l/min
Peso	800 g

g 800 € 224,00 1 019330006

Beta
Quality Tools

19331LH

smerigliatrice assiale **alta potenza**
con albero prolungato

• Fornita con pinza di Ø 3 e 6 mm

CE



Velocità libera	20.000 giri/min
Capacità pinza	3 - 6 mm
Potenza	0,75 kW
Attacco aria	1/4" GAS
Pressione di utilizzo	6,2 bar
Ø interno tubo aria	10 mm
Consumo aria medio	370 l/min
Peso	1,2 kg

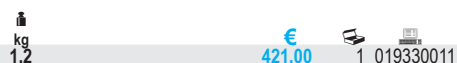

1933AN90-H

smerigliatrice angolare **alta potenza**

• Fornita con pinza di Ø 3 e 6 mm

CE



Velocità libera	15.000 giri/min
Capacità pinza	3 - 6 mm
Potenza	0,75 kW
Attacco aria	1/4" GAS
Pressione di utilizzo	6,2 bar
Ø interno tubo aria	10 mm
Consumo aria medio	370 l/min
Peso	1,1 kg

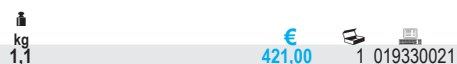

1933

smerigliatrice assiale

• Fornita con pinza di Ø 3 e 6 mm

CE



Velocità libera	25.000 giri/min
Capacità pinza	3 - 6 mm
Potenza	0,20 kW
Attacco aria	1/4" GAS
Pressione di utilizzo	6,2 bar
Ø interno tubo aria	10 mm
Consumo aria medio	230 l/min
Peso	380 g



1933I

smerigliatrice assiale

• Fornita con pinza di Ø 3 e 6 mm

CE



Velocità libera	20.000 giri/min
Capacità pinza	3 - 6 mm
Potenza	0,38 kW
Attacco aria	1/4" GAS
Pressione di utilizzo	6,2 bar
Ø interno tubo aria	10 mm
Consumo aria medio	260 l/min
Peso	670 g



1933L

smerigliatrice assiale
con albero prolungato

• Fornita con pinza di Ø 3 e 6 mm

CE



Velocità libera	25.000 giri/min
Capacità pinza	3 - 6 mm
Potenza	0,20 kW
Attacco aria	1/4" GAS
Pressione di utilizzo	6,2 bar
Ø interno tubo aria	10 mm
Consumo aria medio	270 l/min
Peso	670 g

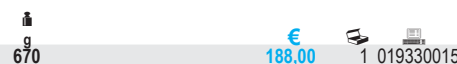

1933IL

smerigliatrice assiale con albero prolungato

• Fornita con pinza di Ø 3 e 6 mm

CE



Velocità libera	20.000 giri/min
Capacità pinza	3 - 6 mm
Potenza	0,38 kW
Attacco aria	1/4" GAS
Pressione di utilizzo	6,2 bar
Ø interno tubo aria	10 mm
Consumo aria medio	113 l/min
Peso	1,4 kg



1933AN90

smerigliatrice angolare

• Fornita con pinza di Ø 3 e 6 mm

CE



Velocità libera	20.000 giri/min
Capacità pinza	3 - 6 mm
Potenza	0,20 kW
Attacco aria	1/4" GAS
Pressione di utilizzo	6,2 bar
Ø interno tubo aria	10 mm
Consumo aria medio	230 l/min
Peso	510 g



1934BV

pulitrice a basse velocità

• Fornita con pinza di Ø 3 e 6 mm

CE



Velocità libera	3.700 giri/min
Capacità pinza	3 - 6 mm
Potenza	0,37 kW
Attacco aria	1/4" GAS
Pressione di utilizzo	6,2 bar
Ø interno tubo aria	10 mm
Consumo aria medio	113 l/min
Peso	840 g

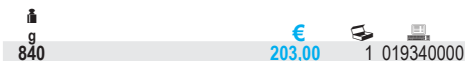

1934MAV

microsmerigliatrice assiale

CE



Velocità libera	56.000 giri/min
Capacità pinza	3 mm
Potenza	0,04 kW
Attacco aria	1/4" GAS BSPT
Pressione di utilizzo	6,2 bar
Ø interno tubo aria	4,5 mm
Consumo aria medio	115 l/min
Peso	205 g

g 205 € 174,00 1 019340010

1934MAV70

microsmerigliatrice assiale ad alta velocità

CE



Velocità libera	70.000 giri/min
Capacità pinza	3 mm
Potenza	0,08 kW
Attacco aria	1/4" GAS BSPT
Pressione di utilizzo	6,2 bar
Ø interno tubo aria	4,5 mm
Consumo aria medio	115 l/min
Peso	210 g

g 210 € 289,00 1 019340030

1935F

giravite reversibile

1/4

CE



Velocità libera	800 giri/min
Campo di coppia	4-16 Nm
Capacità vite	6-9 M
Porta inserti	1/4"
Attacco aria	1/4" GAS
Pressione di utilizzo	6,2 bar
Ø interno tubo aria	10 mm
Consumo aria medio	150 l/min
Peso	1,3 kg

kg 1,3 € 276,00 1 019350045

1936/4A

smerigliatrice angolare

CE



Velocità libera	11.000 giri/min
Dimensione mola	115 mm
Potenza	0,66 kW
Filettatura albero	M14
Attacco aria	1/4" GAS
Pressione di utilizzo	6,2 bar
Ø interno tubo aria	10 mm
Consumo aria medio	390 l/min
Peso	1,8 kg

kg 1,8 € 455,00 1 019360024

1936/5A

smerigliatrice angolare

CE



Velocità libera	10.000 giri/min
Dimensione mola	125 mm
Potenza	0,66 kW
Filettatura albero	M14
Attacco aria	1/4" GAS
Pressione di utilizzo	6,2 bar
Ø interno tubo aria	10 mm
Consumo aria medio	390 l/min
Peso	1,9 kg

kg 1,9 € 455,00 1 019360025

1936/7A

smerigliatrice angolare

CE



Velocità libera	7600 giri/min
Dimensione mola	180 mm
Potenza	1,3 kW
Filettatura albero	M14
Attacco aria	3/8" GAS
Pressione di utilizzo	6,2 bar
Ø interno tubo aria	13 mm
Consumo aria medio	906 l/min
Peso	2,7 kg

kg 2,7 € 666,00 1 019360027



1937

levigatrice rotorbitale palmare
senza lubrificazione, in composito

- Diametro orbita 5 mm
- Fornita completa di 3 adattatori per tubi:
Ø25,4mm (1") Ø28,6mm (1-1/8") Ø31,8mm (1-1/4")

CE



Ø 5 mm

Velocità libera	12.000 giri/min
Potenza	0,18 kW
Dimensione platorello	150 mm
Diametro orbita	5 mm
Filettatura albero	5/16"-24
Attacco aria	1/4" GAS
Pressione di utilizzo	6,2 bar
Ø interno tubo aria	10 mm
Consumo aria medio	170 l/min
Peso	0,86 kg

kg	€		
0,86	480,00	1	019370001

1937R/P

platorello Ø 150 mm 6 fori
per 1937



1937R/P	€		
	50,00	1	019370002

1937KC

mini levigatrice rotorbitale

- Diametro orbita 4 mm
- 2 platorelli di levigatura Ø 50 mm e Ø 75 mm
- 10 dischi carta abrasiva Ø 50 mm grana 400, 600, 800
- 10 dischi carta abrasiva Ø 75 mm grana 400, 600, 800

CE



Velocità libera	15000 giri/min
Potenza	0,25 kW
Dimensione platorello	50 - 75 mm
Filettatura albero	M6 x 1,0
Attacco aria	1/4" GAS BSPT
Pressione utilizzo	6,2 bar
Ø interno tubo aria	10 mm
Consumo aria medio	79 l/min
Peso lucidatrice	0,64 kg
Peso kit	1,4 kg

kg	€		
1,4	275,00	1	019370171

1937C...

dischi carta abrasiva per 1937KC



Ø mm	P	€		
50	400	16,40	1	019370175
50	600	16,40	1	019370176
50	800	16,40	1	019370177
75	400	20,80	1	019370178
75	600	20,80	1	019370179
75	800	20,80	1	019370180

* I prezzi indicati sono relativi a 10 pezzi

1937KL

mini lucidatrice

- Platorello di levigatura Ø 75 mm
- 2 spugne di lucidatura Ø 90mm - 1937/KL-DSB, 1937/KL-DSG
- Lana d'agnello Ø 90 mm - 1937/KL-DLA

CE



Velocità libera	3.200 giri/min
Potenza	0,25 kW
Dimensione platorello	75 mm
Filettatura albero	M6
Attacco aria	1/4" GAS BSPT
Pressione di utilizzo	6,2 bar
Ø interno tubo aria	10 mm
Consumo aria medio	91 l/min
Peso lucidatrice	0,75 kg
Peso kit	1,8 kg

kg	€		
1,8	299,00	1	019370161

1937KL-D

accessori per 1937KL



	Ø mm	€		
1937KL-DLA	90	27,00	1	019370164
1937KL-DSB	90	27,00	1	019370165
1937KL-DSG	90	27,00	1	019370166

1937K...

platorelli per 1937KC e 1937KL



	Ø mm	1937KC	1937KL	€		
1937KC-RP	50	•		29,50	1	019370173
1937KL-RP	75	•	•	35,50	1	019370163

1937M

levigatrice multifunzione
con 16 accessori

CE



Velocità libera	3.500 giri/min
Potenza	0,34 kW
Attacco aria	1/4" GAS
Pressione di utilizzo	6,2 bar
Ø interno tubo aria	10 mm
Consumo aria medio	113 l/min
Peso levigatrice	1,5 kg
Peso kit	4,5 kg

kg	€		
4,5	829,00	1	019370011

458x495x116 mm

1937M-01÷11

accessori per 1937M



	L mm	1937M-	€		
1937M-01	30		31,00	1	019370101
1937M-02	30		31,00	1	019370102
1937M-03	11		27,00	1	019370103
1937M-04	23		27,00	1	019370104
1937M-05	11		27,00	1	019370105
1937M-06	23		27,00	1	019370106
* 1937M-07	16		74,00	1	019370107
1937M-08	13	07	27,00	1	019370108
1937M-09	26	07	27,00	1	019370109
1937M-10	11	03, 05	27,00	1	019370110
1937M-11	23	01, 02, 04, 06	27,00	1	019370111

* I prezzi indicati sono relativi a 6 pezzi

1937N10

levigatrice a nastro



Velocità libera	20.000 giri/min
Potenza	0,37 kW
Dimensioni nastro	10x330 mm
Attacco aria	1/4" GAS
Pressione di utilizzo	6,2 bar
Ø interno tubo aria	10 mm
Consumo aria medio	374 l/min
Peso	0,9 kg

kg	€	1	019370041
0,9	323,00		

1937N10-GR

nastri abrasivi per 1937N10



	P	€	1	019370146
1937N10-GR60	60	34,00		
1937N10-GR80	80	34,00		
1937N10-GR100	100	34,00		
1937N10-GR120	120	34,00		

I prezzi indicati sono relativi a 10 pezzi

1937N20

levigatrice a nastro



Velocità libera	16.000 giri/min
Potenza	0,45 kW
Dimensioni nastro	20x520 mm
Attacco aria	1/4" GAS
Pressione di utilizzo	6,2 bar
Ø interno tubo aria	10 mm
Consumo aria medio	400 l/min
Peso	1,6 kg

kg	€	1	019370051
1,6	376,00		

1937N20-GR

nastri abrasivi per 1937N20



	P	€	1	019370156
1937N20-GR60	60	44,50		
1937N20-GR80	80	44,50		
1937N20-GR100	100	44,50		
1937N20-GR120	120	44,50		

I prezzi indicati sono relativi a 10 pezzi

1938

staccavetri

• Fornito con 1 lama dritta da 57 mm



Oscillazioni al minuto	20.000
Attacco aria	1/4" GAS
Pressione di utilizzo	6,2 bar
Ø interno tubo aria	6,5 mm
Consumo aria medio	200 l/min
Peso	1,0 kg

kg	€	1	019380021
1,0	253,00		

1938R/L

lame per staccavetri



	L mm	€	1	019380041
1938R/L1	57	21,50		
1938R/L2	90	39,50		
1938R/L3	30	24,00		
1938R/L4	8	34,00		
1938R/L5	36	39,00		

1938R/S5

serie di 5 lame per staccavetri 1938

kg	€	1	019380055
	158,00		

1940

martello scalpellatore

• Fornito con molla di ritegno e trattenitore di sicurezza a baionetta per punte esagonali



Colpi al minuto	3.500
Dimensione attacco	Ø 11 mm
Dimensione pistone	19 mm
Corsa del pistone	67 mm
Attacco aria	1/4" GAS
Pressione di utilizzo	6,2 bar
Ø interno tubo aria	8 mm
Consumo aria medio	240 l/min
Peso	1,9 kg

kg	€	1	019400001
1,9	203,00		

1940/C6

martello scalpellatore con 5 scalpelli e accessori

- Permette di tagliare lamiera, viti e carrozzerie, rimuovere punti di saldatura, rivetti, intonaci e piastrelle
- Assortimento in pratica valigetta in ABS composto da:
 - 1 martello scalpellatore 1940
 - 1 scalpello piatto 1940SN
 - 1 scalpello per demolizione 1940ST
 - 1 scalpello a punta tonda 1940SD
 - 1 scalpello inclinato ad unghia 1940SPS
 - 1 scalpello taglia lamiera 1940SDT
 - 1 molla di tenuta 1940MT
 - 1 trattenitore di sicurezza a baionetta per punte esagonali



Colpi al minuto	3.500
Dimensione attacco	Ø 11 mm
Dimensione pistone	19 mm
Corsa del pistone	67 mm
Attacco aria	1/4" GAS
Pressione di utilizzo	6,2 bar
Ø interno tubo aria	8 mm
Consumo aria medio	240 l/min

kg	€	1	019400000
3,3	288,00		
320x240x90 mm			

1940MT

molla di tenuta per 1940



1940MT	€ 13,30	5	019400110
--------	---------	---	-----------

1940S...

scalpelli per martelli scalpellatori 1940



1940SN	€ 16,30	5	019400020
1940ST	€ 16,30	5	019400021
1940SD	€ 16,30	5	019400022
1940SPS	€ 16,30	5	019400023
1940SDT	€ 16,30	5	019400024

1940/S5

serie di 5 scalpelli per martelli scalpellatori 1940



1940/S5	€ 74,00	1	019400030
---------	---------	---	-----------

1940E10

martello scalpellatore

- Compatibile con scalpelli con attacco esagonale da 10mm
- fornito con molla di ritegno e trattenitore di sicurezza a baionetta



Colpi al minuto	2.900
Dimensione attacco	○ 10 mm
Dimensione pistone	19 mm
Corsa del pistone	67 mm
Attacco aria	1/4" GAS
Pressione di utilizzo	6,2 bar
Ø interno tubo aria	10 mm
Consumo aria medio	76 l/min
Peso	1,7 kg

kg 1,7	€ 224,00	1	019400010
--------	----------	---	-----------

1940E10/MT

molla di tenuta per 1940E10



1940E10/MT	€ 1,76	5	019400112
------------	--------	---	-----------

1940E10/S...

scalpelli per martelli scalpellatori 1940E10



1940E10/SN	€ 11,30	5	019400040
1940E10/ST	€ 11,30	5	019400041
1940E10/SD	€ 11,30	5	019400042
1940E10/SPS	€ 11,30	5	019400043
1940E10/SDT	€ 11,30	5	019400044

1940E10/S5

serie di 5 scalpelli per martelli scalpellatori 1940E10



1940E10/S5	€ 56,50	1	019400050
------------	---------	---	-----------

1942A

seghetto alternativo

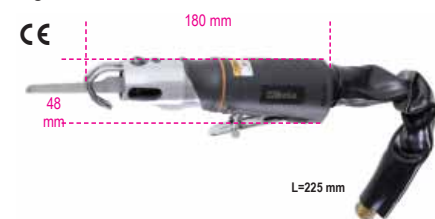

Corse al minuto	10.000
Lunghezza della corsa	10 mm
Attacco aria	1/4" GAS BSP
Pressione di utilizzo	6,2 bar
Ø interno tubo aria	8 mm
Consumo aria medio	75 l/min
Peso	550 g

kg 550	€ 338,00	1	019420000
--------	----------	---	-----------

1942LR

lame Bimetal per seghetto alternativo 1942A



1942LR	€ 7,85	5	019420032
--------	--------	---	-----------

1944A

scrostatore ad aghi assiale

CE



Colpi al minuto	3.800
Corsa del pistone	33 mm
N. aghi	19
Ø aghi	3 mm
Attacco aria	1/4" GAS
Pressione di utilizzo	6,2 bar
Ø interno tubo aria	10 mm
Consumo aria medio	85 l/min
Peso	2,8 kg

kg 2,8	€ 381,00	1	019440011
--------	----------	---	-----------

1944N

scrostatore ad aghi



Colpi al minuto	3800
Corsa del pistone	33 mm
N. aghi	19
Ø aghi	3 mm
Attacco aria	1/4" GAS
Pressione di utilizzo	6,2 bar
Ø interno tubo aria	10 mm
Consumo aria medio	85 l/min
Peso	2,7 kg

kg 2,7	€ 487,00	1	019440002
--------	----------	---	-----------

1944AR

aghi di ricambio per scrostatore 1944N e 1944A



1944AR 2	Ø mm 2	n. 29	€ 50,00	1	019440015
1944AR 3	Ø mm 3	n. 19	€ 39,00	1	019440005

1944PA

piastre porta aghi per 1944N e 1944A



	Ø mm	N.	€		
1944PA 2	2	29	55,00	1	019440016
1944PA 3	3	19	42,00	1	019440006

1945S

graffettrice

• Utilizza graffette tipo 80, sezione 0,95 x 0,65 mm (21 Gauge), lunghezza 4 - 16 mm, larghezza 12,8 mm



Capacità caricatore	157 pz.
Attacco aria	1/4" GAS
Pressione utilizzo	4,2 - 7 bar
Ø interno tubo aria	8 mm
Consumo aria (7 bar)	0,34 l/ciclo
Peso	0,87 kg

kg	€		
0,9	207,00	1	019450000

1945S/G...

graffette tipo 80, sezione 0,95x0,65 mm (21 Gauge), larghezza 12,8 mm per 1945S



	L mm	€		
• 1945S/G 4	4	19,30	1	019450004
1945S/G 6	6	7,60	1	019450006
1945S/G 8	8	8,20	1	019450008
1945S/G 10	10	9,20	1	019450010
1945S/G 12	12	10,30	1	019450012
1945S/G 14	14	11,10	1	019450014
1945S/G 16	16	12,20	1	019450016

I prezzi indicati sono relativi a 5.000 pezzi
• I prezzi indicati sono relativi a 10.000 pezzi

1945C

graffettrice, groppinatrice combinata

- Utilizza graffette tipo 90, sezione 1,25 x 1,0 mm (18 Gauge), lunghezza 16 - 40 mm, larghezza 5,8 mm
- Utilizza groppini tipo B12, sezione 1,25 x 1,0 mm (18 Gauge), lunghezza 15 - 50 mm, testa da 1,9 mm



Capacità caricatore	100 pz.
Attacco aria	1/4" GAS
Pressione utilizzo	5 - 8 bar
Ø interno tubo aria	8 mm
Consumo aria (7 bar)	1,12 l/ciclo
Peso	1,16 kg

kg	€		
1,16	273,00	1	019450200

1945C/G...

graffette tipo 90, sezione 1,25x1,0 mm (18 Gauge), larghezza 5,8 mm per 1945C



	L mm	€		
1945C/G 16	16	14,70	1	019450216
1945C/G 19	19	17,30	1	019450219
1945C/G 22	22	19,00	1	019450222
1945C/G 25	25	22,40	1	019450225
1945C/G 28	28	23,60	1	019450228
1945C/G 32	32	27,50	1	019450232
1945C/G 35	35	29,50	1	019450235
1945C/G 38	38	33,00	1	019450238
1945C/G 40	40	35,00	1	019450240

I prezzi indicati sono relativi a 5.000 pezzi

1945C/GP...

groppini tipo B12, sezione 1,25x1,0 mm (18 Gauge), testa da 1,9 mm per 1945C

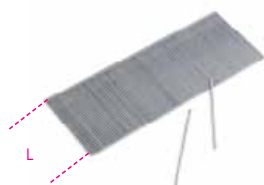

	L mm	€		
1945C/GP 15	15	7,70	1	019450255
1945C/GP 16	16	8,00	1	019450256
1945C/GP 20	20	9,20	1	019450260
1945C/GP 25	25	10,80	1	019450265
1945C/GP 30	30	12,60	1	019450270
1945C/GP 32	32	13,90	1	019450272
1945C/GP 35	35	14,90	1	019450275
1945C/GP 38	38	16,10	1	019450278
1945C/GP 40	40	16,60	1	019450280
1945C/GP 45	45	18,40	1	019450285
1945C/GP 50	50	20,20	1	019450290

I prezzi indicati sono relativi a 5.000 pezzi



1945P

spillatrice

• Utilizza spilli tipo B6, Ø 0,64 mm (23 Gauge), lunghezza 12 - 35 mm



Capacità caricatore	145 pz.
Attacco aria	1/4" GAS
Pressione utilizzo	4 - 7 bar
Ø interno tubo aria	8 mm
Consumo aria (7 bar)	0,27 l/ciclo
Peso	0,87 kg

kg	€		
0,87	331,00	1	019450100

1945P/S...

spilli tipo B6, Ø 0,64 mm (23 Gauge) per 1945P



	L mm	€		
1945P/S 12	12	9,00	1	019450112
1945P/S 15	15	9,85	1	019450115
1945P/S 18	18	10,70	1	019450118
1945P/S 20	20	12,40	1	019450120
1945P/S 21	21	12,60	1	019450121
1945P/S 22	22	13,00	1	019450122
1945P/S 25	25	13,90	1	019450125
1945P/S 30	30	15,90	1	019450130
1945P/S 35	35	18,10	1	019450135

I prezzi indicati sono relativi a 10.000 pezzi



1946 rivettatrice

• Fornita con ugelli intercambiabili da 2,4 - 3,2 - 4,0 - 4,8 mm



Potenza di trazione	8.000 N
Lunghezza della corsa	14 mm
Capacità massima rivetti	Ø alluminio 4,8 mm
Attacco aria	1/4" GAS
Pressione di utilizzo	6,2 bar
Ø interno tubo aria	6 mm
Consumo aria	1,2 l/ciclo
Peso	1,5 kg

kg 1,5 € 206,00 1 019460001

1946C4,8 rivettatrice

• Con aspirazione automatica
• Fornita assemblata per rivetti in acciaio, acciaio inox, alluminio e rame, da 2,4 - 3,2 - 4,0 - 4,8 mm



Potenza di trazione	8.900 N
Lunghezza della corsa	15 mm
Capacità massima rivetti	Ø acciaio inox 4,8 mm
Attacco aria	1/4" GAS
Pressione di utilizzo	6,2 bar
Ø interno tubo aria	10 mm
Consumo aria	2,6 l/ciclo
Peso	1,5 kg

kg 1,5 € 642,00 1 019460006

1946C7,8 rivettatrice

• Con aspirazione automatica
• Fornita assemblata per rivetti in acciaio, acciaio inox, alluminio e rame, da 4,8 - 5,6 - 6,4 - 7,8 mm



Potenza di trazione	16.900 N
Lunghezza della corsa	22,5 mm
Capacità massima rivetti	Ø acciaio inox 7,8 mm
Attacco aria	1/4" GAS
Pressione di utilizzo	6,2 bar
Ø interno tubo aria	10 mm
Consumo aria	4,9 l/ciclo
Peso	1,8 kg

kg 1,8 € 1.012,00 1 019460008

1946C/T... testine per rivetti strutturali



	Ø mm	€		
1946C/T4,8	4,8	39,00	1	019460016
1946C/T6,4	6,4	39,00	1	019460018

1946KF rivettatrice per inserti filettati

• Fornita assemblata per rivetti filettati in acciaio, acciaio inox, alluminio e rame, M4, M5, M6, M8



Potenza di trazione	14.235 N
Lunghezza della corsa	7 mm
Capacità massima rivetti	Ø acciaio inox M8
Attacco aria	1/4" GAS
Pressione di utilizzo	6,2 bar
Ø interno tubo aria	10 mm
Consumo aria	2,1 l/ciclo
Peso rivettatrice	2,1 kg
Peso kit	3,4 kg

kg 3,4 € 2.130,00 1 019460012

1946KF/M... perni di ricambio per 1946KF



	€		
1946KF/M4	71,50	1	019460124
1946KF/M5	71,50	1	019460125
1946KF/M6	71,50	1	019460126
1946KF/M8	68,50	1	019460128

1947 pistola per sigillanti

• Pistola pneumatica per silicone, collanti e sigillanti di media densità
• Supporta cartucce standard (215/218 x 50/51 mm) rigide



Dimensione del tubo	210x50 mm
Capacità della cartuccia	300 ml
Attacco aria	1/4" GAS
Pressione di utilizzo	4,8 bar
Ø interno tubo aria	10 mm
Consumo aria medio	120 l/min
Peso	1,1 kg

kg 1,1 € 72,00 1 019470001

1947H pistola per sigillanti

• Pistola pneumatica per l'estrusione di siliconi e sigillanti in cartucce standard di plastica o alluminio
• Supporta cartucce standard (215/218 x 50/51 mm) rigide
• Riduttore di pressione integrato



Dimensione del tubo	210x50 mm
Capacità della cartuccia	300/310 ml
Attacco aria	1/4" GAS
Pressione di utilizzo	4 + 8 bar
Ø interno tubo aria	2,5 mm
Consumo aria medio	120 l/min
Peso	750 g

g 750 € 251,00 1 019470011



1947G

pistola per ingrassaggio

testa pressofusa in alluminio
impugnatura ergonomica con figura a spigolo per accedere in spazi ristretti
valvola in ottone per un'elevata durata
funziona con cartucce da 400 g o grasso sfuso fino a 500 cc



dimensioni del tubo: 54 (interno) x 260 mm
attacco aria: 1/4" GAS
pressione d'utilizzo: 4÷10 bar
peso: 1.9 kg

1947G € 177,00 1 019470051

1947G2

pistola per ingrassaggio 2 in 1

per erogazione graduale o continua del grasso
testa pressofusa in alluminio
impugnatura ergonomica
funziona con cartucce da 400 g o grasso sfuso fino a 500 cc
completo di:
1 canna flessibile, lunghezza 800 mm
1 testina a 4 griffe tipo "Hydraulic" M10x1



Dimensione del tubo 54 (interno) x 276 mm
Attacco aria 1/4" GAS BSP
Pressione d'utilizzo 3÷10 bar
Peso 2,2 kg

1947G2 € 182,00 1 019470060

1948

penna per incisioni

• consente marcature su materiali quali l'acciaio, l'acciaio inossidabile, l'alluminio, il vetro, la pietra e la ceramica



Colpi al minuto 3.500 ÷ 3.800
Durezza massima 60 HRC
Attacco aria 1/4" GAS
Pressione di utilizzo 6,2 bar
Consumo aria medio 50 l/min
Peso 150 g

150 g € 332,00 1 019480001

1948PR

punta in carburo di tungsteno
di ricambio per 1948

• durezza massima: 60 HRC



1948PR € 125,50 1 019480005

1949XS

pistola di soffiaggio progressiva a penna

• In lega leggera
• Getto modulabile ruotando la testa



Filetto 1/4" GAS
Pressione di utilizzo 3-8 bar
Pressione massima di utilizzo 10 bar
Temperatura di utilizzo -20°C ÷ +70°C
Peso 20 g

20 g € 7,15 25 019490025

1949U5

pistola di soffiaggio progressiva con 5 ugelli

• Corpo in materiale composito ad alta resistenza, antiurto
• 3 ugelli in acciaio 100/160/320 mm con puntale di protezione in gomma antigraffio
• 1 ugello "Turbo" in nylon rinforzato con fibre di vetro con puntale di sicurezza
• 1 ugello orientabile 100 mm in nylon rinforzato con fibre di vetro
• Dotato di sistema di fissaggio rapido



Inserito ottone filettato 1/4" GAS
Pressione di utilizzo 10 bar
Pressione massima di utilizzo 15 bar
Consumo aria medio 280 l/min
Temperatura di utilizzo -10°C ÷ +85°C
Peso 93 g

93 g € 39,50 1 019490030

1949U5/A

ugello in acciaio 100 mm con puntale di protezione in gomma antigraffio per 1949U5 - 1949P



1949U5/A € 8,00 1 019490131

1949U5/B

ugello in acciaio 160 mm con puntale di protezione in gomma antigraffio per 1949U5 - 1949P



1949U5/B € 8,10 1 019490132

1949U5/C

ugello in acciaio 320 mm con puntale di protezione in gomma antigraffio per 1949U5 - 1949P



1949U5/C € 10,40 1 019490133

1949U5/D

ugello orientabile 100 mm in nylon rinforzato con fibre di vetro per 1949U5 - 1949P



1949U5/D € 7,60 1 019490134

Beta

1949U5/E

ugello "Turbo" in nylon rinforzato con fibre di vetro con puntale di sicurezza per 1949U5 - 1949P



1949U5/E € 3,75 1 019490135

1949U5/F

ugello a ventaglio piatto, in nylon rinforzato con fibre di vetro, per 1949U5 e 1949P



1949U5/F € 4,80 1 019490136

1949U5/G

ugello OSHA, in nylon rinforzato con fibre di vetro, per 1949U5 e 1949P



1949U5/G € 3,60 1 019490137

1949BC

pistola di soffiaggio progressiva con ugello in gomma

- Corpo in materiale composito ad alta resistenza, antiurto
- Ugello in gomma antigraffio sostituibile
- Dotato di innesto



Innesto alluminio filettato 1/4" GAS
 Pressione di utilizzo 6-8 bar
 Pressione massima di utilizzo 15 bar
 Consumo aria medio 87 l/min
 Temperatura di utilizzo -20°C ÷ 70°C
 Peso 120 g

120 g € 19,40 1 019490022

1949BC/RUL

5 ugelli lunghi con puntale in gomma per 1949BC



1949BC/RUL € 24,00 1 019490123

1949P

mini pistola di soffiaggio progressiva

- Corpo in materiale composito ad alta resistenza, antiurto
- Sistema di fissaggio rapido degli ugelli
- Flusso dell'aria regolabile tramite rotazione della ghiera



Innesto ottone filettato 1/4" GAS
 Pressione di utilizzo 6,2 bar
 Pressione massima di utilizzo 8,3 bar
 Consumo aria medio 280 l/min
 Temperatura di utilizzo -10°C ÷ 85°C
 Peso 70 g

70 g € 25,50 1 019490031

1949T

pistola di soffiaggio progressiva telescopica

- Corpo in materiale composito ad alta resistenza, antiurto
- Tubo telescopico in acciaio orientabile: 165 mm ÷ 300 mm
- Dotato di innesto

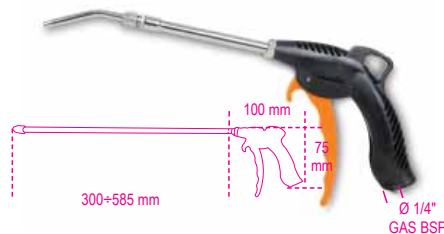

Innesto in alluminio filettato 1/4" GAS
 Pressione di utilizzo 6÷8 bar
 Pressione massima di utilizzo 15 bar
 Consumo aria medio 144 l/min
 Temperatura di utilizzo -20°C ÷ 70°C
 Peso 190 g

190 g € 31,00 1 019490040



1949F2

pistola di soffiaggio progressiva

- In composito di materiale plastico ad alta resistenza, antiurto, antigraffio e termicamente isolato
- La speciale valvola e la sensibilità della leva consentono la progressiva apertura del circuito, ottimizzando il flusso dell'aria
- Puntale dotato di cono di sicurezza in plastica per una movimentazione sicura in fase di non utilizzo



Innesto ottone filettato 1/4" GAS
 Pressione di utilizzo 4-8 bar
 Pressione massima di utilizzo 12 bar
 Temperatura di utilizzo -20°C ÷ 70°C
 Peso 125 g

125 g € 18,00 1 019490028

1949GPA

pistola per gonfiaggio pneumatici

- corpo interamente rivestito in gomma antiurto
- leva d'azionamento in metallo
- pressione di esercizio 0,5÷12 bar, 7÷174 psi
- funzione di scarico della pressione
- funzione di sola misurazione della pressione
- lunghezza tubo 58 cm
- rotazione del tubo a 360°
- attacco aria 1/4"



1949GPA bar psi € 115,00 1 019490018

1949DGT/2

pistola digitale per gonfiaggio pneumatici

- corpo interamente rivestito in gomma antiurto
- leva d'azionamento in metallo
- pressione di esercizio 0,5÷12 bar, 7÷174 psi
- 4 unità di misura, bar/psi/kpa/kgf
- display LCD retroilluminato
- risoluzione 0,05 bar
- spegnimento automatico dopo 1,5 minuti
- lunghezza tubo 58 cm
- rotazione del tubo a 360°
- alimentazione 2 batterie AAA
- attacco aria 1/4



CE

1949DGT/2 $\frac{\text{bar}}{0,5} = \frac{\text{psi}}{12}$ $\frac{\text{g}}{7} = \frac{\text{kgf}}{174}$ € 137,50 1 019490021

1949GPN

pistola per gonfiaggio pneumatici
corpo in ABS

- manometro certificato CE con scala 0,7÷12 bar (ripartizione in 1/10 bar)
- 2 pulsanti servoassistiti consentono il gonfiaggio (+) e lo sgonfiaggio (-) del pneumatico con precisione e rapidità
- fornita con certificato di taratura
- fornita con guscio di protezione antiurto e occhietto per aggancio
- fornita con raccordo filettato 1/4" GAS
- attacco aria girevole per tubo in gomma Ø7 mm

CE



1949GPN $\frac{\text{bar}}{0,7} = \frac{\text{g}}{12}$ $\frac{\text{g}}{810}$ € 238,50 1 019490011

1949M

misuratore di pressione per pneumatici



1949M $\frac{\text{bar}}{0} = \frac{\text{psi}}{4}$ $\frac{\text{g}}{5} = \frac{\text{kgf}}{60}$ $\frac{\text{g}}{280}$ € 80,50 1 019490400

1949R

pistola di soffiaggio
per pulizia radiatori
i 5 fori perpendicolari allo stelo
permettono la rimozione della
sporcizia dai radiatori



L mm 600 $\frac{\text{g}}{6}$ € 72,50 1 019490050

1950BZK

attrezzo tallonatore per pneumatici

Il tallonatore gomme Beta è dotato di maniglia secondaria con attivazione a pulsante per una presa a due mani più salda e sicura.

Caratteristiche

- Capacità serbatoio: 18 l
- Pressione d'esercizio: 3-8 bar
- Pressione massima serbatoio: 16 bar
- Valvola di sicurezza per sovrappressione
- Manometro con scala graduata
- Bocchettone in materiale plastico per non rovinare il cerchio

CE



1950BZK € 333,00 1 019500078



1951

pistola di lavaggio

- indicata per la pulizia di tappezzeria auto, moquette, sedili e bagagliai



Capacità serbatoio 1 L
Attacco aria 1/4" GAS
Pressione di utilizzo 6,2 bar
Ø interno tubo aria 8 mm
Consumo aria medio 110 l/min
Peso 650 g

g 650 € 156,00 1 019510051

1951A

pistola di lavaggio con aspirazione

- Indicata per la pulizia di tappezzeria auto, moquette, sedili e bagagliai
- Da utilizzare con detersivi specifici
- Serbatoio da 1L
- Dotato di rubinetto per la regolazione dell'uscita del liquido contenuto nel serbatoio
- Completa di tubo corrugato da 1,8 m
- Compatibile con aspiratore codice 1873-1874



Capacità serbatoio 1 l
Attacco aria 1/4" GAS
Pressione di utilizzo 6,2 bar
Ø interno tubo aria 8 mm
Consumo aria medio 120 l/min
Peso 800 g

g 800 € 253,00 1 019510101

1952

aerografo per verniciatura professionale

- Corpo in alluminio pressofuso con trattamento protettivo in nickel chimico nero
- Tazza in nylon con dispositivo salvagoccia, filetto 3/8M BSP
- Filettatura sul corpo 1/4" BSP Gas cilindrica
- Regolatore di pressione e di portata aria
- Regolatore del getto da tondo a ventaglio
- Regolatore della quantità di vernice
- Fornito con chiave di servizio per la manutenzione

CE



	Ø mm	€		
1952 1,2	1,2	167,00	1	019520012
1952 1,5	1,5	167,00	1	019520015
1952 1,8	1,8	167,00	1	019520018
1952 2,0	2,0	167,00	1	019520020

1900S

avvolgitubo automatico a molla
corpo in materiale plastico antiurto
per utilizzo con aria o acqua

- pressione di utilizzo massima 15 bar
- tubo in Poliuretano retinato
- struttura in Polipropilene
- dispositivo automatico di arresto del tubo alla lunghezza desiderata
- cremagliera disinseribile per tubo sempre in trazione
- temperatura di utilizzo -5°C/+50°C
- fornito con staffa orientabile di 180° e seconda staffa ad incastro rapido

CE



D1xD	L	Ø GAS	€		
mm	m	BSP			
1900S 8X10	8x12	1/4"	177,50	1	019000080

1900M

avvolgitubo automatico a molla
corpo in materiale plastico antiurto
per utilizzo con aria o acqua

- pressione di utilizzo massima 15 bar
- tubo in Poliuretano retinato
- struttura in Polipropilene
- dispositivo automatico di arresto del tubo alla lunghezza desiderata
- cremagliera disinseribile per tubo sempre in trazione
- temperatura di utilizzo -5°C/+50°C
- fornito con staffa orientabile di 180° e seconda staffa ad incastro rapido

CE

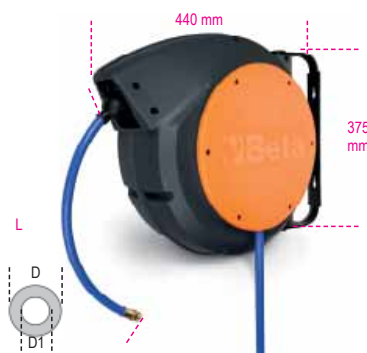

D1xD	L	Ø GAS	€		
mm	m	BSP			
1900M 8X15	8x12	1/4"	243,00	1	019000085
1900M 10X15	10x14	3/8"	253,00	1	019000115

1914

spirali in poliuretano 98 Shore estensibili

- Pressione di utilizzo massima 12 bar

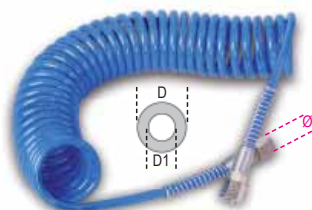

L	D1xD	Ø GAS	€		
m	mm	BSP			
4	5x8	1/4"	26,50	1	019140054
6	5x8	1/4"	31,00	1	019140056
10	5x8	1/4"	39,50	1	019140060

1915B

spirali in poliuretano 95 Shore
estensibili fino a 9 m

- Pressione di utilizzo massima 10 bar

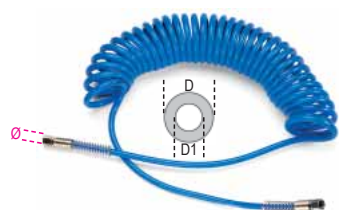

D1xD	Ø GAS	€		
mm	BSP			
6,5x10	1/4"	45,50	1	019150011
8x12	1/4"	54,50	1	019150012

1915C

spirali in poliuretano 95 Shore
estensibili fino a 12 m

- Pressione di utilizzo massima 10 bar



D1xD	Ø GAS	€		
mm	BSP			
6,5x10	1/4"	54,50	1	019150014
8x12	1/4"	67,00	1	019150015

1915C/L

spirali in poliuretano 95 Shore
estensibili fino a 15 m

- Pressione di utilizzo massima 10 bar

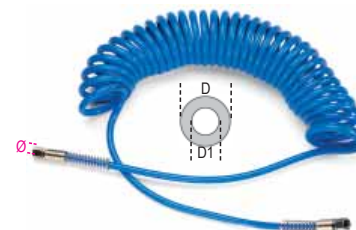

D1xD	Ø GAS	€		
mm	BSP			
8x12	1/4"	86,00	1	019150115
11x16	3/8"	145,50	1	019150116

1915D

tubo in poliuretano retinato 95 Shore
lunghezza 9 m

- Pressione di utilizzo massima 15 bar

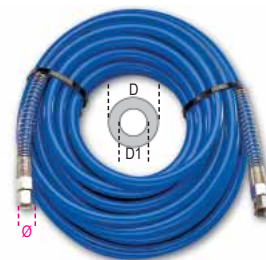

D1xD	Ø GAS	€		
mm	BSP			
8x12	1/4"	54,50	1	019150017

1915E

tubo in poliuretano retinato 95 Shore
lunghezza 12 m

- Pressione di utilizzo massima 15 bar



D1xD	Ø GAS	€		
mm	BSP			
8x12	1/4"	72,00	1	019150019
11x16	3/8"	107,50	1	019150020

1915E/XL

bobine in poliuretano retinato 95 Shore
lunghezza 50 m

• Pressione di utilizzo massima 15 bar



D1xD mm	Ø GAS BSP	€	🔧	📦
8x12	1/4"	247,50	1	019150519
11x16	3/8"	414,00	1	019150520

1916I

innesti rapidi profilo Italia
filettati maschio, GAS cilindrici BSP



Ø GAS BSP	€	🔧	📦
1/4"	3,15	5	019160001
3/8"	3,55	5	019160002

1916G

innesti rapidi profilo Europa
filettati maschio, GAS conici BSPT



Ø GAS BSPT	€	🔧	📦
1/4"	3,15	5	019160005
3/8"	4,15	5	019160010
1/2"	4,60	5	019160012

1916GF

innesti rapidi profilo Italia
filettati femmina, GAS cilindrici BSP



Ø GAS BSP	€	🔧	📦
1/4"	3,15	5	019160055
3/8"	3,55	5	019160060

1916GFE

innesti rapidi profilo Europa
filettati femmina, GAS conici BSPT



Ø GAS BSPT	€	🔧	📦
1/4"	3,15	5	019160075
3/8"	4,15	5	019160082
1/2"	4,60	5	019160084

1916JM

innesti rapidi profilo asiatico
filettati maschio, GAS conici BSPT



Ø GAS BSPT	€	🔧	📦
1/4"	4,40	1	019160406
3/8"	4,60	1	019160410

1916JF

innesti rapidi profilo asiatico
filettati femmina, GAS cilindrico BSP



Ø GAS BSP	€	🔧	📦
1/4"	4,40	1	019160456
3/8"	4,60	1	019160460

1916P

innesti rapidi profilo Italia
con mascherina portagomma



D1xD mm	€	🔧	📦
6x14	4,15	5	019160256
8x17	4,45	5	019160258
10x19	6,00	5	019160260

1916S

innesti rapidi profilo Italia
con molla a spirale

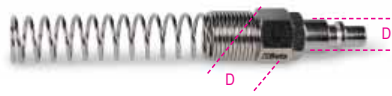

D1xD mm	€	🔧	📦
6x8	4,15	5	019160306
8x10	4,40	5	019160308
10x12	5,60	5	019160310

1917M

raccordi universali a sfera
con gomma antiurto
filettati maschio GAS cilindrici BSP

• accoppiabili agli innesti 1916I e 1916G



Ø GAS BSP	€	🔧	📦
1/4"	11,30	5	019170001
3/8"	11,30	5	019170003
1/2"	12,10	5	019170004

1917F

raccordi universali a sfera
con gomma antiurto
filettati femmina GAS cilindrici BSP

• accoppiabili agli innesti 1916I e 1916G



Ø GAS BSP	€	🔧	📦
1/4"	11,70	5	019170005
3/8"	11,30	5	019170010
1/2"	12,50	5	019170014

1917JM

raccordi universali a sfera
per profilo asiatico
filettati maschio GAS cilindrici BSP



Ø GAS BSP	€	🔧	📦
1/4"	18,80	1	019170406
3/8"	18,80	1	019170410
1/2"	20,20	1	019170412

1917JF

raccordi a sfera per profilo asiatico
filettati femmina GAS cilindrici BSP



Ø GAS BSP	€	🔧	📦
1/4"	18,80	1	019170456
3/8"	18,80	1	019170460

1917RG

raccordo universale rotante

- In alluminio, filetto femmina, GAS cilindrico BSP
- filetto maschio, cilindrico BSP
- Accoppiabile a tutti gli innesti con profilo Italia ed Europa
- Rotazione libera anche in assenza d'aria connessa



Ø GAS BSP	€	🔧	📦
1/4"	24,50	1	019170252

1917SP

raccordi universali a sfera
con mascherina portagomma



D1xD mm	€	5	019170206
6x14	12,10	5	019170206
8x17	12,60	5	019170208
10x19	14,40	5	019170210

1917ST

raccordi universali a sfera
con molla a spirale

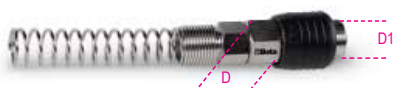

D1xD mm	€	5	019170306
6x8	11,30	5	019170306
8x10	11,40	5	019170308
10x12	12,90	5	019170310

1918

attacco a resca filettato maschio



D1 mm	Ø GAS BSP	€	3	019180106
6	1/8"	2,52	3	019180108
8	1/8"	2,52	3	019180116
6	1/4"	2,75	3	019180118
8	1/4"	2,90	3	019180120
10	1/4"	2,90	3	019180130
10	3/8"	3,30	3	019180132
12	3/8"	3,40	3	019180140
10	1/2"	4,50	3	019180142
12	1/2"	4,60	3	019180142

1918N

nippli di collegamento
con filetto conico BSPT



Ø GAS	Ø1 GAS	€	5	019180300
1/4"	1/4"	2,90	5	019180310
3/8"	3/8"	3,40	5	019180320
1/2"	1/2"	4,60	5	019180320



1918R

nippli di riduzione
con filetto conico BSPT



Ø GAS	Ø1 GAS	€	5	019180200
1/4"	3/8"	3,30	5	019180210
3/8"	1/2"	4,50	5	019180210

1919FE1/4

filtro regolatore lubrificatore



Attacchi aria entrata/uscita	1/4" GAS BSPT
Attacco manometro	1/8" GAS BSPT
Portata massima	750 l/min
Pressione massima	9,5 bar
Pressione di utilizzo	0,5 - 8,5 bar
Temperatura di utilizzo	5 - 60 °C
Capacità filtrante	5 micron
Capacità tazze	15 cc aria / 25 cc olio
Peso	700 g

g	€	1	019190200
700	113,50	1	019190200

1919RB-FE1/4

coppia bicchieri di ricambio
per 1919FE1/4



g	€	1	019190210
700	24,60	1	019190210

1919RF-FE1/4

ricambio elemento filtrante
per 1919FE1/4



g	€	1	019190230
700	6,70	1	019190230

1919RM-FE1/4

manometro di ricambio
per 1919FE1/4



g	€	1	019190220
700	14,50	1	019190220

1919F1/4

filtro regolatore lubrificatore



Attacchi aria entrata/uscita	1/4" GAS BSPT
Portata massima	1000 l/min
Pressione massima	9,5 bar
Pressione di utilizzo	0,5 - 8,5 bar
Temperatura di utilizzo	5 - 60 °C
Capacità filtrante	5 micron
Capacità tazze	60 cc aria / 90 cc olio
Peso	1,3 kg

kg	€	1	019190250
1,3	178,50	1	019190250



1919F3/8

filtro regolatore lubrificatore



Attacchi aria entrata/uscita 3/8" GAS BSPT
Portata massima 1350 l/min
Pressione massima 9,5 bar
Pressione di utilizzo 0,5 - 8,5 bar
Temperatura di utilizzo 5 - 60 °C
Capacità filtrante 5 micron
Capacità tazze 60 cc aria / 90 cc olio
Peso 1,3 kg

kg 1,3 € 178,50 1 019190350

1919F1/2

filtro regolatore lubrificatore



Attacchi aria entrata/uscita 1/2" GAS BSPT
Portata massima 2500 l/min
Pressione massima 9,5 bar
Pressione di utilizzo 0,5 - 8,5 bar
Temperatura di utilizzo 5 - 60 °C
Capacità filtrante 5 micron
Capacità tazze 60 cc aria / 90 cc olio
Peso 1,3 kg

kg 1,3 € 178,50 1 019190450

1919RB-F

coppia bicchieri
per filtri 1919F - 1/4", 3/8" e 1/2"



cc 500 € 31,50 1 019190510

1919RF-F

ricambio elemento filtrante
per filtri 1919F - 1/4", 3/8" e 1/2"



1919RF-F € 12,50 1 019190530

1919RM-F

manometro di ricambio
per filtri 1919F - 1/4", 3/8" e 1/2"



1919RM-F € 18,70 1 019190520

1919ML

mini lubrificatori di linea



Ø	L	Ø	€	1	019190030
1/4"	63	36	23,00	1	019190030
3/8"	63	36	25,00	1	019190032

1919SC

mini separatore di condensa



Ø	L	Ø	€	1	019190035
1/4"	80	40	29,50	1	019190035

1919L

olio lubrificatore ISO 32

Densità a 20°C 875 kg/m³
Viscosità a 40°C 32 cSt
Infiammabilità COC 210°C



cc 500 € 20,20 5 019190050

Beta

CONTENITORI E ASSORTIMENTI

VALIGIE E TROLLEY

BORSE E CESTELLI PORTAUTENSILI

TROLLEY PORTAUTENSILI

Applicazione	N° pezzi	VALIGIE E TROLLEY										BORSE E CESTELLI PORTAUTENSILI												TROLLEY PORTAUTENSILI																
		2009N/BV	2028/VV	2029/VV	2032/TV	2033L/VV	2036/TV	C99	C99V1	C99V3/2C	C4	C5	C5S	C6T	C9MT	C7	C8	C10	C9	C10S	C11	CP15L	C16	CP17	CP17L	C12	C14	CP15	C18	C19	C19L	C20	C20L	C41S	C41H	C42H				
5914VU/M	Interventi universali	109																									496													
5915VU/0	Interventi universali	35												498																										
5915VU/1	Interventi universali	45														498																								
5915VU/2	Interventi universali	49													499																									
5915VU/3	Interventi universali	74													499																									
5915VU/4	Interventi universali	80													499																									
5915VU/5	Interventi universali	111																									500													
5915VU/AS	Interventi universali	68																																						
5940SBK	Riparazione moto e bici	125																																						
5941VU/M	Interventi universali	64																																						
5980EL/A	Elettronica	57		514		514	514																																	
5980EL/B	Elettronica	98			515		515	515																																
5980ET/A	Elettrotecnica	70		512		512																						512												
5980ET/B	Elettrotecnica	64			513		513	513																				513												
5980ID/1	Idraulica	24	516											516																										
5980MQ	Elettrotecnica	46			513																																			
5980U/BIKE	Riparazione moto e bici	90																																						
5990V1	Interventi universali	44																																						
5990V3	Autoriparazione	116																																						

- **PRATICITÀ DI UTILIZZO**
- **ROBUSTEZZA**
- **DURATA NEL TEMPO**

BORSE E ZAINI IN TESSUTO TECNICO

Questi sono i tre cardini sui cui si sviluppa la gamma di Contenitori in Tessuto Beta. Le borse e gli zaini Beta sono realizzati in robusto tessuto tecnico, resistente alle abrasioni e all'usura, con fondo irrobustito e cuciture rinforzate per garantire un utilizzo affidabile nel tempo.

Ogni contenitore ha caratteristiche particolari pensate per utilizzi diversi e per l'ottimizzazione degli spazi: tasche con cerniera, impugnature a scomparsa, protezioni per le ruote, spillacci irrobustiti e buste trasparenti per documenti, sono solo alcune delle peculiarità proprie ad ogni borsa o zaino.

La costante cura dei dettagli, la varietà delle proposte e la particolare attenzione rivolta al trasporto degli utensili in totale sicurezza rendono questi prodotti i contenitori ideali in ogni condizione di lavoro.



VALIGIE IN POLIPROPILENE

Beta ti offre un'ampia gamma di valigie tecniche adatte ad ogni tipo di esigenza! Le valigie e i trolley Beta sono realizzati in robusto polipropilene ad alto spessore, resistente agli urti, alle sostanze corrosive e in grado di sopportare utilizzi gravosi anche a basse temperature.

Scegli il prodotto che più soddisfa la tua necessità lavorativa tra la classica valigia

portautensili, la versione trolley con ruote per un facile trasporto, le versioni con serrature TSA per viaggiare in totale libertà ed infine la versione in alluminio oppure a tenuta stagna impermeabile.

La maggior parte delle valigie e trolley Beta è disponibile anche in abbinamento ad assortimenti di utensili che rispondono a differenti esigenze lavorative, a seconda dei campi di applicazione: elettronica, idraulica, nautica e manutenzione.



2001/B26

busta in tessuto con assortimento di 26 utensili



2001/B26 € 247,00 1 020010215

- 55 6x7 - 8x9 - 10x11 - 12x13 - 14x15 - 16x17 mm
- 96N/SC9 1,5 - 2 - 2,5 - 3 - 4 - 5 - 6 - 8 - 10 mm
- 1128BMX 145 mm
- 1150 180 mm
- 1201E 3x75 - 4x100 - 5,5x150 mm
- 1202E PH1x80 - PH2x100 mm
- 1370 300 g
- 1692 2 m
- 1770A 9 mm

2001/BV € 56,50 1 020010051

2001/BZV

valigetta portautensili in tessuto tecnico ad alta resistenza, vuota

- Doppia maniglia superiore per una presa ottimale
- Ampia tasca frontale portadocumenti con chiusura a zip
- Fascia velcrata nella parte posteriore per fissare la valigetta alla maniglia dei trolley
- 20 pratici vani portautensili (6 tasche e 14 elastici)
- Asole porta martello
- Possibilità di applicazione della tracolla C9/RT (da ordinare a parte)



2001/BZV € 51,50 1 020010151

380x290x60 mm - 675 g



2001/BZ24 MQ

valigetta pieghevole con assortimento di 24 utensili per elettricisti



2001/BZ24 MQ € 355,00 1 020010154

	n.
1128BMX	1
1150MQ 180 mm	1
42 8-10-13-17-19 mm	5
1274MQ 3x100 - 4x100 - 5,5x125 mm	3
1272MQ PH0x60 - PH1x80 - PH2x100 mm	3
96BP/SC9 1,5-2-2,5-3-4-5-6-8-10 mm	9
1253	1
1082MQ 160 mm	1

2001/BZ27 VU

valigetta pieghevole con assortimento di 27 utensili per interventi universali



2001/BZ27 VU € 293,00 1 020010157

	n.
1128BMX	1
1150 180 mm	1
42 7-8-10-13-17-19 mm	6
1201E 3x75 - 4x100 - 5,5x150 mm	3
1202E PH0x60 - PH1x80 - PH2x100 mm	3
96/SC9 1,5-2-2,5-3-4-5-6-8-10 mm	9
1370 300 g	1
1048N 250 mm	1
1692/5 5 m	1
1771 18 mm	1

2002/BV6

busta portautensili di tipo avvolgibile in poliestere resistente, vuota

- Con 6 pratici scomparti portautensili di diversa dimensione
- Comoda da trasportare grazie alla maniglia centrale in tessuto rinforzato
- Dotata di pateletta interna per evitare la fuoriuscita degli utensili
- Cuciture di rinforzo presenti su tutto il perimetro della busta
- Doppia chiusura con velcro
- Dimensioni aperta: mm 175 x 240



2002/BV6 € 9,10 1 020020000

2002/BVL6

busta portautensili di tipo avvolgibile in poliestere resistente, vuota

- Con 6 pratici scomparti portautensili di diversa dimensione
- Comoda da trasportare grazie alla maniglia centrale in tessuto rinforzato
- Dotata di pateletta interna per evitare la fuoriuscita degli utensili
- Cuciture di rinforzo presenti su tutto il perimetro della busta
- Doppia chiusura con velcro
- Dimensioni aperta: mm 220 x 290



2002/BVL6 € 11,60 1 020020010

2002/BV7-ZIP

busta portautensili di tipo avvolgibile in poliestere resistente, vuota

- Con 7 pratici scomparti portautensili di diversa dimensione e taschina portaminuteria con chiusura a zip
- Comoda da trasportare grazie alla maniglia centrale in tessuto rinforzato
- Dotata di pateletta interna per evitare la fuoriuscita degli utensili
- Cuciture di rinforzo presenti su tutto il perimetro della busta
- Doppia chiusura con velcro
- Dimensioni aperta: mm 355 x 220



2002/BV7-ZIP € 20,80 1 020020060

2002/BV8

busta portautensili di tipo avvolgibile in poliestere resistente, vuota

- Con 8 pratici scomparti portautensili di diversa dimensione
- Comoda da trasportare grazie alla maniglia centrale in tessuto rinforzato
- Dotata di pateletta interna per evitare la fuoriuscita degli utensili
- Cuciture di rinforzo presenti su tutto il perimetro della busta
- Doppia chiusura con velcro
- Dimensioni aperta: mm 395 x 360



2002/BV8 € 11,60 1 020020020

2002/BV9

busta portautensili di tipo avvolgibile in poliestere resistente, vuota

- Con 9 pratici scomparti portautensili di diversa dimensione
- Comoda da trasportare grazie alla maniglia centrale in tessuto rinforzato
- Dotata di pateletta interna per evitare la fuoriuscita degli utensili
- Cuciture di rinforzo presenti su tutto il perimetro della busta
- Doppia chiusura con velcro
- Dimensioni aperta: mm 325 x 290



2002/BV9 € 11,60 1 020020030

2002/BV12

busta portautensili di tipo avvolgibile in poliestere resistente, vuota

- Con 12 pratici scomparti portautensili di diversa dimensione
- Comoda da trasportare grazie alla maniglia centrale in tessuto rinforzato
- Dotata di pateletta interna per evitare la fuoriuscita degli utensili
- Cuciture di rinforzo presenti su tutto il perimetro della busta
- Doppia chiusura con velcro
- Dimensioni aperta: mm 650 x 355



2002/BV12 € 19,30 1 020020040

2002/BV13

busta portautensili di tipo avvolgibile in poliestere resistente, vuota

- Con 13 pratici scomparti portautensili di diversa dimensione
- Comoda da trasportare grazie alla maniglia centrale in tessuto rinforzato
- Dotata di pateletta interna per evitare la fuoriuscita degli utensili
- Cuciture di rinforzo presenti su tutto il perimetro della busta
- Doppia chiusura con velcro
- Dimensioni aperta: mm 330 x 190



2002/BV13

€ 11,60

1 020020050

2002/BV42

busta portautensili di tipo avvolgibile in poliestere resistente, vuota

- Con 42 pratici scomparti portautensili di diversa dimensione:
 - 18 elastici e 24 tasche, di cui una dotata di pateletta di chiusura con velcro
- Comoda da trasportare grazie alla maniglia centrale in tessuto rinforzato
- Appendibile a muro per mezzo di anelli metallici
- Cuciture di rinforzo presenti su tutto il perimetro della busta
- Chiusura robusta con doppia fibbia a clip
- Dimensioni aperta: mm 595 x 540



2002/BV42

€ 28,50

1 020020070

2005MPU

marsupio porta attrezzi vuoto in Nylon, con cintura

- Cinque ampie tasche portautensili
- Una taschina frontale porta forbice
- Fibbia con moschettone porta nastro adesivo
- Cintura regolabile da 70 a 120 cm

Dimensioni: 155x285x80 mm



2005MPU

€ 30,00

1 020050060

2005MPU/E

marsupio porta attrezzi con assortimento di 5 utensili



2005MPU/E

€ 96,50

1 020050065

1128BMX

1150BM 180 mm

1201E 3,5x100 - 4x100 mm

1202E PH1x80 mm

155x285x80 mm

2005PA/D

porta attrezzi vuoto in Nylon, con cintura



2005PA/D

€ 70,50

1 020050000

2005PA/E

porta attrezzi vuoto in Nylon, con cintura

- Due ampie tasche con elastici portautensili
- Due taschine frontali porta forbice
- Due pratici scomparti laterali con:
 - a sinistra taschino con robusto gancio in metallo per flessometro
 - a destra doppia tasca con sacca richiudibile tramite laccio e chiusura a zip aggiuntiva
- Fibbia con moschettone porta nastro adesivo
- Cintura regolabile da 70 a 120 cm

Dimensioni: 260x250x190 mm



2005PA/E

€ 47,00

1 020050030

2005PA/ET

porta attrezzi con assortimento di 8 utensili per elettrotecnica



2005PA/ET

€ 191,50

1 020050035

1082MQ 160 160 mm

1128BMX

1253

1272MQF PH1x80 - PH2x100

1274MQF 3,5x100 - 4,5x100

1639ESB BMESB1925NE

260x250x190 mm

2005PA/S

porta attrezzi vuoto in Nylon, con cintura



2005PA/S

€ 35,50

1 020050020

2009N/BV

borsa per manutentori in cuoio



2009N/BV

€ 298,00

1 020090200

530x220x190 mm

2005PA/U

porta attrezzi con assortimento di 17 utensili per interventi universali



2005PA/U € 190,00 1 020050040

96/SC9

111E 200 mm

1048N 250 mm

1128BMX

1201E 4x100 - 5,5x125 mm

1202E PH1x80 - PH2x100 mm

1692/3 3 m

260x250x190 mm

2028/VV

valigia portautensili in polipropilene

- 2 pannelli portautensili
- Fondo interno con divisori removibili
- Doppia chiusura con combinazione



2028/VV € 246,50 1 020280010

480x190x400 mm

2028E

valigia con assortimento di utensili per elettronica ed elettrotecnica



2028EL/A € 1.215,00 1 020281014

(2028/VV+5980EL/A)

2028ET/A € 1.225,00 1 020281018

(2028/VV+5980ET/A)

2029/VV

valigia portautensili in polipropilene ad alto spessore, profilata in alluminio.

- 2 pannelli portautensili
- Fondo con divisori removibili e regolabili
- Fornita di tracolla
- 2 serrature con chiave



2029/VV € 353,00 1 020290000

480x227x408 mm

2029E

valigie con assortimenti di utensili per elettronica ed elettrotecnica



2029 BG MQ € 2.170,00 1 020291257

(2029/VV+5980MQ)

2029ET/B € 1.700,00 1 020291021

(2029/VV+5980ET/B)

2029EL/B € 1.715,00 1 020291017

(2029/VV+5980EL/B)

2029EM

valigia con assortimento di 43 utensili per manutenzione e riparazione veicoli ibridi ed elettrici



2029EM € 2.190,00 1 020290300

52MQ 7-8-9-10-11-12-13-14-15-16-17-19-22 mm

910MQ/B 6-7-10-12-13-17-19 mm

910MQ/TX TX25 - TX30 - TX40

910MQ/55

1048MQ 250 mm

1082MQ 160 mm

1128MQ 145 mm

1150MQ 180 mm

1162MQ 160 mm

1272MQ PH1 - PH2

1274MQ 2,5x75 - 3x100 - 4x100 - 5,5x125 - 6,5x150 mm

1760PT

1777MQ/U 190 mm

1996MQ/GM GM 10

7109A A1 - A2

7109D D2 - D3

2032/TV

trrolley portautensili in materiale plastico

- 2 pannelli portautensili
- Tasca portautensili interna
- Fondo interno con divisori removibili



2032/TV € 477,00 1 020320110

450x200x400 mm



2032/TE

trolley con assortimento di utensili per elettronica ed elettrotecnica



2032TET/A (2032/TV+5980ET/A) € 1.455,00 1 020321328

2033L/VV

valigia portautensili in alluminio, vuota

- Estremamente resistente agli urti
- Finitura antigraffio
- Maniglia ergonomica con grip in gomma
- Doppia chiusura con combinazione

- 2 pannelli portautensili con elastici
- Fondo interno con divisori removibili



2033L/VV € 386,00 1 020330250

470x203x373 mm

2033L

valigie in alluminio con assortimenti di utensili per elettronica ed elettrotecnica



2033LEL/A (2033L/VV+5980EL/A) € 1.355,00 1 020331224

2033LEL/B (2033L/VV+5980EL/B) € 1.750,00 1 020331225

2033LET/B (2033L/VV+5980ET/B) € 1.730,00 1 020331237

2036/TV

trolley portautensili in polipropilene ad alto spessore, profilato in alluminio

- 2 pannelli portautensili
- Manico telescopico
- Ruote con cuscinetti a sfera
- Fondo interno con divisori removibili



2036/TV € 559,00 1 020360000

480x267x408 mm

2036E

trolley con assortimenti di utensili per elettronica ed elettrotecnica



2036TET/B (2036/TV+5980ET/B) € 1.905,00 1 020361223

2036EL/B (2036/TV+5980EL/B) € 1.920,00 1 020361218

2037/TV

trolley portautensili in polipropilene ad alto spessore con 4 ruote pivotanti

Estremamente resistente agli urti. Indicato per il trasporto di utensili in aereo.

- 2 pannelli portautensili rimovibili.
- Tasca portadocumenti integrata.
- 4 ruote pivotanti rimovibili che consentono la movimentazione orizzontale del trolley.
- 2 vaschette portaminuteria incluse
- 2 serrature omologate TSA con chiave
- Maniglia ergonomica rivestita in gomma



2037/TV € 689,00 1 020370000

482x295x478 mm

2038/TV

trolley portautensili in polipropilene ad alto spessore

- Estremamente resistente agli urti.
- Profilo di tenuta in alluminio
- 2 serrature omologate TSA con chiave
- 2 pannelli portautensili rimovibili.
- Maniglione telescopico e grandi ruote con cuscinetti a sfera
- 2 maniglie (1 laterale) ergonomiche rivestite in gomma
- Fondo capiente
- Tasca porta documenti
- 3 cassettoni porta minuteria



2038/TV € 912,00 1 020380000

430x375x525 mm



2041UC

valigia Utility Case con assortimento di 33 utensili



2041UC € 363,00 1 020410215

- 55 6x7 - 8x9 - 10x11 - 12x13 - 14x15 - 16x17 mm
- 96/SC9 1,5 - 2 - 2,5 - 3 - 4 - 5 - 6 - 8 - 10 mm
- 111E 200 mm
- 1048VN 250 mm
- 1128BMX 145 mm
- 1150 180 mm
- 1201E 2,5x50 - 3x75 - 4x100 - 5,5x100 - 6,5x150 mm
- 1202E PH0x60 - PH1x80 - PH2x100 mm
- 1370 300 g
- 1692 3m
- 1771 170 mm
- 1833S 70 Lumen / 140 mm
- 1639NS-N 25m
- 1696 200 mm

≡ 535x282x87 mm - 4,5 Kg

2051N

valigia in polipropilene antiurto con assortimento di 55 utensili per nautica



2051N € 864,00 1 020510225

- 42 7 - 8 - 10 - 12 - 13 - 14 - 17 - 19 mm
- 55AS 3/8x7/16 - 1/2x9/16 - 5/8x11/16"
- 96/SC9 \varnothing 1,5+10 mm
- 111E 200 mm
- 920A \varnothing 10 - 12 - 13 - 14 - 17 - 19 mm
- 920AS \varnothing 7/16 - 1/2 - 9/16 - 11/16 - 7/8"
- 920/22 255 mm - \square 1/2 - \blacksquare 1/2
- 920/25 \square 1/2 - \blacksquare 1/2
- 920/42 \blacksquare 1/2
- 920/55 \blacksquare 1/2
- 956C \square 1/2 - 16 - 20,8 mm
- 1048BM 250 mm
- 1084BM 160 mm
- 1128BMX 145 mm
- 1150BM 180 mm
- 1166BM 160 mm
- 1201E \bullet 3x75 - 4x100 - 5,5x150 - 6,5x150 mm
- 1202E \oplus PH1x80 - PH2x100 mm
- 1390 \varnothing 35 mm
- 1490/2 \varnothing max 240 mm
- 1737 145 mm
- 1778X

BMN1436 3,6 x 140 mm

BMESB1925NE 25 m

≡ 585x393x92 mm - 9 kg

2055HB

valigia Home Bag con assortimento di 24 utensili



2055HB € 219,00 1 020550215

- 55 6x7 - 8x9 - 10x11 - 12x13 mm
- 96N/SC9 1,5 - 2 - 2,5 - 3 - 4 - 5 - 6 - 8 - 10 mm
- 1128BMX 145 mm
- 1150 180 mm
- 1048VN 250 mm
- 1201E 3x75 - 4x100 - 5,5x100 mm
- 1202E PH0x60 - PH1x80 - PH2x100 mm
- 1370 300 g
- 1692 3m

≡ 373x275x70 mm - 3 Kg

2080/V6

valigia organizer con 6 vaschette asportabili e divisori regolabili



2080/V6 mm € 40,50 1 020800060

2080/V6-U

vaschetta asportabile per valigia organizer 2080/V6



2080/V6-U € 3,10 1 020800066

≡ 90x60x50 mm

2080/D10

set 10 divisori regolabili per valigia organizer 2080/V6



2080/D10 € 8,20 1 020800070

2080/V12

valigia organizer con 12 vaschette asportabili



2080/V12 mm € 63,50 1 020800000

2080/V12-...

vaschetta asportabile per valigia organizer 2080/V12



2080/V12-S € 3,90 3 020800013

≡ 95x75x65 mm

2080/V12-M € 5,85 2 020800015

≡ 145x75x65 mm

2080/V12-L € 10,10 1 020800020

≡ 295x75x65 mm

C3

mini borsa portautensili in tessuto tecnico

Caratteristiche principali:

- 1 tasca esterna frontale con chiusura a zip
- 2 tasche laterali con vaschette portaminuteria incluse
- 1 pratica tasca posteriore con chiusura a velcro
- 1 pannello portautensili interno removibile, con elastici presenti su ambo i lati
- Interfaccia USB per la ricarica dei propri dispositivi mobili
- Fornita completa di tracolla



C3 € 68,00 1 021030000

230x110x320 mm - 890 g

C4 - 2104

secchiello portautensili in tessuto tecnico, vuoto

Pannello portautensili interno estraibile
Tasche ed elastici portautensili sia esterni che interni
Base rigida impermeabile con piedini in gomma
Fornito di tracolla



C4 € 115,00 1 021040000
2104VU/0 € 539,00 1 021041122

330x260x360 mm - 2,5 kg

C5S

zaino portautensili in poliestere resistente

- Doppia maniglia sulla sommità centrale dello zaino per una presa sicura e bilanciata
- Due ampie tasche frontali
- Due capienti tasche interne e 2 fasce aggiuntive con velcro
- Pratica busta avvolgibile interna, composta da 4 pannelli portautensili
- Spallacci imbottiti rinforzati e regolabili
- Carico massimo 15 Kg



C5S € 58,50 1 021050100

310x120x390 mm - 0,9 Kg

C5 - 2105

zaino portautensili in tessuto tecnico

- Pannello portautensili interno removibile
- Sei tasche esterne
- Due capienti tasche interne
- Base in materiale plastico resistente all'acqua
- Doppio laccetto di sicurezza per fissare lo zaino sulle spalle
- Schienale ergonomico imbottito



C5 € 164,00 1 021050000
2105VU/0 € 588,00 1 021051122

400x200x500 mm - 2,5 Kg

C6T - 2106

zaino portautensili in tessuto tecnico, con ruote

- Manico telescopico di trasporto
- Ruote integrate nella struttura con copertura anti-polvere per l'impiego come zaino
- Due pannelli portautensili removibili
- Cinque tasche esterne
- Capiente tasca per pc interna
- Base in materiale resistente all'acqua



C6T € 233,00 1 021060010
2106T/VU0 € 657,00 1 021061123

360x200x480 mm - 4,5 kg

C7 - 2107

borsa portautensili in tessuto tecnico

- 2 pannelli interni portautensili removibili
- 2 tasche esterne frontali
- Fondo interno in materiale plastico con divisori removibili



C7 € 242,50 1 021070000
2107VU/2 € 690,00 1 021071112

2107VU/3 € 1.187,00 1 021071114

480x165x380 mm - 3,5 kg

C7AT

borsa per assistenza tecnica in tessuto tecnico

Caratteristiche principali:

- Realizzata con tessuto tecnico ad altissima resistenza
- Base rinforzata con piedini in gomma
- Doppia maniglia superiore per una presa bilanciata e sicura
- Ampia tasca frontale portadocumenti con chiusura a zip e vano aggiuntivo con doppia chiusura velcro + clip
- Doppia tasca laterale con chiusura a velcro
- Capiente scompartimento interno con tasca portadocumenti aggiuntiva
- Vano porta PC e tablet con imbottitura interna di protezione (dimensioni PC fino a L=370 mm, H=250 mm)
- Apertura frontale con zip di entrambi i lati della borsa per un rapido accesso agli utensili:
 - 29 scomparti e 13 elastici portautensili sul lato anteriore;
 - 33 scomparti portautensili sul lato posteriore.
- Fornita completa di tracolla imbottita e regolabile



C7AT

€ 130,00



1 021070010

470x200x340 mm

C8 - 2108

trolley portautensili in tessuto tecnico

- Manico telescopico di trasporto
- 2 pannelli interni portautensili removibili
- Tasca porta PC interna
- 2 tasche esterne frontali
- Predisposizione per l'alloggiamento del cestello C10S



C8

€ 274,00



1 021080000

2108VU/1
(C8+5915VU/1)

€ 790,00



1 021081022

470x280x380 mm - 4 kg

C8B

trolley portautensili in tessuto tecnico per elettricisti

- Struttura rigida
- Manico telescopico di trasporto
- 4 ruote piroettanti
- 1 pannello interno portautensili removibile
- Tasca frontale con porta badge
- Doppio fondo con portaminuteria compreso
- 2 tasche esterne laterali
- 2 ganci porta sonda tirafili
- Manico inclinabile per facilitare l'accesso agli utensili
- Possibilità di chiusura con lucchetto (non compreso)



C8B

€ 221,00



1 021080300

380x250x430 mm - 4,7 kg

C9 - 2109

borsa portautensili in tessuto tecnico

- Base rigida
- Tasche interne ed esterne per l'inserimento di utensili
- Tasca esterna con chiusura a zip per maggior sicurezza
- Tasca chiudibile con strappo per oggetti personali
- Doppio fondo
- Doppio laccio per livelle
- Tracolla per facilitare il trasporto



C9

€ 132,50



1 021090000

2109VU/1
(C9+5915VU/1)

€ 649,00



1 021091022

2109VU/3
(C9+5915VU/3)

€ 1.077,00



1 021091024

550x280x320 mm - 2,6 kg

C9/RT

tracolla per C4,C7,C9,C10,C10S,C11, C12 e 2001/BZV



C9/RT

€ 17,20



1 021090900

C9DA

borsa portautensili ad apertura ampia

Caratteristiche principali:

- Realizzata con tessuto tecnico ad altissima resistenza
- Base rigida in materiale plastico resistente all'acqua
- Maniglia superiore rinforzata per una presa sicura
- Doppia tasca laterale con chiusura a velcro
- Due scomparti laterali portautensili ad apertura ampia, per un rapido accesso e perfetta visibilità del contenuto
 - 22 tasche portautensili e vano aggiuntivo con chiusura a zip sul lato anteriore
 - 14 tasche portautensili e vano aggiuntivo con chiusura a zip sul lato posteriore
- Fornita completa di tracolla imbottita e regolabile



C9DA

€ 105,00



1 021090005

420x220x310 mm

Beta

C9MT

borsa portautensili per manutentori

- Rivestimento esterno in robusto PVC, impermeabile
- Cuciture di rinforzo presenti su tutto il perimetro
- Chiusura con doppia fibbia a clip
- Doppia maniglia interna per una presa bilanciata e sicura
- Tasca portadocumenti con chiusura a zip



C9MT € 93,00 1 021090200

450x180x200 mm

2109MT ID/1

borsa per manutentori con assortimento di 24 utensili per idraulica



2109MT ID/1 € 668,00 1 021091026
(C9MT+5980ID/1)

- 111E 250 mm
- 332 Ø 3+28 mm
- 334 Ø 3+30 mm
- 342 Ø 0+42 mm
- 345SB2 140 mm
- 376 320-410 mm
- 1048N 175-250 mm
- 1128BMX
- 1150GBM 180 mm
- 1201E 3x75-4x100-5,5x150-8x150 mm
- 1202E PH1x80-PH2x100
- 1370 500 g
- 1690F 2 m
- 1692/5 5 m
- 1696 200 mm
- 1719BMA...M 200 mm
- 1719BM/RL 200 mm
- 1725

Beta

C9PT



C9PT 321

C10 - 2110

cestello portautensili in tessuto tecnico

Struttura rigida
Doppio fondo. Il fondo si può rimuovere per aumentare la capienza della borsa
Manico inclinabile per facilitare l'accesso agli utensili
Elastici portautensili e tasche sia interne che esterne
Fodero di copertura
Vaschetta portaminuterie incusa nel doppio fondo



C10 € 166,50 1 021100000
2110VU/1 € 683,00 1 021101031
(C10+5915VU/1)
2110VU/3 € 1.111,00 1 021101034
(C10+5915VU/3)
2110VU/AS € 1.205,00 1 021101036
(C10+5915VU/AS)

520x220x250 mm - 3,3 kg

C10S - 2110S

cestello portautensili in tessuto tecnico

Struttura rigida
Manico inclinabile per facilitare l'accesso agli utensili
Elastici portautensili e tasche sia interne che esterne
Fodero di copertura
Vaschetta portaminuterie incusa nel doppio fondo



C10S € 131,00 1 021100001
2110SVU/1 € 647,00 1 021101041
(C10S+5915VU/1)
2110SVU/3 € 1.075,00 1 021101044
(C10S+5915VU/3)

420x220x250 mm - 2,3 kg

C11 - 2111

cestello portautensili in tessuto tecnico

• Base rigida in materiale plastico resistente all'acqua
• Elastici e tasche portautensili sia interne che esterne
• Buste portadocumenti integrate nel doppiofondo del coperchio



C11 € 97,00 1 021110000
2111VU/1 € 613,00 1 021111031
(C11+5915VU/1)
2111VU/3 € 1.041,00 1 021111034
(C11+5915VU/3)

410x230x250 mm - 2 kg

Beta



C12 - 2112

borsa portautensili in tessuto tecnico

Pannello interno portautensili estraibile
Elastici portautensili e capienti tasche sia interne che esterne
La borsa si apre anteriormente per facilitare l'accesso agli utensili sul luogo di lavoro
Base rigida impermeabile con piedini in gomma



C12	€ 210,50	1	021120000
2112ET/A (C12+5980ET/A)	1.189,00	1	021121028
2112ET/B (C12+5980ET/B)	1.555,00	1	021121029
2112VU/5 (C12+5915VU/5)	1.415,00	1	021121056

≡ 500x270x350 mm - 5 kg

C13

baule portautensili con ruote,
in polipropilene ad alta resistenza

- Idoneo per uso esterno
- Resistente agli urti e agli agenti chimici
- Predisposizione per chiusura con lucchetto (non compreso)
- Dotato di due chiusure
- Due ruote che consentono la movimentazione orizzontale del baule
- Provvisto all'interno di una vaschetta porta minuteria rimovibile e bloccabile all'interno su due posizioni
- Targhetta identificativa portanome



C13	€ 348,00	1	021130000
-----	----------	---	-----------

≡ 806x350x467 mm - 7,2 kg

C14

trolley portautensili in polipropilene con 4 cassetti

- Struttura in polipropilene a iniezione che garantisce elevata resistenza agli urti.
- La parte anteriore, protetta dal coperchio frontale, ospita 4 cassetti 470x255 mm estraibili:
1 cassetto altezza 30 mm
2 cassetti altezza 60 mm
1 cassetto altezza 90 mm
- Serratura centralizzata frontale consente di chiudere contemporaneamente i due coperchi, quello superiore e quello frontale.
- Due maniglie laterali
- 4 robuste ruote posteriori
- Vassoio superiore removibile
- Pannello portautensili integrato nel coperchio
- 3 vaschette porta minuteria incluse
- Targhetta identificativa portanome
- Predisposizione per la chiusura con lucchetto TSA



C14	€ 888,00	1	021140000
2114VU/M (C14+5914VU/M)	2.030,00	1	021141011

≡ 585x390x457 mm - 10 kg

CP15 - 2115

cestello in materiale plastico con contenitore e vaschette portaminuterie asportabili

- 1 vaschetta portaminuterie integrata nel coperchio
- 2 vaschette portaminuterie asportabili con divisori regolabili
- 1 contenitore interno con divisori regolabili



CP15	€ 51,50	1	021150201
2115PVU/1 (CP15+5915VU/1)	568,00	1	021151232
2115PVU/2 (CP15+5915VU/2)	499,00	1	021151234

≡ 445x240x250 mm - 2 kg

CP15L - 2115

cestello modello lungo in materiale plastico con contenitore e vaschette portaminuterie

- 3 vaschette portaminuterie integrate nel coperchio con divisori regolabili
- 1 contenitore interno con divisori regolabili



CP15L	€ 70,00	1	021150202
2115PL-VU/1 (CP15L+5915VU/1)	586,00	1	021151242
2115PL-VU/3 (CP15L+5915VU/3)	1.014,00	1	021151245

558x277x270 mm - 2,5 kg

2115PI/BIKE-HOME

assortimento di 28 utensili per manutenzione
biciclette e E-Bike, in cestello in materiale
plastico

Riparazione biciclette



2115PI/BIKE-HOME	€ 282,00	1	021150098
------------------	----------	---	-----------

- 96BP/SC9
- 3935
- 3969K3
- 42 8-9-10-13-14 mm
- 42SLIM 15 mm
- 1082G 160 mm
- 1150G 180 mm
- 1201E 3x75 - 5,5x150 mm
- 1202E PH0x60 - PH2x100 mm
- 3991

- BMESB1925NE 25 mm
- BMN1436 3,6 x 140 mm

558x277x270 mm - 4,3 kg





2115P L-MQ32

assortimento di 32 utensili isolati per auto ibride, in cestello plastico con termoformato morbido



2115PL-MQ32 € 1.255,00 1 021150332

- 920MQ/55A
- 89MQ 10-12 mm
- 850MQ 1/4"
- 860TX/A10 T7-T8-T9-T10-T15-T20-T25-T27-T30-T40
- 920MQ/A 8-10-12-13-14-17-19 mm
- 920MQ/21 125mm
- 920MQ/22 250mm
- 1048MQ250 250mm
- 1150MQ 180mm
- 1164MQ160 160mm
- 1272MQ 4.5X80-6X100mm
- 1274MQ 3X100-4X100-5.5X125
- 1995MQ/G2 G2
- CP15L

C16 - 2116

cestello in materiale plastico con vano portaoggetti interno



C16 € 114,50 1 021160000
 2116VU/1 € 631,00 1 021161102 (C16+5915VU/1)
 2116VU/3 € 1.059,00 1 021161105 (C16+5915VU/3)

500x260x260 mm - 2,5 kg

CP17 - CP17L - 2117

cestello in acciaio inox e materiale plastico con contenitore asportabile



CP17
500x200x220 mm



CP17L
575x245x265 mm

CP17 € 96,00 1 021170500
 2117P-VU/1 € 612,00 1 021171042 (CP17+5915VU/1)
 2117P-VU/3 € 1.040,00 1 021171045 (CP17+5915VU/3)
 CP17L € 138,00 1 021170502
 2117L-VU/1 € 654,00 1 021171142 (CP17L+5915VU/1)
 2117PL-VU/3 € 1.082,00 1 021171145 (CP17L+5915VU/3)

C18 - 2118

cestello semplice in lamiera



C18 € 45,50 1 021180001
 2118VU/1 € 562,00 1 021181032 (C18+5915VU/1)
 450x200x100 mm - 3 kg

C19 - 2119 - C19L - 2119L

cestello estensibile a tre scomparti in lamiera



C19
450x200x160 mm



C19L
550x200x160 mm

C19 € 60,00 1 021190001
 2119VU/3 € 1.004,00 1 021191025 (C19+5915VU/3)
 C19L € 77,00 1 021190002
 2119L-VU/3 € 1.021,00 1 021191125 (C19L+5915VU/3)

C20 - C20L - 2120

cestello estensibile a cinque scomparti in lamiera



C20
450x200x210 mm



C20L
550x200x210 mm

C20 € 84,50 1 021200001
 2120VU/2 € 532,00 1 021201061 (C20+5915VU/2)
 2120VU/3 € 1.029,00 1 021201063 (C20+5915VU/3)
 2120VU/4 € 1.310,00 1 021201064 (C20+5915VU/4)
 2120VU/AS € 1.124,00 1 021201068 (C20+5915VU/AS)
 C20L € 92,50 1 021200002
 2120L-VU/2 € 540,00 1 021201161 (C20L+5915VU/2)
 2120L-VU/3 € 1.037,00 1 021201163 (C20L+5915VU/3)
 2120L-VU/4 € 1.320,00 1 021201164 (C20L+5915VU/4)
 2120L-VU/AS € 1.132,00 1 021201168 (C20L+5915VU/AS)



C20TSS

cestello estendibile a cinque scomparti
in acciaio inossidabile AISI 304



C20TSS € 310,00 1 021203001

≡: 450x200x210 mm - 4kg

C22B

baule portautensili in lamiera



C22B O
≡ 720x320x310 mm



C22BM O
≡ 850x360x350 mm



C22BL O
≡ 1010x410x400 mm

C22B-O € 240,00 1 022000150
C22BM-O € 276,00 1 022000160
C22BL-O € 368,00 1 022000170

C22B O: 13 kg
C22BM O: 20 kg
C22BL O: 26 kg

C22W

baule portautensili in lamiera, rivestito
internamente in legno per una maggiore
protezione degli utensili



C22W-O
≡ 690x300x360 mm



C22WL-O
≡ 990x300x360 mm

C22W-O € 267,00 1 022000269
C22WL-O € 347,00 1 022000299

C22W O: 15 kg
C22WL O: 28 kg

C22P

baule portautensili da cantiere, in lamiera

maniglie incassate a scomparsa
pattini rialzati per il sollevamento con muletto
doppia chiusura anti-effrazione per lucchetto (non incluso)



C22PM O
≡ 915x540x430 mm



C22PL O
≡ 1220x720x615 mm

C22PM-O € 715,00 1 022000240
C22PL-O € 1.104,00 1 022000245

C22PM O: 39 kg
C22PL O: 67 kg



Beta

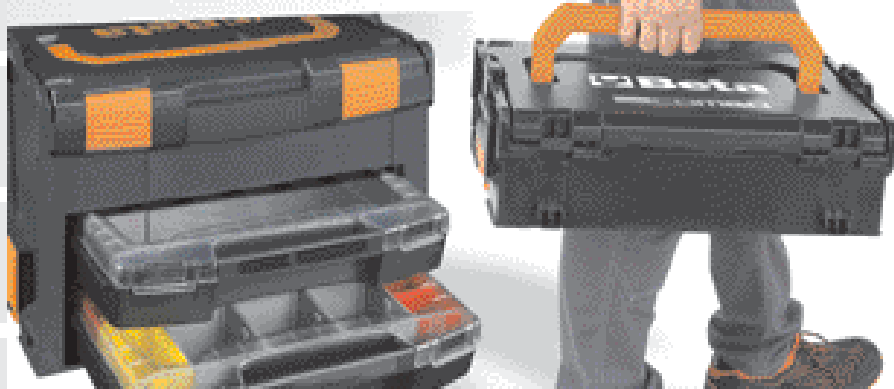

C99

Combo è il sistema modulare Beta

composto da **3 diverse tipologie di robuste valigette** portautensili per riporre in maniera ordinata e in totale sicurezza la vostra attrezzatura da lavoro.

Le valigette possono essere facilmente unite tra di loro con un **semplice click**, grazie alle pratiche chiusure laterali a scatto.

Il sistema Beta Combo C99 è compatibile con lo standard L-BOXX di Sortimo®

C99

sistema modulare completo COMBO

Le valigette porta attrezzi possono essere facilmente unite tra di loro con un semplice clic, grazie alle pratiche chiusure laterali a scatto.

Composto da:

- Carrello ultracompatto richiudibile con manico telescopico **C99P** (485x520x1095 mm)
- Valigetta portautensili in ABS **C99V1** (445x358x152 mm)
- Valigetta portautensili in ABS **C99V2** (445x358x254 mm)
- Valigetta portautensili in ABS con 2 cassette portaminuteria trasportabili **C99V3/2C** (445x358x322 mm)



C99

€ 702,00 1 099000010

C99V0

valigetta portautensili COMBO in ABS, con coperchio trasparente

Le valigette porta attrezzi possono essere facilmente unite tra di loro con un semplice clic, grazie alle pratiche chiusure laterali a scatto.

Caratteristiche principali:

- Coperchio trasparente in robusto policarbonato per una rapida individuazione del contenuto
- Dimensioni esterne 445x358x118 mm
- Capacità di carico max interna 25 Kg
- Predisposizione per la chiusura con lucchetto
- Peso 2,5 Kg

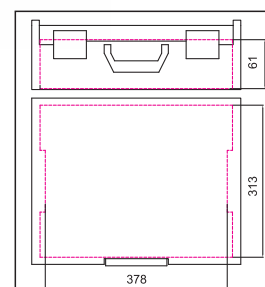

C99V0

€ 112,00 1 099000202

C99V0-P12

valigetta portautensili COMBO in ABS, con coperchio trasparente

Le valigette porta attrezzi possono essere facilmente unite tra di loro con un semplice clic, grazie alle pratiche chiusure laterali a scatto.

Caratteristiche principali:

- Coperchio trasparente in robusto policarbonato per una rapida individuazione del contenuto
- Particolarmente indicata per il trasporto di minuteria come viti, dadi, rondelle, rivetti o tasselli
- Fornita completa di kit 18 vaschette portaminuteria:
 - 2 vaschette rosse 52x52 mm
 - 3 vaschette gialle 104x52 mm
 - 2 vaschette blu 104x104 mm
 - 1 vaschetta verde 104x156 mm
 - 2 vaschette arancioni 208x52 mm
 - 2 vaschette grigie 312x71 mm e 6 divisori regolabili
- Dimensioni esterne 445x358x118 mm
- Capacità di carico max interna 25 Kg
- Predisposizione per la chiusura con lucchetto
- Peso 3,2 Kg

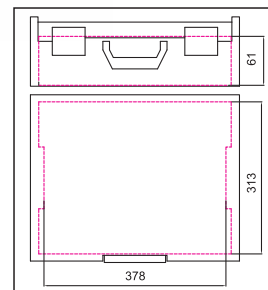

C99V0-P12

€ 159,50 1 099000200

C99P12-V0

kit 18 vaschette portaminuteria per valigette portautensili C99V0

Composizione:

- 2 vaschette rosse 52x52 mm
- 3 vaschette gialle 104x52 mm
- 2 vaschette blu 104x104 mm
- 1 vaschetta verde 104x156 mm
- 2 vaschette arancioni 208x52 mm
- 2 vaschette grigie 312x71 mm e 6 divisori regolabili



C99P12-V0

€ 49,50 1 099000499

C99V1

valigetta portautensili COMBO in ABS

Le valigette porta attrezzi possono essere facilmente unite tra di loro con un semplice clic, grazie alle pratiche chiusure laterali a scatto.

Caratteristiche principali:

- Dimensioni esterne 445x358x152 mm
- Capacità di carico max interna 25 Kg
- Predisposizione per la chiusura con lucchetto
- Peso 2,2 Kg

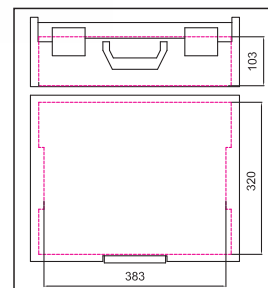

C99V1

€ 114,00 1 099000250

C99V2

valigetta portautensili COMBO in ABS

Le valigette porta attrezzi possono essere facilmente unite tra di loro con un semplice clic, grazie alle pratiche chiusure laterali a scatto.

Caratteristiche principali:

- Dimensioni esterne 445x358x254 mm
- Capacità di carico max. interna 25 Kg
- Peso 2,8 Kg

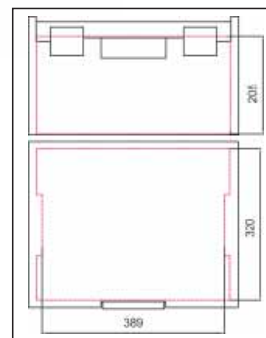

C99V2

€ 126,50 1 099000350

C99V3/2C

valigetta portautensili COMBO in ABS con 2 cassette portaminuteria trasportabili

Le valigette porta attrezzi possono essere facilmente unite tra di loro con un semplice clic, grazie alle pratiche chiusure laterali a scatto.

Caratteristiche principali:

- Dimensioni esterne 445x358x322 mm
- Capacità di carico max. interna 25 Kg
- Fornita con 2 cassette portaminuteria C99C-V3 vuote
- Peso 5,6 Kg

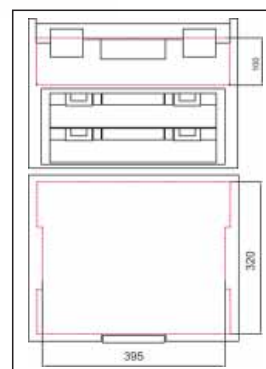

C99V3/2C

€ 243,00 1 099000450

C99C-V3

cassetta portautensili COMBO trasportabile

Coperchio trasparente per una rapida individuazione del contenuto

Maniglia integrata

Dimensioni esterne: 367x316x72 mm

Peso 0,9 Kg

Accessoriabile con:

- termoformato portaminuteria a 7 vani C99T-V3
- kit 17 vaschette portaminuteria C99P-V3

C99C-V3

€ 41,00



1



099000496

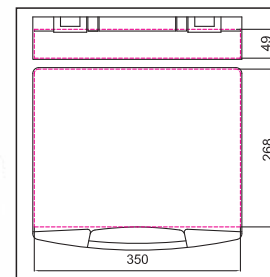

C99P

carrello pieghevole COMBO

Caratteristiche principali:

- Carrello ultracompatto richiudibile
- Impugnatura con manico telescopico
- Dimensioni aperto: 485x520x1095 mm
- Dimensioni chiuso: 485x80x810 mm
- Dimensioni base ribaltabile 485x350 mm
- Due ruote antiferatura Ø 175 mm
- Cinghia inclusa nella confezione
- Portata massima 100 kg.
- Peso 5,8 kg

C99P

€ 219,00



1



099000101



C99PC

rivestimento interno per coperchio valigette C99V1 e C99V3/2C

Indispensabile in abbinamento ai termoformati per evitare che il contenuto fuoriesca dai vani o si mischi durante il trasporto.

C99PC

400x320x20 mm

€ 19,30



1



099000491

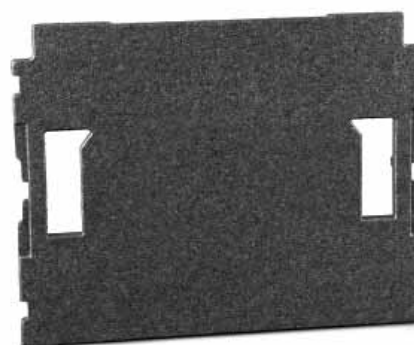

C99PP

pannello portautensili per valigette COMBO

- dotato di 6 tasche e 11 elastici portautensili
- fornito completo di ganci per il fissaggio del pannello all'interno del coperchio della valigetta

C99PP

€ 52,00



1



099000489



306 mm

376 mm



L'EVOLUZIONE DELLA PERFEZIONE

RSC22

cassettiera portatile con 3 cassetti

Caratteristiche principali:

- 3 cassetti da 588x277 mm, montati su guide telescopiche a sfera:
- 1 cassetto altezza 50 mm
- 2 cassetti altezza 70 mm.
- Serratura centralizzata frontale.
- Maniglie laterali a scomparsa per il trasporto.

19 kg



RSC22-O



RSC22-A



RSC22-R



h	max
50 mm	25 kg
70 mm	25 kg

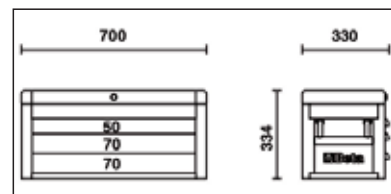
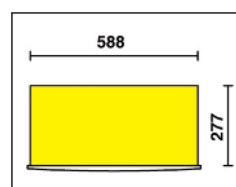

Model	RAL	Price (€)	Qty	Code
RSC22-O	RAL 2011	494,00	1	022003001
RSC22-R	RAL 3000	494,00	1	022003003
RSC22-A	RAL 7016	494,00	1	022003007

RSC23

cassettiera portatile
con 5 cassetti

Caratteristiche principali:

- 5 cassetti da 588x277 mm, montati su guide telescopiche a sfera:
- 2 cassetti altezza 50 mm
- 3 cassetti altezza 70 mm.
- Serratura centralizzata frontale.
- Maniglie laterali a scomparsa per il trasporto.

📦 26 kg



RSC23-A



RSC23-R



RSC23-O



h	max
50 mm	25 kg
70 mm	25 kg

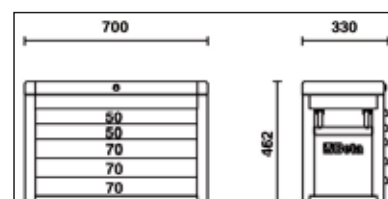
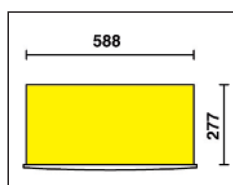

		€	📦	🏠
RSC23-O	RAL 2011	626,00	1	023003001
RSC23-R	RAL 3000	626,00	1	023003003
RSC23-A	RAL 7016	626,00	1	023003007

CD23S

carrello Caddy

Caratteristiche principali:

- Piano di lavoro ricoperto in ABS sul quale sono collocabili a misura le cassettiere RSC22, RSC23, RSC23C, RSC23T
- Timone di guida smontabile, collocabile sotto il piano.
- Quattro ruote Ø 100 mm: 2 fisse e 2 girevoli (una con freno).
- Portata massima 250 kg.

📦 14 kg



		€	📦	🏠
CD23S		288,00	1	023000610

RSC23C

cassettiera portatile
con 8 cassetti

Caratteristiche principali:

- 8 cassetti da 588x277 mm, montati su guide telescopiche a sfera:
- 4 cassetti altezza 50 mm
- 3 cassetti altezza 70 mm
- 1 cassetto altezza 100 mm.
- Serratura centralizzata frontale.
- Maniglie laterali a scomparsa per il trasporto.

📦 28 kg



RSC23C-A



RSC23C-R



RSC23C-O



h	max
50 mm	25 kg
70 mm	25 kg

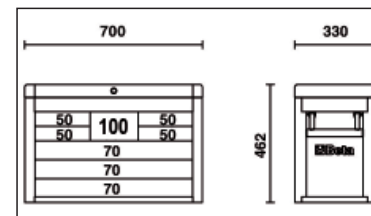
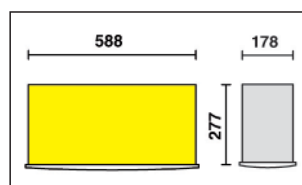

		€	📦	🏠
RSC23C-O	RAL 2011	707,00	1	023003011
RSC23C-R	RAL 3000	707,00	1	023003013
RSC23C-A	RAL 7016	707,00	1	023003017

RSC23T

cassettiera portatile
con 5 cassetti

Caratteristiche principali:

- 5 cassetti da 588x367 mm, montati su guide telescopiche a sfera:
- 5 cassetti altezza 70 mm
- Serratura centralizzata frontale.
- Possibilità di applicazione del kit 4 ruote più maniglione (2300ST/KIT)

📦 36 kg



RSC23T-A



RSC23T-B



RSC23T-G



RSC23T-N



RSC23T-R



RSC23T-O



RSC23T-FO

h	max
70 mm	25 kg

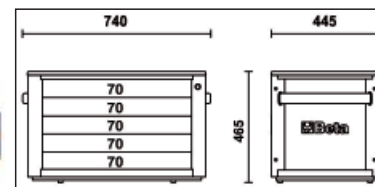

		€	📦	🖨️
RSC23T-FO	RAL 2011	789,00	1	023003020
RSC23T-O	RAL 2011	789,00	1	023003021
RSC23T-G	RAL 9006	789,00	1	023003022
RSC23T-R	RAL 3000	789,00	1	023003023
RSC23T-B	RAL 5015	789,00	1	023003026
RSC23T-A	RAL 7016	789,00	1	023003027
RSC23T-N	RAL 9005	789,00	1	023003029

2300ST/KIT

kit con quattro ruote e maniglione per RSC23T

- Quattro ruote Ø 125 mm:
- 2 fisse e 2 girevoli (una con freno).
- Maniglione telescopico

📦 6,5 kg

	€	📦	🖨️
2300ST/KIT	212,50	1	023000950



Beta

CASSETTIERA MOBILE RSC24

Beta
RSC24



PIANO DI LAVORO

- + **SOLIDO E ROBUSTO**
- + **PRATICO E FUNZIONALE**
- + **MODERNO**



- Cassetti montati su guide telescopiche a sfera
- Piano dei cassetti protetto da tappetini di gomma espansa
- Possibilità di inserire in ogni cassetto fino a 4 vassoi morbidi in EVA o termoformati rigidi in ABS
- Nuovo piano di lavoro rinforzato in ABS, sul quale è collocabile a misura una cassetteria portatile RSC22, RSC23, RSC23C e RSC23T
- Piano di appoggio multifunzione con bordi anticaduta e otto fori per l'alloggiamento dei giravite
- Serratura di sicurezza centralizzata frontale
- Quattro ruote Ø 125 mm: 2 fisse e 2 girevoli (una con freno)
- Capacità di carico statico: 800 kg
- Porta flaconi laterale integrato, applicabile su entrambi i lati

Modelli disponibili:

- RSC24/5 (5 cassetti)
- RSC24/6 (6 cassetti)
- RSC24/7 (7 cassetti)
- RSC24/8 (8 cassetti)

Colori disponibili:

RSC24-		
FO	RAL 2011	RAL 2011
O	RAL 7016	RAL 2011
G	RAL 7016	RAL 9006
R	RAL 7016	RAL 3000
B	RAL 7016	RAL 5015
A	RAL 7016	RAL 7016
N	RAL 9005	RAL 9005

Accessori disponibili:

2400 RSC24/PF



2400 RSC24/SPC

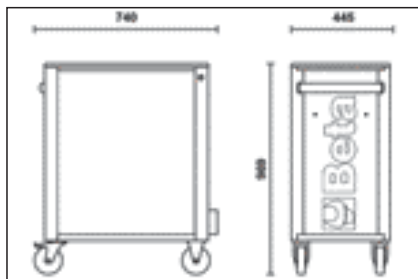
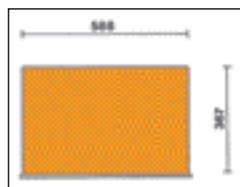

RSC24/7

cassetteria mobile con 7 cassetti

Caratteristiche principali:

- 7 cassetti da 588x367 mm ad estrazione totale, montati su guide telescopiche a sfera:
- 5 cassetti altezza 70 mm
- 1 cassetto altezza 140 mm
- 1 cassetto altezza 210 mm

63 kg

	€	1	024004070
RSC24/7-FO	1.099,00	1	024004070
RSC24/7-O	1.099,00	1	024004071
RSC24/7-G	1.099,00	1	024004072
RSC24/7-R	1.099,00	1	024004073
RSC24/7-B	1.099,00	1	024004076
RSC24/7-A	1.099,00	1	024004077
RSC24/7-N	1.099,00	1	024004079



RSC24/7-O

Beta
RSC24



h	max
70 mm	25 kg
140 mm	30 kg
210 mm	30 kg

RSC24/5

cassettiera mobile con 5 cassetti

Caratteristiche principali:

- 5 cassetti da 588x367 mm ad estrazione totale, montati su guide telescopiche a sfera:
- 2 cassetti altezza 70 mm
- 2 cassetti altezza 140 mm
- 1 cassetto altezza 280 mm

60 kg

	€		
RSC24/5-FO	949,00	1	024004050
RSC24/5-O	949,00	1	024004051
RSC24/5-G	949,00	1	024004052
RSC24/5-R	949,00	1	024004053
RSC24/5-B	949,00	1	024004056
RSC24/5-A	949,00	1	024004057
RSC24/5-N	949,00	1	024004059



RSC24/5-O

Beta RSC24



h	max
70 mm	25 kg
140 mm	30 kg
280 mm	35 kg

RSC24/6

cassettiera mobile con 6 cassetti

Caratteristiche principali:

- 6 cassetti da 588x367 mm ad estrazione totale, montati su guide telescopiche a sfera:
- 4 cassetti altezza 70 mm
- 1 cassetto altezza 140 mm
- 1 cassetto altezza 280 mm

62 kg

	€		
RSC24/6-FO	1.022,00	1	024004060
RSC24/6-O	1.022,00	1	024004061
RSC24/6-G	1.022,00	1	024004062
RSC24/6-R	1.022,00	1	024004063
RSC24/6-B	1.022,00	1	024004066
RSC24/6-A	1.022,00	1	024004067
RSC24/6-N	1.022,00	1	024004069



RSC24/6-O

Beta RSC24



h	max
70 mm	25 kg
140 mm	30 kg
280 mm	35 kg

RSC24/8

cassettiera mobile con 8 cassetti

Caratteristiche principali:

- 8 cassetti da 588x367 mm ad estrazione totale, montati su guide telescopiche a sfera:
- 6 cassetti altezza 70 mm
- 2 cassetti altezza 140 mm

66 kg

	€		
RSC24/8-FO	1.187,00	1	024004080
RSC24/8-O	1.187,00	1	024004081
RSC24/8-G	1.187,00	1	024004082
RSC24/8-R	1.187,00	1	024004083
RSC24/8-B	1.187,00	1	024004086
RSC24/8-A	1.187,00	1	024004087
RSC24/8-N	1.187,00	1	024004089



RSC24/8-O

Beta RSC24



h	max
70 mm	25 kg
140 mm	30 kg

RSC24A/6

cassettiera mobile con 6 cassetti,
con sistema antiribaltamento

Caratteristiche principali:

- 6 cassetti da 588x367 mm ad estrazione totale, montati su guide telescopiche a sfera:
- 4 cassetti altezza 70 mm
- 1 cassetto altezza 140 mm
- 1 cassetto altezza 280 mm

62 kg

	€		
RSC24A/6-O	1.137,00	1	024004161
RSC24A/6-R	1.137,00	1	024004163
RSC24A/6-A	1.137,00	1	024004167



RSC24A/6-O

Beta RSC24



RSC24A/6-A



RSC24A/6-R



h	max
70 mm	25 kg
140 mm	30 kg
280 mm	35 kg

RSC24A/7

cassettiera mobile con 7 cassetti,
con sistema antiribaltamento

Caratteristiche principali:

- 7 cassetti da 588x367 mm ad estrazione totale, montati su guide telescopiche a sfera:
- 5 cassetti altezza 70 mm
- 1 cassetto altezza 140 mm
- 1 cassetto altezza 210 mm

63 kg

	€		
RSC24A/7-O	1.215,00	1	024004171
RSC24A/7-R	1.215,00	1	024004173
RSC24A/7-A	1.215,00	1	024004177



RSC24A/7-O

Beta RSC24



RSC24A/7-A



RSC24A/7-R



h	max
70 mm	25 kg
140 mm	30 kg
210 mm	30 kg

RSC24A/8

cassettiera mobile con 8 cassetti,
con sistema antiribaltamento

Caratteristiche principali:

- 8 cassetti da 588x367 mm ad estrazione totale, montati su guide telescopiche a sfera:
- 6 cassetti altezza 70 mm
- 2 cassetti altezza 140 mm

66 kg

	€		
RSC24A/8-O	1.315,00	1	024004181
RSC24A/8-R	1.315,00	1	024004183
RSC24A/8-A	1.315,00	1	024004187



RSC24A/8-O

Beta RSC24



RSC24A/8-A



RSC24A/8-R



h	max
70 mm	25 kg
140 mm	30 kg



VERSIONE LUNGA:
può contenere fino a 6 vassoi morbidi in EVA
o termoformati rigidi in ABS per cassetto

SISTEMA ANTIRIBALTAMENTO:
NON CONSENTE L'APERTURA
CONTEMPORANEA DI PIÙ CASSETTI



- Cassetti montati su guide telescopiche a sfera
- Nuovo piano di lavoro rinforzato in ABS con bordi anticaduta, otto fori per l'alloggiamento dei giravite e 6 vaschette portaminuterie.
- Frontalino in nylon ad alta resistenza con porta-etichette integrato
- Quattro ruote Ø 125 mm: 2 fisse e 2 girevoli (una con freno)
- Capacità di carico statico: 1.000 kg
- Piano dei cassetti protetto da tappetini di gomma espansa
- Portaflaconi laterale integrato
- Serratura di sicurezza centralizzata frontale

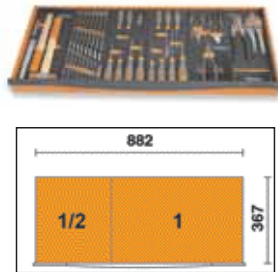
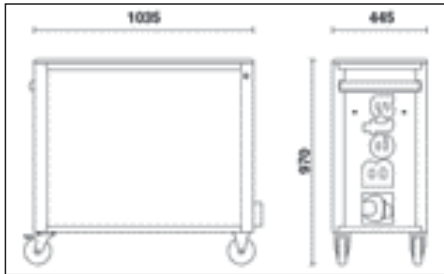

Colori disponibili:

O	RAL 7016	RAL 2011
R	RAL 7016	RAL 3000
A	RAL 7016	RAL 7016

Accessori disponibili:



RSC24AXL/7

cassettiera mobile con 7 cassetti,
con sistema antiribaltamento,
modello lungo

Caratteristiche principali:

- 7 cassetti da 882x367 mm ad estrazione totale, montati su guide telescopiche a sfera:
- 5 cassetti altezza 70 mm
- 1 cassetto altezza 140 mm
- 1 cassetto altezza 210 mm

84 kg



Beta RSC24



RSC24AXL/7-A



RSC24AXL/7-R

h	max
70 mm	30 kg
140 mm	35 kg
210 mm	35 kg

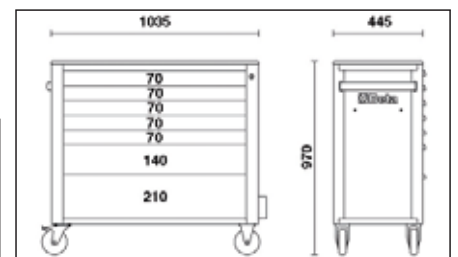
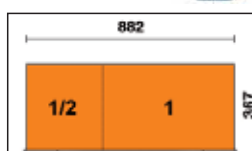

RSC24AXL/7-O	1.545,00 €	1	024004271
RSC24AXL/7-R	1.545,00 €	1	024004273
RSC24AXL/7-A	1.545,00 €	1	024004277

RSC24AXL/8

cassettiera mobile con 8 cassetti,
con sistema antiribaltamento,
modello lungo

Caratteristiche principali:

- 8 cassetti da 882x367 mm ad estrazione totale, montati su guide telescopiche a sfera:
- 6 cassetti altezza 70 mm
- 2 cassetto altezza 140 mm

88 kg

	€		
RSC24AXL/8-O	1.655,00	1	024004281
RSC24AXL/8-R	1.655,00	1	024004283
RSC24AXL/8-A	1.655,00	1	024004287



h	max
70 mm	30 kg
140 mm	35 kg

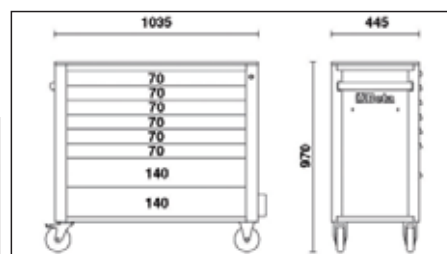
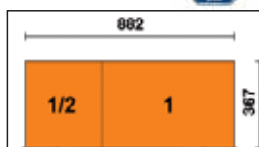

RSC24AXL/9

cassettiera mobile con 9 cassetti,
con sistema antiribaltamento,
modello lungo

Caratteristiche principali:

- 9 cassetti da 882x367 mm ad estrazione totale, montati su guide telescopiche a sfera:
- 8 cassetti altezza 70 mm
- 1 cassetto altezza 140 mm

90 kg

	€		
RSC24AXL/9-O	1.760,00	1	024004291
RSC24AXL/9-R	1.760,00	1	024004293
RSC24AXL/9-A	1.760,00	1	024004297



h	max
70 mm	30 kg
140 mm	35 kg

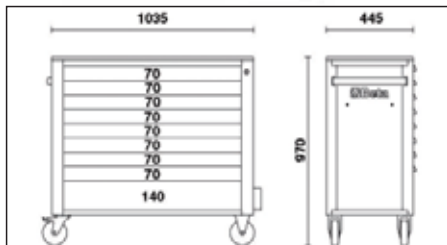
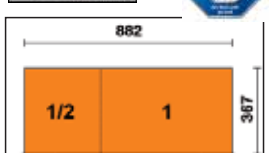
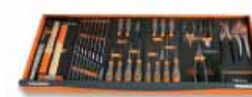

RSC24AXLP/7

cassettiera mobile 7 cassetti con piano di lavoro in legno
e sistema antiribaltamento,
modello lungo

Caratteristiche principali:

- 7 cassetti da 882x367 mm ad estrazione totale, montati su guide telescopiche a sfera:
- 5 cassetti altezza 70 mm
- 1 cassetto altezza 140 mm
- 1 cassetto altezza 210 mm
- Piano di lavoro in legno multistrato con fori per la collocazione di una morsa 1599F/100 o 1599GI/100 (da ordinare separatamente)
- Frontalino in nylon ad alta resistenza, con porta-etichette integrato
- Piano dei cassetti protetto da tappetini di gomma espansa
- Quattro ruote Ø 125 mm di cui 2 fisse e 2 girevoli (una con freno)
- Serratura di sicurezza centralizzata frontale
- Capacità di carico statico pari a 1.100 kg
- Portacarta integrato
- Portaflaconi laterale integrato (applicabile su entrambi i lati)
- Possibilità di inserire in ogni cassetto fino a 6 vassoi morbidi in EVA o termoformati rigidi in ABS

1105 kg



h	max
70 mm	30 kg
140 mm	35 kg
210 mm	35 kg

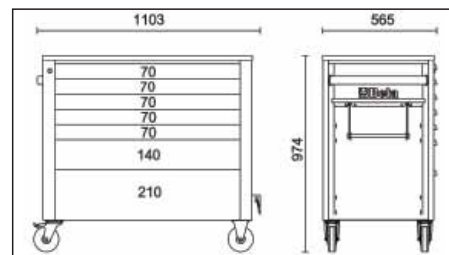
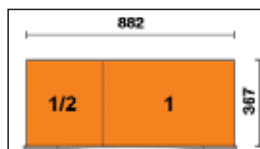
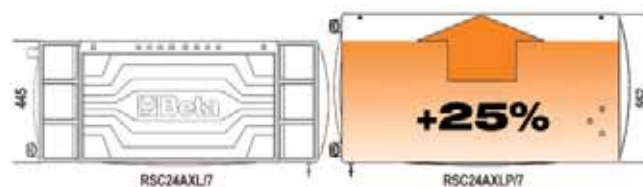

RSC24AXLP/7-O	1.775,00 €	1	024004571
RSC24AXLP/7-R	1.775,00 €	1	024004573
RSC24AXLP/7-A	1.775,00 €	1	024004577

2400 RSC24AXLP/CPR

contenitore portarifiuti per cassettera RSC24AXLP/7

5 kg



2400 RSC24AXLP/CPR	68,50 €	1	024004993
--------------------	---------	---	-----------

2400 RSC24AXLP/PF

pannello forato con supporti per cassettera RSC24AXLP/7

4,5 kg



2400 RSC24AXLP/PF	125,00 €	1	024004992
-------------------	----------	---	-----------

2400 RSC24AXLP/VL

vaschetta laterale portautensili per cassettera RSC24AXLP/7

4 kg

2400 RSC24AXLP/VL	€ 52,50	1	024004995
-------------------	---------	---	-----------



2400 RSC24/PC

portacarta per rotoli preforati per cassettera RSC24, RSC24A, RSC24AXL, RSC51

0,3 kg

2400 RSC24/PC-A	€ 26,00	1	024004903
2400 RSC24/PC-N	€ 26,00	1	024004904



RAL7016 2400 RSC24/PC-A
RAL9005 2400 RSC24/PC-N



2400 RSC24/PD

portadocumenti per cassettera RSC24, RSC24A, RSC24AXL

1,2 kg

2400 RSC24/PD-A	€ 45,50	1	024004907
2400 RSC24/PD-N	€ 45,50	1	024004908



RAL7016 2400 RSC24/PD-A
RAL9005 2400 RSC24/PD-N



2400 RSC24/PF

pannello forato con supporti per cassettera RSC24, RSC24A, RSC51

2,3 kg

2400 RSC24/PF	€ 82,00	1	024004902
---------------	---------	---	-----------

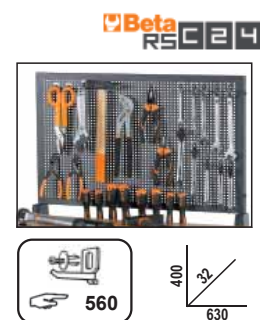

2400 RSC24/PF-

portafaconi per cassettera RSC24, RSC24A

0,5 kg

2400 RSC24/PF-A	€ 27,50	1	024004905
2400 RSC24/PF-N	€ 27,50	1	024004906

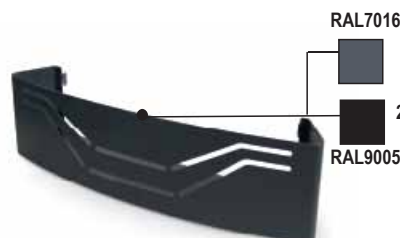

RAL7016 2400S RSC24/PF-A
RAL9005 2400S RSC24/PF-N



2400 RSC24/PL

piano di lavoro in legno per cassettera RSC24, RSC24A, RSC24AXL, RSC51

4,3 kg

2400 RSC24/PL	€ 102,00	1	024004901
---------------	----------	---	-----------



2400 RSC24/SPC

supporto porta computer per cassettera RSC24, RSC24A, RSC24AXLP/7, RSC51

- Con cassetto estraibile
- Non abbinabile al modello RSC24AXL

📦 3,1 kg

2400 RSC24/SPC € 148,50 1 024004909



2400 RSC24/MP

mensola pieghevole per RSC24, RSC24A, RSC24AXLP/7, RSC51

- Utilizzabile come piano di lavoro supplementare
- Piano di lavoro mis. 390x440 mm, protetto con tappetino in gomma antiolio e antibenzina
- Capacità di carico: 20 kg

📦 3,4 kg

2400 RSC24/MP € 78,00 1 024004900



2499PF

portaflaconi

- Abbinabile alle cassette serie C38

📦 2,5 kg

2499PF-O € 76,00 1 024990210
2499PF-G € 76,00 1 024990219
2499PF-R € 76,00 1 024990230

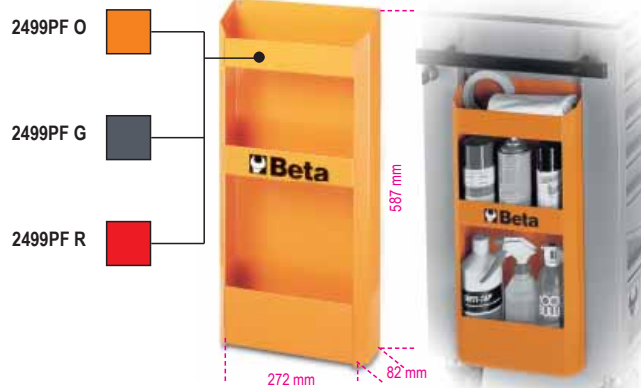

2499PF/M

portaflaconi universale magnetico

📦 2,2 kg

2499PF/M € 69,00 1 024990050



2499PC

portacarta per rotoli preforati

- Abbinabile a tutti i carrelli Tank C25 e alle cassette serie C38.

📦 2,2 kg

2499PC € 81,00 1 024990090



RSC24L/7

cassettiera mobile
con 7 cassetti
e ripiani laterali

Caratteristiche principali:

- 7 cassetti da 588x367 mm, montati su guide telescopiche a sfera: 5 cassetti altezza 70 mm 1 cassetto altezza 140 mm 1 cassetto altezza 210 mm.
- Piano dei cassetti protetto da tappetini di gomma espansa.
- Quattro ruote Ø 125 mm: 2 fisse e 2 girevoli con freno.
- Serratura centralizzata frontale.
- Capacità di carico statico: 1.100 kg.
- Piano di lavoro in legno multistrato con fori per la collocazione di una morsa (1599F/100 - 1599GI/100 da ordinare separatamente).
- Vano laterale con ripiano regolabile in altezza.
- Portacarta integrato.
- Doppio portaflaconi posteriore.
- Portaflaconi laterale integrato

80 kg

		€		
RSC24L/7-O	RAL 2011	1.670,00	1	024004371
RSC24L/7-R	RAL 3000	1.670,00	1	024004373
RSC24L/7-A	RAL 7016	1.670,00	1	024004377

Beta
RSC24

1100
kg



h	max
70 mm	25 kg
140 mm	30 kg
210 mm	30 kg

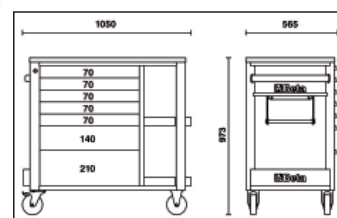
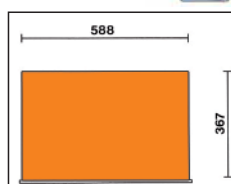

RSC24L-CAB

cassettiera mobile
con sette cassetti
e armadietto porta-oggetti

Caratteristiche principali:

- 7 cassetti da 588x367 mm, montati su guide telescopiche a sfera: 5 cassetti altezza 70 mm 1 cassetto altezza 140 mm 1 cassetto altezza 210 mm.
- Piano dei cassetti protetto da tappetini di gomma espansa.
- Quattro ruote Ø 125 mm: 2 fisse e 2 girevoli con freno.
- Serratura centralizzata frontale.
- Armadietto laterale portaoggetti con anta richiudibile con serratura e ripiano interno regolabile in altezza.
- Capacità di carico statico: 1.100 kg.
- Piano di lavoro in legno multistrato con fori per la collocazione di una morsa (1599F/100 da ordinare separatamente).
- Portacarta integrato.
- Doppio portaflaconi posteriore.
- Portaflaconi laterale integrato

82 kg

		€		
RSC24L-CAB/O	RAL 2011	1.725,00	1	024004471
RSC24L-CAB/R	RAL 3000	1.725,00	1	024004473
RSC24L-CAB/A	RAL 7016	1.725,00	1	024004477

Beta
RSC24

1100
kg



h	max
70 mm	25 kg
140 mm	30 kg
210 mm	30 kg

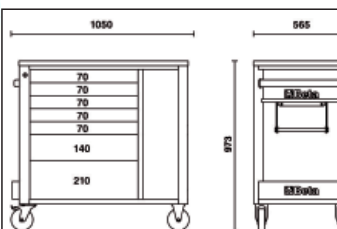
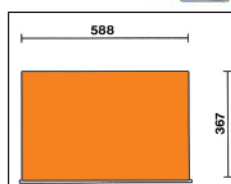

C04TSS-7

cassettiera mobile con sette cassetti
in acciaio inossidabile, **con ruote antitraccia**

Caratteristiche principali:

- Sette cassetti da 570 x 410 mm montati su guide telescopiche a sfera;
- 6 cassetti altezza 83 mm;
- 1 cassetto altezza 170 mm;
- Quattro ruote antitraccia con nucleo in acciaio inossidabile Ø 125mm 2 fisse e 2 girevoli (due con freno);
- Serratura frontale centralizzata;
- Struttura interamente in acciaio inossidabile AISI 304
- Ruote, supporti, sfere, interno dei cassetti e relative guide in acciaio inossidabile
- Maniglia cassetti in alluminio



700
kg

Beta
INOX
STAINLESS STEEL



63 kg

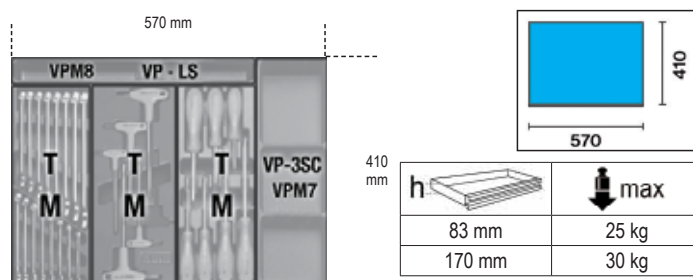

C04TSS/7

€ 2.770,00

1

024003077

303

C25

carrello Tank con mensola

Caratteristiche principali:

- Coperchio di chiusura ribaltabile.
- 1 cassetto scorrevole.
- Piano di alloggiamento utensili protetto da tappetini di gomma espansa.
- Piani di servizio protetti con tappetini in gomma antiolio e antibenzina.
- Quattro ruote Ø 100 mm: 2 fisse e 2 girevoli (una con freno).
- Serratura centralizzata frontale.
- Termoformato vuoto per bussole e accessori da 1/2" (024990104)
- Possibilità di applicazione del portacarta 2499PC.

31,5 kg

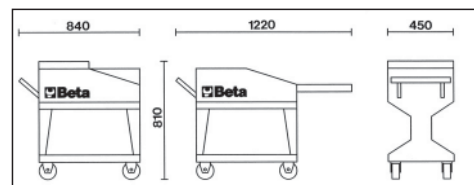

C25

€ 716,00

1

025000001

C27S

carrello portautensili richiudibile per interventi esterni

Struttura in lamiera.

Carrello richiudibile con colonnine ribaltabili per permettere un agevole trasporto.

Modello registrato.

2 cassette 588x277 mm montate su guide telescopiche che permettono l'apertura in due sensi.

Ampio vano portaoggetti inferiore 588x277x220 mm.

2 ruote fisse Ø 160 mm e 2 ruote piroettanti con freno Ø 100 mm

Piano di lavoro termoplastico con 6 vaschette portaminuterie integrate.

Chiusura centralizzata.

Predisposizione per l'alloggiamento di separatori per cassetto e termoformati portautensili MC.

20 kg



C27S-O



C27S-G



C27S-R



h	max
70 mm	20 kg

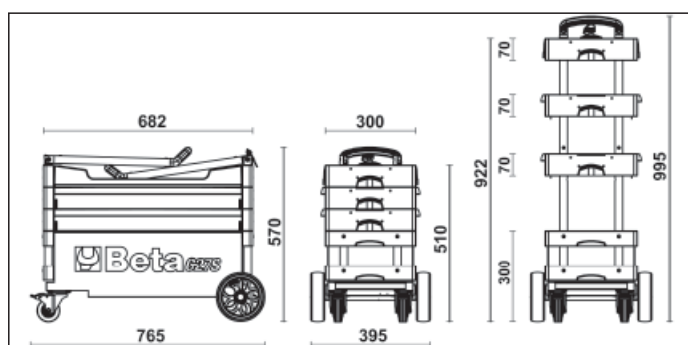
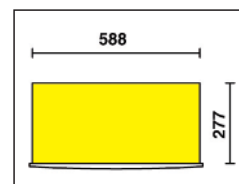

		€		
C27S-O	RAL 2011	803,00	1	027000201
C27S-G	RAL 7016	803,00	1	027000202
C27S-R	RAL 3000	803,00	1	027000203

RSC28

carrello SuperTank con piano di lavoro in legno e 10 cassetti

Caratteristiche principali:

- 10 cassetti da 588x367 mm, montati su guide telescopiche a sfera.
- Sistema rapido e sicuro per l'apertura e chiusura dei cassetti con frontalino in nylon e fibra di vetro.
- Cinque cassetti laterali di cui:
 - 4 cassetti altezza 70 mm
 - 1 cassetto altezza 210 mm.
- Cinque cassetti frontali di cui:
 - 4 cassetti altezza 70 mm
 - 1 cassetto altezza 210 mm.
- Piano dei cassetti protetto da tappetini di gomma espansa.
- Quattro ruote ad alta portata Ø 150 mm: 2 fisse e 2 girevoli con freno.
- 2 serrature di sicurezza centralizzate.
- Piano di lavoro in legno multistrato con fori per la collocazione di una morsa (1599F/150 - 1599GI/150 da ordinare separatamente).
- Vano integrato portaminuterie.
- Vano laterale con antina di chiusura a scomparsa con serratura.
- Portaflaconi integrati.
- Vano passante altezza 135 mm con base ricoperta in materiale plastico.
- Capacità di carico statico: kg 1.200.

130 kg

1200
kg



RSC28-O



RSC28-A



RSC28-R



h	max
70 mm	25 kg
210 mm	30 kg

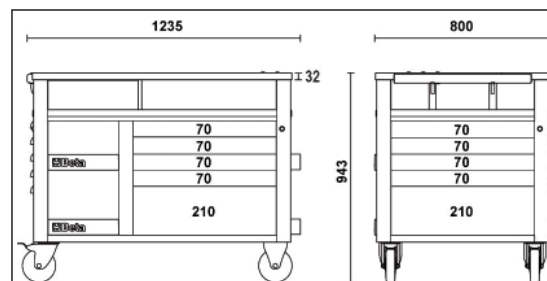
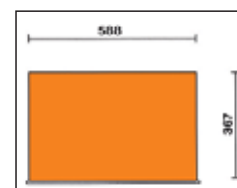

	€		
RSC28-O	3.030,00	1	028003001
RSC28-R	3.030,00	1	028003003
RSC28-A	3.030,00	1	028003007

C30M

postazione di lavoro mobile MaxiTank

Caratteristiche principali:

- 5 cassetti frontali montati su guide telescopiche a sfera:
- 3 cassetti 367x610 mm, altezza 90 mm
- 1 cassetto 588x610 mm, altezza 90 mm
- 1 cassetto 588x610 mm, altezza 180 mm
- Sistema di apertura rapido con frontalino in alluminio.
- Piano dei cassetti protetto da tappetini di gomma espansa.
- Predisposizione per l'inserimento di termoformati.
- Un martinetto idraulico consente, senza sforzo, il sollevamento della parte anteriore e quindi un trasporto agevole.
- Quattro ruote ad alta portata:
- 2 girevoli, anteriori, Ø 150 mm
- 2 fisse, posteriori, Ø 170 mm.
- Piano di lavoro ricoperto in gomma antiolio 1300x800 mm con foro di scarico per la raccolta di liquidi in un piccolo serbatoio.
- Vano passante 720x250x1300 mm con piano ricoperto in PVC, chiuso frontalmente da antine a scomparsa.
- Chiusura centralizzata per cassetti e antine.
- 3 portafiacconi laterali integrati.
- Portacarta integrato
- Capacità di carico statico: kg 1.800.
- Predisposizione per la collocazione di un piano di lavoro in legno multistrato (3000M/PLM) da ordinare separatamente
- Possibilità di collocazione di una morsa 1599F/150. (da ordinare separatamente)

📦 200 kg

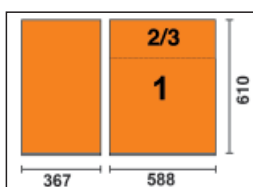

h	max
90 mm	30 kg
180 mm	35 kg

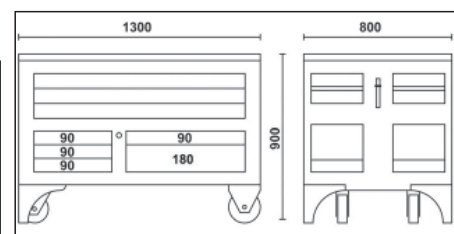

C30M

€ 4.840,00 1 030000300

3000M/PLM

piano di lavoro in legno per C30M, con fori per la collocazione di una morsa 1599F/150

📦 10 kg



1240x740x26 mm

3000M/PLM

€ 470,00 1 030000350

PRATICA E ROBUSTA



- Cassetti ad estrazione totale
- Serratura di sicurezza centralizzata frontale
- Predisposizione per piano di lavoro e separatori per i cassetti, da ordinare separatamente
- Capacità di carico statico: 1200 kg

Modelli disponibili:

- **C35/6GM** (6 cassetti)
- **C35/7GM** (7 cassetti)
- **C35/8GM** (8 cassetti)
- **C35/9GM** (9 cassetti)

Accessori disponibili:



C35/6GM

cassettiera fissa industriale con 6 cassetti

Caratteristiche principali:

• 6 cassetti da 600x447 mm ad estrazione totale:

- 2 cassetti altezza 75 mm
- 1 cassetto altezza 100 mm
- 1 cassetto altezza 150 mm
- 1 cassetto altezza 200 mm
- 1 cassetto altezza 300 mm

• Serratura di sicurezza centralizzata frontale.

• Predisposizione per piano di lavoro e separatori per i cassetti, da ordinare separatamente

75 kg



h	max
75 mm	70 kg
100 mm	70 kg
150 mm	70 kg
200 mm	70 kg
300 mm	70 kg

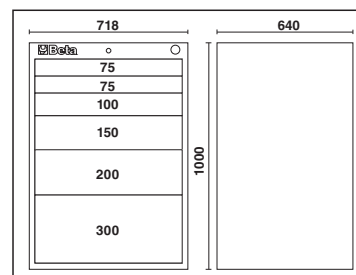
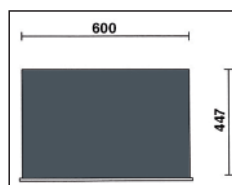

C35/6GM

€ 1.950,00 1 035000162

C35/7GM

cassettiera fissa industriale con 7 cassetti

Caratteristiche principali:

- 7 cassetti da 600x447 mm ad estrazione totale:
- 2 cassetti altezza 75 mm
- 1 cassetto altezza 100 mm
- 3 cassetti altezza 150 mm
- 1 cassetto altezza 200 mm
- Serratura di sicurezza centralizzata frontale.
- Predisposizione per piano di lavoro e separatori per i cassetti, da ordinare separatamente

82 kg

C35/7GM

€ 2.035,00 1 035000172



h	max
75 mm	70 kg
100 mm	70 kg
150 mm	70 kg
200 mm	70 kg

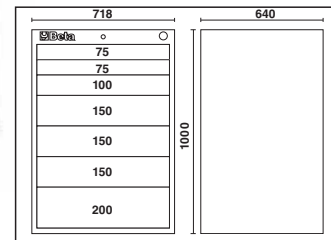

C35/8GM

cassettiera fissa industriale con 8 cassetti

Caratteristiche principali:

- 8 cassetti da 600x447 mm ad estrazione totale:
- 4 cassetti altezza 75 mm
- 1 cassetto altezza 100 mm
- 2 cassetti altezza 150 mm
- 1 cassetto altezza 200 mm
- Serratura di sicurezza centralizzata frontale.
- Predisposizione per piano di lavoro e separatori per i cassetti, da ordinare separatamente

86 kg

C35/8GM

€ 2.170,00 1 035000182



h	max
75 mm	70 kg
100 mm	70 kg
150 mm	70 kg
200 mm	70 kg

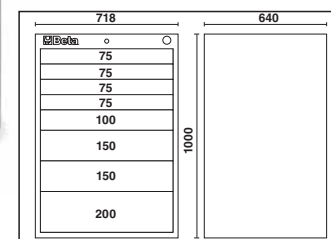
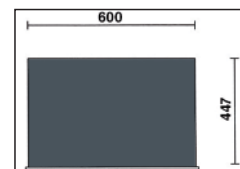

C35/9GM

cassettiera fissa industriale con 9 cassetti

Caratteristiche principali:

- 9 cassetti da 600x447 mm ad estrazione totale:
- 6 cassetti altezza 75 mm
- 3 cassetti altezza 150 mm
- Serratura di sicurezza centralizzata frontale.
- Predisposizione per piano di lavoro e separatori per i cassetti, da ordinare separatamente

91 kg

C35/9GM

€ 2.275,00 1 035000192



h	max
75 mm	70 kg
150 mm	70 kg

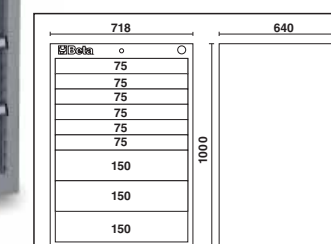
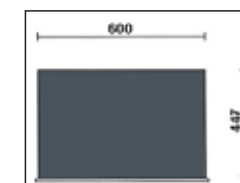

3500/P-M

piano di lavoro con bordo perimetrale per cassettiera C35

3500/P-M

700x600 mm

€ 379,00 1 035000505



PARACOLPI MORBIDI

- Cassetti montati su guide telescopiche a sfera
- Piano di lavoro multifunzione ad alta resistenza
- Sistema di apertura a sgancio rapido in alluminio posizionato su tutta la lunghezza del cassetto
- Portaminuterie e fori per l'alloggiamento dei giravite
- Quattro ruote Ø 125 mm: 2 fisse e 2 girevoli (una con freno)
- Capacità di carico statico: 1000 kg
- Paracolpi angolari morbidi su tutta l'altezza della cassetiera per evitare, in caso di urto, il danneggiamento dei veicoli all'interno dell'officina
- Piano dei cassetti protetto da tappetini di gomma espansa
- Serratura di sicurezza centralizzata frontale
- Portaflaconi e portacarta laterali integrati regolabili in più posizioni

Modelli disponibili:

- C37/6 (6 cassetti)
- C37/7 (7 cassetti)
- C37/8 (8 cassetti)
- C37A/7 (7 cassetti con sistema antiribaltamento)

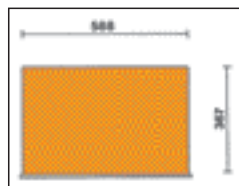

Colori disponibili:

O	RAL 2011
G	RAL 7016
R	RAL 3000

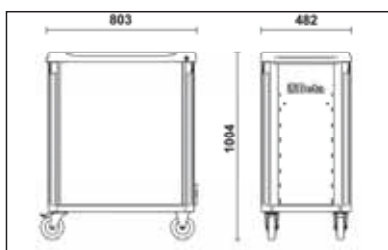

Accessori disponibili:



C37/7

cassetiera mobile con 7 cassetti

Caratteristiche principali:

- 7 cassetti da 588x367 mm, montati su guide telescopiche a sfera:
- 5 cassetti altezza 75 mm
- 1 cassetto altezza 150 mm
- 1 cassetto altezza 225 mm

71 kg

1000 kg



C37/7-O



C37/7-G



C37/7-R



C37/7-O	1.325,00 €	1	037000071
C37/7-G	1.325,00 €	1	037000072
C37/7-R	1.325,00 €	1	037000073

h	max
75 mm	30 kg
150 mm	35 kg
225 mm	35 kg

C37/6

cassettiera mobile
con 6 cassetti

Caratteristiche principali:

- 6 cassetti da 588x367 mm, montati su guide telescopiche a sfera:
- 4 cassetti altezza 75 mm
- 1 cassetto altezza 150 mm
- 1 cassetto altezza 305 mm

69 kg

	€		
C37/6-O	1.280,00	1	037000061
C37/6-G	1.280,00	1	037000062
C37/6-R	1.280,00	1	037000063



C37/6-G



C37/6-R



h	max
75 mm	30 kg
150 mm	35 kg
305 mm	40 kg



C37/8

cassettiera mobile
con 8 cassetti

Caratteristiche principali:

- 8 cassetti da 588x367 mm, montati su guide telescopiche a sfera:
- 6 cassetti altezza 75 mm
- 2 cassetti altezza 150 mm

73 kg

	€		
C37/8-O	1.375,00	1	037000081
C37/8-G	1.375,00	1	037000082
C37/8-R	1.375,00	1	037000083



C37/8-G



C37/8-R



h	max
75 mm	30 kg
150 mm	35 kg



C37A/7

cassettiera mobile

con 7 cassetti con sistema antiribaltamento

Caratteristiche principali:

- 7 cassetti da 588x367 mm, montati su guide telescopiche a sfera:
- 5 cassetti altezza 75 mm
- 1 cassetto altezza 150 mm
- 1 cassetto altezza 225 mm

71 kg

	€		
C37A/7-O	1.360,00	1	037000271
C37A/7-G	1.360,00	1	037000272
C37A/7-R	1.360,00	1	037000273



C37A/7-G



C37A/7-R



h	max
75 mm	30 kg
150 mm	35 kg
225 mm	35 kg



3700/PLA

piano di lavoro in acciaio inossidabile per cassetteria C37

📦 2,8 kg

3700/PLA € 77,00 1 037000100



3700/PLL

piano di lavoro in legno per cassetteria C37

Con predisposizione per la collocazione di una morsa 1599P/100 (da ordinare separatamente)

📦 3,9 kg

3700/PLL € 96,50 1 037000101



≡ 672x396x28 mm

3700/PF

pannello forato con supporti per cassetteria C37

📦 3,2 kg

3700/PF € 76,50 1 037000102



3700/PFL

pannello forato laterale per cassetteria C37

📦 1,9 kg

3700/PFL € 41,00 1 037000104

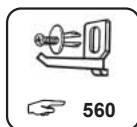

3700/PC

supporto porta computer per cassetteria C37

Con cassetto estraibile

📦 3,1 kg

3700/PC € 104,50 1 037000103



C38

cassettiera mobile
con 11 cassetti

Caratteristiche principali:

- 11 cassetti montati su guide telescopiche a sfera:
 - 1 cassetto 937x410x122 mm
 - 3 cassetti 570x410x74 mm
 - 2 cassetti 570x410x153 mm
 - 3 cassetti 313x410x74 mm
 - 2 cassetti 313x410x153 mm.
- Piano dei cassetti protetto da tappetini di gomma espansa.
- Capacità di carico statico: 1200 kg.
- 4 ruote ad alta portata Ø 125 mm:
 - 2 fisse e 2 girevoli (entrambe con freno a leva).
- Serratura centralizzata frontale.
- Piano di lavoro di lamiera ricoperto da tappetino in gomma.
- Possibilità di applicazione del portacarta 2499PC e del portaflaconi 2499PF.

114 kg



C38-G

C38-R

C38-O



h	max
74 mm	25 kg
153 mm	30 kg

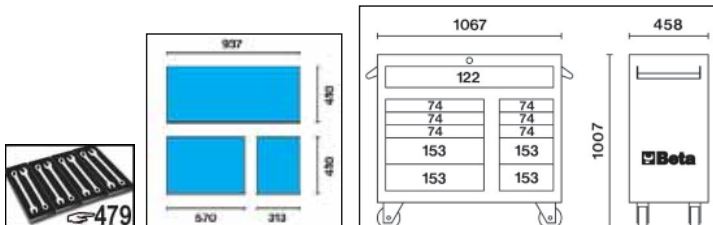

	€		
C38-O	2.095,00	1	038000001
C38-G	2.095,00	1	038000003
C38-R	2.095,00	1	038000002

C38L

cassettiera laterale con 7 cassetti

Caratteristiche principali:

- 7 cassetti da 410x313 mm, montati su guide telescopiche a sfera:
 - 5 cassetti altezza 74 mm
 - 2 cassetti altezza 153 mm.
- Piano dei cassetti protetto da tappetini di gomma espansa.
- Serratura di sicurezza centralizzata frontale.
- Piano di lavoro in alluminio antiscivolo.
- Agganciabile su entrambi i lati del C38.

45 kg

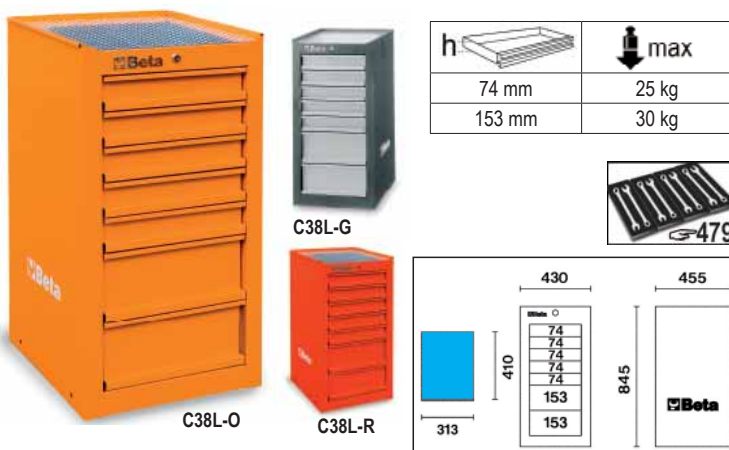

C38L-G

C38L-R

h	max
74 mm	25 kg
153 mm	30 kg

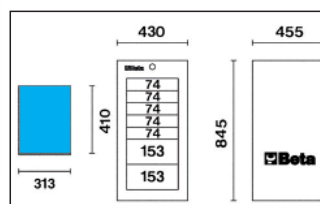

	€		
C38L-O	1.014,00	1	038000081
C38L-G	1.014,00	1	038000083
C38L-R	1.014,00	1	038000082

C38LA

modulo laterale con antina
e scaffale interno

Caratteristiche principali:

- Serratura frontale.
- Scaffale interno regolabile in altezza.
- Tasca portadocumenti posizionata all'interno dell'antina.
- Piano di lavoro in alluminio antiscivolo.
- Agganciabile su entrambi i lati del C38.

18 kg



C38LA-G

C38LA-R

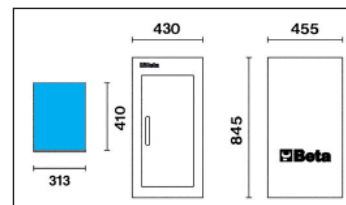

	€		
C38LA O	387,00	1	038000071
C38LA G	387,00	1	038000073
C38LA R	387,00	1	038000072

C38C

cassettiera mobile con 33 cassetti
composta da:

- 1 cassetiera mobile C38
- 2 cassetiere laterali C38L
- 1 cassetiera top C38T

📦 268 kg



C38C-O



C38C-G



C38C-R



h	max
74 mm	25 kg
153 mm	30 kg

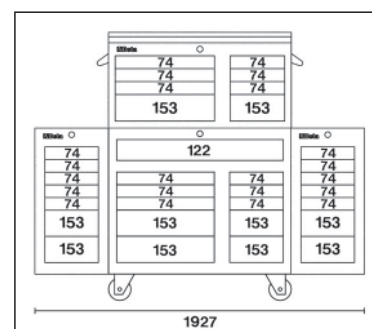
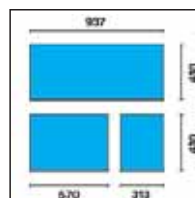

	€		
C38C-O	5.440,00	1	038000201
C38C-G	5.440,00	1	038000203
C38C-R	5.440,00	1	038000202

C38T

cassettiera top
con 8 cassetti e vano portautensili

Caratteristiche principali:

- 8 cassetti montati su guide telescopiche a sfera:
- 3 cassetti 570x410x74 mm
- 1 cassetto 570x410x153 mm
- 3 cassetti 313x410x74 mm
- 1 cassetto 313x410x153 mm.
- Vano portautensili.
- Piano dei cassetti protetto da tappetini di gomma espansa.
- Serratura di sicurezza centralizzata frontale.
- Collocabile sul piano di lavoro del C38.

📦 64 kg



C38T-O



C38T-G



C38T-R

h	max
74 mm	25 kg
153 mm	30 kg

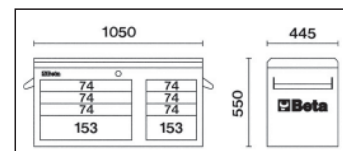
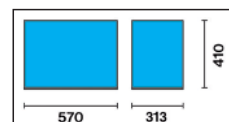

	€		
C38T-O	1.320,00	1	038000091
C38T-G	1.320,00	1	038000093
C38T-R	1.320,00	1	038000092

CASSETTIERA MOBILE C39

STRUTTURA PORTANTE IN LEGA DI ALLUMINIO + RESISTENZA + LEGGEREZZA

- Cassetti montati su guide telescopiche a sfera
- Piano di lavoro termoplastico sul quale è collocabile a misura una cassettera portatile C39T
- Sistema di apertura a sgancio rapido in alluminio posizionato su tutta la lunghezza del cassetto
- Quattro ruote Ø 125 mm: 2 fisse e 2 girevoli (una con freno)
- Capacità di carico statico: 1200 kg
- Piano dei cassetti protetto da tappetini di gomma espansa
- Serratura di sicurezza centralizzata frontale
- Portaminuterie e fori per l'alloggiamento dei giravite
- Portaflaconi laterali e posteriori integrati
- Portacarta integrato



Modelli disponibili:

- C39/6 (6 cassetti)
- C39/7 (7 cassetti)
- C39/8 (8 cassetti)

Colori disponibili:

O	RAL 2011
G	RAL 7016
R	RAL 3000

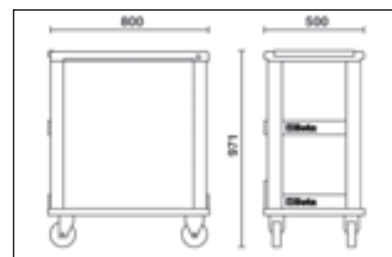
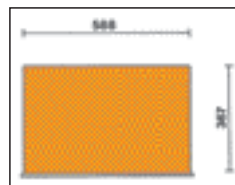

C39/7

cassettera mobile
con 7 cassetti

Caratteristiche principali:

- 7 cassetti da 588x367 mm, montati su guide telescopiche a sfera
- 5 cassetti altezza 70 mm
- 1 cassetto altezza 140 mm.
- 1 cassetto altezza 210 mm

61 kg

1200 kg



C39-7/G



C39-7/R

C39-7/O

h	max
70 mm	30 kg
140 mm	35 kg
210 mm	35 kg



	€		
C39-7/O	1.995,00	1	039000001
C39-7/G	1.995,00	1	039000002
C39-7/R	1.995,00	1	039000003

C39/6

cassettiera mobile con 6 cassetti

Caratteristiche principali:

- 6 cassetti da 588x367 mm, montati su guide telescopiche a sfera:
- 4 cassetti altezza 70 mm
- 1 cassetto altezza 140 mm
- 1 cassetto altezza 280 mm

59 kg

	€		
C39-6/O	1.890,00	1	039000031
C39-6/G	1.890,00	1	039000032
C39-6/R	1.890,00	1	039000033



C39-6/O



C39-6/G



C39-6/R

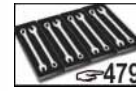

h	max
70 mm	30 kg
140 mm	35 kg
280 mm	40 kg



C39/8

cassettiera mobile con 8 cassetti

Caratteristiche principali:

- 8 cassetti da 588x367 mm, montati su guide telescopiche a sfera:
- 6 cassetti altezza 70 mm
- 2 cassetti altezza 140 mm

64 kg

	€		
C39-8/O	2.130,00	1	039000041
C39-8/G	2.130,00	1	039000042
C39-8/R	2.130,00	1	039000043



C39-8/O



C39-8/G



C39-8/R



h	max
70 mm	30 kg
140 mm	35 kg



C39T

cassettiera portatile con 4 cassetti

Caratteristiche principali:

- 4 cassetti da 588x367 mm, montati su guide telescopiche a sfera:
- 4 cassetti altezza 70 mm
- Serratura centralizzata frontale.
- Montanti e frontalino del cassetto in alluminio.

29 kg

	€		
C39T-O	1.280,00	1	039000101
C39T-G	1.280,00	1	039000102
C39T-R	1.280,00	1	039000103



C39T-O



C39T-R

C39T-G



29 kg

h	max
70 mm	30 kg

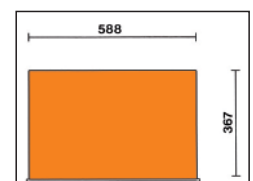
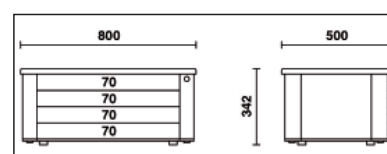

2400-COVER RSC24

Protezione in nylon per cassettera mobile RSC24/RSC24A - C39

2400-COVER RSC24

€ 26,00 1 024000910



2400-COVER RSC24AXL

Protezione in nylon per cassettera mobile RSC24AXL, RSC24L/7, RSC24L-CAB

2400-COVER RSC24AXL

€ 35,50 1 024000930



3700-COVER C37

Protezione in nylon per cassettera mobile C37

3700-COVER C37

€ 34,00 1 037000930



C39SM

cassettiera speciale mobile tipo Racing SM

Caratteristiche tecniche

- Piano di lavoro in legno multistrato
- Serratura di sicurezza centralizzata frontale.
- 4 ruote Ø 125 mm
- 2 fisse e 2 girevoli (una con freno) con copertura a vista
- Capacità di carico statico: 1200 Kg

Modulo con 7 cassetti

da 588x367 mm, montati su guide telescopiche a sfera:

- 6 cassetti altezza 70 mm
- 1 cassetto altezza 240 mm
- Piano dei cassetti protetto da tappetini di gomma espansa.
- Sistema di apertura posizionato su tutta la lunghezza del cassetto.
- Frontalino del cassetto in alluminio.

Modulo di servizio

- Cestino portarifiuti integrato
- Vano portacarta per rotoli integrato
- 1 cassetto portaoggetti 380x305x270 mm

125 kg

		€		
C39SM-O	RAL 2011	3.240,00	1	039390001
C39SM-G	RAL 7016	3.240,00	1	039390002
C39SM-R	RAL 3000	3.240,00	1	039390003

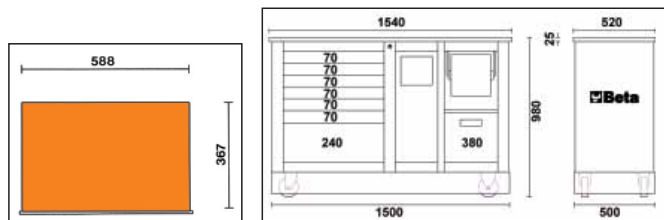

C39MD

cassettiera speciale mobile Racing MD

Caratteristiche tecniche

- Piano di lavoro in legno multistrato
- Serratura di sicurezza centralizzata frontale.
- 4 ruote Ø 125 mm
- 2 fisse e 2 girevoli (una con freno) con copertura a vista
- Capacità di carico statico: 1200 Kg

Modulo con 7 cassetti

da 588x367 mm, montati su guide telescopiche a sfera:

- 6 cassetti altezza 70 mm
- 1 cassetto altezza 240 mm
- Piano dei cassetti protetto da tappetini di gomma espansa.
- Sistema di apertura posizionato su tutta la lunghezza del cassetto.
- Frontalino del cassetto in alluminio.

Modulo con 2 cassetti

da 588x367x270 mm e 588x367x380 mm, montati su guide telescopiche a sfera

- Piano dei cassetti protetto da tappetini di gomma espansa
- Sistema di apertura posizionato su tutta la lunghezza dei cassettoni
- Frontalino dei cassettoni in alluminio.

123 kg

		€		
C39MD-O	RAL 2011	3.340,00	1	039390101
C39MD-G	RAL 7016	3.340,00	1	039390102
C39MD-R	RAL 3000	3.340,00	1	039390103

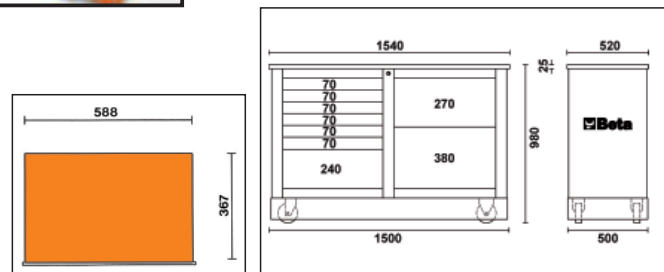

C41S

trolley portautensili
a 2 moduli sovrapponibili

Caratteristiche principali:

- Struttura in lamiera e piani in materiale plastico: grande robustezza e peso ridotto.
- 2 moduli separabili: 1 cestello superiore, 1 modulo con 1 cassetto altezza 95 mm e 1 cassetto altezza 295 mm.
- Ruote di grosso diametro (160 mm), integrate nella struttura per facilitare il trasporto anche su gradini.
- Serratura centralizzata laterale per la chiusura dei 2 cassetti del modulo inferiore.
- Cassetti montati su guide telescopiche a sfera con doppio gancio di chiusura.
- Impugnatura con manico telescopico in alluminio.
- Portaminuterie integrato nel cestello superiore.
- Cassetto inferiore con doppia guida telescopica
- Assortimenti consigliati: 5940/SBK e 5915VU/5

16 kg

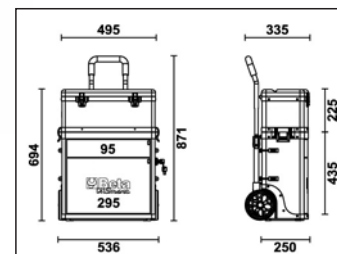

C41S

€ 550,00 1 041000001

C41H

trolley portautensili a 2 moduli sovrapponibili

Caratteristiche principali:

- Struttura in lamiera e piani in materiale plastico: grande robustezza e peso ridotto.
- 2 moduli separabili: 1 cestello superiore, 1 modulo con 2 cassetti altezza 95 mm, 1 cassetta estraibile in materiale plastico altezza 66 mm e 1 cassetto altezza 295 mm.
- Ruote di grosso diametro (160 mm), integrate nella struttura per facilitare il trasporto anche su gradini.
- Serratura centralizzata laterale per la chiusura dei cassetti del modulo inferiore.
- Cassetti montati su guide telescopiche a sfera con doppio gancio di chiusura.
- Impugnatura con manico telescopico in alluminio.
- Portaminuterie integrato
- Cassetto inferiore con doppia guida telescopica

• Assortimenti consigliati: 5940/SBK, 5915VU/5 e 5941VU-M

* Colorazioni disponibili su richiesta

21 kg



C41H-O



C41H-W

C41H-Y

C41H-R

C41H-V

C41H-B

C41H-G

C41H-N

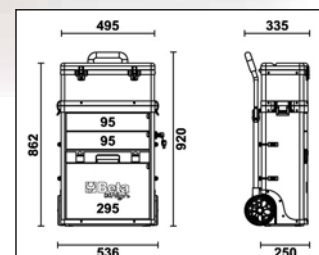
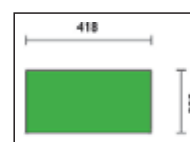

		€		
C41H-O	RAL 2011	622,00	1	041000002
C41H-N	RAL 9005	622,00	1	041000005
C41H-B	RAL 5002	622,00	1	041000006
C41H-R	RAL 3000	622,00	1	041000008
C41H-G	RAL 7016	622,00	1	041000010
C41H-Y	RAL 1023	622,00	1	041000012
C41H-W	RAL 9016	622,00	1	041000021
C41H-V	RAL 6016	622,00	1	041000024

C41H/CE

cassetta portautensili con separatori estraibili per minuterie,
in materiale plastico per trolley C41H

1,3 kg



C41H/CE

€ 39,00 1 041000916

C42H

trolley portautensili a tre moduli sovrapponibili

Caratteristiche principali:

- Struttura in lamiera e materiale plastico: grande robustezza e peso ridotto.
- 3 moduli separabili:
 - 1 cestello superiore, altezza 220 mm
 - 1 modulo portautensili centrale, altezza 180 mm
 - 1 modulo portautensili inferiore con ruote, altezza 330 mm.
- Ruote di grosso diametro (\varnothing 160 mm),
- Manico telescopico regolabile in 3 posizioni.
- Sistema di sgancio rapido dei moduli: agevole e veloce accesso a tutti i diversi scomparti portautensili.
- Cestello superiore con vano portaoggetti interno e 3 portaminuterie integrati nel coperchio
- Predisposizione per essere utilizzato solamente con 2 moduli.
- Assortimenti consigliati: 5940/SBK e 5915VU/5

14 kg

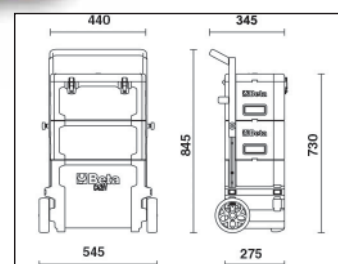

C42H

€ 442,00



1



042000002

Beta

CX49-G

carrello multifunzione

utilizzabile come postazione mobile
per strumenti di diagnosi, laptop, tester e caricabatterie.

Caratteristiche:

- Struttura in lamiera verniciata: massima stabilità e solidità
- Maniglia ergonomica
- Piano di appoggio superiore su 2 livelli
- Cassetto estraibile per mini tastiera
- 2 ripiani centrali con posizione regolabile e 1 ripiano basso fisso
- 4 utili avvolgicavo laterali in plastica
- 2 pratici contenitori laterali
- 2 ruote posteriori fisse Ø 160 mm
- 2 ruote anteriori girevoli Ø 100 mm (una con freno)
- Peso: 43 kg

CX49-G € 820,00 1 049000102

1099 mm
460 mm
435 mm



CA49-G

carrello multifunzione con antenna

utilizzabile come postazione mobile
per strumenti di diagnosi, laptop, tester e caricabatterie.

Caratteristiche:

- Struttura in lamiera verniciata: massima stabilità e solidità
- Maniglia ergonomica
- Piano di appoggio superiore su 2 livelli
- Cassetto estraibile per mini tastiera
- 1 ripiano con posizione regolabile, 1 ripiano fisso e antenna di chiusura
- 4 utili avvolgicavo laterali in plastica
- 2 pratici contenitori laterali
- 2 ruote posteriori fisse Ø 160 mm
- 2 ruote anteriori girevoli Ø 125 mm (una con freno)
- Peso: 36,5 kg

CA49-G € 921,00 1 049000112



1099 mm
460 mm
435 mm

4900-COVER C49

protezione in nylon per carrello multifunzione C49

4900-COVER C49 € 39,00 1 049000930



C48M

carrello contenitore elettrico, con sponde

Le dimensioni ridotte e la versatilità di utilizzo rendono il carrello C48M la soluzione ideale per movimentare in modalità elettroassistita carichi pesanti (scatole, contenitori, oggetti ingombranti, parti di attrezzature) in totale sicurezza, anche in zone di difficile accesso o in ambienti di lavoro dove i tradizionali muletti non possono accedere.

Ne consegue un'importante riduzione dei rischi legati all'incolumità dell'operatore, come per esempio i disturbi muscoloscheletrici causati dalla movimentazione manuale dei carichi.

Pianale motorizzato con motore 24V - 400W con alimentazione a batteria 2x12V 33Ah e scheda di controllo Curtis.

Piano di carico realizzato in solido acciaio, ricoperto con gomma antiscivolo, con sponde tubolari di contenimento a sezione tonda per il trasporto del carico in sicurezza.

Le sponde possono anche essere sfilate, per adattarsi alle singole esigenze di trasporto.

La consolle di comando è dotata di:

- chiave di accensione
- regolazione della velocità
- farfalle laterali per il controllo della trazione
- segnale acustico intermittente che si attiva durante la retromarcia
- indicatore stato di carica della batteria
- pulsante per esclusione freno elettrico
- fungo di emergenza

Dotato di 2 ruote pneumatiche di trazione Ø260mm e 2 ruote in gomma piroettanti Ø150mm, freno elettromagnetico e differenziale.

Carica batterie esterno 220V/50Hz - V/A 24/12 in dotazione

Caratteristiche funzionali

- Capacità di carico: 400 kg
- Velocità di marcia: 4-6 km/h (regolabile)
- Autonomia: 4 ore
- Pendenza massima superabile a pieno carico: 6%
- Pendenza massima superabile con 100 kg di carico: 18%

Dispositivi di sicurezza

- Freno elettronico
- Segnalatore acustico
- Protezione antischiacciamento
- Indicatore dello stato di carica della batteria
- Scheda di controllo Curtis

Caratteristiche tecniche

- Dimensioni di ingombro: mm 1280x630x1100h
- Dimensioni utili piano di carico con sponde: mm 1180x580
- Dimensioni utili piano di carico senza sponde: mm 1260x620
- Altezza pianale di carico dal pavimento: 320 mm
- Altezza vano batteria-pavimento: 65 mm
- Peso con batterie: 140 kg

140 kg

C48M

€ 2.990,00 1 048000230

Beta
BRUTUS

CE

400
kg



1100
630
1280



C48P

carrello pieghevole

Caratteristiche principali:

- Pianale di carico in polipropilene (PP) rinforzato, con rivestimento antiscivolo e inserti in TPV per la protezione degli spigoli
- Maniglia richiudibile per uno stoccaggio rapido e poco ingombrante
- Quattro ruote antitraccia Ø 125 mm: 2 fisse e 2 girevoli con freno
- Portata massima 300 kg.
- Larghezza utile pianale di carico: 705 mm
- Profondità pianale di carico: 480 mm
- Altezza pianale di carico: 200 mm



300
kg



11 kg

C48P

€ 281,00 1 048000030

C51

carrello

- 3 ripiani ricoperti in gomma millerighe antiscivolo
- Maniglia ergonomica
- Doppia possibilità di fissaggio del ripiano centrale
- Quattro ruote Ø 100 mm:
- 2 fisse e 2 girevoli (una con freno).
- Capacità di carico statico: 200 kg. (distribuita sui 3 ripiani)

21 kg

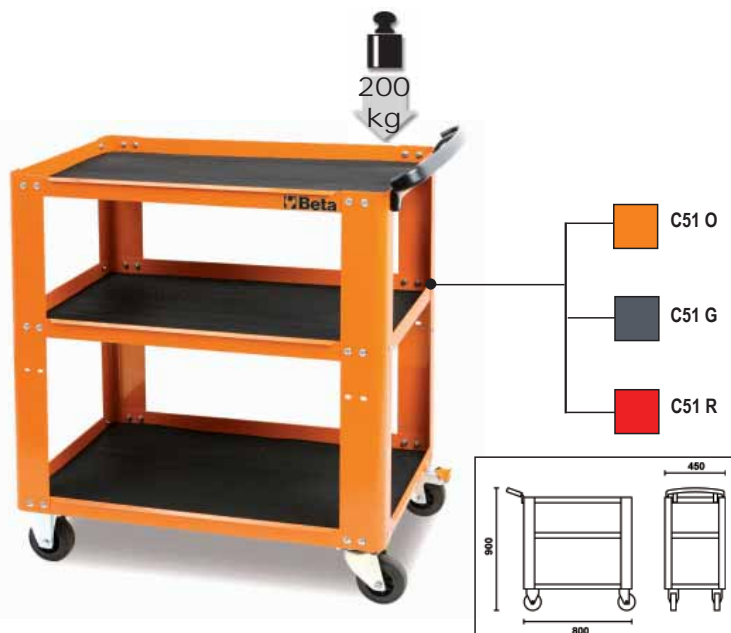

		€		
C51 O	RAL 2011	313,00	1	051000001
C51 G	RAL 7016	313,00	1	051000002
C51 R	RAL 3000	313,00	1	051000003

RSC51

carrello di servizio con 3 cassetti

Caratteristiche principali:

- Piano di lavoro rinforzato in ABS, solido e robusto
- Piano di appoggio multifunzione con bordi anticaduta e 8 fori per l'alloggiamento dei giravite
- 3 cassetti da 588x367 mm, montati su guide telescopiche a sfera, altezza 70 mm
- Piano dei cassetti protetto da tappetini di gomma espansa
- Possibilità di inserire in ogni cassetto fino a 4 vassoi morbidi in EVA o termoformati rigidi in ABS
- Serratura di sicurezza centralizzata frontale
- Pratico portagiravite laterale incluso
- Due portabombolette laterali integrati nella struttura
- Ampio ripiano inferiore protetto con tappetino in gomma antiolio e antibenzina
- Quattro ruote Ø 125 mm: 2 fisse e 2 girevoli (una con freno)

- Capacità di carico statico: 400 kg
- Portata singolo cassetto: 15 kg uniformemente distribuiti

Accessori integrabili:

- Piano di lavoro in legno 2400 RSC24/PL
- Pannello forato portautensili 2400 RSC24/PF
- Supporto porta computer 2400 RSC24/SPC
- Mensola pieghevole 2400 RSC24/MP
- Portacarta per rotoli preforati 2400 RSC24/PC-A

38 kg



		€		
RSC51-FO	RAL 2011	625,00	1	051000300
RSC51-R	RAL 3000	625,00	1	051000303
RSC51-A	RAL 7016	625,00	1	051000307

2400 RSC24/MP

mensola pieghevole per RSC24, RSC24A, RSC24AXLP/7, RSC51

- Utilizzabile come piano di lavoro supplementare
- Piano di lavoro mis. 390x440 mm, protetto con tappetino in gomma antiolio e antibenzina
- Capacità di carico: 20 kg

📦 3,4 kg

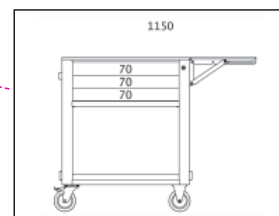

2400 RSC24/MP

€ 78,00 1 024004900

CP51

carrello ad alta resistenza

- 2 ripiani ricoperti da tappetini in gomma
- Maniglia ergonomica
- Quattro ruote Ø 125 mm ad alta resistenza: 2 fisse e 2 girevoli con freno
- Capacità di carico statico: 750 kg. (distribuita sui 2 ripiani)

📦 37 kg

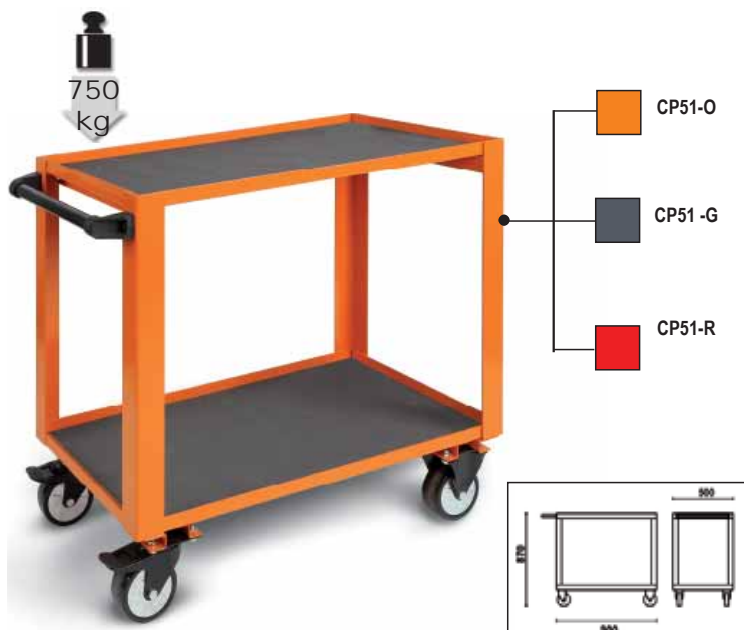

		€		
CP51 O	RAL 2011	414,00	1	051000501
CP51 G	RAL 7016	414,00	1	051000502
CP51 R	RAL 3000	414,00	1	051000503

CB52

carrello per cambi/trasmissioni con recupero liquidi

Il piano inclinato e i fori di scolo permettono il recupero dei liquidi direttamente nella vaschetta di raccolta

Dotato di:

- 4 ruote girevoli di cui 2 con freno
- Cassetto per utensili
- Vaschetta di raccolta liquidi estraibile con capacità 7 litri
- 2 ripiani

📦 60 kg



CB52-O

€ 791,00 1 052000201

C56P O

banco da lavoro pieghevole

Compatto e facilmente trasportabile.
Piano di lavoro 800x500mm (spessore 30 mm) in MDF e lamiera zincata, utilizzabile da entrambi i lati.
Maniglia con protezione in gomma per un agevole trasporto.
Piedini con copertura anti-scivolamento.
Capacità di carico statico: 250 kg

📦 25 kg

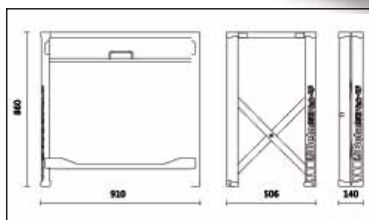

C56P O

€ 436,00 1 056000011

C56PL O

banco da lavoro pieghevole, versione Light

Leggero, compatto e facilmente trasportabile.
Piano di lavoro 800x500mm in lamiera zincata utilizzabile da un solo lato, protetto con rivestimento in gomma antiolio e antibenzina.
Maniglia con protezione in gomma per un agevole trasporto.
Piedini con copertura anti-scivolamento.
Capacità di carico statico: 200 kg

📦 18,5 kg

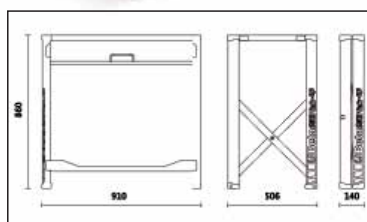

C56PL O

€ 377,00 1 056000021

C54S

armadietti Cargo

Sono realizzati sulla base di accurate ricerche presso qualificati utilizzatori professionali ed offrono le soluzioni ideali per operare in modo confortevole e razionale.
L'apertura dei pannelli forati delle due antine permette lo sfruttamento anche della loro superficie interna.

Caratteristiche principali:

- 1 cassetto montato su guide telescopiche.
- Possibilità di modificare facilmente la disposizione degli utensili in funzione delle proprie esigenze.
- Posizionamento a parete per mezzo di due asole situate posteriormente.
- Serratura per chiusura contemporanea di antine e cassetto.
- Termoformato vuoto per bussole e accessori da 1/2".



C54S-0

37 kg

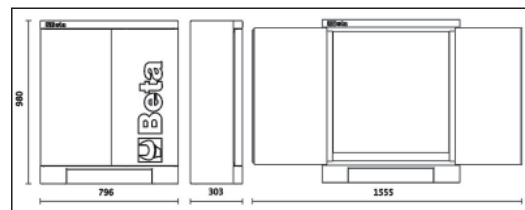
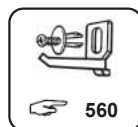

C54S-0

RAL 2011

€ 790,00



1



054000301

 **Beta**

C57SA

banco da lavoro MasterCargo

- Modello con parete portautensili (C57SP) e una cassetiera.

Cassetiera formata da cinque cassetti da 367x588 mm di cui 3 altezza 90 mm, 1 altezza 180 mm e 1 altezza 280 mm montati su guide telescopiche a sfera.

Predisposizione per l'inserimento di termoformati
Serratura centralizzata.

Parete portautensili anche appendibile mediante asole.

Tapparella in alluminio, manovrabile verticalmente, con serratura.

Tre pannelli forati amovibili per il sostegno degli utensili.

Piano di lavoro in legno multistrato, rivestito in laminato plastico con tre fori per la collocazione di una morsa

1599F/150 - 1599GI/150 da ordinare separatamente.

📦 205 kg

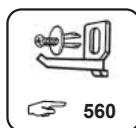

h	max
90 mm	30 kg
180 mm	40 kg
280 mm	40 kg

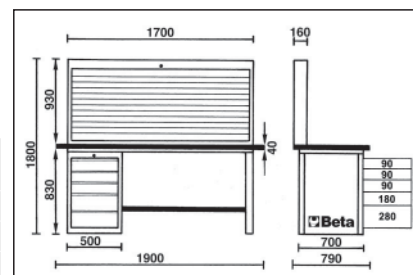

Model	RAL	Price (€)	Weight (kg)	Code
C57S/A-O	RAL 2011	4.970,00	1	057001005
C57S/A-G	RAL 7016	4.970,00	1	057001205
C57S/A-R	RAL 3000	4.970,00	1	057001405

C57SD

banco da lavoro MasterCargo

- Modello con una cassetiera

Cassetiera formata da cinque cassetti da 367x588 mm di cui 3 altezza 90 mm, 1 altezza 180 mm e 1 altezza 280 mm montati su guide telescopiche a sfera.

Predisposizione per l'inserimento di termoformati
Serratura centralizzata.

Piano di lavoro in legno multistrato, rivestito in laminato plastico con tre fori per la collocazione di una morsa

1599F/150 - 1599GI/150 da ordinare separatamente.

📦 158 kg



h	max
90 mm	30 kg
180 mm	40 kg
280 mm	40 kg



Model	RAL	Price (€)	Weight (kg)	Code
C57S/D-O	RAL 2011	3.510,00	1	057001004
C57S/D-G	RAL 7016	3.510,00	1	057001204
C57S/D-R	RAL 3000	3.510,00	1	057001404

C57SB

banco da lavoro MasterCargo

- Modello con parete portautensili (C57SP) e due cassettiere.

Cassettiera formata da cinque cassetti da 367x588 mm di cui 3 altezza 90 mm, 1 altezza 180 mm e 1 altezza 280 mm montati su guide telescopiche a sfera.

Predisposizione per l'inserimento di termoformati
Serratura centralizzata.

Parete portautensili anche appendibile mediante asole.

Tapparella in alluminio, manovrabile verticalmente, con serratura.

Tre pannelli forati amovibili per il sostegno degli utensili.

Piano di lavoro in legno multistrato, rivestito in laminato plastico con tre fori per la collocazione di una morsa 1599F/150 - 1599GI/150 da ordinare separatamente.



C57S/B-O

243 kg



C57S/B-G



C57S/B-R



h	max
90 mm	30 kg
180 mm	40 kg
280 mm	40 kg

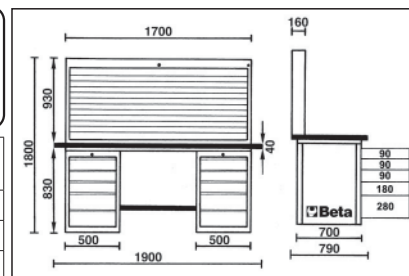

		€		
C57S/B-O	RAL 2011	6.190,00	1	057001006
C57S/B-G	RAL 7016	6.190,00	1	057001206
C57S/B-R	RAL 3000	6.190,00	1	057001406

C57SC

banco da lavoro MasterCargo

- Modello con due cassettiere.

Cassettiera formata da cinque cassetti da 367x588 mm di cui 3 altezza 90 mm, 1 altezza 180 mm e 1 altezza 280 mm montati su guide telescopiche a sfera.

Predisposizione per l'inserimento di termoformati
Serratura centralizzata.

Piano di lavoro in legno multistrato, rivestito in laminato plastico con tre fori per la collocazione di una morsa 1599F/150 - 1599GI/150 da ordinare separatamente.



C57S/C-O

196 kg



h	max
90 mm	30 kg
180 mm	40 kg
280 mm	40 kg



C57S/C-G



C57S/C-R

		€		
C57S/C-O	RAL 2011	4.730,00	1	057001003
C57S/C-G	RAL 7016	4.730,00	1	057001203
C57S/C-R	RAL 3000	4.730,00	1	057001403

C57SP

parete portautensili MasterCargo

- Parete portautensili anche appendibile mediante asole.
- Tapparella in alluminio, manovrabile verticalmente, con serratura.
- Tre pannelli forati amovibili per il sostegno degli utensili.

📦 46 kg

		€	📦	🚚
C57SP-O	RAL 2011	1.460,00	1	057001020
C57SP-G	RAL 7016	1.460,00	1	057001220
C57SP-R	RAL 3000	1.460,00	1	057001420

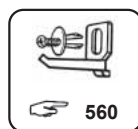

C57SP G

C57SP R

5700LAMP

lampada per banco MasterCargo

- Robusta struttura in lamiera composta da quattro elementi; completa di viti per l'assemblaggio.
- Portalampana con striscia LED da 1120 Lumen, 4000K, 14W
- Alimentazione 230V.
- Fornito senza cavo.

📦 9 kg

	€	📦	🚚
5700LAMP	360,00	1	057000005

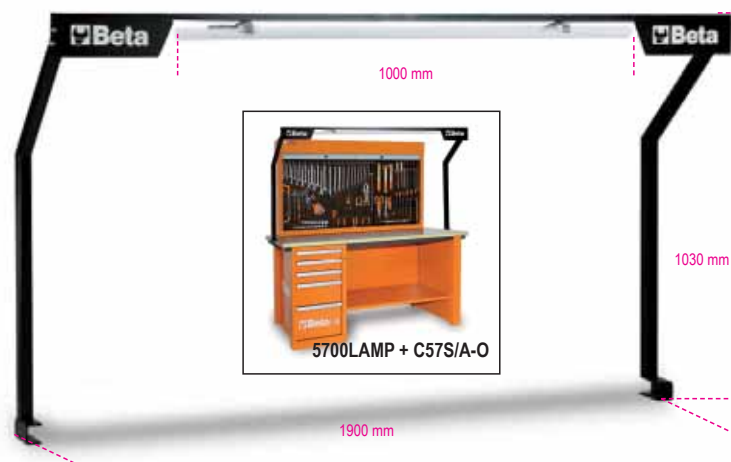

C58P

parete portautensili

- Soluzione con chiusura a tapparella in alluminio verniciato e serratura di chiusura.
- Due pannelli forati amovibili per il sostegno degli utensili.

📦 46,8 kg

		€	📦	🚚
C58P-O	RAL 2011	1.107,00	1	058000221
C58P-G	RAL 7016	1.107,00	1	058000222
C58P-R	RAL 3000	1.107,00	1	058000223



C58P-G



C58P-R

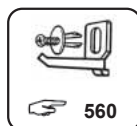

C58P-O

PV

pannello portautensili da parete

	LxA mm		€	📦	🚚
PV1	1000x920	10,2	207,00	1	088880010
PV1,5	1500x920	14,2	274,00	1	088880015



C56W

banco da lavoro con piano di lavoro in legno

- Piano di lavoro in legno multistrato con fori per la collocazione di una morsa 1599F/125 - 1599GI/125 (da ordinare separatamente)
- Struttura in acciaio con 6 gambe di sostegno
- Capacità di carico statico: 1.200 kg
- Abbinabile alla parete C57SP (non fissabile al piano di lavoro).
- Due cassetti dotati di serratura.
- Predisposizione per il fissaggio al pavimento.

📦 86 kg



		€	📦	📄
C56W-O	RAL 2011	1.220,00	1	056000251
C56W-G	RAL 7016	1.220,00	1	056000252
C56W-R	RAL 3000	1.220,00	1	056000253

C56B

banco da lavoro con piano in legno

Caratteristiche principali:

- Piano di lavoro in legno multistrato con fori per la collocazione di una morsa 1599F/125 - 1599GI/125 (da ordinare separatamente).
- Struttura in acciaio con 4 gambe di sostegno
- Capacità di carico statico: 600 kg.
- Ripiano inferiore portaoggetti con capacità di carico 150 kg. (uniformemente distribuiti)
- Predisposizione per il fissaggio al pavimento

📦 54,5 kg



		€	📦	📄
C56B-O	RAL 2011	725,00	1	056000401
C56B-G	RAL 7016	725,00	1	056000402
C56B-R	RAL 3000	725,00	1	056000403

C56

banco da lavoro

- Piano di lavoro in lamiera verniciata con bordo perimetrale
- Struttura in acciaio con 6 gambe di sostegno
- Capacità di carico statico: 1.200 kg
- Abbinabile alla parete C57SP non fissabile al piano di lavoro.
- Due cassetti dotati di serratura.
- Predisposizione per il fissaggio al pavimento.

📦 82 kg



		€	📦	📄
C56-O	RAL 2011	1.028,00	1	056000201
C56-G	RAL 7016	1.028,00	1	056000202
C56-R	RAL 3000	1.028,00	1	056000203

C56M

banco da lavoro

- Piano di lavoro in metallo rivestito per metà da lastra in alluminio antiscivolo e per metà da tappeto in gomma asportabile.
- Sottopiano in massello di legno.
- Capacità di carico statico: 800 kg
- Abbinabile alla parete C57SP non fissabile al piano di lavoro.
- Tre cassetti dotati di serratura.
- Predisposizione per il fissaggio al pavimento.

📦 95 kg



		€	📦	🏠
C56M O	RAL 2011	1.485,00	1	056000050
C56M G	RAL 7016	1.485,00	1	056000053
C56M R	RAL 3000	1.485,00	1	056000054

C58B

banco da lavoro con piano in legno

Caratteristiche principali:

- Piano di lavoro in legno multistrato con fori per la collocazione di una morsa 1599F/125 - 1599GI/125 (da ordinare separatamente).
- Struttura in acciaio con 4 gambe di sostegno
- Capacità di carico statico: 800 kg.
- Ripiano inferiore portaoggetti con capacità di carico 150 kg. (uniformemente distribuiti)
- Predisposizione per il fissaggio al pavimento

📦 44 kg



		€	📦	🏠
C58B-O	RAL 2011	650,00	1	058000401
C58B-G	RAL 7016	650,00	1	058000402
C58B-R	RAL 3000	650,00	1	058000403

C58M

banco da lavoro

- Piano di lavoro in metallo interamente rivestito da un tappetino in gomma antiscivolo asportabile.
- Sottopiano in massello di legno.
- Capacità di carico statico: 800 kg.
- 2 cassetti dotati di serratura.
- Predisposizione per il fissaggio al pavimento.
- Possibilità di applicazione opzionale del piano di lavoro in alluminio C58M/PA.

📦 65 kg



		€	📦	🏠
C58M-O	RAL 2011	954,00	1	058000300
C58M-G	RAL 7016	954,00	1	058000302
C58M-R	RAL 3000	954,00	1	058000303

C59A

banco da lavoro "Endurance" con 1 cassetiera da 6 cassetti

Caratteristiche principali:

- Ripiano in legno multistrato con fori per la collocazione di una morsa 1599F/125 - 1599GI/125 (da ordinare separatamente).
- 6 cassetti 588x367 mm, montati su guide telescopiche a sfera:
 - 4 cassetti altezza 70 mm
 - 1 cassetto altezza 140 mm
 - 1 cassetto altezza 280 mm
- Piano dei cassetti protetto da tappetini di gomma espansa.
- Frontalino dei cassetti in Nylon ad alta resistenza.
- Cassettiere predisposte per l'inserimento di termoformati.
- Serratura di sicurezza centralizzata frontale.
- Ripiano inferiore portaoggetti.
- Predisposizione per portacarta (2400 RSC24/PC) e portafaconi (2400 RSC24/PF-) da ordinare separatamente.

115 kg



C59A O



C59A A



C59A R

1500 kg



h	max
70 mm	25 kg
140 mm	30 kg
280 mm	35 kg

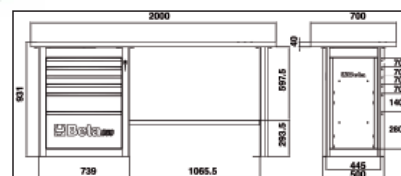

		€		
C59A-O	RAL 2011	1.960,00	1	059000011
C59A-A	RAL 7016	1.960,00	1	059000031
C59A-R	RAL 3000	1.960,00	1	059000051

C59B

banco da lavoro "Endurance" con 2 cassettiere da 6 cassetti

Caratteristiche principali:

- Ripiano in legno multistrato con fori per la collocazione di una morsa 1599F/125 - 1599GI/125 (da ordinare separatamente).
- 12 cassetti 588x367 mm, montati su guide telescopiche a sfera:
 - 8 cassetti altezza 70 mm
 - 2 cassetti altezza 140 mm
 - 2 cassetti altezza 280 mm
- Piano dei cassetti protetto da tappetini di gomma espansa.
- Possibilità di inserimento termoformati.
- Serratura di sicurezza centralizzata frontale.
- Ripiano inferiore portaoggetti.
- Predisposizione per portacarta (2400 RSC24/PC) e portafaconi (2400 RSC24/PF-) da ordinare separatamente.

155 kg



C59B O



C59B A



C59B R

1500 kg

h	max
70 mm	25 kg
140 mm	30 kg
280 mm	35 kg



		€		
C59B-O	RAL 2011	2.600,00	1	059000012
C59B-R	RAL 3000	2.600,00	1	059000052
C59B-A	RAL 7016	2.600,00	1	059000032

C59C

banco da lavoro "Endurance" con 1 cassetiera da 6 cassetti, modello corto

Caratteristiche principali:

- Ripiano in legno multistrato con fori per la collocazione di una morsa 1599F/125 - 1599GI/125 (da ordinare separatamente).
- 6 cassetti 588x367 mm, montati su guide telescopiche a sfera:
- 4 cassetti altezza 70 mm
- 1 cassetto altezza 140 mm
- 1 cassetto altezza 280 mm
- Piano dei cassetti protetto da tappetini di gomma espansa.
- Possibilità di inserimento termoformati.
- Serratura di sicurezza centralizzata frontale.
- Ripiano inferiore portaoggetti.
- Predisposizione per portacarta (2400 RSC24/PC) e portafaconi (2400 RSC24/PF-) da ordinare separatamente.



105 kg

		€		
C59C-O	RAL 2011	1.770,00	1	059000013
C59C-R	RAL 3000	1.770,00	1	059000053
C59C-A	RAL 7016	1.770,00	1	059000033

h	max
70 mm	25 kg
140 mm	30 kg
280 mm	35 kg

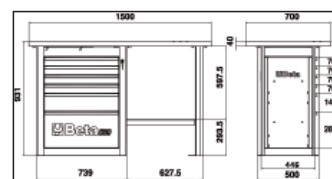

9562T2

tappeto per banco da lavoro 200x160 cm

- protegge il suolo da perdite d'olio, benzina e rispetta l'ambiente
- facile da pulire, fondo gommato ed antiscivolo

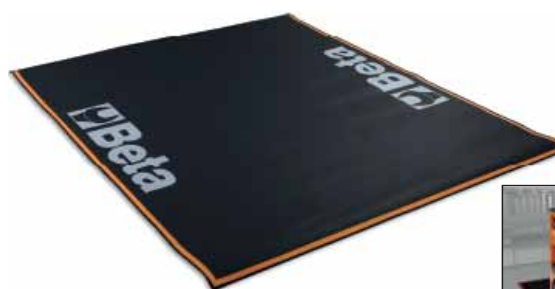

	L cm	€		
9562T2	200	247,50	1	095620200

Beta



ARREDO OFFICINA



Beta Utensili, per rispondere alle esigenze di un mercato che sempre più ricerca qualità, design e personalizzazione, ha creato "Racing System C55": un arredo per officina modulare che vi offre la possibilità di creare un ambiente di lavoro moderno, modellato sulle vostre necessità.

Qualità

La migliore qualità Beta "Made in Italy"
per arredare la tua officina

Organizzazione

Una postazione organizzata in maniera razionale
consente di ottimizzare il lavoro



Modularità

Officina componibile in base ai vostri spazi
e alle vostre esigenze

Design

Finiture ricercate ed accattivanti per rendere il posto
di lavoro un ambiente ordinato e gradevole





MADE IN ITALY

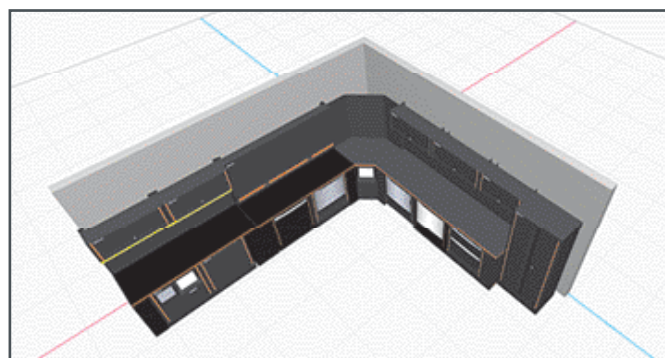

Configura on-line la tua officina
Vai su **www.rsc55.com**



L'officina con i tuoi colori!

RSC55 ti offre la possibilità di ordinare i banchi e la parete con tapparella in versione neutra (grigia) e di completare la tua personalizzazione con gli inserti colorati verticali da ordinare tra 7 differenti nastri adesivi.

**1. Ordina i tuoi moduli
con colorazione neutra**

2. Ordina l'inserto verticale

Scegli il colore secondo i tuoi gusti o in base ai colori sociali della tua azienda

C55
combinazione completa arredo officina



Combinazione completa composta da:

- Armadio ad 1 anta (C55A1)
- Armadio a 2 ante (C55A2)
- Banco da lavoro (C55BO/2)
- Banco da lavoro con prese (C55PRO BO/2)
- Cassettiera mobile con 7 cassetti (C55C7)
- Modulo fisso con 2 cassettoni (C55M2)
- Modulo fisso con 7 cassetti (C55M7)
- Modulo fisso di servizio (C55MS)
- Parete con pensili (C55/2PM)
- Parete portautensili con tapparella (C55PS-O)

C55AB

combinazione arredo officina

Combinazione composta da:

- Armadio a 2 ante (C55A2)
- Banco da lavoro (C55BO/2)
- Modulo fisso con 7 cassetti (C55M7)
- Modulo fisso di servizio (C55MS)
- Parete con pensili (C55/2PM)

407 kg



C55AB

€ 10.360,00 1 055000020



C55PB/3

combinazione arredo officina

Combinazione composta da:

- Banco da lavoro (C55BO/2)
- Cassettiera mobile con 8 cassetti (C55C8)
- Modulo fisso con 2 cassettoni (C55M2)
- Parete portautensili con tapparella (C55PS-O)

334 kg



C55PB/3

€ 8.730,00 1 055000035



C55PB-PRO/7

Postazione di lavoro per arredo officina RSC55

Composta da:

C55B

Banco con piano da lavoro 2050x700 mm rivestito da uno strato di ABS antiurto e antigraffio resistente ad olii e idrocarburi.

Dotato di:

- Fori per la collocazione di una morsa 1599F/150 (da ordinare separatamente)
- Piedini regolabili in altezza

C55M7

modulo fisso con sette cassetti da 588x367 mm, montati su guide telescopiche a sfera

- Sistema di apertura in alluminio posizionato su tutta la lunghezza del cassetto
- Piano dei cassetti protetto da tappetini di gomma espansa
- Serratura centralizzata frontale
- Predisposizione per l'inserimento dei termoformati

C55MS

modulo fisso di servizio

- Cestino portarifiuti integrato
- Vano portacarta per rotoli preforati
- Cassettone portaoggetti 305x270 mm

C55/2PM + C55/PF

parete con 2 pensili

- 2 pensili 1024x400x300mm dotati di molle a gas
- 2 pannelli sotto pensile 1024x620x25mm
- 2 pannelli forati sotto pensile 1024x620x25mm per il sostegno degli utensili

350 kg

C55PB-PRO/7

9.800,00



1



055000065



C55PB-PRO/8

Postazione di lavoro per arredo officina RSC55

Composta da:

C55B

Banco con piano da lavoro 2050x700 mm rivestito da uno strato di ABS antiurto e antigraffio resistente ad olii e idrocarburi.

Dotato di:

- Fori per la collocazione di una morsa 1599F/150 (da ordinare separatamente)
- Piedini regolabili in altezza

C55C7

cassetiera mobile con sette cassetti da 588x367 mm, montati su guide telescopiche a sfera

- 4 ruote Ø 100 mm, 2 fisse e 2 girevoli (una con freno)
- Sistema di apertura in alluminio posizionato su tutta la lunghezza del cassetto
- Piano dei cassetti protetto da tappetini di gomma espansa
- Serratura centralizzata frontale
- Predisposizione per l'inserimento dei termoformati

C55MA

modulo fisso con 2 antine

- Sistema di apertura push & pull a pressione
- Dotato di serratura
- Ripiano interno regolabile in altezza

C55PS

parete portautensili con tapparella e struttura portante

- Tapparella in alluminio, manovrabile verticalmente, con serratura
- Pannello forato amovibile per il sostegno degli utensili

347 kg

C55PB-PRO/8

8.430,00



1



055000066



C55B/2

banco da lavoro da 2 metri per arredo officina

Con piano da lavoro 2050x700 mm rivestito da uno strato di PVC antiurto e antigraffio resistente agli idrocarburi

- Fori per la collocazione di una morsa 1599F/150 - 1599GI/150 (da ordinare separatamente)
- Piedini regolabili in altezza

105 kg

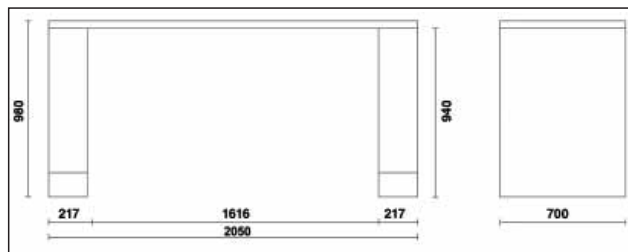
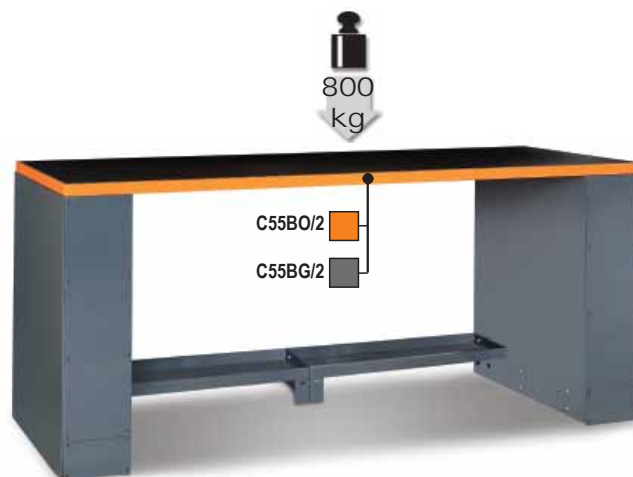

C55BO/2	€ 2.405,00	1	055000101
C55BG/2	€ 2.405,00	1	055000111

C55PRO B/2

banco da lavoro da 2 metri per arredo officina

Con piano da lavoro 2050x700 mm rivestito da uno strato di PVC antiurto e antigraffio resistente agli idrocarburi

Prese elettriche e arrotolatore integrati:

- Presa Schuko+16+10A
- Presa EU Plug 10A
- Presa per aria compressa con arrotolatore da Ø 8 mm, lunghezza tubo: 10 m.
- Fori per la collocazione di una morsa Art. 1599F/150 - 1599GI/150 (da ordinare separatamente)
- Piedini regolabili in altezza

110 kg

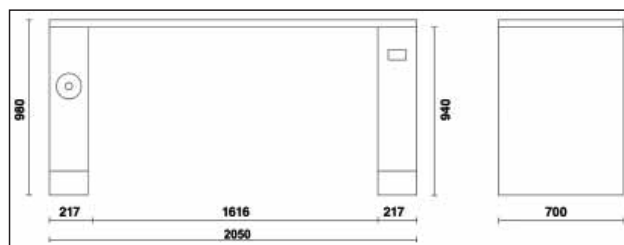
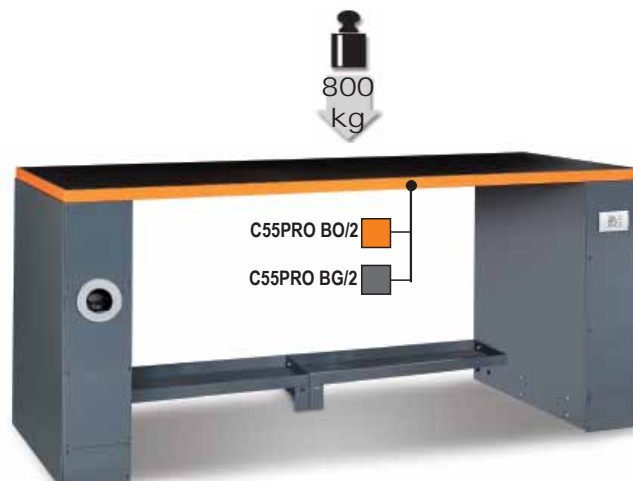

C55PRO BO/2	€ 2.940,00	1	055000151
C55PRO BG/2	€ 2.940,00	1	055000171

C55B/2,8

banco da lavoro da 2,8 metri per arredo officina

Con piano da lavoro 2850x700 mm rivestito da uno strato di PVC antiurto e antigraffio resistente agli idrocarburi

- Fori per la collocazione di una morsa 1599F/150 - 1599GI/150 (da ordinare separatamente)
- Piedini regolabili in altezza

📦 129 kg

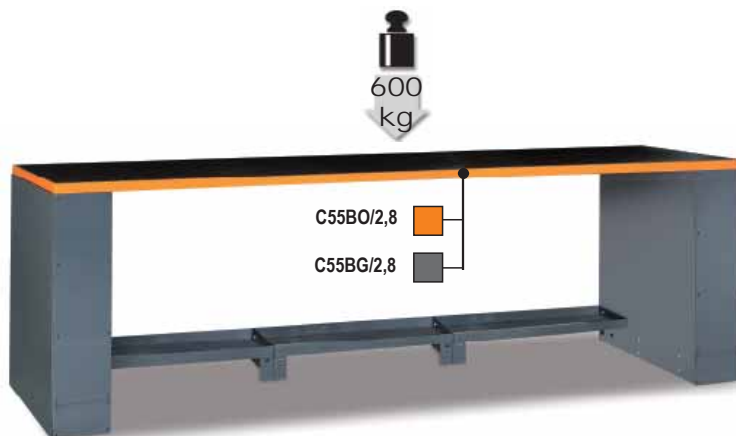

C55BO/2,8

C55BG/2,8

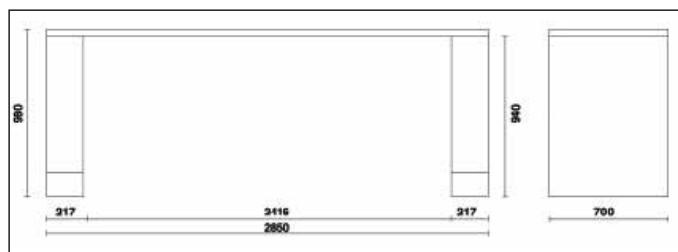

C55BO/2,8	€ 3.020,00	1	055000261
C55BG/2,8	€ 3.020,00	1	055000281

C55PRO B/2,8

banco da lavoro da 2,8 metri per arredo officina

Con piano da lavoro 2850x700 mm rivestito da uno strato di PVC antiurto e antigraffio resistente agli idrocarburi

Prese elettriche e arrotolatore integrati:

- Presa Schuko+16+10A
- Presa EU Plug 10A
- Presa per aria compressa con arrotolatore da Ø 8 mm, lunghezza tubo: 10 m.
- Fori per la collocazione di una morsa Art. 1599F/150 - 1599GI/150 (da ordinare separatamente)
- Piedini regolabili in altezza

📦 134 kg

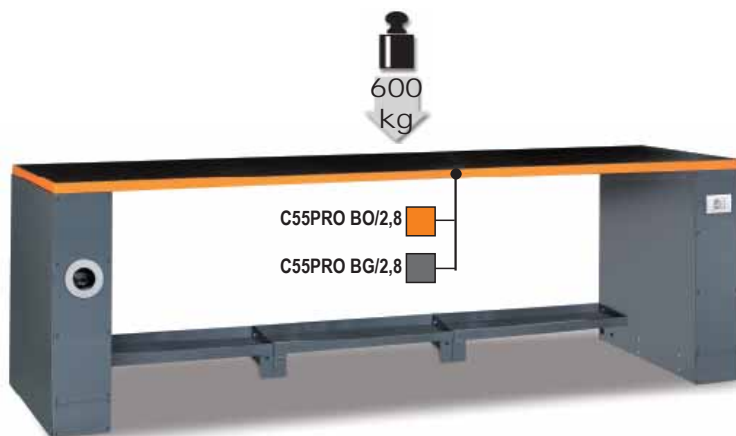

C55PRO BO/2,8

C55PRO BG/2,8

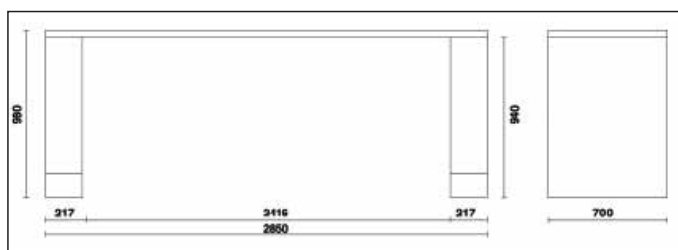

C55PRO BO/2,8	€ 3.550,00	1	055000271
C55PRO BG/2,8	€ 3.550,00	1	055000283

C55B-D4

banco da lavoro doppio da 4 metri con gamba centrale

Con piano da lavoro 4100x700 mm rivestito da uno strato di PVC antiurto e antigraffio resistente agli idrocarburi

- Fori per la collocazione di una morsa 1599F/150 - 1599GI/150 (da ordinare separatamente)
- Piedini regolabili in altezza
- Gamba doppia centrale con vano-portaoggetti e sportello di chiusura 365x750 mm

185 kg

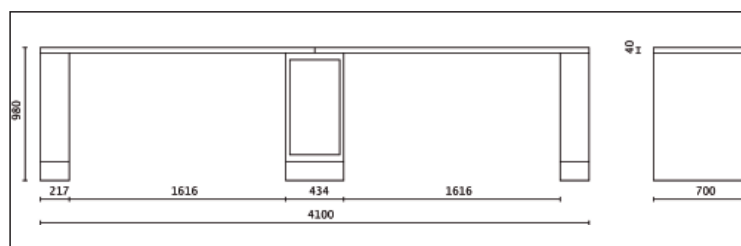

C55BO/D4	€ 4.890,00	1	055000109
C55BG/D4	€ 4.890,00	1	055000119

C55PRO B-D4

banco da lavoro doppio da 4 metri con gamba centrale

Con piano da lavoro 4100x700 mm rivestito da uno strato di PVC antiurto e antigraffio resistente agli idrocarburi

Prese elettriche e arrotolatore integrati:

- Presa Schuko+16+10A
- Presa EU Plug 10A
- Presa per aria compressa con arrotolatore da Ø 8 mm, lunghezza cavo: 10 m.
- Fori per la collocazione di una morsa Art. 1599F/150 - 1599GI/150 (da ordinare separatamente)
- Piedini regolabili in altezza
- Gamba doppia centrale con vano-portaoggetti e sportello di chiusura 365x750 mm

190 kg

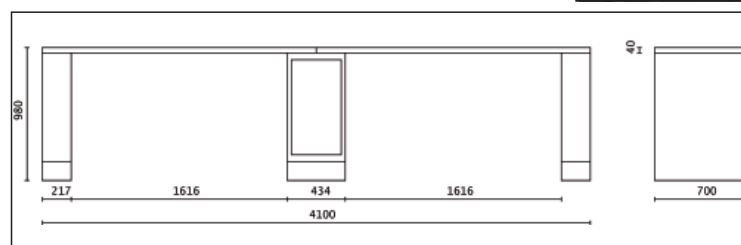
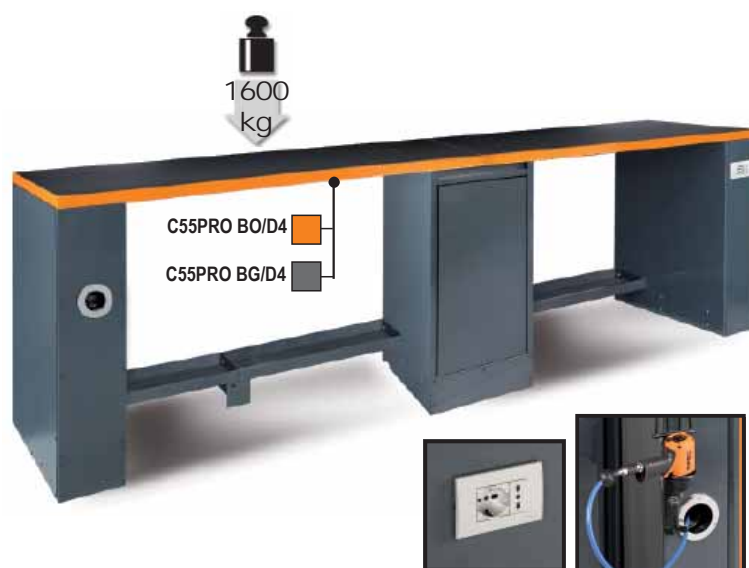

C55PRO-BO/D4	€ 5.430,00	1	055000159
C55PRO-BG/D4	€ 5.430,00	1	055000179

 **Beta**

C55B/G

gamba universale per banco da lavoro arredo officina

- Dotata di piedini regolabili in altezza
- Accesso frontale e laterale
- Utilizzabile per entrambi i lati del banco di lavoro

📦 30 kg

C55B/G € 647,00 1 055000096

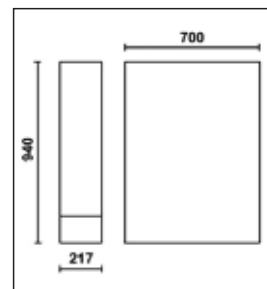

C55B/GAA

gamba universale per banco da lavoro con avvolgitubo integrato

- Avvolgitubo automatico integrato per aria compressa o acqua fredda da Ø 8 mm
- Lunghezza tubo: 10 m
- Dotata di piedini regolabili in altezza
- Accesso frontale e laterale

📦 35 kg

C55B/GAA € 1.033,00 1 055000099

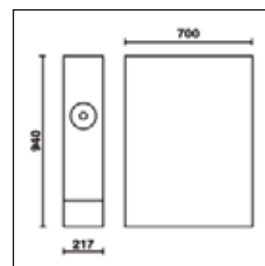

C55B/GDP

gamba doppia per banchi di lavoro adiacenti per arredo officina

- Vano portacarta per rotoli preforati
- Vano portaoggetti con antina
- Dotata di piedini regolabili in altezza

📦 45 kg

C55B/GDP € 1.535,00 1 055000292

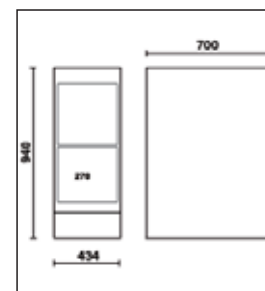

C55B/GDS

gamba doppia per banchi di lavoro adiacenti per arredo officina

- Vano porta-oggetti con sportello 365x750 mm
- Dotata di piedini regolabili in altezza

📦 45 kg

C55B/GDS € 1.380,00 1 055000291

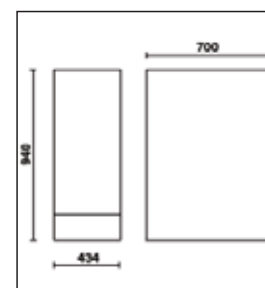

C55B/GE

gamba universale con prese elettriche per banco da lavoro arredo officina

- Presa Schuko+16+10A
- Presa EU Plug 10A
- Dotata di piedini regolabili in altezza
- Accesso frontale e laterale

30 kg

C55B/GE

€ 796,00

1

055000097

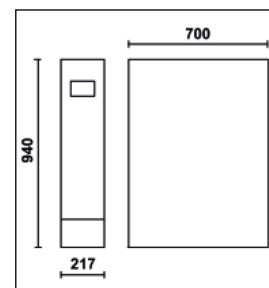

C55B/GAE

gamba universale con avvolgitore elettrico integrato per banco da lavoro arredo officina

- Avvolgitore automatico integrato con presa Schuko
- Lunghezza cavo: 15 m
- Con protezione termica
- Dotata di piedini regolabili in altezza
- Accesso frontale e laterale

35 kg

C55B/GAE

€ 1.096,00

1

055000094

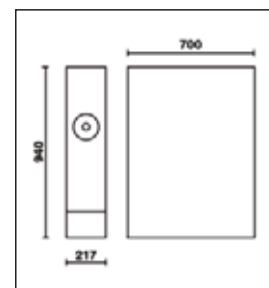

C55/PL-1,024

piano di lavoro da 1 metro per estensione banco

Piano di lavoro in lamiera verniciata 1024x700 mm rivestito da uno strato di PVC antiurto e antigraffio resistente agli idrocarburi

📦 21 kg

C55/PLO-1,024	€ 534,00	1	055000130
C55/PLG-1,024	€ 534,00	1	055000131



C55B PT/2

piano di lavoro da 2 metri per banco arredo officina

Piano di lavoro in lamiera verniciata 2050x700 mm rivestito da uno strato di PVC antiurto e antigraffio resistente agli idrocarburi

Fori per la collocazione di una morsa 1599F/150 - 1599GI/150 da ordinare separatamente

📦 43 kg

C55BO PT/2	€ 1.110,00	1	055000106
C55BG PT/2	€ 1.110,00	1	055000116

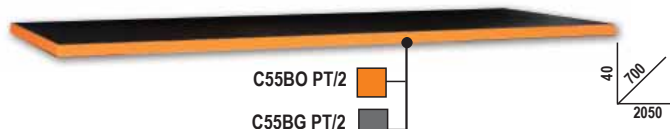

C55B PT/2,8

piano di lavoro da 2,8 metri per banco arredo officina

Piano di lavoro in lamiera verniciata 2850x700 mm rivestito da uno strato di PVC antiurto e antigraffio resistente agli idrocarburi

Fori per la collocazione di una morsa 1599F/150 - 1599GI/150 da ordinare separatamente

📦 61 kg

C55BO PT/2,8	€ 1.720,00	1	055000266
C55BG PT/2,8	€ 1.720,00	1	055000286



C55RB

rivestimento in PVC antiurto antigraffio resistente agli idrocarburi

per proteggere il piano di lavoro.

C55RB/2: per banco da 2 metri

C55RB/2,8: per banco da 2,8 metri

C55RB/0,7: per banco da 700x700mm

C55RB/1: per banco da 1 metro

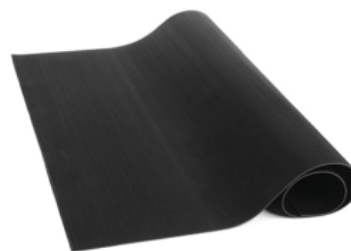

C55RB/2	€ 188,00	1	055000195
C55RB/2,8	€ 255,00	1	055000196
C55RB/0,7	€ 104,50	1	055000199
C55RB/1	€ 142,50	1	055000198

C55B/VS

staffa inferiore sostegno banchi

Misure 800x230x60 mm

📦 4 kg

C55B/VS	€ 142,50	1	055000095
---------	----------	---	-----------



C55C7

cassettiera mobile con 7 cassetti per arredo officina

7 cassetti da 588x367 mm, montati su guide telescopiche a sfera

- 4 ruote Ø 100 mm, 2 fisse e 2 girevoli (una con freno)
- Sistema di apertura in alluminio posizionato su tutta la lunghezza del cassetto
- Piano dei cassetti protetto da tappetini di gomma espansa
- Serratura centralizzata frontale
- Predisposizione per l'inserimento dei termoformati

79 kg



h	max
70 mm	30 kg
245 mm	40 kg

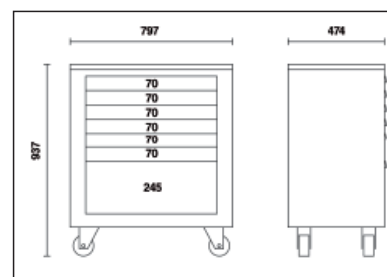
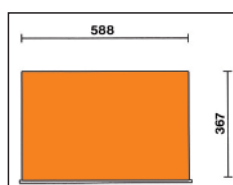

C55C7

€ 2.225,00 1 055000201

Beta

C55C8

modulo cassetiera mobile con 8 cassetti per arredo officina

8 cassetti da 588x367 mm, montati su guide telescopiche a sfera

- 4 ruote Ø 100 mm, 2 fisse e 2 girevoli (una con freno)
- Sistema di apertura in alluminio posizionato su tutta la lunghezza del cassetto
- Piano dei cassetti protetto da tappetini di gomma espansa
- Serratura centralizzata frontale
- Predisposizione per l'inserimento dei termoformati

81 kg



h	max
70 mm	30 kg
175 mm	40 kg

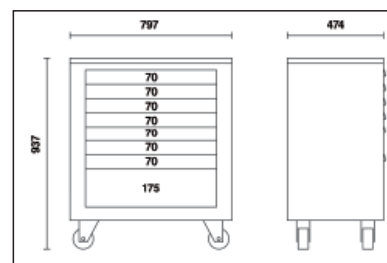
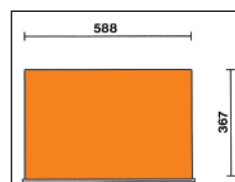

C55C8

€ 2.265,00 1 055000206

C55M2

modulo fisso con 2 cassetti per arredo officina

2 cassetti da 588x367mm, montati su guide telescopiche a sfera

- Sistema di apertura in alluminio posizionato su tutta la lunghezza del cassetto
- Piano dei cassetti protetto da tappetini di gomma espansa
- Serratura centralizzata frontale

66 kg



h	max
280 mm	40 kg
385 mm	40 kg

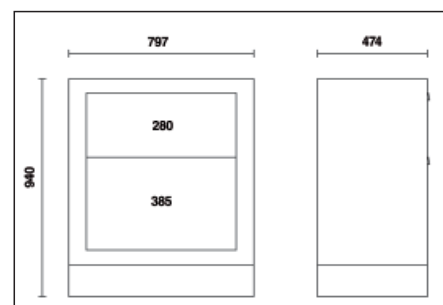
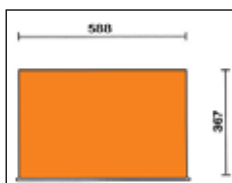

C55M2

€ 1.890,00 1 055000202

C55M4

modulo fisso con 4 cassetti per arredo officina

4 cassetti da 588x367 mm, montati su guide telescopiche a sfera

- Sistema di apertura in alluminio posizionato su tutta la lunghezza del cassetto
- Piano dei cassetti protetto da tappetini di gomma espansa
- Serratura centralizzata frontale

75 kg



h	max
140 mm	30 kg
245 mm	40 kg

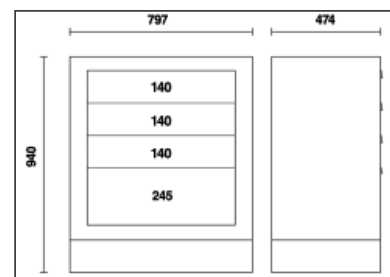

C55M4

€ 1.985,00 1 055000212

C55M7

modulo fisso con 7 cassetti per arredo officina

7 cassetti da 588x367 mm, montati su guide telescopiche a sfera

- Sistema di apertura in alluminio posizionato su tutta la lunghezza del cassetto
- Piano dei cassetti protetto da tappetini di gomma espansa
- Serratura centralizzata frontale
- Predisposizione per l'inserimento dei termoformati

78 kg



h	max
70 mm	30 kg
245 mm	40 kg

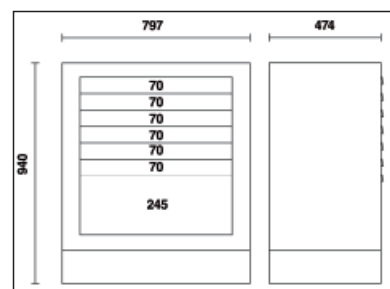
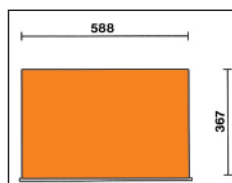

C55M7

€ 2.105,00 1 055000203

C55M8

modulo fisso con 8 cassetti per arredo officina

- 8 cassetti da 588x367 mm, montati su guide telescopiche a sfera
- Sistema di apertura in alluminio posizionato su tutta la lunghezza del cassetto
- Piano dei cassetti protetto da tappetini digomma espansa
- Serratura centralizzata frontale
- Predisposizione per l'inserimento dei termoformati

📦 78,9 kg



h	max
70 mm	30 kg
175 mm	40 kg

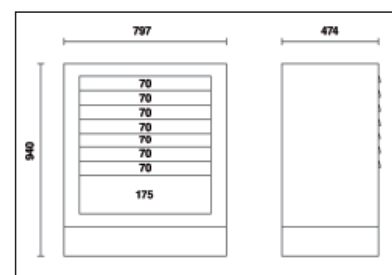
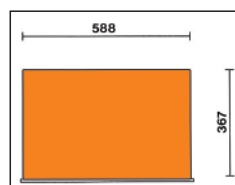

C55M8

€ 2.145,00 1 055000207

C55CS

modulo fisso per rifiuti differenziati per arredo officina

- Vano spazzatura estraibile 588x465 mm montato su guide telescopiche a sfera
- 2 capienti contenitori interni estraibili per differenziare i rifiuti

📦 62 kg

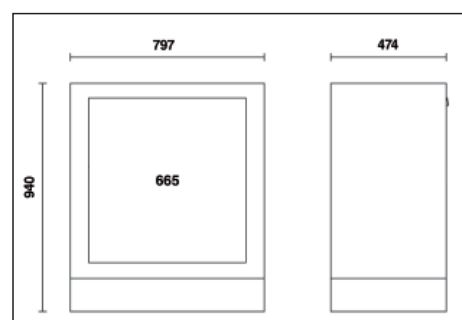

C55 CS

€ 1.915,00 1 055000208

C55MA

modulo fisso con due antine per arredo officina

- Sistema di apertura push & pull a pressione
- Dotato di serratura
- Ripiano interno regolabile in altezza

📦 75 kg

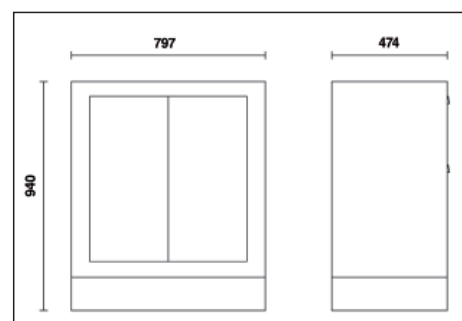

C55MA

€ 1.635,00 1 055000205

C55MDO

Modulo fisso di distribuzione olio per arredo officina

- 2 arrotolatori con tubo flessibile da 7m - 1/2" inclusi
- Completo di 2 pistole con conta litri digitali dotate di salvagoccia automatico.
 - portata max: 30 l/min
 - viscosità: 8÷2000 mPas

📦 94 kg

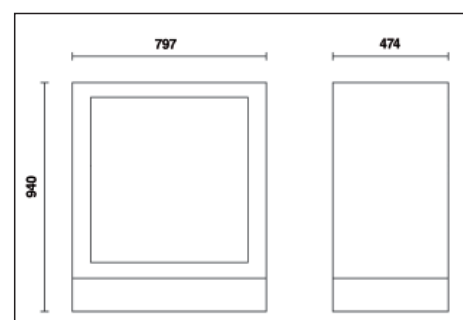

C55MDO

€ 3.320,00 1 055000210

C55MS

modulo fisso di servizio per arredo officina

- Cestino portarifiuti integrato
- Vano portacarta per rotoli preforati
- Cassettone portaoggetti 305x270 mm

📦 75 kg



C55MS

€ 1.725,00



055000204

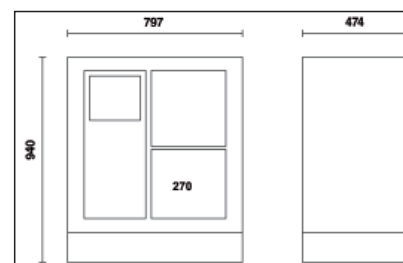

C55T3

carrello

- 3 ripiani ricoperti in gomma millerighe antiscivolo
- Maniglia ergonomica
- Doppia possibilità di fissaggio del ripiano centrale
- Quattro ruote girevoli Ø 100 mm (due con freno)
- Capacità di carico statico: 200 kg. (distribuita sui 3 ripiani)

📦 21 kg

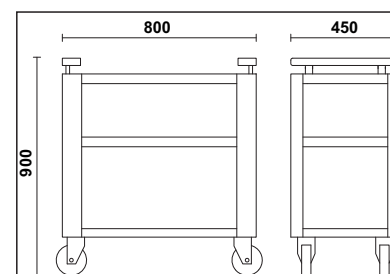

C55T3

€ 390,00



055000219

C55P/MCD

montanti centrali intermedi doppi

10 kg

C55P/MCD € 164,50 1 055000257



C55P/2MDX-SX

coppia di montanti DX-SX pareti

10 kg

C55P/2MDX-SX € 300,00 1 055000253



C55PM

pensile per arredo officina da 1 metro

• Misure 1024x400x300 mm dotato di molle a gas per facilitare l'apertura e la chiusura dell'anta

24 kg

C55PM € 1.096,00 1 055000302

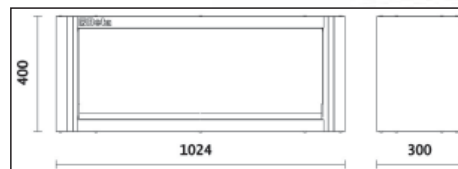

C55PFA-1,0

pannello forato autoportante da 1 metro per arredo officina

Pannello forato in acciaio 1024x1020x25 mm per il sostegno degli utensili

11 kg

C55PFA-1,0 € 368,00 1 055000316

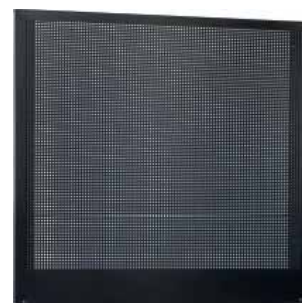

C55/PF

pannello forato sotto pensile per arredo officina da 1 metro

• Pannello forato 1024x620x25 mm per il sostegno degli utensili, da sovrapporre a C55PT1,0x0,6

6 kg

C55/PF € 253,00 1 055000307

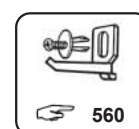

C55PT1,0X0,6

pannello sotto pensile da 1 metro

Misure 1024x620x25 mm

8 kg

C55PT1,0X0,6 € 202,00 1 055000314



C55PTE-1,0

pannello sotto pensile da 1 metro

Misure 1024x620x25 mm

Con predisposizione per 2 prese elettriche (non incluse)

8 kg

C55PTE-1,0 € 240,00 1 055000319



C55/2PM

parete con 2 pensili per arredo officina

- 2 pensili 1024x400x300 mm dotati di molle a gas per facilitare l'apertura e la chiusura delle ante.
- 2 pannelli a muro 1024x620 mm con predisposizione per alloggiare pannelli forati portautensili C55/PF (da ordinare separatamente)
- Fornita con struttura portante
- Abbinabile al banco di lavoro da 2 metri.

80 kg

C55/2PM € 3.060,00 1 055000301

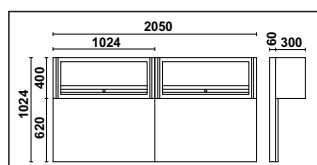
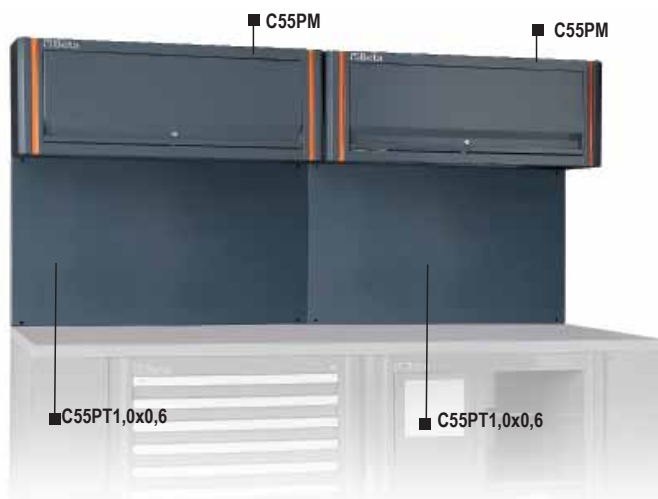

 **Beta**

C55PFA-0,8

pannello forato autoportante da 0,8 metri per arredo officina

Pannello forato in acciaio 800x1020x25 mm per il sostegno degli utensili

10 kg

C55PFA-0,8 € 339,00 1 055000315



C55PM/M0,8

Pensile 0,8 metri per arredo officina

Misure 800x400x300 mm dotato di molle a gas per facilitare l'apertura e la chiusura dell'anta

19 kg

C55PM/M0,8 € 1.052,00 1 055000312

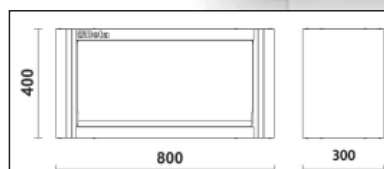

C55PTE-0,8

pannello sotto pensile da 0,8 metri

Misure 800x620x25 mm
Con predisposizione per 1 presa elettrica (non inclusa)

6 kg

C55PTE-0,8 € 217,50 1 055000318



C55PT0,8X0,6

pannello sotto pensile da 0,8 metri

Misure 800x620x25 mm

7,8 kg

C55PT0,8X0,6 € 188,00 1 055000313



C55/1PF

pannello forato portautensili per arredo officina

• Pannello forato 800x620x25 mm per il sostegno degli utensili

5 kg

C55/1PF € 157,50 1 055000309

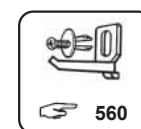
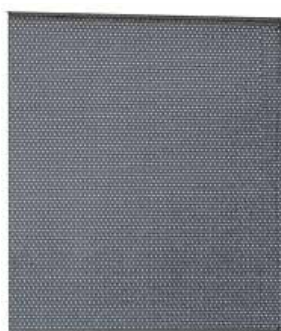

C55PS

parete portautensili con tapparella per arredo officina

- Tapparella in alluminio, manovrabile verticalmente, con serratura
- Pannello forato amovibile per il sostegno degli utensili
- Fornita con struttura portante
- Kit di 50 ganci GPS incluso
- Abbinabile al banco di lavoro da 2 metri.

88 kg

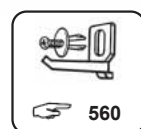
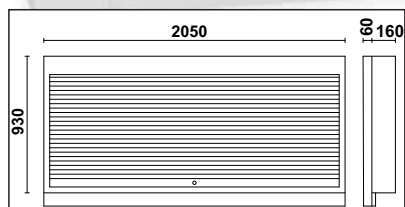

C55PS-O	€ 2.170,00	1	055000250
C55PS-G	€ 2.170,00	1	055000255

C55PSE

parete portautensili con tapparella e predisposizione per 2 prese elettriche

- Tapparella in alluminio, manovrabile verticalmente, con serratura
- Pannello forato amovibile per il sostegno degli utensili
- Fornita con struttura portante
- Kit di 50 ganci GPS incluso
- Con predisposizione per prese elettriche (non incluse)
- Abbinabile al banco di lavoro da 2 metri.

88 kg

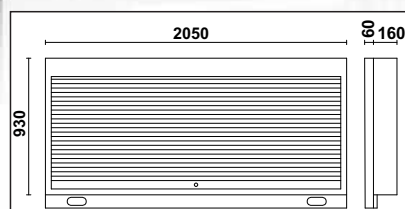

C55PSE-O	€ 2.190,00	1	055000258
C55PSE-G	€ 2.190,00	1	055000260

C55AE

profilo 2 metri con predisposizione elettrica

Misure 2050x25x90mm
Con predisposizione per 2 prese elettriche

1,5 kg

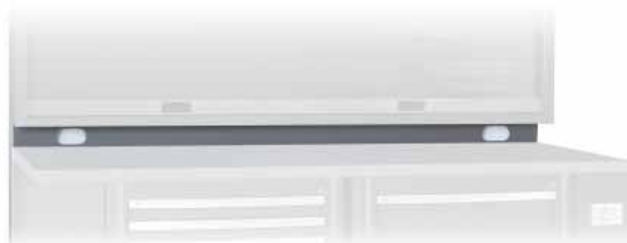

C55AE	€ 202,00	1	055000325
-------	----------	---	-----------

C55AC

angolo completo autoportante

Piano di lavoro da 700x700 mm con gambe
2 pareti superiori porta utensili complete di 2 mensole per fissaggio 670x160 mm

66 kg

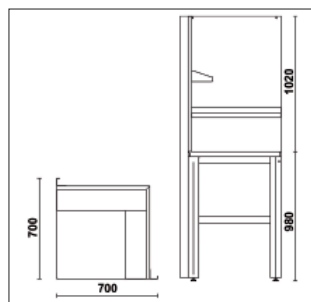

C55AC-O

C55AC-G

C55AC-O	€ 2.510,00	1	055000360
C55AC-G	€ 2.510,00	1	055000380

C55KAI

elemento angolare 700x700 con gambe

• Piano di lavoro in lamiera verniciata 700x700 mm rivestito da uno strato di PVC antiurto e antigraffio resistente agli idrocarburi

32 kg

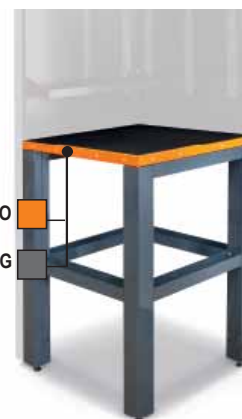

C55KAI-O

C55KAI-G

C55KAI-O	€ 1.440,00	1	055000365
C55KAI-G	€ 1.440,00	1	055000385

C55KAS

angolo superiore con pareti porta utensili

• 2 Pareti forate 700x1020x25 mm
• 2 Mensole per fissaggio 670x160 mm

24 kg



C55KAS	€ 1.064,00	1	055000370
--------	------------	---	-----------

C55MP

Mensole in acciaio per pareti angolo

Misure 670x160x80 mm



C55MP	€ 150,00	1	055000374
-------	----------	---	-----------



C55B/1

estensione da 1 metro per arredo officina con modulo fisso C55M7

Piano di lavoro 1024x700 mm rivestito da uno strato di PVC antiurto e antigraffio resistente agli idrocarburi

- Gamba universale dotata di piedini regolabili in altezza
- 1 modulo fisso: 7 cassetti da 588x367 mm, montati su guide telescopiche a sfera
- Sistema di apertura in alluminio posizionato su tutta la lunghezza del cassetto
- Piano dei cassetti protetto da tappetini di gomma espansa
- Serratura centralizzata frontale

127 kg



C55BO/1

C55BG/1



h	max
70 mm	30 kg
245 mm	40 kg

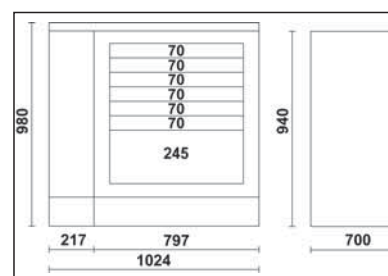
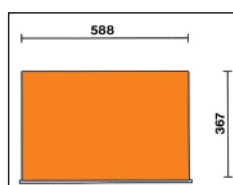

C55BO/1	€ 3.290,00	1	055000090
C55BG/1	€ 3.290,00	1	055000091

Beta

C55A1

armadio in lamiera a un'anta per arredo officina

- 3 ripiani amovibili regolabili in altezza
- Pratica barra appendiabiti richiudibile, posizionata sotto il primo ripiano
- Dotato di serratura
- Misure utili interne: 1798x497x403 mm

50 kg

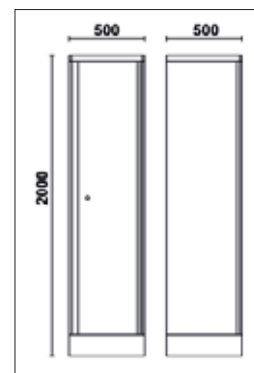

C55A1

€ 796,00 1 055000411

C55A1/R42

ripiano interno per armadio C55A1/C55AT1

2,4 kg



C55A1/R42

497x403 mm

€ 34,50 1 055000461

C55 A1/RB42

ripiano interno per armadio C55A1/C55AT1 con barra appendiabiti

2,5 kg



C55 A1/RB42

497x403 mm

€ 43,00 1 055000463

 **Beta**

C55A2

armadio in lamiera a due ante per arredo officina

- 3 ripiani amovibili regolabili in altezza
- Dotato di serratura
- Misure utili interne: 1798x797x403 mm

📦 72 kg

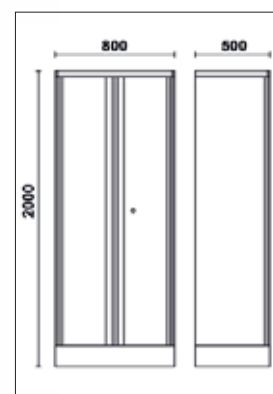

C55A2

€ 1.066,00 1 055000412

C55A2/R70

ripiano interno per armadio C55A2/C55AT2

📦 3,5 kg



C55A2/R70

797x403 mm

€ 55,50 1 055000462



C55AT1

armadio in lamiera con anta trasparente in policarbonato per arredo officina

- 3 ripiani amovibili regolabili in altezza
- Dotato di serratura
- Misure utili interne: 1798x497x403 mm

41 kg

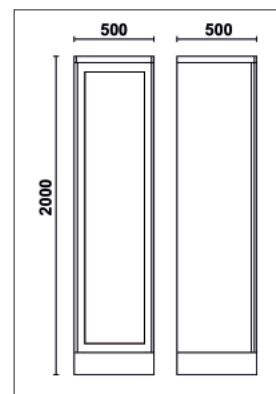

C55AT1 € 886,00 1 055000421

C55AT2

armadio in lamiera con due ante trasparenti in policarbonato per arredo officina

- 3 ripiani amovibili regolabili in altezza
- Dotato di serratura
- Misure utili interne: 1798x797x403 mm

56 kg

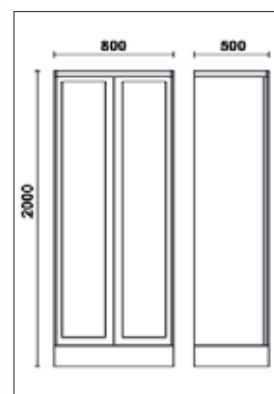

C55AT2 € 1.200,00 1 055000422

C55STR

nastro adesivo colorato 25 m

permette di personalizzare il colore degli inserti verticali dell'arredo officina C55



RAL2011
RAL3000
RAL6029
RAL9016
RAL1023
RAL5015
RAL1035
RAL9006

		€		
C55STR-O/2011		81,00	1	055000901
C55STR-R/3000		81,00	1	055000903
C55STR-V/6029		81,00	1	055000906
C55STR-W/9016		81,00	1	055000907
C55STR-Y/1023		81,00	1	055000905
C55STR-B/5015		81,00	1	055000904
C55STR-GO/1035		81,00	1	055000909
C55STR-S/9006		81,00	1	055000902





ARREDO OFFICINA

Beta
RSC50

Beta continua ad investire nella propria produzione Made in Italy ed è orgogliosa di presentare

la nuova linea di arredo RSC50

Grazie all'esperienza maturata con le due linee d'arredo esistenti RSC55 e C45PRO, che ha permesso di ascoltare e comprendere a pieno le esigenze degli utilizzatori professionisti, il progetto della nuova linea RSC50 si basa sui seguenti concetti cardine:

Qualità

La nostra rinomata cura nella scelta dei materiali impiegati, la meticolosa attenzione al dettaglio e non ultimo il design accattivante rendono l'RSC50 unico nel suo genere.



Flessibilità

Ogni combinazione d'arredo può essere ampliata o modificata in qualsiasi momento in base alle proprie esigenze.

Compatibilità

I cassetti, grazie alla dimensione standard Beta (588x367 mm), possono contenere i numerosi moduli portautensili, disponibili in versione morbida in EVA oppure rigida in ABS.



Efficienza

Montaggio semplice e rapido, grazie all'ottimizzazione produttiva dei vari componenti della gamma.

Funzionalità e robustezza

Il piano di lavoro in lamiera verniciata, con rivestimento protettivo in PVC, è profondo 63 cm per garantire di avere una superficie di lavoro ampia, comoda e funzionale. La predisposizione al montaggio di una morsa lo rende adatto anche per gli impieghi più gravosi. avere una superficie di lavoro ampia, comoda e funzionale. La predisposizione al montaggio di una morsa lo rende adatto anche per gli impieghi più gravosi.



MADE IN ITALY



Configura on-line la tua officina
Vai su **www.beta-tools.com/rsc50**

Il nuovo arredo RSC50 offre combinazioni precomposte studiate da Beta per il professionista, oppure consente di progettare in completa autonomia la propria postazione di lavoro scegliendo tra i numerosi moduli sottobanco, sovrastrutture e complementi d'arredo.

La personalizzazione del colore delle maniglie dei cassetti e l'illuminazione applicabile sotto i piani di lavoro e ai pensili rendono unico il nuovo arredamento RSC50, la scelta ideale per chi desidera lavorare in un ambiente funzionale ed efficiente.



RSC50 I

combinazione arredo officina RSC50

Combinazione composta da:

- 1 Piano di lavoro da 2.240x630 mm (RSC50 PG/3-2,2MT)
- 1 Piano di lavoro da 1.495x630 mm (RSC50 PG/2-1,5MT)
- 1 Modulo fisso con 7 cassetti (RSC50 M7)
- 1 Cassettiera mobile con 7 cassetti (RSC50 C7)
- 1 Modulo fisso di servizio con 2 cassetti (RSC50 MS-2C)
- 1 Angolo completo autoportante (RSC50 AC-G)
- 1 Modulo fisso con 5 cassetti (RSC50 M5)
- 1 Modulo fisso con 2 antine (RSC50 MA)
- 5 pensili a muro (RSC50 PM)
- 5 pannelli forati portautensili superiori (RSC50 PFS)
- 5 pannelli forati portautensili inferiori (RSC50 PFI)
- 5 coppie montanti DX-SX (RSC50 P/2MDX-SX)
- 2 Armadi ad 1 anta (RSC50 A1)

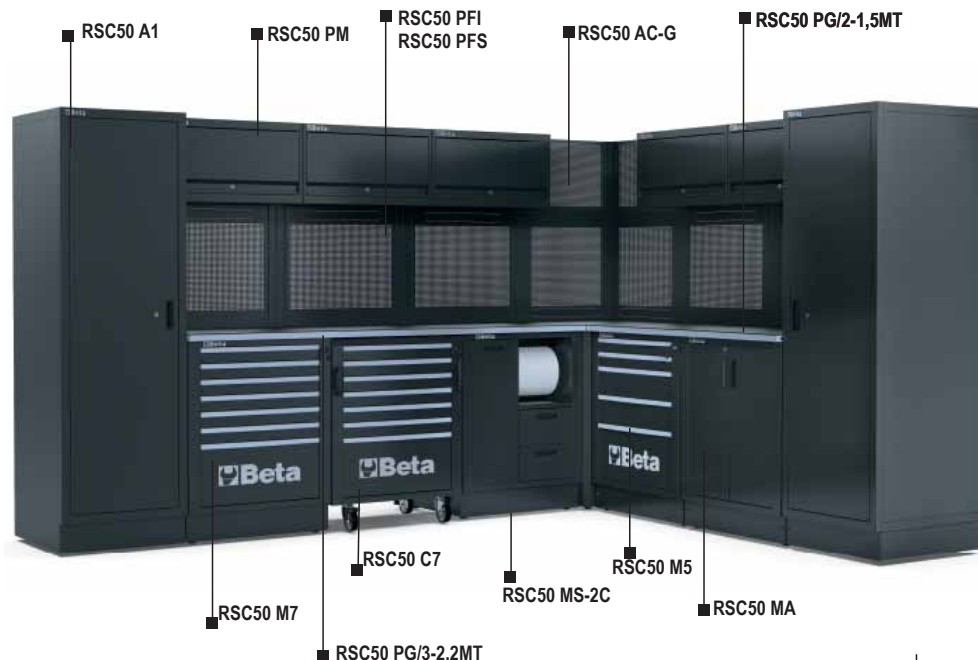

625 kg

RSC50 I € 18.810,00 1 050001045

RSC50 L

combinazione arredo officina RSC50

Combinazione composta da:

- 1 Piano di lavoro da 2.240x630 mm (RSC50 PG/3-2,2MT)
- 1 Piano di lavoro da 750x630 mm (RSC50 PG/1-0,7MT)
- 1 Modulo fisso di servizio (RSC50 MS-2AVV) con avvolgitubo aria compressa art. 1900S 8x10 e avvolgicavo elettrico art. 1844 15-H05/SCK in dotazione
- 1 Cassettiera mobile con 7 cassetti (RSC50 C7)
- 1 Modulo fisso con 7 cassetti (RSC50 M7)
- 1 Angolo completo autoportante (RSC50 AC-G)
- 1 Modulo fisso con 2 antine (RSC50 MA)
- 1 Parete portautensili con tapparella in alluminio e struttura portante (RSC50 PS)
- 2 pensili a muro (RSC50 PM)
- 2 pannelli forati portautensili superiori (RSC50 PFS)
- 2 pannelli forati portautensili inferiori (RSC50 PFI)
- 2 coppie montanti DX-SX (RSC50 P/2MDX-SX)
- 2 Armadi ad 1 anta (RSC50 A1)

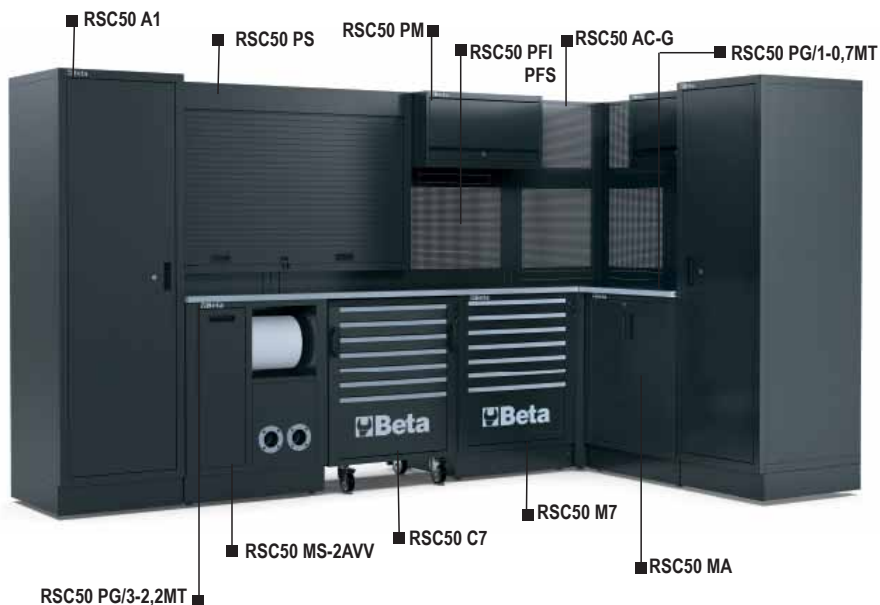

541 kg

RSC50 L € 16.440,00 1 050001050

RSC50

combinazione completa arredo officina RSC50

Combinazione completa composta da:

- 1 Armadio ad 1 anta (RSC50 A1)
- 1 Piano di lavoro da 750x630 mm (RSC50 PG/1-0,7MT)
- 1 Piano di lavoro da 2.240x630 mm (RSC50 PG/3-2,2MT)
- 1 Cassettiera mobile con 7 cassetti (RSC50 C7)
- 1 Modulo fisso con 4 cassetti (RSC50 M4)
- 1 Modulo fisso con 7 cassetti (RSC50 M7)
- 1 Modulo fisso di servizio (RSC50 MS-AVV) con avvolgitubo aria compressa art. 1900S 8x10 in dotazione
- 1 Parete portautensili con tapparella in alluminio e struttura portante (RSC50 PS)
- 2 pensili a muro (RSC50 PM)
- 2 pannelli forati portautensili superiori (RSC50 PFS)
- 2 pannelli forati portautensili inferiori (RSC50 PFI)
- 2 coppie montanti DX-SX (RSC50 P/2MDX-SX)
- 1 Armadio a 2 ante (RSC50 A2)



534 kg

RSC50 € 14.930,00 1 050001000

RSC50 H

combinazione arredo officina RSC50

Combinazione composta da:

- 1 Piano di lavoro da 2.240x630 mm (RSC50 PG/3-2,2MT)
- 1 Modulo fisso di servizio con 2 cassetti (RSC50 MS-2C)
- 1 Cassettiera mobile con 7 cassetti (RSC50 C7)
- 1 Modulo fisso con 7 cassetti (RSC50 M7)
- 1 Modulo fisso con lavandino integrato (RSC50 ML)
- 4 pensili a muro (RSC50 PM)
- 4 pannelli forati portautensili superiori (RSC50 PFS)
- 4 pannelli forati portautensili inferiori (RSC50 PFI)
- 4 coppie montanti DX-SX (RSC50 P/2MDX-SX)
- 1 Armadio ad 1 anta (RSC50 A1)

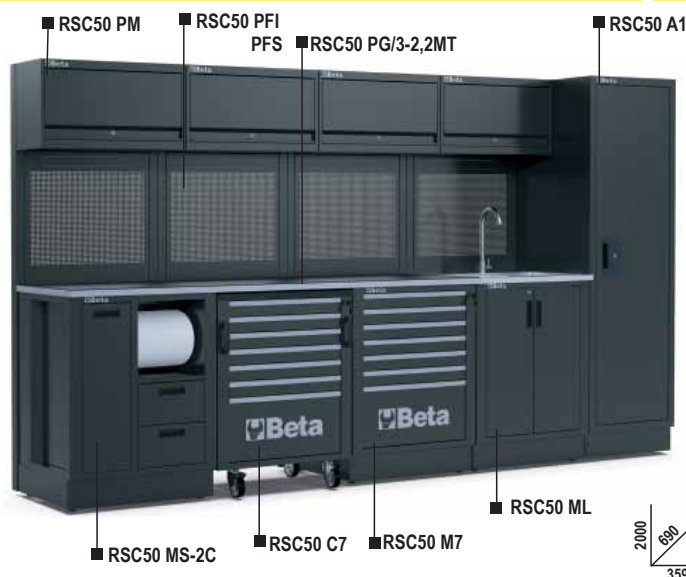

417 kg

RSC50 H € 13.030,00 1 050001040

RSC50 G

combinazione arredo officina RSC50

Combinazione composta da:

- 1 Piano di lavoro da 2.240x630 mm (RSC50 PG/3-2,2MT)
- 1 Modulo fisso di servizio (RSC50 MS-2AVV) con avvolgitubo aria compressa art. 1900S 8x10 e avvolgicavo elettrico art. 1844 15-H05/SCK in dotazione
- 1 Cassettiera mobile con 7 cassetti (RSC50 C7)
- 1 Modulo fisso con 4 cassetti (RSC50 M4)
- 3 pensili a muro (RSC50 PM)
- 3 pannelli forati portautensili superiori (RSC50 PFS)
- 3 pannelli forati portautensili inferiori (RSC50 PFI)
- 3 coppie montanti DX-SX (RSC50 P/2MDX-SX)
- 1 Armadio a 2 ante (RSC50 A2)



356 kg

RSC50 G € 10.980,00 1 050001035

RSC50 F

combinazione arredo officina RSC50

Combinazione composta da:

- 1 Piano di lavoro da 2.240x630 mm (RSC50 PG/3-2,2MT)
- 1 Modulo fisso con 7 cassetti (RSC50 M7)
- 1 Cassettiera mobile con 7 cassetti (RSC50 C7)
- 1 Modulo fisso di servizio con 2 cassetti (RSC50 MS-2C)
- 3 pensili a muro (RSC50 PM)
- 3 pannelli forati portautensili superiori (RSC50 PFS)
- 3 pannelli forati portautensili inferiori (RSC50 PFI)
- 3 coppie montanti DX-SX (RSC50 P/2MDX-SX)
- 1 Armadio a 2 ante (RSC50 A2)

361 kg

RSC50 F

10.760,00



1



050001030



RSC50 E

combinazione arredo officina RSC50

Combinazione composta da:

- 1 Piano di lavoro da 2.240x630 mm (RSC50 PG/3-2,2MT)
- 1 Modulo fisso di servizio con 2 cassetti (RSC50 MS-2C)
- 1 Modulo fisso con 7 cassetti (RSC50 M7)
- 1 Modulo fisso con 2 antine (RSC50 MA)
- 3 pensili a muro (RSC50 PM)
- 3 pannelli forati portautensili superiori (RSC50 PFS)
- 3 pannelli forati portautensili inferiori (RSC50 PFI)
- 3 coppie montanti DX-SX (RSC50 P/2MDX-SX)

266 kg

RSC50 E

8.800,00



1



050001025



RSC50 D

combinazione arredo officina RSC50

Combinazione composta da:

- 1 Piano di lavoro da 1.495x630 mm (RSC50 PG/2-1,5MT)
- 1 Modulo fisso con 5 cassetti (RSC50 M5)
- 1 Modulo fisso con 2 antine (RSC50 MA)
- 2 pensili a muro (RSC50 PM)
- 2 pannelli forati portautensili superiori (RSC50 PFS)
- 2 pannelli forati portautensili inferiori (RSC50 PFI)
- 2 coppie montanti DX-SX (RSC50 P/2MDX-SX)
- 1 Armadio ad 1 anta (RSC50 A1)

230 kg

RSC50 D

6.740,00



1



050001020

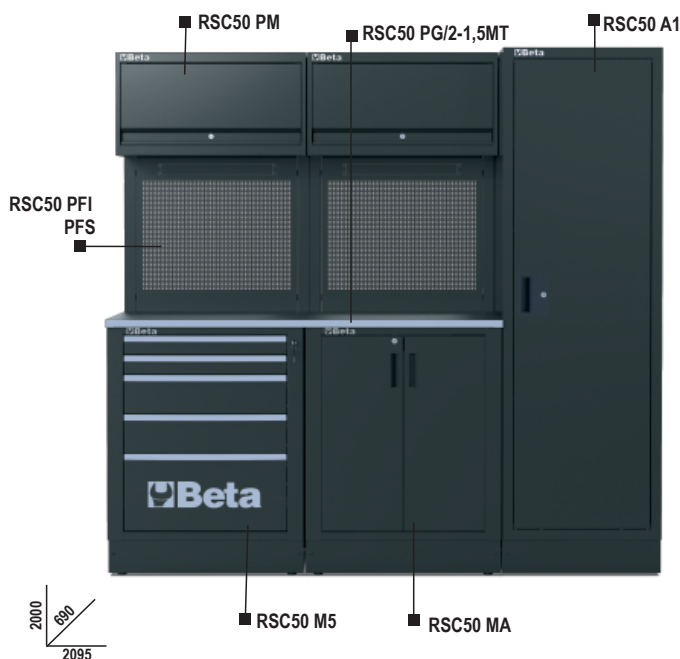

RSC50 C

combinazione arredo officina RSC50

Combinazione composta da:

- 1 Piano di lavoro da 1.495x630 mm (RSC50 PG/2-1,5MT)
- 1 Modulo fisso di servizio con 2 cassette (RSC50 MS-2C)
- 1 Modulo fisso con 7 cassette (RSC50 M7)
- 2 pensili a muro (RSC50 PM)
- 2 pannelli forati portautensili superiori (RSC50 PFS)
- 2 pannelli forati portautensili inferiori (RSC50 PFI)
- 2 coppie montanti DX-SX (RSC50 P/2MDX-SX)
- 1 Armadio ad 1 anta (RSC50 A1)

258 kg

RSC50 C

€ 7.100,00 1 050001015

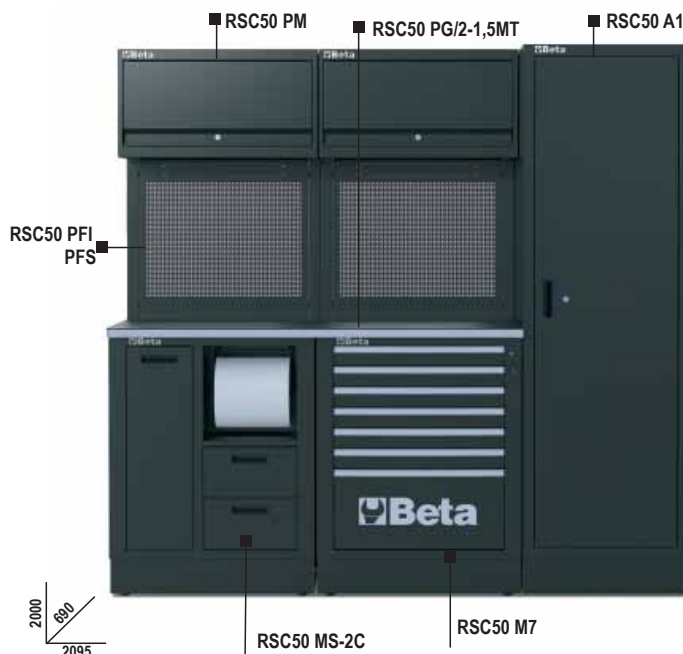

RSC50 B

combinazione arredo officina RSC50

Combinazione composta da:

- 1 Piano di lavoro da 1.495x630 mm (RSC50 PG/2-1,5MT)
- 1 Modulo fisso con 2 antine (RSC50 MA)
- 1 Modulo fisso con 7 cassette (RSC50 M7)
- 1 Parete portautensili con taparella in alluminio e struttura (RSC50 PS)

188 kg

RSC50 B

€ 6.140,00 1 050001010

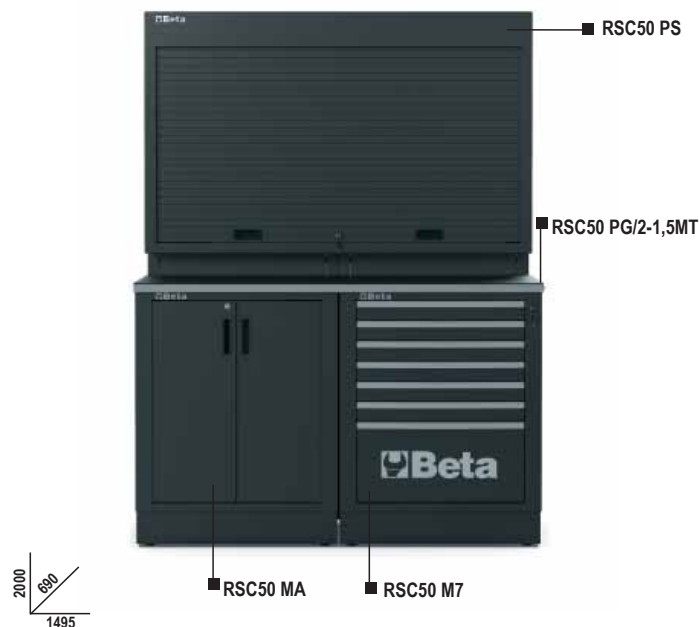

RSC50 A

combinazione arredo officina RSC50

Combinazione composta da:

- 1 Piano di lavoro da 1.495x630 mm (RSC50 PG/2-1,5MT)
- 1 Modulo fisso con 7 cassette (RSC50 M7)
- 1 Modulo fisso di servizio con 2 cassette (RSC50 MS-2C)
- 2 pensili a muro (RSC50 PM)
- 2 pannelli forati portautensili superiori (RSC50 PFS)
- 2 pannelli forati portautensili inferiori (RSC50 PFI)
- 2 coppie montanti DX-SX (RSC50 P/2MDX-SX)

192 kg

RSC50 A

€ 6.220,00 1 050001005

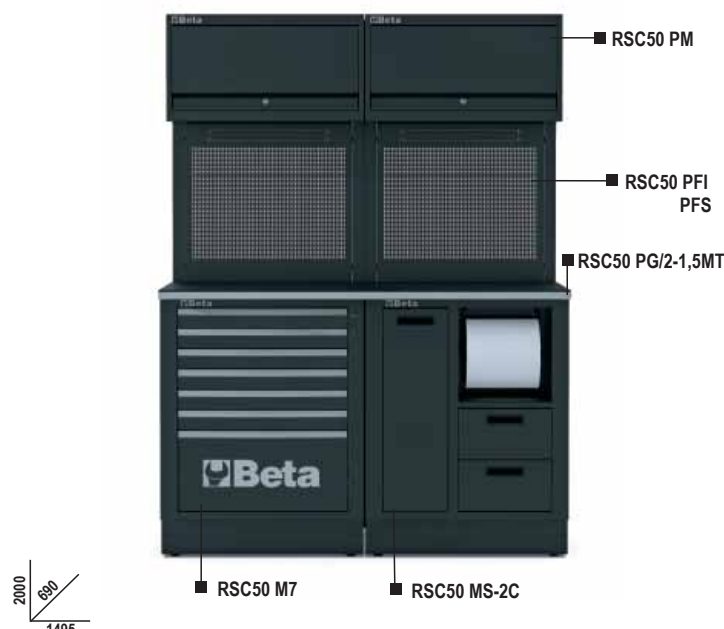

RSC50 P/1-0,7MT

piano di lavoro da 0,75m per arredo officina RSC50

Piano di lavoro in lamiera verniciata 750x630 mm, rivestito da uno strato di PVC antiurto e antigraffio resistente agli idrocarburi.
Fornito completo di due tamponature laterali esterne.

Fori su entrambi i lati per la collocazione di una morsa 1599P/125 (da ordinare separatamente).

Predisposto per l'applicazione dei profili in alluminio con strip LED art. 5000 RSC50/PLED o 5000 RSC50/PLED-ST (da ordinare separatamente), per illuminare i moduli sottobanco.

📦 12,4 kg

RSC50 PG/1-0,7MT	508,00	1	050001107
RSC50 PA/1-0,7MT	508,00	1	050001108



RSC50 P/2-1,5MT

piano di lavoro da 1,5m per arredo officina RSC50

Piano di lavoro in lamiera verniciata 1.495x630 mm, rivestito da uno strato di PVC antiurto e antigraffio resistente agli idrocarburi.
Fornito completo di due tamponature laterali.

Fori su entrambi i lati per la collocazione di una morsa 1599P/125 (da ordinare separatamente).

Predisposto per l'applicazione dei profili in alluminio con strip LED art. 5000 RSC50/PLED o 5000 RSC50/PLED-ST (da ordinare separatamente), per illuminare i moduli sottobanco.

📦 24,5 kg

RSC50 PG/2-1,4MT	712,00	1	050001114
RSC50 PA/2-1,4MT	712,00	1	050001115



RSC50 P/3-2,2MT

piano di lavoro da 2,2m per arredo officina RSC50

Piano di lavoro in lamiera verniciata 2.240x630 mm, rivestito da uno strato di PVC antiurto e antigraffio resistente agli idrocarburi.
Fornito completo di due tamponature laterali esterne.

Fori su entrambi i lati per la collocazione di una morsa 1599P/125 (da ordinare separatamente).

Predisposto per l'applicazione dei profili in alluminio con strip LED art. 5000 RSC50/PLED o 5000 RSC50/PLED-ST (da ordinare separatamente), per illuminare i moduli sottobanco.

📦 36,5 kg

RSC50 PG/3-2,2MT	866,00	1	050001122
RSC50 PA/3-2,2MT	866,00	1	050001123

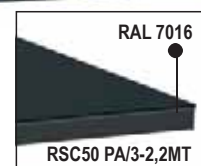

RSC50 RB

rivestimento in PVC antiurto antigraffio resistente agli idrocarburi

Indispensabile per proteggere il piano di lavoro.

RSC50 RB/0,63: per piano angolare da 630x630 mm

RSC50 RB/0,75: per piano da 750 mm

RSC50 RB/1,5: per piano da 1.495 mm

RSC50 RB/2,2: per piano da 2.240 mm

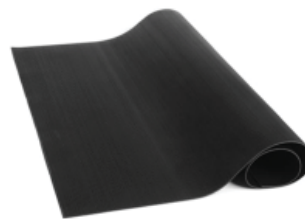

RSC50 RB/0,63	€ 55,00	1	050001140
RSC50 RB/0,75	€ 66,00	1	050001141
RSC50 RB/1,5	€ 132,00	1	050001142
RSC50 RB/2,2	€ 198,00	1	050001143

RSC50 C5

cassettiera mobile con 5 cassetti per arredo officina RSC50

- 5 cassetti da 588x367 mm, montati su guide telescopiche a sfera
- 4 ruote girevoli Ø 100 mm (2 con freno)
- Piano dei cassetti protetto da tappetini di gomma espansa
- Serratura centralizzata frontale
- Maniglie integrate nella struttura per una facile movimentazione
- Possibilità di inserire in ogni cassetto fino a 4 vassoi morbidi in EVA o termoformati rigidi in ABS

51,4 kg

h	max
70 mm	25 kg
140 mm	30 kg
280 mm	35 kg

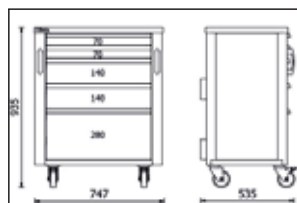
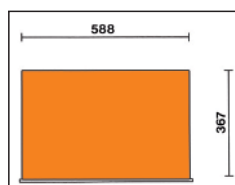

800 kg



RSC50 C5	€ 1.810,00	1	050001205
----------	------------	---	-----------

RSC50 C7

cassettiera mobile con 7 cassetti per arredo officina RSC50

- 7 cassetti da 588x367 mm, montati su guide telescopiche a sfera
- 4 ruote girevoli Ø 100 mm (2 con freno)
- Piano dei cassetti protetto da tappetini di gomma espansa
- Serratura centralizzata frontale
- Maniglie integrate nella struttura per una facile movimentazione
- Possibilità di inserire in ogni cassetto fino a 4 vassoi morbidi in EVA o termoformati rigidi in ABS

56,3 kg

h	max
70 mm	25 kg
280 mm	35 kg

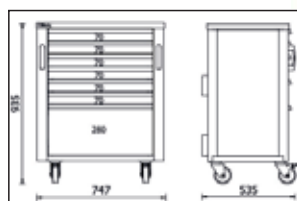
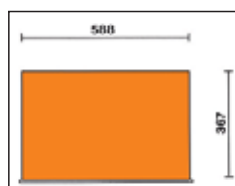

800 kg



RSC50 C7	€ 1.890,00	1	050001207
----------	------------	---	-----------

RSC50 C8

cassettiera mobile con 8 cassetti per arredo officina RSC50

- 8 cassetti da 588x367 mm, montati su guide telescopiche a sfera
- 4 ruote girevoli Ø 100 mm (2 con freno)
- Piano dei cassetti protetto da tappetini di gomma espansa
- Serratura centralizzata frontale
- Maniglie integrate nella struttura per una facile movimentazione • Possibilità di inserire in ogni cassetto fino a 4 vassoi morbidi in EVA o termoformati rigidi in ABS

📦 59 kg

h	max
70 mm	25 kg
140 mm	30 kg

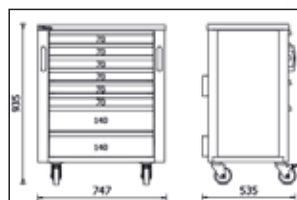
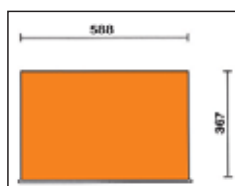

RSC50 C8 € 1.930,00 1 050001208

RSC50 M4

modulo fisso con 4 cassetti per arredo officina RSC50

- 4 cassetti da 588x367 mm, montati su guide telescopiche a sfera
- Piano dei cassetti protetto da tappetini di gomma espansa
- Serratura centralizzata frontale
- Dotato di piedini regolabili in altezza
- Possibilità di inserire in ogni cassetto fino a 4 vassoi morbidi in EVA o termoformati rigidi in ABS

📦 44,5 kg

h	max
140 mm	30 kg
280 mm	35 kg

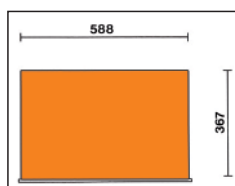

RSC50 M4 € 1.535,00 1 050001224

RSC50 M5

modulo fisso con 5 cassetti per arredo officina RSC50

- 5 cassetti da 588x367 mm, montati su guide telescopiche a sfera
- Piano dei cassetti protetto da tappetini di gomma espansa
- Serratura centralizzata frontale
- Dotato di piedini regolabili in altezza
- Possibilità di inserire in ogni cassetto fino a 4 vassoi morbidi in EVA o termoformati rigidi in ABS

📦 47 kg

h	max
70 mm	25 kg
140 mm	30 kg
280 mm	35 kg

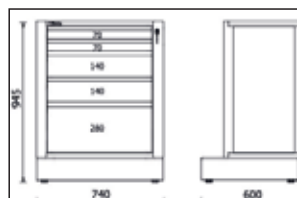
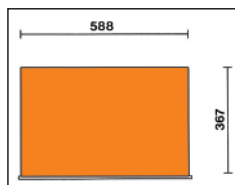

RSC50 M5 € 1.575,00 1 050001225

RSC50 M7

modulo fisso con 7 cassetti per arredo officina RSC50

- 7 cassetti da 588x367 mm, montati su guide telescopiche a sfera
- Piano dei cassetti protetto da tappetini di gomma espansa
- Serratura centralizzata frontale
- Dotato di piedini regolabili in altezza
- Possibilità di inserire in ogni cassetto fino a 4 vassoi morbidi in EVA o termoformati rigidi in ABS

h	max
70 mm	25 kg
280 mm	35 kg

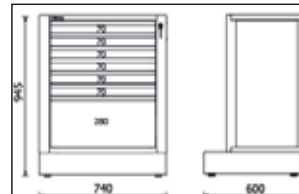
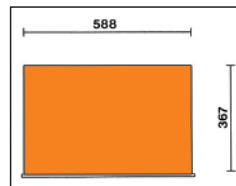

52 kg

RSC50 M7

€ 1.655,00 1 050001227

RSC50 M8

modulo fisso con 8 cassetti per arredo officina RSC50

- 8 cassetti da 588x367 mm, montati su guide telescopiche a sfera
- Piano dei cassetti protetto da tappetini di gomma espansa
- Serratura centralizzata frontale
- Dotato di piedini regolabili in altezza
- Possibilità di inserire in ogni cassetto fino a 4 vassoi morbidi in EVA o termoformati rigidi in ABS

h	max
70 mm	25 kg
140 mm	30 kg

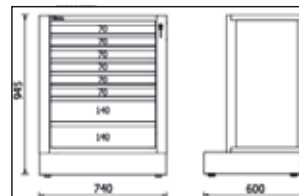
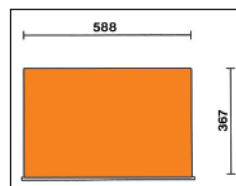

53,2 kg

RSC50 M8

€ 1.700,00 1 050001228

RSC50 M10

modulo fisso con 10 cassetti per arredo officina RSC50

- 10 cassetti da 588x367 mm, montati su guide telescopiche a sfera
- Piano dei cassetti protetto da tappetini di gomma espansa
- Serratura centralizzata frontale
- Dotato di piedini regolabili in altezza
- Possibilità di inserire in ogni cassetto fino a 4 vassoi morbidi in EVA o termoformati rigidi in ABS

h	max
70 mm	25 kg

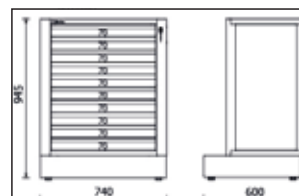
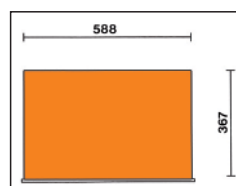

58,2 kg

RSC50 M10

€ 1.780,00 1 050001230

RSC50 MS-2C

modulo fisso di servizio per arredo officina RSC50

- Vano portarifiuti integrato
- Vano portacarta per rotoli preforati
- Due cassette da 310x370 mm, altezza 180mm, montati su guide telescopiche a sfera (misure interne)
- Dotato di piedini regolabili in altezza

📦 57 kg

RSC50 MS-2C

€ 1.555,00



1



050001243

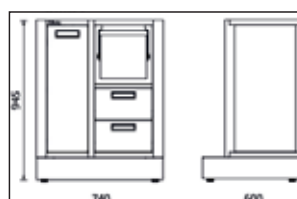

RSC50 MS-AVV

modulo fisso di servizio per arredo officina RSC50, vuoto

Predisposizione per l'inserimento di un avvolgitore a scelta tra i seguenti modelli:

- avvolgitubo per aria compressa art. 1900S 8x10
- avvolgicavi elettrici artt. 1843 15-H05, 1844 10-H05, 1844 15-H05, 1844 15-H07, 1844 15-H05/SCK, 1844 15-H07/SCK, 1845 12-H05, 1846 10-H05, 1846 10-H07 e 1846 15-H05

- Vano portarifiuti integrato
- Vano portacarta per rotoli preforati
- Dotato di piedini regolabili in altezza

📦 41,5 kg

RSC50 MS-AVV

€ 1.430,00



1



050001241

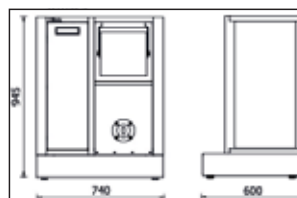

RSC50 MS-2AVV

modulo fisso di servizio per arredo officina RSC50, vuoto

Predisposizione per l'inserimento di due avvolgitori a scelta tra i seguenti modelli:

- avvolgitubo per aria compressa art. 1900S 8x10
- avvolgicavi elettrici artt. 1843 15-H05, 1844 10-H05, 1844 15-H05, 1844 15-H07, 1844 15-H05/SCK, 1844 15-H07/SCK, 1845 12-H05, 1846 10-H05, 1846 10-H07 e 1846 15-H05

- Vano portarifiuti integrato
- Vano portacarta per rotoli preforati
- Dotato di piedini regolabili in altezza

📦 41,7 kg

RSC50 MS-2AVV

€ 1.485,00



1



050001242

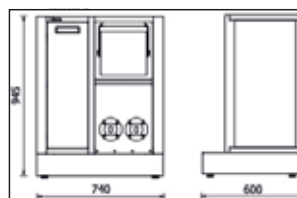

RSC50 MA

modulo fisso con 2 antine per arredo officina RSC50

- Dotato di serratura
- Ripiano interno regolabile in altezza
- Misure interne mm 615x435x740
- Dotato di piedini regolabili in altezza

34 kg

RSC50 MA

€ 1.280,00 1 050001222

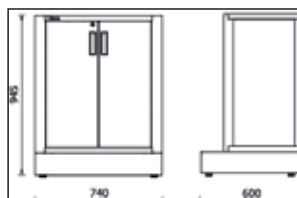

RSC50 CS

modulo fisso per rifiuti differenziati per arredo officina RSC50

- Vano spazzatura estraibile da mm 588x355x580, montato su guide telescopiche a sfera
- 2 capienti contenitori interni estraibili per differenziare i rifiuti
- Dotato di piedini regolabili in altezza

36 kg

RSC50 CS

€ 1.485,00 1 050001245

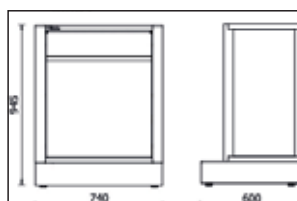

RSC50 ML

modulo fisso con lavandino integrato per arredo officina RSC50

Caratteristiche tecniche:

- Vasca in acciaio inossidabile
- Fornito completo di:
 - 1 rubinetto miscelatore
 - 1 gruppo di scarico
 - 1 tappo di chiusura
 - 1 tappo filtro
 - 1 erogatore per sapone

Modulo fisso con due antine dotato di serratura:

- Misure utili interne 615x435x575 mm
- Dotato di piedini regolabili in altezza

33,5 kg

RSC50 ML

€ 1.595,00 1 050001244

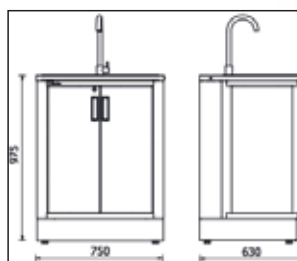

RSC50 MDO

modulo fisso di distribuzione olio per arredo officina RSC50

- 2 arrotolatori con tubo flessibile da 7m - 1/2" inclusi
- Completo di 2 pistole con conta litri digitali dotate di salvagoccia automatico.
 - portata max: 30 l/min
 - viscosità: 8÷2000 mPas
- Dotato di piedini regolabili in altezza

📦 74 kg

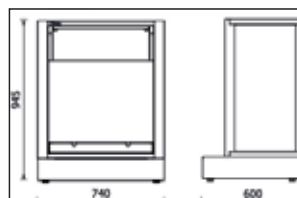

RSC50 MDO

€ 2.890,00 1 050001250

RSC50 T3

carrello a 3 ripiani per arredo officina RSC50

- Quattro ruote girevoli Ø 100 mm (due con freno)
- Capacità di carico statico: 200 kg. (distribuita sui 3 ripiani)

📦 22,3 kg

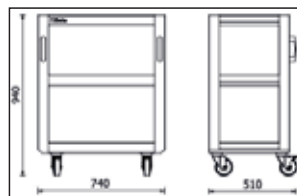

RSC50 T3

€ 350,00 1 050001253



RSC50 KPF

kit pannelli forati per arredo officina RSC50 composto da:

Il Kit è composto da:

- Un pannello forato portautensili superiore 650x400x25 mm
- Un pannello forato portautensili inferiore 650x625x25 mm, con predisposizione per l'inserimento di una multipresa rack 19" (non inclusa)
- Una coppia di montanti DX-SX

14,8 kg

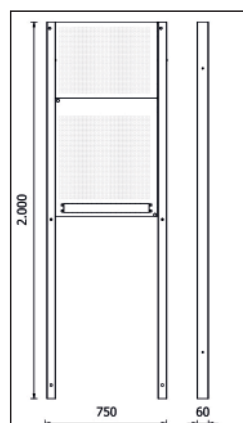
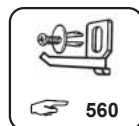

RSC50 KPF

€ 595,00 1 050001310

RSC50 PFS

pannello forato superiore per arredo officina RSC50

- Pannello forato, misure 650x400x25 mm, per il sostegno degli utensili

2,5 kg

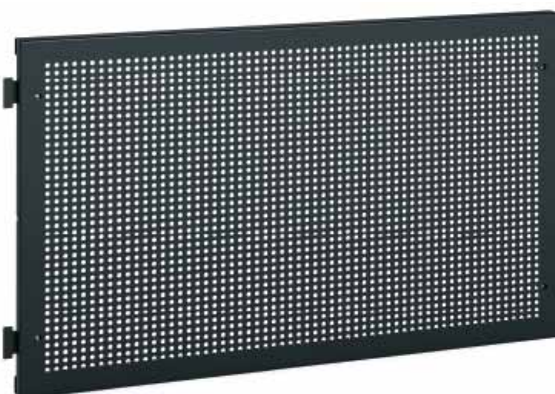
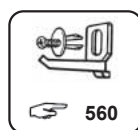

RSC50 PFS

€ 169,50 1 050001312

RSC50 PFI

pannello forato inferiore per arredo officina RSC50

- Pannello forato inferiore, misure mm 650x625x25, per il sostegno degli utensili
- Predisposizione per l'inserimento di una multipresa rack 19" (non inclusa)

3,8 kg



RSC50 PFI

€ 193,50 1 050001313

RSC50 P/2MDX-SX

coppia di montanti DX-SX per pareti forate arredo officina RSC50

8,5 kg

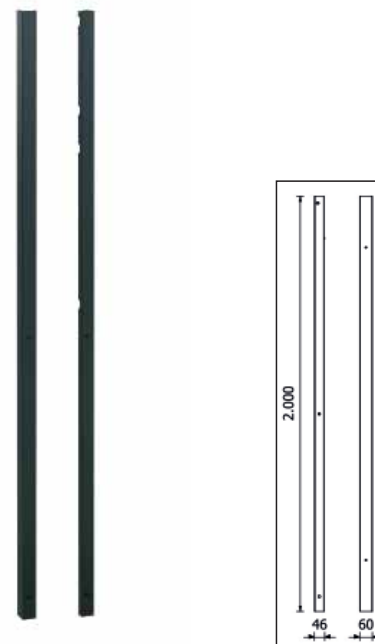

RSC50 P/2MDX-SX

€ 232,00 1 050001352

RSC50 PM

pensile a muro per arredo officina RSC50

- Misure 740x300x400 mm
- Dotato di molle a gas per facilitare l'apertura e la chiusura dell'anta
- Predisposto per l'applicazione dei profili in alluminio con strip LED art. 5000 RSC50/PLED o 5000 RSC50/PLED-ST (da ordinare separatamente), per illuminare la zona di lavoro sottostante e/o l'interno del pensile stesso.

14 kg



RSC50 PM

€ 552,00 1 050001302

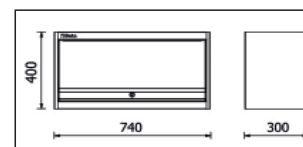

RSC50 MTP

mensola triangolare per arredo officina RSC50

- Misure 740x300x400 mm
- Predisposta per l'applicazione dei profili in alluminio con strip LED art. 5000 RSC50/PLED o 5000 RSC50/PLED-ST (da ordinare separatamente), per illuminare la zona di lavoro sottostante

6,5 kg



RSC50 MTP

€ 282,00 1 050001305



RSC50 PS

parete portautensili con tapparella per arredo officina RSC50

- Tapparella in alluminio, manovrabile verticalmente, con serratura
- Pannelli forati amovibili per il sostegno degli utensili
- Fornita con struttura portante

77 kg



RSC50 PS € 2.495,00 1 050001360

RSC50 AC

angolo completo autoportante per arredo officina RSC50

- Piano di lavoro in lamiera verniciata mm 630x630x30 rivestito da uno strato di PVC antiurto e antigraffio resistente agli idrocarburi
- Due pannelli forati portautensili inferiori 650x625x25 mm, con predisposizione per l'inserimento di una multipresa rack 19" (non inclusa)
- Due pannelli forati portautensili superiori 650x400x25 mm
- Fornito completo di struttura portante

41 kg



RSC50 AC-G € 1.935,00 1 050001330
RSC50 AC-A € 1.935,00 1 050001329

RSC50 KAI

elemento angolare 630x630mm inferiore

- Piano di lavoro in lamiera verniciata 630x630 mm rivestito da uno strato di PVC antiurto e antigraffio resistente agli idrocarburi

16 kg



RSC50 KAI-G € 1.115,00 1 050001335
RSC50 KAI-A € 1.115,00 1 050001336

RSC50 A1

armadio in lamiera a 1 anta per arredo officina RSC50

- 4 ripiani amovibili regolabili in altezza
- Pratica barra appendiabiti richiudibile, posizionata sotto il primo ripiano
- Dotato di serratura
- Misure interne 590x615 mm
- Dotato di piedini regolabili in altezza

📦 66 kg

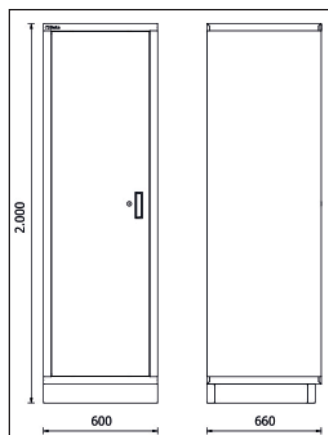

RSC50 A1 € 880,00 1 050001411

RSC50 A1/R59

ripiano interno per armadio RSC50 A1

RSC50 A1/R59 605x596 mm € 55,00 1 050001913

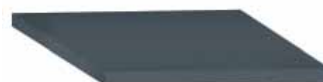

RSC50 A1/RB59

ripiano interno per armadio RSC50 A1 con barra appendiabiti

RSC50 A1/RB59 605x596 mm € 65,00 1 050001914



RSC50 A2

armadio in lamiera a 2 ante per arredo officina RSC50

- 4 ripiani amovibili regolabili in altezza
- Dotato di serratura
- Misure interne 910x615 mm
- Dotato di piedini regolabili in altezza

📦 90 kg



RSC50 A2 € 1.350,00 1 050001412

RSC50 A2/R91

ripiano interno per armadio RSC50 A2

RSC50 A2/R91 911x596 mm € 79,00 1 050001915



5000 RSC50/MP

mensola per arredo ufficio RSC50

- Misure 740x140x80 mm
- Predisposta per l'applicazione dei profili in alluminio con strip LED art. 5000 RSC50/PLED o 5000 RSC50/PLED-ST (da ordinare separatamente), per illuminare la zona di lavoro sottostante

2,3 kg



5000 RSC50/MP

€ 127,50 1 050001705

5000 RSC50/MPA140

mensola angolare prof. 140mm per arredo ufficio RSC50

- Misure 630x630x35 mm, profondità 140mm
- Da applicare ai pannelli forati del modulo angolare RSC50 AC
- Predisposta per l'applicazione dei profili in alluminio con strip LED art. 5000 RSC50/PLED o 5000 RSC50/PLED-ST (da ordinare separatamente), per illuminare la zona di lavoro sottostante

3 kg



5000 RSC50/MPA140

€ 169,00 1 050001706

5000 RSC50/CLL

carter lineare per arredo ufficio RSC50

- Misure 740x125x30 mm
- Da applicare ai pannelli forati portautensili
- Predisposto per l'applicazione dei profili in alluminio con strip LED art. 5000 RSC50/PLED o 5000 RSC50/PLED-ST (da ordinare separatamente), per illuminare la zona di lavoro sottostante

1 kg



5000 RSC50/CLL

€ 127,50 1 050001710

5000 RSC50/CAL

carter angolare per arredo ufficio RSC50

- Misure 655x655x30 mm
- Da applicare ai pannelli forati portautensili del modulo angolare
- Predisposto per l'applicazione dei profili in alluminio con strip LED art. 5000 RSC50/PLED o 5000 RSC50/PLED-ST (da ordinare separatamente), per illuminare la zona di lavoro sottostante

1,7 kg



5000 RSC50/CAL

€ 169,00 1 050001711

5000 RSC50/KFC

kit 10 frontalini colorati per cassetto arredo ufficio RSC50

Permettono di personalizzare il colore dei frontalini dei cassetti dell'arredo ufficio RSC50.

Consigliati in abbinamento ai piani di lavoro in colorazione grigio antracite RAL7016 (-A).

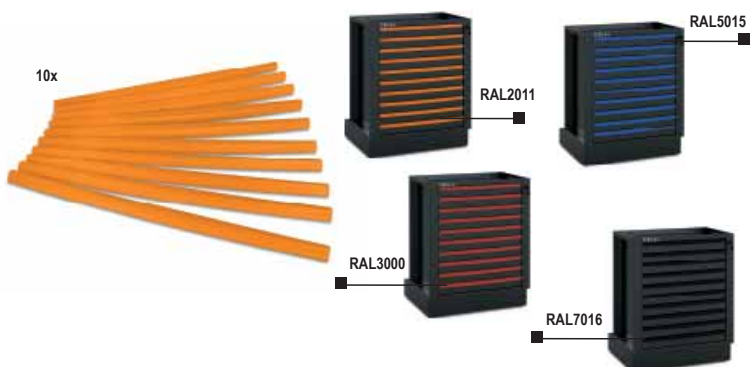

5000 RSC50/KFC2011	€ 89,00	1	050001731
5000 RSC50/KFC3000	€ 89,00	1	050001733
5000 RSC50/KFC5015	€ 89,00	1	050001734
5000 RSC50/KFC7016	€ 89,00	1	050001737

Beta

PROFESSIONALE ROBUSTO ORDINATO

C45PRO è il sistema di arredamento professionale per iniziare a organizzare al meglio il proprio spazio di lavoro. Il nuovo design e i miglioramenti tecnici apportati alla struttura lo posizionano ad un ottimo rapporto qualità/prezzo.

L'arredo per officina modulare **C45PRO** permette di creare il proprio ambiente di lavoro in base agli spazi a disposizione e alle esigenze di utilizzo. È una gamma semplice e flessibile con combinazioni predeterminate che può essere ampliata o modificata nel tempo.

In alternativa è possibile costruire interamente la postazione di lavoro personalizzata partendo dai piani di lavoro - disponibili in MDF rivestito in acciaio inox o in legno multistrato - e completandola con i numerosi componenti e accessori disponibili.

**Crea il tuo ambiente di lavoro a tua misura.
Cambia faccia al tuo laboratorio o alla tua officina.
Scegli tra le soluzioni preassemblate o costruisci da zero la tua postazione.**



L'ARREDO OFFICINA C45 CAMBIA ABITO E INDOSSA I COLORI BETA!

Configura on-line la tua officina in 3D

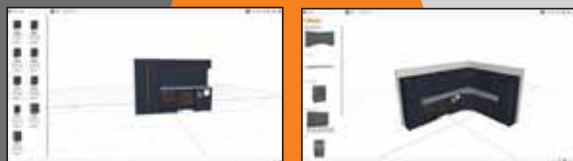

su www.beta-tools.com

C45PRO DX

combinazione arredo officina C45PRO

Combinazione composta da:

- 1 piano di lavoro in MDF rivestito in acciaio inossidabile (C45PX/3-2,0MT)
- 1 piano di lavoro in MDF rivestito in acciaio inossidabile (C45PX/2-1,3MT)
- 1 modulo fisso con 7 cassetti (C45PRO M7)
- 1 cassetiera mobile con 7 cassetti (C45PRO C7)
- 1 modulo fisso di servizio (C45PRO MS)
- 1 modulo fisso con 5 cassetti (C45PRO M5)
- 1 modulo fisso con 2 ante (C45PRO MA)
- 1 angolo completo autoportante con piano di lavoro in MDF rivestito in acciaio inossidabile (C45PRO CORNER/X)
- 5 pannelli forati portautensili (C45PRO PF)
- 5 pensili a muro (C45PRO PM)
- 7 staffe per parete tipo largo (C45PRO SL)
- 2 staffe per parete tipo stretto (C45PRO SS)
- 2 armadi a 1 anta (C45PRO AS1)

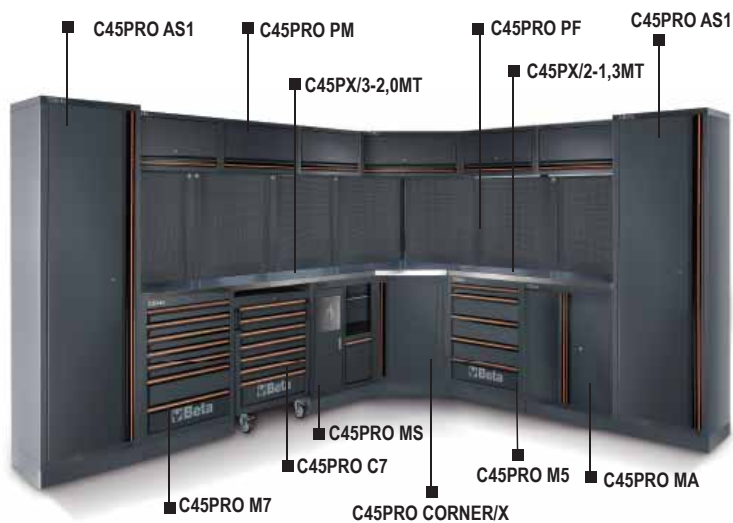

572,3 kg

C45PRO DW

combinazione arredo officina C45PRO

Combinazione composta da:

- 1 piano di lavoro in legno multistrato (C45PW/3-2,0MT)
- 1 piano di lavoro in legno multistrato (C45PW/2-1,3MT)
- 1 modulo fisso con 7 cassetti (C45PRO M7)
- 1 cassetiera mobile con 7 cassetti (C45PRO C7)
- 1 modulo fisso di servizio (C45PRO MS)
- 1 modulo fisso con 5 cassetti (C45PRO M5)
- 1 modulo fisso con 2 antine (C45PRO MA)
- 1 angolo completo autoportante con piano di lavoro in legno (C45PRO CORNER/W)
- 5 pannelli forati portautensili (C45PRO PF)
- 5 pensili a muro (C45PRO PM)
- 7 staffe per parete tipo largo (C45PRO SL)
- 2 staffe per parete tipo stretto (C45PRO SS)
- 2 armadi a 1 anta (C45PRO AS1)

568,5 kg

C45PRO DW

€ 9.550,00 1 045000032

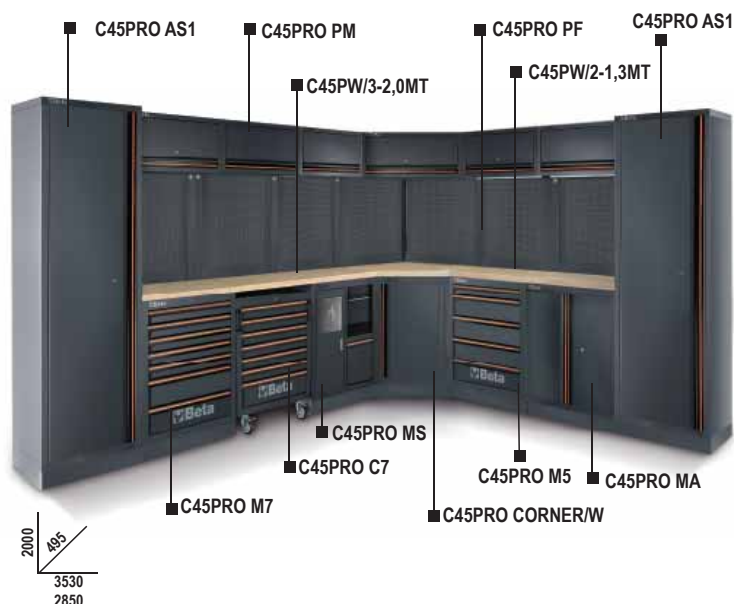

C45PRO FX

combinazione arredo officina C45PRO

Combinazione composta da:

- 1 piano di lavoro in MDF rivestito in acciaio inossidabile (C45PX/3-2,0MT)
- 1 piano di lavoro in MDF rivestito in acciaio inossidabile (C45PX/2-1,3MT)
- 1 modulo fisso con 2 antine (C45PRO MA)
- 1 cassetiera mobile con 7 cassetti (C45PRO C7)
- 1 modulo fisso con 7 cassetti (C45PRO M7)
- 1 modulo fisso con due arrotolatori integrati (C45PRO ACT)
- 1 modulo fisso di servizio (C45PRO MS)
- 1 angolo completo autoportante con piano di lavoro in MDF rivestito in acciaio inossidabile (C45PRO CORNER/X)
- 2 pannelli forati portautensili (C45PRO PF)
- 1 pannello forato portautensili con predisposizione per presa elettrica non inclusa (C45PRO PFE)
- 3 pensili a muro (C45PRO PM)
- 1 parete portautensili con tapparella in alluminio (C45PRO PA)
- 6 staffe per parete tipo largo (C45PRO SL)
- 2 staffe per parete tipo stretto (C45PRO SS)
- 2 armadi a 1 anta (C45PRO AS1)

576 kg

C45PRO FX

€ 10.460,00 1 045000035

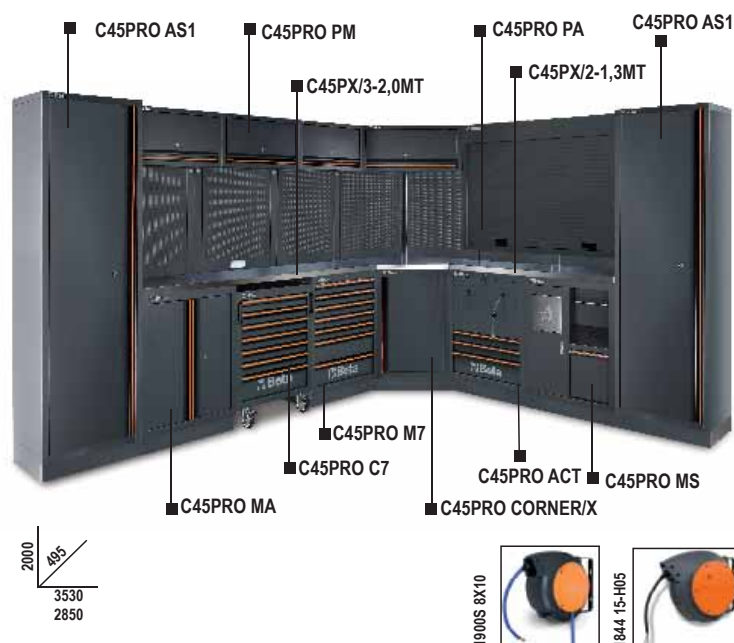

C45PRO FW

combinazione arredo officina C45PRO

Combinazione composta da:

- 1 piano di lavoro in legno multistrato (C45PW/3-2,0MT)
- 1 piano di lavoro in legno multistrato (C45PW/2-1,3MT)
- 1 modulo fisso con 2 antine (C45PRO MA)
- 1 cassetiera mobile con 7 cassetti (C45PRO C7)
- 1 modulo fisso con 7 cassetti (C45PRO M7)
- 1 modulo fisso con due arrotolatori integrati (C45PRO ACT)
- 1 modulo fisso di servizio (C45PRO MS)
- 1 angolo completo autoportante con piano di lavoro in legno multistrato (C45PRO CORNER/W)
- 2 pannelli forati portautensili (C45PRO PF)
- 1 pannello forato portautensili con predisposizione per presa elettrica non inclusa (C45PRO PFE)
- 3 pensili a muro (C45PRO PM)
- 1 parete portautensili con tapparella in alluminio (C45PRO PA)
- 6 staffe per parete tipo largo (C45PRO SL)
- 2 staffe per parete tipo stretto (C45PRO SS)
- 2 armadi a 1 anta (C45PRO AS1)

572 kg

C45PRO FW

€ 10.120,00 1 045000045

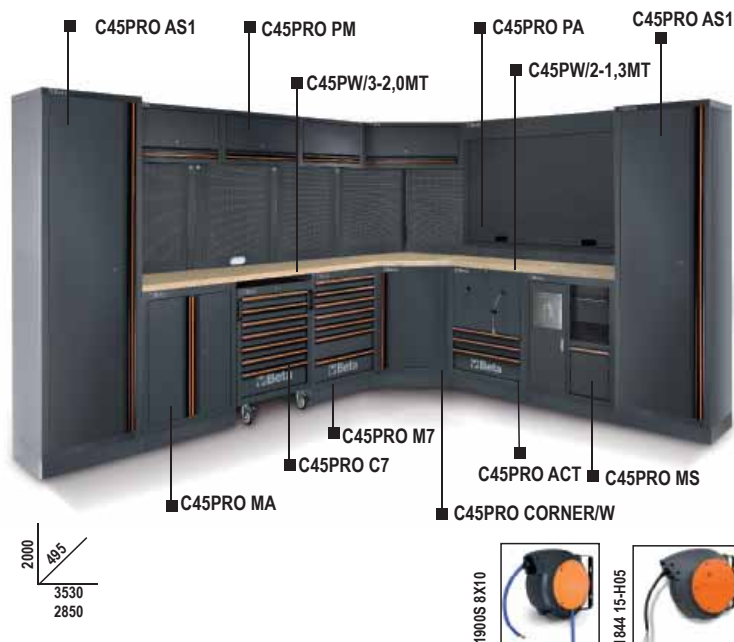

C45PRO GX

combinazione arredo officina C45PRO

Combinazione composta da:

- 1 piano di lavoro in MDF rivestito in acciaio inossidabile (C45PX/3-2,0MT)
- 1 piano di lavoro in MDF rivestito in acciaio inossidabile (C45PX/1-0,7MT)
- 1 modulo fisso con due arrotolatori integrati (C45PRO ACT)
- 1 cassetiera mobile con 7 cassetti (C45PRO C7)
- 1 modulo fisso con 7 cassetti (C45PRO M7)
- 1 modulo fisso con 2 antine (C45PRO MA)
- 1 angolo completo autoportante con piano di lavoro in MDF rivestito in acciaio inossidabile (C45PRO CORNER/X)
- 1 pannello forato portautensili (C45PRO PF)
- 1 pannello forato portautensili con predisposizione per presa elettrica non inclusa (C45PRO PFE)
- 2 pensili a muro (C45PRO PM)
- 1 parete portautensili con tapparella in alluminio (C45PRO PAS)
- 6 staffe per parete tipo largo (C45PRO SL)
- 2 staffe per parete tipo stretto (C45PRO SS)
- 2 armadi a 1 anta (C45PRO AS1)

507 kg

C45PRO GX

€ 9.370,00 1 045000036

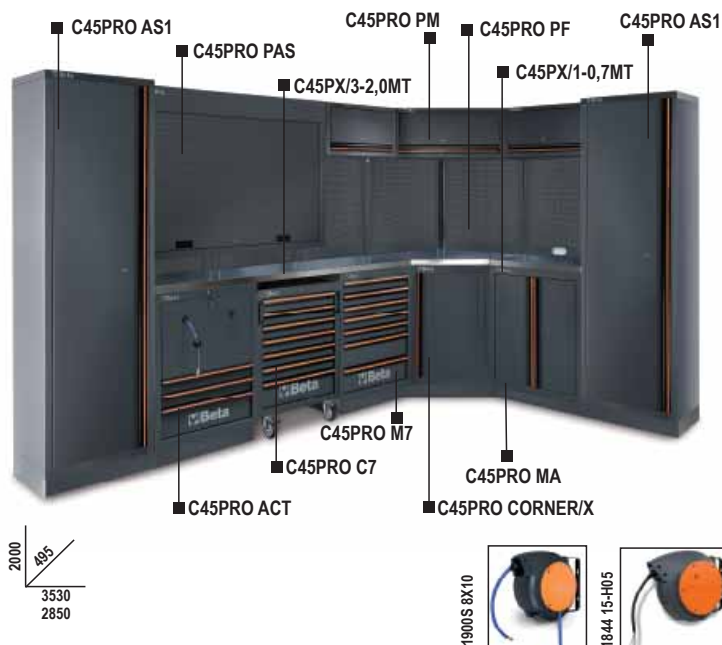

C45PRO GW

combinazione arredo officina C45PRO

Combinazione composta da:

- 1 piano di lavoro in legno multistrato (C45PW/3-2,0MT)
- 1 piano di lavoro in legno multistrato (C45PW/1-0,7MT)
- 1 modulo fisso con due arrotolatori integrati (C45PRO ACT)
- 1 cassetiera mobile con 7 cassetti (C45PRO C7)
- 1 modulo fisso con 7 cassetti (C45PRO M7)
- 1 modulo fisso con 2 antine (C45PRO MA)
- 1 angolo completo autoportante con piano di lavoro in legno multistrato (C45PRO CORNER/W)
- 1 pannello forato portautensili (C45PRO PF)
- 1 pannello forato portautensili con predisposizione per presa elettrica non inclusa (C45PRO PFE)
- 2 pensili a muro (C45PRO PM)
- 1 parete portautensili con tapparella in alluminio (C45PRO PAS)
- 6 staffe per parete tipo largo (C45PRO SL)
- 2 staffe per parete tipo stretto (C45PRO SS)
- 2 armadi a 1 anta (C45PRO AS1)

504 kg

C45PRO GW

€ 9.070,00 1 045000037

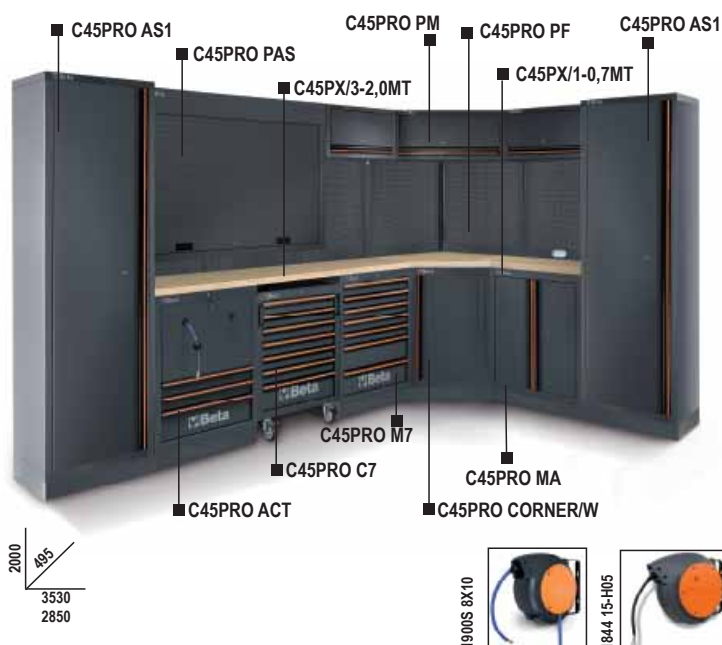

C45PRO X

combinazione arredo officina C45PRO

Combinazione composta da:

- Piano di lavoro in MDF rivestito in acciaio inossidabile (C45PX/3-2,0MT)
- Modulo fisso con 7 cassetti (C45PRO M7)
- Modulo fisso di servizio (C45PRO MS)
- Cassetiera mobile con 7 cassetti (C45PRO C7)
- Armadio a 2 ante (C45PRO AS2)
- 3 pannelli forati portautensili (C45PRO PF)
- 3 pensili a muro (C45PRO PM)
- 3 staffe per parete tipo largo (C45PRO SL)
- 1 staffa per parete tipo stretto (C45PRO SS)

305 kg

C45PRO X

€ 4.990,00 1 045000001



C45PRO W

combinazione arredo officina C45PRO

Combinazione composta da:

- Piano di lavoro in legno multistrato (C45PW/3-2,0MT)
- Modulo fisso con 7 cassetti (C45PRO M7)
- Modulo fisso di servizio (C45PRO MS)
- Cassettiera mobile con 7 cassetti (C45PRO C7)
- Armadio a 2 ante (C45PRO AS2)
- 3 pannelli forati portautensili (C45PRO PF)
- 3 pensili a muro (C45PRO PM)
- 3 staffe per parete tipo largo (C45PRO SL)
- 1 staffa per parete tipo stretto (C45PRO SS)

303 kg

C45PRO W

€ 4.860,00 1 045000002

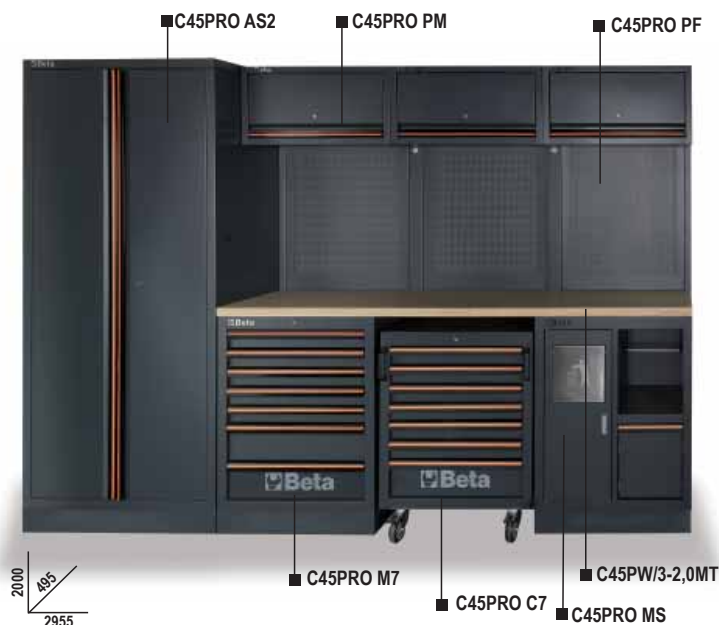

C45PRO HX

combinazione arredo officina C45PRO

Combinazione composta da:

- 1 Piano di lavoro in MDF rivestito in acciaio inossidabile (C45PX/3-2,0MT)
- 1 Modulo fisso con due arrotolatori integrati (C45PRO ACT)
- 1 Cassettiera mobile con 7 cassetti (C45PRO C7)
- 1 Modulo fisso con 4 cassetti (C45PRO M4)
- 3 pensili a muro (C45PRO PM)
- 3 pannelli forati portautensili (C45PRO PF)
- 3 staffe per parete tipo largo (C45PRO SL)
- 1 staffa per parete tipo stretto (C45PRO SS)
- 1 Armadio a 2 ante (C45PRO AS2)

300 kg

C45PRO HX

€ 5.370,00 1 045000038

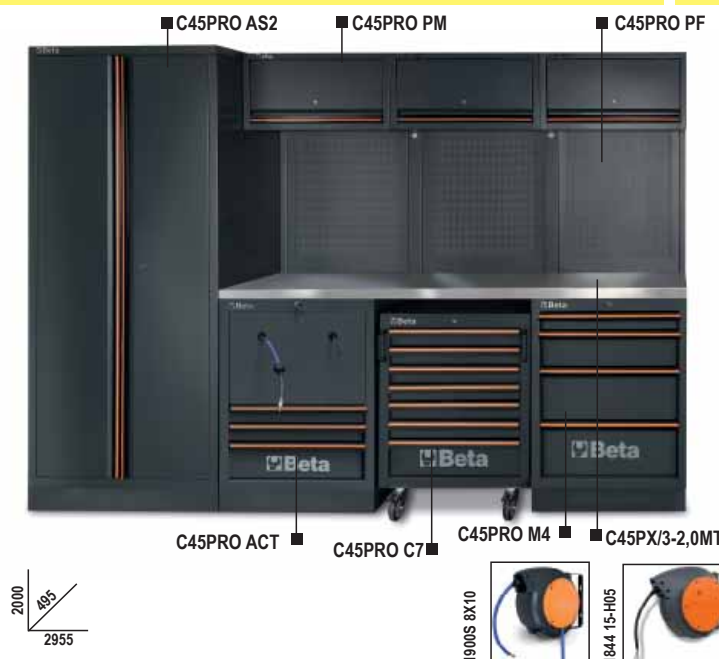

C45PRO HW

combinazione arredo officina C45PRO

Combinazione composta da:

- 1 Piano di lavoro in legno multistrato (C45PW/3-2,0MT)
- 1 Modulo fisso con due arrotolatori integrati (C45PRO ACT)
- 1 Cassettiera mobile con 7 cassetti (C45PRO C7)
- 1 Modulo fisso con 4 cassetti (C45PRO M4)
- 3 pensili a muro (C45PRO PM)
- 3 pannelli forati portautensili (C45PRO PF)
- 3 staffe per parete tipo largo (C45PRO SL)
- 1 staffa per parete tipo stretto (C45PRO SS)
- 1 Armadio a 2 ante (C45PRO AS2)

299 kg

C45PRO HW

€ 5.240,00 1 045000039

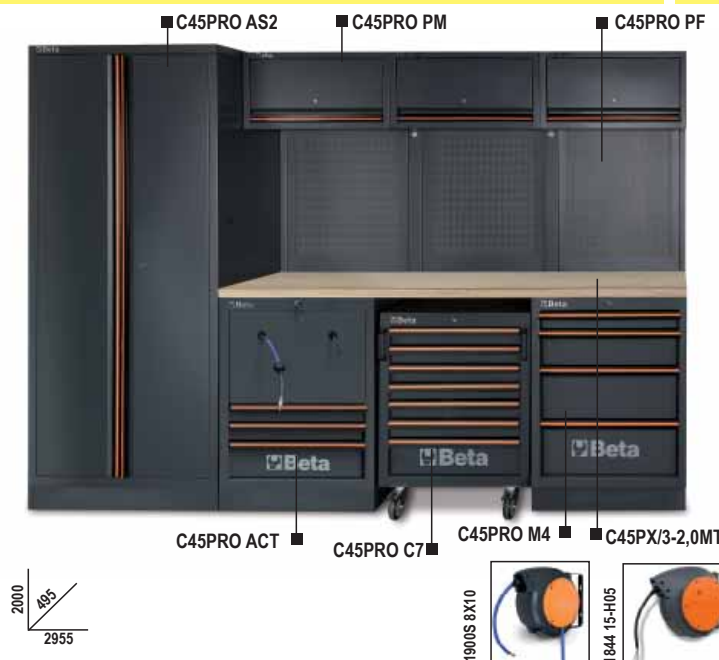

C45PRO AX

combinazione arredo officina C45PRO

Combinazione composta da:

- Piano di lavoro in MDF rivestito in acciaio inossidabile (C45PX/3-2,0MT)
- Modulo fisso con 7 cassetti (C45PRO M7)
- Modulo fisso di servizio (C45PRO MS)
- Modulo fisso con 2 antine (C45PRO MA)
- 3 pensili a muro (C45PRO PM)
- 3 pannelli forati portautensili (C45PRO PF)
- 2 staffe per parete tipo largo (C45PRO SL)
- 2 staffe per parete tipo stretto (C45PRO SS)

206 kg

C45PRO AX

€ 3.470,00



1

045000003



C45PRO AW

combinazione arredo officina C45PRO

Combinazione composta da:

- Piano di lavoro in legno multistrato (C45PW/3-2,0MT)
- Modulo fisso con 2 antine (C45PRO MA)
- Modulo fisso con 7 cassetti (C45PRO M7)
- Modulo fisso di servizio (C45PRO MS)
- 3 pensili a muro (C45PRO PM)
- 3 pannelli forati portautensili (C45PRO PF)
- 2 staffe per parete tipo stretto (C45PRO SS)
- 2 staffe per parete tipo largo (C45PRO SL)

204 kg

C45PRO AW

€ 3.340,00



1

045000004



C45PRO BX

combinazione arredo officina C45PRO

Combinazione composta da:

- Piano di lavoro in MDF rivestito in acciaio inossidabile (C45PX/2-1,3MT)
- Modulo fisso con 5 cassetti (C45PRO M5)
- Modulo fisso con 2 antine (C45PRO MA)
- Armadio a 1 anta (C45PRO AS1)
- 2 pensili a muro (C45PRO PM)
- 2 pannelli forati portautensili (C45PRO PF)
- 2 staffe per parete tipo largo (C45PRO SL)
- 1 staffa per parete tipo stretto (C45PRO SS)

191 kg

C45PRO BX

€ 3.130,00



1

045000021



C45PRO BW

combinazione arredo officina C45PRO

Combinazione composta da:

- Piano di lavoro in legno multistrato (C45PW/2-1,3MT)
- Modulo fisso con 5 cassetti (C45PRO M5)
- Modulo fisso con 2 antine (C45PRO MA)
- Armadio a 1 anta (C45PRO AS1)
- 2 pensili a muro (C45PRO PM)
- 2 pannelli forati portautensili (C45PRO PF)
- 2 staffe per parete tipo largo (C45PRO SL)
- 1 staffa per parete tipo stretto (C45PRO SS)

190 kg

C45PRO BW

€ 3.000,00 1 045000022

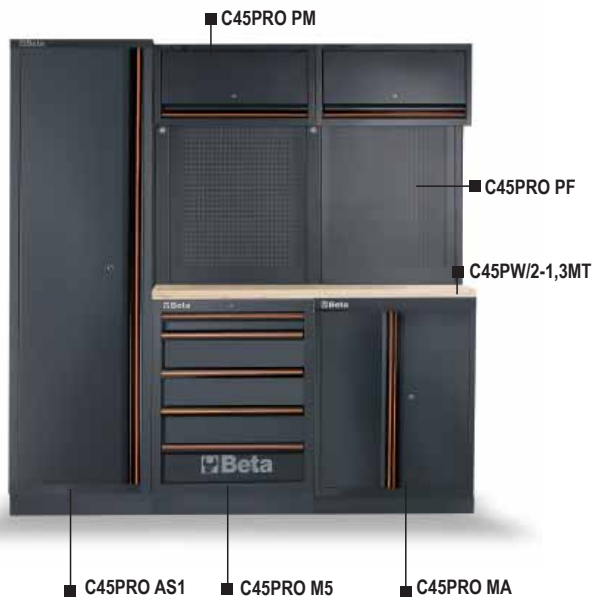

C45PRO EX

combinazione arredo officina C45PRO

Combinazione composta da:

- 2 pannelli forati portautensili (C45PRO PF)
- 2 pensili a muro (C45PRO PM)
- 2 staffe per parete tipo largo (C45PRO SL)
- 1 staffa per parete tipo stretto (C45PRO SS)
- 1 armadio a 1 anta (C45PRO AS1)
- Modulo fisso con 7 cassetti e piano di lavoro in MDF rivestito in acciaio inossidabile (C45PRO M7A/X):
 - 1 cassetto da 1248x406 mm
 - 6 cassetti da 782x406 mm
 - 5 cassetti altezza 65 mm
 - 1 cassetto altezza 145 mm
- 1 vano portaoggetti con ripiano intermedio e antina di chiusura

174,6 kg

C45PRO EX

€ 3.320,00 1 045000033



C45PRO EW

combinazione arredo officina C45PRO

Combinazione composta da:

- 2 pannelli forati portautensili (C45PRO PF)
- 2 pensili a muro (C45PRO PM)
- 2 staffe per parete tipo largo (C45PRO SL)
- 1 staffa per parete tipo stretto (C45PRO SS)
- 1 armadio a 1 anta (C45PRO AS1)
- Modulo fisso con 7 cassetti e piano di lavoro in legno multistrato (C45PRO M7A/W):
 - 1 cassetto da 1248x406 mm
 - 6 cassetti da 782x406 mm
 - 5 cassetti altezza 65 mm
 - 1 cassetto altezza 145 mm
- 1 vano portaoggetti con ripiano intermedio e antina di chiusura

173,6 kg

C45PRO EW

€ 3.210,00 1 045000034



C45PRO CX

combinazione arredo officina C45PRO

Combinazione composta da:

- Piano di lavoro in MDF rivestito in acciaio inossidabile (C45PX/2-1,3MT)
- Modulo fisso con 7 cassetti (C45PRO M7)
- Modulo fisso di servizio (C45PRO MS)
- Armadio a 1 anta (C45PRO AS1)
- 2 pensili a muro (C45PRO PM)
- 2 pannelli forati portautensili (C45PRO PF)
- 2 staffe per parete tipo largo (C45PRO SL)
- 1 staffa per parete tipo stretto (C45PRO SS)

199 kg

C45PRO CX

€ 3.350,00 1 045000023



C45PRO CW

combinazione arredo officina C45PRO

Combinazione composta da:

- Piano di lavoro in legno multistrato (C45PW/2-1,3MT)
- Modulo fisso con 7 cassetti (C45PRO M7)
- Modulo fisso di servizio (C45PRO MS)
- Armadio a 1 anta (C45PRO AS1)
- 2 pensili a muro (C45PRO PM)
- 2 pannelli forati portautensili (C45PRO PF)
- 2 staffe per parete tipo largo (C45PRO SL)
- 1 staffa per parete tipo stretto (C45PRO SS)

198 kg

C45PRO CW

€ 3.220,00 1 045000024



C45PRO BPX-2,0

combinazione banchi arredo officina C45PRO

Combinazione composta da:

- Piano di lavoro in MDF rivestito in acciaio inossidabile (C45PX/3-2,0MT)
- Modulo fisso con 7 cassetti (C45PRO M7)
- Modulo fisso con 5 cassetti (C45PRO M5)
- 3 pannelli forati portautensili (C45PRO PF)
- 2 staffe per parete tipo largo (C45PRO SL)
- 2 staffe per parete tipo stretto (C45PRO SS)

158 kg

C45PRO BPX-2,0

€ 2.530,00 1 045000042



C45PRO BPW-2,0

combinazione banchi arredo officina C45PRO

Combinazione composta da:

- Piano di lavoro in legno multistrato (C45PW/3-2,0MT)
- Modulo fisso con 7 cassetti (C45PRO M7)
- Modulo fisso con 5 cassetti (C45PRO M5)
- 3 pannelli forati portautensili (C45PRO PF)
- 2 staffe per parete tipo largo (C45PRO SL)
- 2 staffe per parete tipo stretto (C45PRO SS)

156 kg

C45PRO BPW-2,0

€ 2.400,00 1 045000052



C45PRO BPX-1,3

combinazione banchi arredo officina C45PRO

Combinazione composta da

- Piano di lavoro in MDF rivestito in acciaio inossidabile (C45PX/2-1,3MT)
- Modulo fisso con 7 cassetti (C45PRO M7)
- Modulo fisso con 5 cassetti (C45PRO M5)
- 2 pannelli forati portautensili (C45PRO PF)
- 1 staffa per parete tipo largo (C45PRO SL)
- 2 staffe per parete tipo stretto (C45PRO SS)

140 kg

C45PRO BPX-1,3

€ 2.245,00 1 045000041



C45PRO BPW-1,3

combinazione banchi arredo officina C45PRO

Combinazione composta da:

- Piano di lavoro in legno multistrato (C45PW/2-1,3MT)
- Modulo fisso con 7 cassetti (C45PRO M7)
- Modulo fisso con 5 cassetti (C45PRO M5)
- 2 pannelli forati portautensili (C45PRO PF)
- 1 staffa per parete tipo largo (C45PRO SL)
- 2 staffe per parete tipo stretto (C45PRO SS)

139 kg

C45PRO BPW-1,3

€ 2.120,00 1 045000051



C45PRO M7A/X

modulo fisso con 7 cassetti per arredo officina C45PRO

- Piano di lavoro da 1360 mm in MDF rivestito in acciaio inossidabile
- 1 cassetto da 1248x406 mm, montato su guide telescopiche a sfera
- 6 cassetti da 782x406 mm, montati su guide telescopiche a sfera:
 - 5 cassetti altezza 65 mm
 - 1 cassetto altezza 145 mm
- Piano dei cassetti protetto da tappetini di gomma espansa
- Serratura centralizzata frontale
- Dotato di piedini regolabili in altezza
- Predisposizione per l'inserimento dei termoformati
- 1 vano portaoggetti con ripiano intermedio e antina di chiusura, misure interne 504x424x597 mm
- Possibilità di montaggio di una morsa 1599P/150 da ordinare separatamente

81 kg

C45PRO M7A/X

€ 1.675,00 1 045000161



h	max
65 mm	25 kg
105 mm	40 kg
145 mm	30 kg

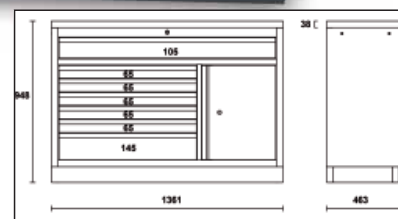

C45PRO M7A/W

modulo fisso con 7 cassetti per arredo officina C45PRO

- Piano di lavoro da 1360mm in legno multistrato
- 1 cassetto da 1248x406 mm, montato su guide telescopiche a sfera
- 6 cassetti da 782x406 mm, montati su guide telescopiche a sfera:
 - 5 cassetti altezza 65 mm
 - 1 cassetto altezza 145 mm
- Piano dei cassetti protetto da tappetini di gomma espansa
- Serratura centralizzata frontale
- Dotato di piedini regolabili in altezza
- Predisposizione per l'inserimento dei termoformati
- 1 vano portaoggetti con ripiano intermedio e antina di chiusura, misure interne 504x424x597 mm
- Possibilità di montaggio di una morsa 1599P/150 da ordinare separatamente

80 kg

C45PRO M7A/W

€ 1.565,00 1 045000171



h	max
65 mm	25 kg
105 mm	40 kg
145 mm	30 kg

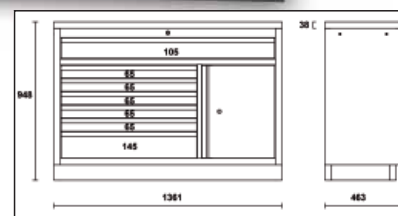

C45PRO MWS/X

cassettiera mobile Work Station con 7 cassetti e cestino portarifiuti integrato

- Piano di lavoro da 1680 mm in MDF rivestito in acciaio inossidabile
- 1 cassetto da 1248x406 mm, montato su guide telescopiche a sfera
- 6 cassetti da 782x406 mm, montati su guide telescopiche a sfera:
 - 5 cassetti altezza 65 mm
 - 1 cassetto altezza 145 mm
- Piano dei cassetti protetto da tappetini di gomma espansa
- Predisposizione per l'inserimento dei termoformati
- Vano portaoggetti con ripiano intermedio e antina di chiusura, misure interne 504x424x597mm
- Cestino portarifiuti integrato
- Supporto portacarta integrato
- 4 ruote Ø 150 mm alta portata, 2 fisse e 2 girevoli con freno
- Serratura centralizzata frontale
- Possibilità di montaggio di una morsa 1599P/150 da ordinare separatamente

126 kg

C45PRO MWS/X

€ 1.775,00 1 045000181



h	max
65 mm	25 kg
105 mm	40 kg
145 mm	30 kg

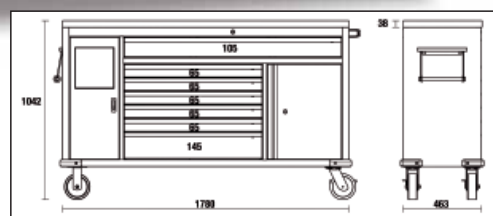

C45PRO MWS/W

cassettiera mobile Work Station con 7 cassetti e cestino portarifiuti integrato

- Piano di lavoro da 1680 mm in legno multistrato
- 1 cassetto da 1248x406 mm, montato su guide telescopiche a sfera
- 6 cassetti da 782x406 mm, montati su guide telescopiche a sfera:
 - 5 cassetti altezza 65 mm
 - 1 cassetto altezza 145 mm
- Piano dei cassetti protetto da tappetini di gomma espansa
- Predisposizione per l'inserimento dei termoformati
- Vano portaoggetti con ripiano intermedio e antina di chiusura, misure interne 504x424x597mm
- Cestino portarifiuti integrato
- Supporto portacarta integrato
- 4 ruote Ø 150 mm alta portata, 2 fisse e 2 girevoli con freno
- Serratura centralizzata frontale
- Possibilità di montaggio di una morsa 1599P/150 da ordinare separatamente

122 kg

C45PRO MWS/W

€ 1.730,00 1 045000191



h	max
65 mm	25 kg
105 mm	40 kg
145 mm	30 kg

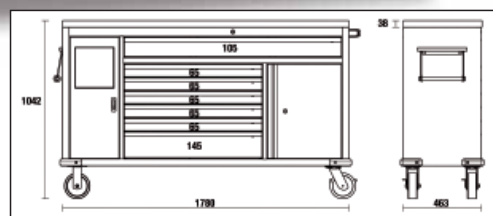

C45PRO CPF

coppia di pannelli forati portautensili per cassettiera mobile C45PRO MWS

Fornita completa di struttura portante
Kit di 50 ganci GPS incluso

xxx kg

C45PRO CPF

€ 230,00 1 045000195

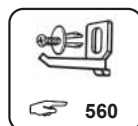

C45PX/1-0,7MT

piano di lavoro in MDF rivestito in acciaio inossidabile 680x463 mm, per banco arredo officina C45PRO

- spessore 38 mm
- possibilità di montaggio di una morsa 1599P/150 da ordinare separatamente

6 kg

C45PX/1-0,7MT

€ 215,50 1 045000101



C45PW/1-0,7MT

piano di lavoro in legno multistrato 680x463 mm, per banco arredo officina C45PRO

- spessore 38 mm
- possibilità di montaggio di una morsa 1599P/150 da ordinare separatamente

6 kg

C45PW/1-0,7MT

€ 127,00 1 045000111



C45PX/2-1,3MT

piano di lavoro in MDF rivestito in acciaio inossidabile 1360x463 mm, per banco arredo officina C45PRO

- spessore 38 mm
- possibilità di montaggio di una morsa 1599P/150 da ordinare separatamente

📦 21 kg

C45PX/2-1,3MT € 344,00 1 045000103



C45PW/2-1,3MT

piano di lavoro in legno multistrato 1360x463 mm, per banco arredo officina C45PRO

- spessore 38 mm
- possibilità di montaggio di una morsa 1599P/150 da ordinare separatamente

📦 20 kg

C45PW/2-1,3MT € 219,50 1 045000113



C45PX/3-2,0MT

piano di lavoro in MDF rivestito in acciaio inossidabile 2040x463 mm, per banco arredo officina C45PRO

- spessore 38 mm
- possibilità di montaggio di una morsa 1599P/150 da ordinare separatamente

📦 31,8 kg

C45PX/3-2,0MT € 461,00 1 045000110



C45PW/3-2,0MT

piano di lavoro in legno multistrato 2040x463 mm, per banco arredo officina C45PRO

- spessore 38 mm
- possibilità di montaggio di una morsa 1599P/150 da ordinare separatamente

📦 30 kg

C45PW/3-2,0MT € 329,00 1 045000120



C45PRO C5

cassettiera mobile con 5 cassetti per arredo officina C45PRO

- 5 cassetti da 532x406 mm, montati su guide telescopiche a sfera
- 4 ruote girevoli Ø 100 mm (2 con freno)
- Piano dei cassetti protetto da tappetini di gomma espansa
- Serratura centralizzata frontale
- Predisposizione per l'inserimento dei termoformati
- Maniglie integrate nella struttura per una facile movimentazione

📦 46 kg

C45PRO C5 € 804,00 1 045000225

h	max
65 mm	25 kg
145 mm	30 kg

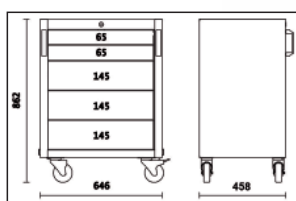
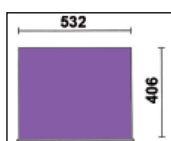

C45PRO C7

cassettiera mobile con 7 cassetti per arredo officina C45PRO

- 7 cassetti da 532x406 mm, montati su guide telescopiche a sfera
- 4 ruote girevoli Ø 100 mm (2 con freno)
- Piano dei cassetti protetto da tappetini di gomma espansa
- Serratura centralizzata frontale
- Predisposizione per l'inserimento dei termoformati
- Maniglie integrate nella struttura per una facile movimentazione

📦 50 kg

h	max
65 mm	25 kg
145 mm	30 kg

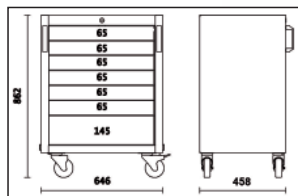
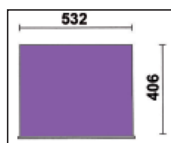

C45PRO C7

€ 842,00 1 045000227

C45PRO M4

modulo fisso con 4 cassetti per arredo officina C45PRO

- 4 cassetti da 566x406 mm, montati su guide telescopiche a sfera
- Piano dei cassetti protetto da tappetini di gomma espansa
- Serratura centralizzata frontale
- Dotato di piedini regolabili in altezza
- Predisposizione per l'inserimento dei termoformati

📦 45,7 kg

h	max
65 mm	25 kg
145 mm	30 kg
225 mm	30 kg

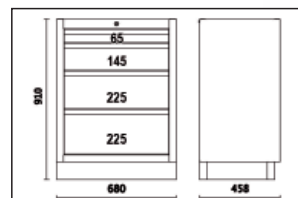
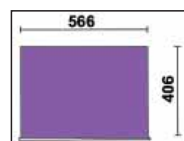

C45PRO M4

€ 690,00 1 045000234

C45PRO M5

modulo fisso con 5 cassetti per arredo officina C45PRO

- 5 cassetti da 566x406 mm, montati su guide telescopiche a sfera
- Piano dei cassetti protetto da tappetini di gomma espansa
- Serratura centralizzata frontale
- Dotato di piedini regolabili in altezza
- Predisposizione per l'inserimento dei termoformati

📦 49,3 kg

h	max
65 mm	25 kg
145 mm	30 kg

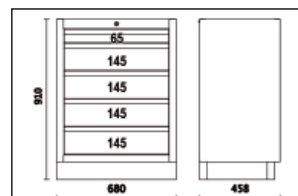
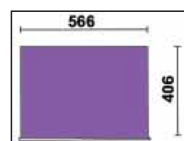

C45PRO M5

€ 730,00 1 045000235

C45PRO M7

modulo fisso con 7 cassetti per arredo officina C45PRO

- 7 cassetti da 566x406 mm, montati su guide telescopiche a sfera
- Piano dei cassetti protetto da tappetini di gomma espansa
- Serratura centralizzata frontale
- Dotato di piedini regolabili in altezza
- Predisposizione per l'inserimento dei termoformati

📦 54,3 kg

h	max
65 mm	25 kg
145 mm	30 kg

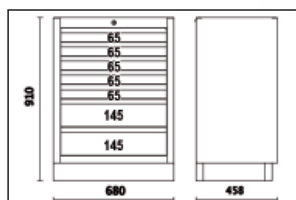
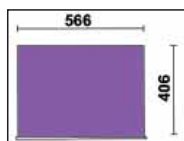

C45PRO M7

€ 810,00 1 045000237

C45PRO M8

modulo fisso con 8 cassetti per arredo officina C45PRO

- 8 cassetti da 566x406 mm, montati su guide telescopiche a sfera
- Piano dei cassetti protetto da tappetini di gomma espansa
- Serratura centralizzata frontale
- Dotato di piedini regolabili in altezza
- Predisposizione per l'inserimento dei termoformati

📦 56,5 kg

h	max
65 mm	25 kg
145 mm	30 kg

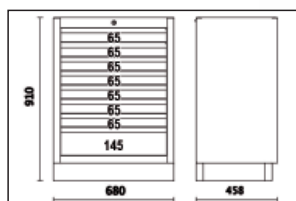
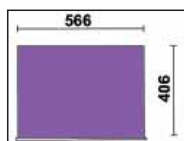

C45PRO M8

€ 881,00 1 045000238

C45PRO MS

modulo fisso di servizio per arredo officina C45PRO

- Cestino portarifiuti integrato
- Vano portacarta per rotoli preforati
- Dotato di piedini regolabili in altezza

📦 37 kg

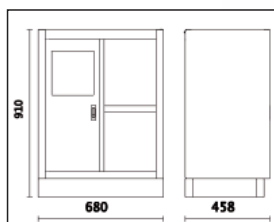

C45PRO MS

€ 551,00 1 045000239

C45PRO RD/X

modulo fisso raccolta differenziata per arredo officina C45PRO

80 kg

C45PRO RD/X	€ 1.700,00	1	045000241
C45PRO RD/W	€ 1.590,00	1	045000240



C45PRO RD/X



C45PRO RD/W

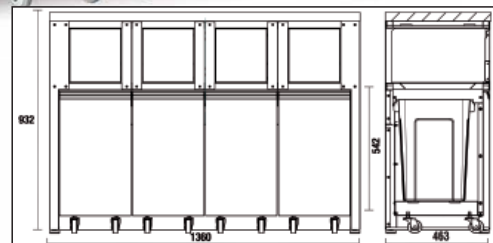

C45PRO MA

modulo fisso con 2 antine per arredo officina C45PRO

- Dotato di serratura
- Ripiano interno regolabile in altezza
- Misure interne 670x420 mm
- Dotato di piedini regolabili in altezza

29,4 kg

C45PRO MA	€ 409,00	1	045000232
-----------	----------	---	-----------

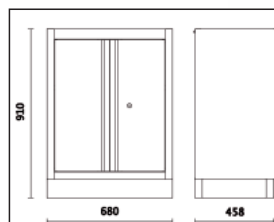

C45PRO MAL

modulo fisso da 1360 mm con 2 antine per arredo officina C45PRO

- Dotato di serratura
- Ripiano interno regolabile in altezza
- Misure interne 670x420 mm
- Dotato di piedini regolabili in altezza

44,8 kg

C45PRO MAL	€ 720,00	1	045000229
------------	----------	---	-----------

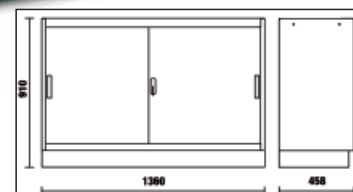

C45PRO MAT

modulo fisso da 1360 mm con 2 antine trasparenti in policarbonato per arredo officina C45PRO

- Dotato di serratura
- Ripiano interno regolabile in altezza
- Misure interne 670x420 mm
- Dotato di piedini regolabili in altezza

📦 44,1 kg

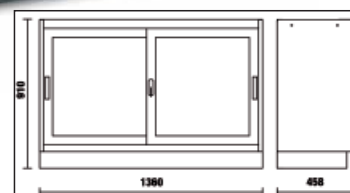

C45PRO MAT

€ 790,00 1 045000230

C45PRO M3A

modulo fisso con 3 cassetti e 2 antine per arredo officina C45PRO

- 3 cassetti da 566x406 mm, montati su guide telescopiche a sfera
- Piano dei cassetti protetto da tappetini di gomma espansa
- Predisposizione per l'inserimento dei termoformati
- Serratura centralizzata frontale
- Vano portaoggetti con doppia antina e serratura (misure interne 670x440 mm), completo di ripiano intermedio
- Dotato di piedini regolabili in altezza

📦 44 kg

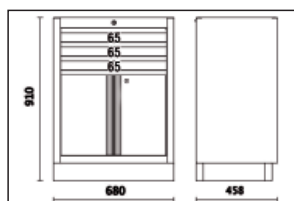
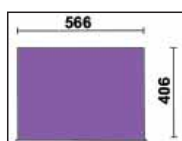
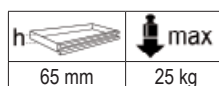

C45PRO M3A

€ 706,00 1 045000231

C45PRO ML

modulo fisso con lavandino integrato per arredo officina C45PRO

Caratteristiche tecniche:

- Vasca in acciaio inossidabile
- Fornito completo di:
 - 1 rubinetto miscelatore
 - 1 gruppo di scarico
 - 1 tappo di chiusura
 - 1 tappo filtro
 - 1 erogatore per sapone

Modulo fisso con due antine dotato di serratura:

- Misure utili interne 600x603x416 mm
- Dotato di piedini regolabili in altezza

📦 44 kg

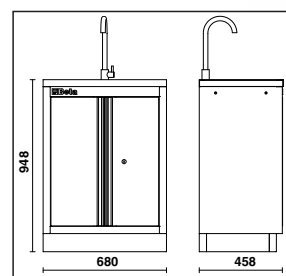

C45PRO ML

€ 1.110,00 1 045000233

C45PRO ACT

modulo fisso con 3 cassetti e 2 arrotolatori integrati per arredo officina C45PRO

- 3 cassetti da 566x406 mm, montati su guide telescopiche a sfera
- Piano dei cassetti protetto da tappetini di gomma espansa
- Serratura centralizzata frontale
- Dotato di piedini regolabili in altezza

Fornito completo di:

- 1 avvolgitubo per aria compressa o acqua fredda integrato da 8 mm, lunghezza 10m art 1900S 8x10
- 1 avvolgitore elettrico integrato, lunghezza 15m, art 1844 15-H05

47 kg

C45PRO ACT € 1.049,00 1 045000247



h	max
65 mm	25 kg
145 mm	30 kg

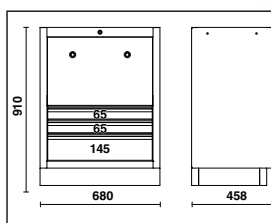
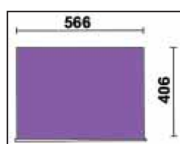

C45PRO TC

modulo fisso per arrotolatori con 3 cassetti per arredo officina C45PRO, vuoto

- 3 cassetti da 566x406 mm, montati su guide telescopiche a sfera
 - Piano dei cassetti protetto da tappetini di gomma espansa
 - Serratura centralizzata frontale
 - Dotato di piedini regolabili in altezza
- Predisposizione per l'inserimento di 2 arrotolatori a scelta tra:
- 2 avvolgitubo per aria compressa o acqua fredda da 8 mm, lunghezza 10m art 1900S 8x10
 - 2 avvolgitore elettrici a scelta tra i seguenti articoli: 1843 15-H05, 1844 10-H05, 1844 15-H05, 1844 15-H07, 1845 12-H05, 1846 10-H05, 1846 10-H07 e 1846 15-H05
 - 1 avvolgitubo per aria compressa o acqua fredda da 8 mm, lunghezza 10m art 1900S 8x10 e 1 avvolgitore elettrico a scelta tra gli articoli sopra elencati

38 kg

C45PRO TC € 642,00 1 045000249

h	max
65 mm	25 kg
145 mm	30 kg

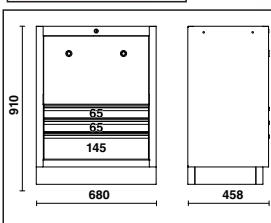
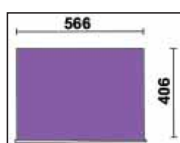

C45PRO T3

carrello a 3 ripiani per arredo officina C45PRO

- Quattro ruote girevoli Ø 100 mm (una con freno)
- Capacità di carico statico: 200 kg. (distribuita sui 3 ripiani)

19,2 kg

C45PRO T3 € 320,00 1 045000250

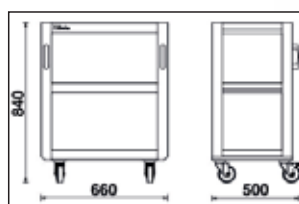

C45PRO SS

staffe laterali per parete tipo stretto per C45PRO

• Misure 1420x32,5x30 mm

1,5 kg



C45PRO SS

€ 31,00 1 045000333

C45PRO SL

staffe laterali per parete tipo largo per C45PRO

• Misure 1420x65x30 mm

2 kg



C45PRO SL

€ 41,50 1 045000366

C45PRO PAS

parete portautensili per arredo officina C45PRO

- Tapparella in alluminio, manovrabile verticalmente, con serratura
- Due pannelli forati amovibili per il sostegno degli utensili
- Abbinabile al banco di lavoro da 1,3 metri

48,8 kg

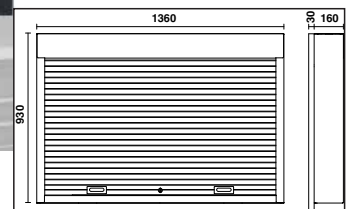

C45PRO PAS

€ 1.038,00 1 045000290

C45PRO PF

pannello forato portautensili per arredo officina C45PRO

• Misure 1052x614,5x24 mm

5,3 kg

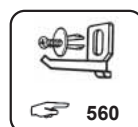

C45PRO PF

€ 128,50 1 045000313

C45PRO PFE

pannello forato portautensili per arredo officina C45PRO

- Misure 1052x614,5x24 mm
- Con predisposizione per 1 presa elettrica (non inclusa)

5,3 kg

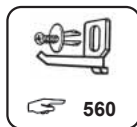

C45PRO PFE

€ 122,00



1

045000312

C45PRO MP

mensola in lamiera per pannelli forati portautensili arredo officina C45PRO

Misure 614x160x80 mm

1,8 kg



C45PRO MP

€ 55,00



1

045000315

C45PRO CORNER/X

angolo completo autoportante per arredo officina C45PRO

- Pensile ad angolo con serratura dotato di molle a gas per facilitare l'apertura e la chiusura dell'anta
- 2 pannelli forati 1052x860 mm per il sostegno degli utensili
- Piano di lavoro angolare in MDF rivestito in acciaio inossidabile da 860 x 860 mm
- Modulo inferiore angolare con ampio vano porta-oggetti
- Dotato di piedini regolabili in altezza

94 kg



C45PRO CORNER/X

€ 2.095,00



1

045000401

Beta

C45PRO CORNER/W

angolo completo autoportante per arredo officina C45PRO

- Pensile ad angolo con serratura dotato di molle a gas per facilitare l'apertura e la chiusura dell'anta
- 2 pannelli forati 1052x860 mm per il sostegno degli utensili
- Piano di lavoro angolare in legno multistrato da 860 x 860 mm
- Modulo inferiore angolare con ampio vano porta-oggetti
- Dotato di piedini regolabili in altezza

📦 93 kg

C45PRO CORNER/W € 2.020,00 1 045000411

C45PRO CAI/X

modulo inferiore angolare per arredo officina C45PRO

- Piano di lavoro angolare in MDF rivestito in acciaio inossidabile da 860x860 mm
- Modulo fisso angolare con ampio vano porta-oggetti
- Dotato di piedini regolabili in altezza

📦 62 kg

C45PRO CAI/X € 1.149,00 1 045000412

C45PRO CAI/W

modulo inferiore angolare per arredo officina C45PRO

- Piano di lavoro angolare in legno multistrato da 860x860 mm
- Modulo fisso angolare con ampio vano porta-oggetti
- Dotato di piedini regolabili in altezza

📦 56 kg

C45PRO CAI/W € 1.075,00 1 045000402

C45PRO PM

pensile a muro per arredo officina C45PRO

- Lunghezza pensile 680 mm
- Dotato di molle a gas per facilitare l'apertura e la chiusura dell'anta
- Con serratura

📦 10 kg

C45PRO PM € 236,50 1 045000302

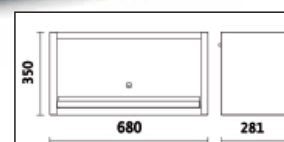

SSPE

supporto sottopensile per elettroutensili

- Applicabile esclusivamente sotto al pensile C45PRO PM (linea d'arredo C45PRO)
- Con 5 pratici slot per alloggiare utensili elettrici
- Dimensioni 680 x 280 x 150 mm

📦 5,4 kg



SSPE

€ 99,00 1 088880482

C45PRO PML

pensile a muro lungo per arredo officina C45PRO

- Lunghezza pensile 1360 mm
- Dotato di molle a gas per facilitare l'apertura e la chiusura dell'anta
- Con serratura

📦 18 kg

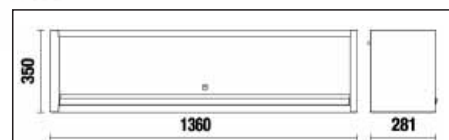

C45PRO PML

€ 423,00 1 045000303

C45PRO AS1

armadio in lamiera a 1 anta con staffa per arredo officina C45PRO

- 4 ripiani amovibili regolabili in altezza
- Pratica barra appendiabiti richiudibile sotto il primo ripiano
- Dotato di serratura
- Misure interne 590x430 mm
- Dotato di piedini regolabili in altezza

📦 57,5 kg

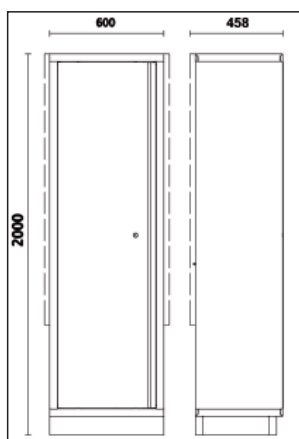

C45PRO AS1

€ 841,00 1 045000451

C45PRO A1/R600

ripiano interno per armadio C45PRO AS1

📦 2,5 kg



C45PRO A1/R600

€ 51,00 1 045000466

C45PRO A1/RB600

ripiano interno per armadio C45PRO AS1 con barra appendiabiti

📏 2,6 kg



C45PRO A1/RB600

€ 59,00 1 045000467

C45PRO AS2

armadio in lamiera a 2 ante con staffa per arredo officina C45PRO

- 4 ripiani amovibili regolabili in altezza
- Dotato di serratura
- Misure interne 910x430 mm
- Dotato di piedini regolabili in altezza

📏 80 kg

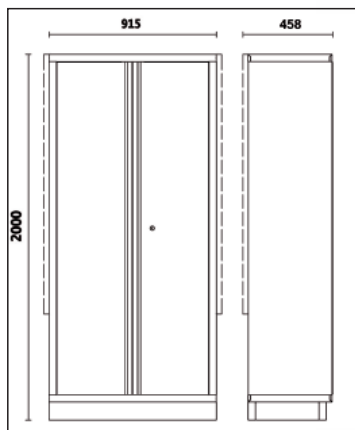

C45PRO AS2

€ 1.119,00 1 045000481

C45PRO A2/R915

ripiano interno per armadio C45PRO AS2

📏 3,7 kg



C45PROA2/R915

€ 63,50 1 045000496

C45STR

nastro adesivo colorato per arredo officina C45PRO

- permette di personalizzare il colore degli inserti orizzontali e verticali dell'arredo officina C45PRO



	L m	€		
C45STR-O/2011	30	66,00	1	045000911
C45STR-G/9006	25	60,00	1	045000912
C45STR-R/3000	25	60,00	1	045000913
C45STR-B/5015	25	60,00	1	045000914
C45STR-Y/1023	25	60,00	1	045000915
C45STR-V/6029	25	60,00	1	045000916

ACCESSORI RSC55 - RSC50 - C45PRO

		5000 RSC50/PLED-ST	5000 RSC50/PLED	5000 RSC50/ASL	5000 RSC50/CTR
	A	1x	-	1x	-
	B	-	1x	1x	1x
	A	1x	1x	1x	-
	B	-	2x	1x	1x
	A	1x	2x	1x	-
	B	-	3x	1x	1x

5000 RSC50/PLED

profilo in alluminio con strip LED per arredo officina RSC50

Da applicare sotto i piani di lavoro, sotto e dentro i pensili, sotto le mensole e i carter lineari/angolari per illuminare le zone di lavoro.

Caratteristiche:

- Strip LED da 6.5W IP20, lunghezza 50 cm
- Fornito completo di due cavi (lunghezza 40cm e 170cm)
- Pratico fissaggio tramite magneti



80 g

5000 RSC50/PLED

€ 37,50 1 050001714

5000 RSC50/PLED-ST

profilo in alluminio con strip LED ed **interruttore SOFT TOUCH** per arredo officina RSC50

Da applicare sotto i piani di lavoro, sotto e dentro i pensili, sotto le mensole e i carter lineari/angolari per illuminare le zone di lavoro.

Caratteristiche:

- Strip LED da 6.5W IP20, lunghezza 50 cm
- **Interruttore SOFT TOUCH** per accensione e regolazione intensità luminosa
- Fornito completo di due cavi (lunghezza 40cm e 170cm)
- Pratico fissaggio tramite magneti



80 g

5000 RSC50/PLED-ST

€ 41,50 1 050001715

5000 RSC50/ASL

alimentatore per strip LED per arredo officina RSC50

Caratteristiche:

- Alimentatore 24VDC 22W
- Può alimentare fino a max. 3 strip LED da 6.5W

200 g



5000 RSC50/ASL

€ 32,50 1 050001716

5000 RSC50/CTR

controller per strip LED, con telecomando RF per arredo officina RSC50

Da utilizzare solo con strip LED art. 5000 RSC50/PLED

Kit composto da:

- 1 mini ricevitore
- 1 telecomando wireless RF

Caratteristiche tecniche mini ricevitore:

Tensione in ingresso: 5V -24VDC
Corrente di uscita nominale: 5A
Corrente di uscita di picco: 12A
Temperatura di utilizzo: da -20 a +35°C

Caratteristiche tecniche telecomando RF:

Tasto ON/OFF
Tasto BRIGHT +/-: permette la regolazione manuale dell'intensità luminosa
Tasto 25%/50%/100%: permette la regolazione automatica dell'intensità luminosa
Batteria: 3V CR2025 (inclusa)
Dimensioni: 86 (L) x 40 (W) x 7 (H) mm

Funzioni integrate:

- Memoria
- Modalità (luminosità manuale/automatica)
- Regolazione luminosità



20 g

5000 RSC50/CTR

€ 16,20 1 050001721

CPMB/3C

contenitori portaminuterie da banco con 3 cassette

- Struttura esterna in PP
- Cassetti portaminuterie in PET
- Impilabili

Caratteristiche tecniche cassette:

- Dimensione interna cassetto mm 160x107x105h
- Infrangibili
- Trasparenza effetto vetro immutata nel tempo
- Antigraffio
- Resistenti ad olii, acidi ed agenti chimici aggressivi
- Idonei per utilizzo anche in ambiente alimentare



2 kg

CPMB/3C

€ 53,50 1 088880443

KIT 6VC/3C

kit 6 vaschette estraibili per contenitori portaminuterie CPMB/3C

1,1 kg



6x



KIT 6VC/3C

€ 29,50 1 088880453

CPMB/5C

contenitori portaminuterie **da banco** con 5 cassetti

- Struttura esterna in PP
- Cassetti portaminuterie in PET
- Impilabili

Caratteristiche tecniche cassetti:

- Dimensione interna cassetto mm 90x86x62h
- Infrangibili
- Trasparenza effetto vetro immutata nel tempo
- Antigraffio
- Resistenti ad olii, acidi ed agenti chimici aggressivi
- Idonei per utilizzo anche in ambiente alimentare

📦 1,5 kg

CPMB/5C € 64,00 1 088880445



KIT 10VC/5C

kit 10 vaschette estraibili per contenitori portaminuterie CPMB/5C

📦 800 g

KIT 10VC/5C € 27,50 1 088880455



10x



PM/5C

portaminuterie **da parete** a 5 vaschette in materiale plastico, con supporto

- Dimensione interna della vaschetta 95x120 mm
- Abbinabile alle pareti portautensili serie C45PRO e RSC55

📦 1,8 kg

PM/5C € 112,50 1 088880450



165
140
600



PM/6C

portaminuterie **da parete** a 6 vaschette in materiale plastico, con supporto

- Dimensione interna della vaschetta 80x60 mm
- Abbinabile alle pareti portautensili serie C45PRO e RSC55

📦 970 g

PM/6C € 86,50 1 088880440



115
95
600



CP

cestino portaflaconi da parete in acciaio

- Abbinabile ai pannelli portautensili da parete

📦 530 g

CP € 109,00 1 088880470



115
95
280



SPC

supporto da parete porta computer

- Abbinabile alle pareti portautensili serie RSC55 e C45PRO
- Dimensioni 398x243x138 mm

📦 1,5 kg



SPC

€ 88,00 1 088880480

SP5S

supporto da parete con 5 scomparti

- Realizzato in lamiera
- 5 vani portautensili con altezze diverse
- Dimensioni 260x60x290 mm

📦 1 kg



SP5S

€ 109,00 1 088880475

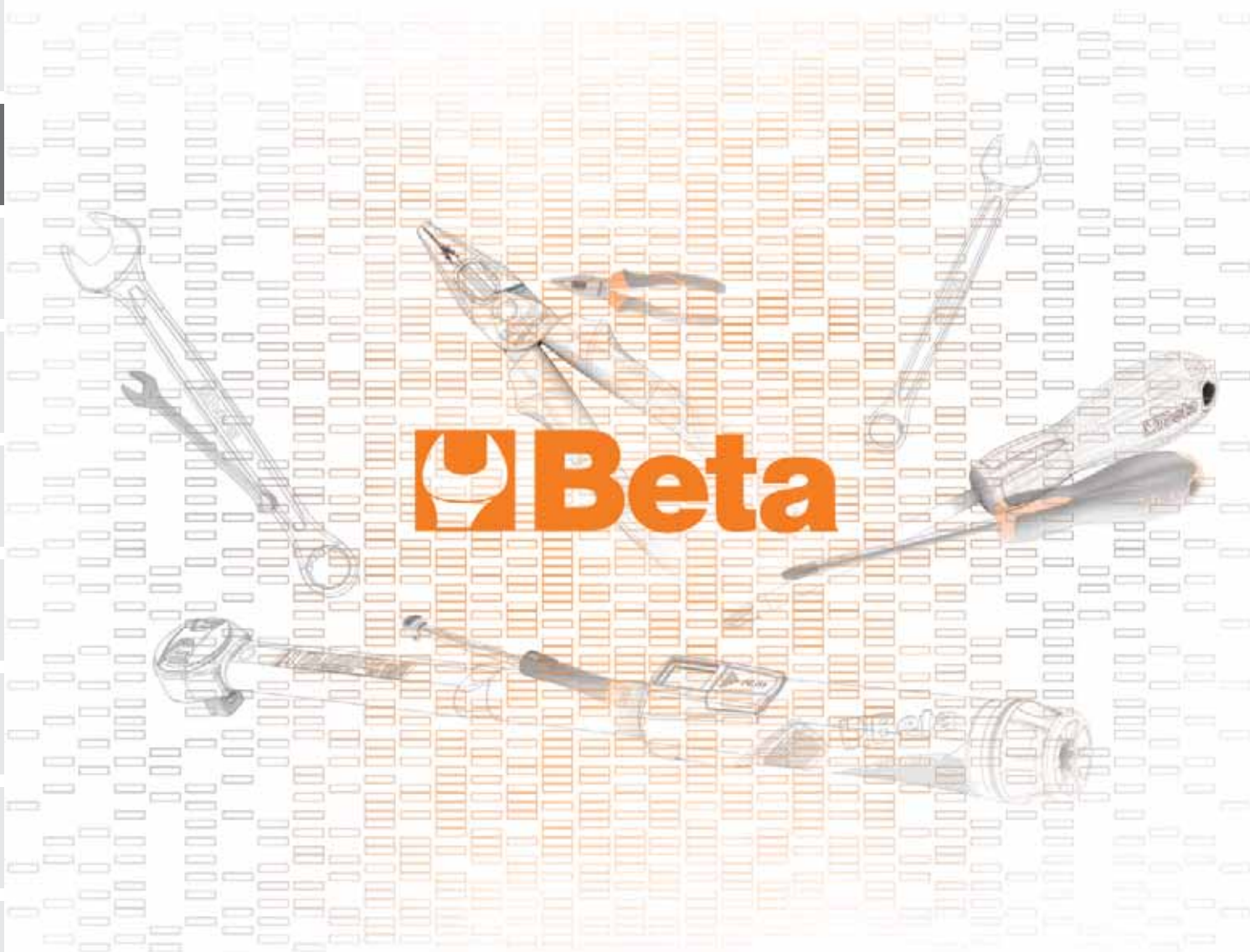

CASSETTIERE E CONTENITORI

		Applicazione	N° pezzi	Cassettiere e Contenitori																
				RSC22	RSC23	RSC23C	RSC23T	RSC24/5	RSC24/6	RSC24/7	RSC24/8	RSC24AXL/9	C25	C27S	RSC28	C30M				
UTENSILI SCIOLTI	Senza supporti	5902MT	Movimento terra	106	☐ 518	☐ 518	☐ 518													
		5902MT/AS	Movimento terra	99	☐ 519	☐ 519	☐ 519													
		5902VI	Manutenzioni industriali	107	☐ 481	☐ 481		☐ 481							☐ 481	☐ 481				
		5904VG/3	Autoriparazione	132					☐ 522	☐ 522	☐ 522	☐ 522								
		5905VG/1	Autoriparazione	94											☐ 525					
		5905VG/2	Autoriparazione	118											☐ 526					
	5910VI/3	Manutenzioni industriali	297																☐ 485	
	Con supporti	5954VG	Autoriparazione	138																
		5954VI	Manutenzioni industriali	133																
		5957U-P	Interventi universali	133																
		5957VG	Autoriparazione	174																
		5957VI	Manutenzioni industriali	162																
	5958U	Interventi universali	85																	
	UTENSILI IN MODULI	Morbidi	5904VG/2M	Autoriparazione	170				☐ 520	☐ 520	☐ 520	☐ 520	☐ 520	☐ 520					☐ 520	
5904VU/1M			Interventi universali	90				☐ 490	☐ 490	☐ 490	☐ 490	☐ 490	☐ 490					☐ 490		
5904VU/2M			Interventi universali	144				☐ 491	☐ 491	☐ 491	☐ 491	☐ 491	☐ 491					☐ 491		
5927VU/M			Interventi universali	108	☐ 501	☐ 501	☐ 501									☐ 501				
5935ET/1MB			Elettrotecnica	96																
5935VG/1MB			Autoriparazione	98																
5935VI/2MB			Manutenzioni industriali	133																
5945VUM			Interventi universali	231																
5988H/7M			Autoriparazione	333									☐ 508	☐ 508					☐ 508	
5988L/4M			Autoriparazione	273					☐ 509	☐ 509	☐ 509	☐ 509	☐ 509	☐ 509						
5980U/BIKE-M		Riparazione biciclette	106									☐ 507	☐ 507					☐ 507		
5988U6/M		Interventi universali	214								☐ 510	☐ 510	☐ 510					☐ 510		
5988U/7M		Interventi universali	215				☐ 497	☐ 497	☐ 497	☐ 497	☐ 497	☐ 497	☐ 497					☐ 497		
5988VHB-MQ		Elettrotecnica	66				☐ 514	☐ 514	☐ 514	☐ 514	☐ 514	☐ 514	☐ 514					☐ 514		
5989 VEM		Autoriparazione	66				☐ 517	☐ 517	☐ 517	☐ 517	☐ 517	☐ 517	☐ 517					☐ 517		
Rigidi		5904VI/1T	Manutenzioni industriali	98				☐ 481	☐ 481	☐ 481	☐ 481	☐ 481	☐ 481	☐ 481					☐ 481	
		5904VI/2T	Manutenzioni industriali	153				☐ 482			☐ 482	☐ 482	☐ 482	☐ 482					☐ 482	
		5904VI/3T	Manutenzioni industriali	142								☐ 483	☐ 483						☐ 483	
	5904VG/2T	Autoriparazione	99				☐ 521	☐ 521	☐ 521	☐ 521	☐ 521	☐ 521	☐ 521					☐ 521		
	5904VG/3T	Autoriparazione	102				☐ 523	☐ 523	☐ 523	☐ 523	☐ 523	☐ 523	☐ 523					☐ 523		
	5904VG/5T	Autoriparazione	153				☐ 524		☐ 524	☐ 524	☐ 524	☐ 524	☐ 524					☐ 524		
	5904VU/2T	Interventi universali	104				☐ 492	☐ 492	☐ 492	☐ 492	☐ 492	☐ 492	☐ 492					☐ 492		
	5904VU/3T	Interventi universali	146				☐ 493	☐ 493	☐ 493	☐ 493	☐ 493	☐ 493	☐ 493					☐ 493		
	5904VU/4T	Interventi universali	197				☐ 494	☐ 494	☐ 494	☐ 494	☐ 494	☐ 494	☐ 494							
	5908VG/2T	Autoriparazione	214																☐ 527	
5908VI/2T	Manutenzioni industriali	232								☐ 484	☐ 484						☐ 484			
5908VU/2T	Interventi universali	161				☐ 495		☐ 495	☐ 495	☐ 495	☐ 495	☐ 495					☐ 495			
5910VI/3T	Manutenzioni industriali	261																	☐ 486	
5938U/2T	Interventi universali	210																		

CASSETTIERE E CONTENITORI

UTENSILI SCIOLTI

UTENSILI IN MODULI

	Applicazione	N° pezzi	C35	C38	C39MD C39SM	C39T	C45PRO	RSC51	C54S RSC55C	RSC55	RSC55PS RSC55PSE	RSC50	C57SA C57SB C57SC		C57SD	C57SP	C58P	C45PRO PAS	C59A C59C	C59B	
													C57SA	C57SB							
Senza supporti	5902MT	Movimento terra	106			518															
	5902MT/AS	Movimento terra	99			519															
	5902VI	Manutenzioni industriali	107																		
	5904VG/3	Autoriparazione	132							522		522							522	522	
	5905VG/1	Autoriparazione	94																		
	5905VG/2	Autoriparazione	118																		
	5910VI/3	Manutenzioni industriali	297																		
	5954VG	Autoriparazione	138							531											
	5954VI	Manutenzioni industriali	133							489	489										
	5957U-P	Interventi universali	133									503	503	503							
	5957VG	Autoriparazione	174									532		532							
	5957VI	Manutenzioni industriali	162											488							
5958U	Interventi universali	85					504			504	504						504				
Morbidi	5904VG/2M	Autoriparazione	170		520	520				520									520	520	
	5904VU/1M	Interventi universali	90		490	490		490		490									490	490	
	5904VU/2M	Interventi universali	144		491	491				491									491	491	
	5927VU/M	Interventi universali	108																		
	5935ET/1MB	Elettrotecnica	96	511																	
	5935VG/1MB	Autoriparazione	98	528																	
	5935VI/2MB	Manutenzioni industriali	133	487																	
	5945VUM	Interventi universali	231		530			530													
	5988H/7M	Autoriparazione	333								508										469
	5988L/4M	Autoriparazione	273		470	470					470								470	470	
	5980U/BIKE-M	Riparazione biciclette	106																		
	5988U6/M	Interventi universali	214		510						510										510
	5988U/7M	Interventi universali	215		497						497								497	497	
	5988VHB-MQ	Elettrotecnica	66		514	514		514		514									514	514	
	5989 VEM	Autoriparazione	66																		
	Rigidi	5904VI/1T	Manutenzioni industriali	98		481	481		481		481									481	481
		5904VI/2T	Manutenzioni industriali	153		482					482									482	482
5904VI/3T		Manutenzioni industriali	142		483					483										483	
5904VG/2T		Autoriparazione	99		521	521		521		521									521	521	
5904VG/3T		Autoriparazione	102		523	523				523									523	523	
5904VG/5T		Autoriparazione	153		524					524									524	524	
5904VU/2T		Interventi universali	104		492	492				492									492	492	
5904VU/3T		Interventi universali	146		493	493				493									493	493	
5904VU/4T		Interventi universali	197		494	494				494									494	494	
5908VG/2T		Autoriparazione	214																		
5908VI/2T		Manutenzioni industriali	232																		484
5908VU/2T		Interventi universali	161		495					495									495	495	
5910VI/3T		Manutenzioni industriali	261																		
5938U/2T		Interventi universali	210		502																



5902VI assortimento di 107 utensili

► Manutenzioni industriali

N. pezzi/Descrizione

- 6 cacciaspina Ø 2 - 3 - 4 - 5 - 6 - 8 mm
- 1 bulino Ø 3 mm
- 1 scalpelli piatti nervati 200 mm
- 26 serie di chiavi combinate 6x32 mm
- 12 chiavi a forchetta 6x7 - 8x9 - 10x11 - 12x13 - 14x15 - 16x17 - 18x19 - 20x22 - 21x23 - 24x26 - 25x28 - 30x32 mm
- 9 chiavi maschio esagonale piegate Ø 1,5 - 2 - 2,5 - 3 - 4 - 5 - 6 - 8 - 10 mm
- 1 chiave regolabile a rullino 300 mm
- 13 chiavi a bussola esagonali 1/2" con guida Ø 10÷22 mm
- 1 prolunga - 1/2" 125 mm
- 1 prolunga - 1/2" 255 mm
- 1 snodo 1/2"
- 1 quadro maschio 1/2" con spina scorrevole
- 1 cricchetto reversibile 1/2" @
- 1 pinze regolabili cerniera chiusa 250 mm
- 1 pinza autobloccante 240 mm
- 1 tronchesi a grande effetto, a taglienti diagonali, finitura industriale 160 mm
- 1 cesoia a doppia leva dritta 250 mm
- 1 forbici per elettricisti lame dritte
- 1 pinze universali a grande effetto, finitura industriale = 180 mm
- 1 pinze a becchi mezzotondi lunghissimi, diritti zigrinati, impugnatura bimatereale, finitura industriale ● 160 mm
- 8 giravite lama piatta ● 2,5x50 - 3x75 - 3,5x100 - 4x125 - 5,5x125 - 6,5x150 - 8x200 - 10x200 mm
- 4 giravite per viti con impronta a croce Phillips® ● PH0x60 - PH1x80 - PH2x100 - PH3x150 mm
- 1 martello tipo tedesco 500 g
- 1 mazzuola antirimbazzo Ø 40 mm
- 1 punta per tracciare
- 1 flessometro 5 m
- 1 spessimetro
- 5 serie di 5 lime 200 mm
- 1 seghetto
- 1 oliatore in metallo a pressione 300 cc
- 1 cutter con lama a settori
- 1 lampada magnetica snodata con LED ad alta luminosità

Beta N.
31
32
35
42/S26
55/S12
96N/SC9
111E
920A/SB13
920/21
920/22
920/25
920/42
920/55
1048N
1052
1084GBM
1122
1128BMX
1150GBM
1166GBM
1260
1262
1370
1392
1688A
1692
1708/20
1719BMA...S5
1726BM
1751N
1771BM
1837F

5902VI

€ 1.750,00 059021060

Assortimento consigliato in abbinamento con RSC22 - RSC23 - RSC23T - C25 - C27S



5904VI/1T assortimento di 98 utensili in termoformato rigido in ABS

► Manutenzioni industriali

N. pezzi/Descrizione

- 19 chiavi a bussola esagonali 1/2" Ø 10÷24 - 26 - 27 - 30 - 32 mm
- 5 chiavi a bussola maschio esagonale 1/2" Ø 5 - 6 - 8 - 10 - 12 mm
- 1 prolunga - 1/2" 125 mm
- 1 prolunga - 1/2" 255 mm
- 1 snodo 1/2"
- 1 quadro maschio 1/2" con spina scorrevole
- 1 cricchetto reversibile 1/2" @
- 16 chiavi combinate 6÷21 mm
- 5 chiavi combinate 22-24-27-30-32 mm
- 1 pinze regolabili cerniera chiusa 250 mm
- 1 pinza autobloccante 240 mm
- 1 tronchesi a grande effetto taglienti diagonali 160 mm
- 1 pinza universale = 180 mm
- 1 pinza a becchi mezzotondi diritti ● 160 mm
- 1 pinze becchi diritti per anelli elastici, per fori Ø 180 mm
- 1 pinze becchi piegati per anelli elastici, per fori Ø 170 mm
- 1 pinze becchi diritti per anelli elastici, per alberi ● 175 mm
- 1 pinze becchi piegati per anelli elastici, per alberi ● 175 mm
- 2 scalpelli piatti nervati 100 - 200 mm
- 5 lime a taglio mezzodolce 200 mm
- 1 martello tipo tedesco 300 g
- 1 mazzuola con battenti in materiale plastico Ø 35 mm
- 8 chiavi a forchetta 6x7 - 8x9 - 10x11 - 12x13 - 14x15 - 16x17 - 18x19 - 20x22 mm
- 9 chiavi maschio esagonale piegate Ø 1,5 - 2 - 2,5 - 3 - 4 - 5 - 6 - 8 - 10 mm
- 4 giravite lama piatta ● 3x75 - 4x100 - 5,5x150 - 6,5x150 mm
- 3 giravite per viti con impronta a croce Phillips® ● PH0x60 - PH1x80 - PH2x100 mm
- 6 chiavi a T maschio esagonale 2,5 - 3 - 4 - 5 - 6 - 8 mm

Beta N.	TR
920A	T80
920ME	T80
920/21	T80
920/22	T80
920/25	T80
920/42	T80
920/55	T80
42	T05
42	T06
1048N	T153
1052	T153
1084	T138
1150	T138
1166	T138
1032	T145
1034	T145
1036	T145
1038	T145
35	T234
1719BMA8/S5	T236
1370	T234
1390	T234
55	T33
96/SC9	T33
1260	T208
1262	T208
951	T68

5904VI/1T

€ 1.590,00 059041161

Assortimento consigliato in abbinamento con RSC23T - RSC24 - RSC24A - RSC24L/7 - RSC24L-CAB - RSC24AXL - RSC24AXLP/7 - RSC28 - C37 - C39 - C39MD - C39SM - C39T - RSC51 - RSC55 - RSC50 - C59

5904VI/2T

assortimento di 153 utensili in termoformato rigido in ABS

► Manutenzioni industriali

N. pezzi/Descrizione

- 16 chiavi combinate 6÷21 mm
- 5 chiavi combinate 22 - 24 - 27 - 30 - 32 mm
- 5 cacciapina Ø 2 - 3 - 4 - 5 - 6 mm
- 1 bulino Ø 4 mm
- 12 chiavi a forchetta 6x7 - 8x9 - 10x11 - 12x13 - 14x15 - 16x17
18x19 - 20x22 - 21x23 - 24x26 - 27x29 - 30x32 mm
- 9 chiavi maschio esagonale piegate ○ 1,5 - 2 - 2,5 - 3 - 4 - 5 - 6 - 8 - 10 mm
- 7 chiavi poligonali curve 6÷29 mm
- 19 chiavi a bussola esagonali 1/2" ○ 10÷24 - 26 - 27 - 30 - 32 mm
- 1 prolunga - 1/2" 125 mm
- 1 prolunga - 1/2" 255 mm
- 1 snodo 1/2"
- 1 quadro maschio 1/2" con spina scorrevole
- 1 cricchetto reversibile 1/2" Ⓢ
- 13 chiavi a bussola esagonali 1/4" ○ 4÷14 mm
- 6 chiavi a bussola maschio esagonale 1/4" ○ 2,5÷8 mm
- 1 prolunga - 1/4" 50 mm
- 1 prolunga - 1/4" 150 mm
- 1 snodo 1/4"
- 1 quadro con impugnatura 1/4"
- 1 quadro scorrevole 1/4"
- 1 cricchetto reversibile 1/4" Ⓢ
- 9 giravite lama piatta ● 3x75 - 3x100 - 4x100 - 4x150 - 5,5x100
5,5x150 - 6,5x150 - 8x150 - 10x200 mm
- 2 giravite nano lama piatta ● 4x30 - 6,5x30 mm
- 7 giravite per viti con impronta a croce Phillips® Ⓢ PH0x60 - PH0x100 - PH1x80 - PH1x120
- PH2x100 - PH2x150 - PH3x150 mm
- 2 giravite nano Phillips® Ⓢ PH1x30 - PH2x30 mm
- 1 pinze regolabili cerniera chiusa 250 mm
- 1 pinza autobloccante 240 mm
- 1 tronchesi a grande effetto taglienti diagonali ⚡ 160 mm
- 1 pinza a becchi mezzotondi dritti ● 160 mm
- 1 pinza universale = 180 mm
- 1 pinze becchi dritti per anelli elastici, per fori ○ 180 mm
- 1 pinze becchi piegati per anelli elastici, per fori ○ 170 mm
- 1 pinze becchi dritti per anelli elastici, per alberi ● 175 mm
- 1 pinze becchi piegati per anelli elastici, per alberi ● 175 mm
- 6 chiavi a T maschio esagonale 2,5 - 3 - 4 - 5 - 6 - 8 mm
- 5 lime a taglio mezzodolce 200 mm
- 2 scalpelli piatti nervati 100 - 200 mm
- 1 martello tipo tedesco 300 g
- 1 mazzuola con battenti in materiale plastico Ø 35 mm
- 1 rivettrice
- 100 rivetti 2,9x6 mm
- 100 rivetti 3,2x8 mm
- 100 rivetti 3,8x10 mm
- 100 rivetti 4x12 mm
- 100 rivetti 4,8x12 mm
- 1 flessometro
- 1 miniseghetto
- 1 10 lame a settori 18 mm per cutter 1771, 1771BM e 1771HD
- 1 cutter con lama a settori

Beta N.	TR
42	T05
42	T06
31	T31
32	T31
55	T31
96N/SC9	T31
90	T40
920A	T83
920/21	T83
920/22	T83
920/25	T83
920/42	T83
920/55	T83
900	T91
900ME	T91
900/20	T91
900/21	T91
900/25	T91
900BG/30	T91
900/42	T91
900/55	T91
1260	T167
1260N	T167
1262	T168
1262N	T168
1048N	T153
1052	T153
1084	T138
1166	T138
1150	T138
1032	T145
1034	T145
1036	T145
1038	T145
951	T68
1719BMA8/S5	T236
35	T234
1370	T234
1390	T234
1741B	T281
1741RV...K	T281
1741RV...K	T281
1741RV...K	T281
1741RV...K	T281
1741RV...K	T281
1692	T294
1725CR	T294
1771RL	T294
1771	T294



T05 T06 T31



T40 T83 T91



T167 T168



T153 T138 T145 T68



T236 T234 T281 T294



5904VI/2T

2.250,00 059041164

Assortimento consigliato in abbinamento con RSC23T - RSC24 da 7-8 cassette - RSC24A da 7-8 cassette - RSC24AXL - RSC24AXLP7 - RSC24L/7 - RSC24L-CAB - RSC28 - C37 da 7-8 cassette - C39 da 7-8 cassette - C39MD - C39SM - C59 - RSC55 - RSC50

5904VI/3T

assortimento di 142 utensili in termoformato rigido in ABS

► Manutenzioni industriali

N. pezzi/Descrizione

Beta N. TR



T05 T06 T31

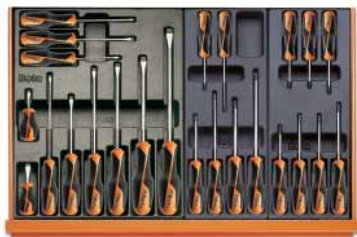

T167 T202 T205



T80 T73 T68



T137 T153 T145 T146



T231 T297 T281



T279 VP6

- 16 chiavi combinate 6÷21 mm
- 5 chiavi combinate 22 - 24 - 27 - 30 - 32 mm
- 5 cacciaspina Ø 2 - 3 - 4 - 5 - 6 mm
- 1 bulino Ø 4 mm
- 12 chiavi a forchetta 6x7 - 8x9 - 10x11 - 12x13 - 14x15 - 16x17 - 18x19 - 20x22 - 21x23 - 24x26 - 27x29 - 30x32 mm
- 9 chiavi maschio esagonale piegate Ø 1,5 - 2 - 2,5 - 3 - 4 - 5 - 6 - 8 - 10 mm
- 9 giravite lama piatta ● 3x75 - 3,5x100 - 4x100 - 4x150 - 5,5x100 - 5,5x150 - 6,5x150 - 8x150 - 10x200 mm
- 2 giravite nano lama piatta ● 4x30 - 6,5x30 mm
- 6 giravite per viti con impronta a croce Phillips® ⚙ PH0x60 - PH0x100 - PH1x80 - PH1x120 - PH2x100 - PH2x150 mm
- 7 chiave maschio per viti con impronta Torx® ⚙ T6-T7-T8-T9-T10-T15-T20
- 5 chiavi a bussola maschio esagonale 1/2" ○ 5 - 6 - 8 - 10 - 12 mm
- 1 prolunga - 1/2" 125 mm
- 1 prolunga - 1/2" 255 mm
- 1 snodo 1/2"
- 1 quadro maschio 1/2" con spina scorrevole
- 1 cricchetto reversibile 1/2" ⚙
- 19 chiavi a bussola esagonali 1/2" ○ 10÷24 - 26 - 27 - 30 - 32 mm
- 8 chiavi a tubo doppie poligonali 6x7 - 8x9 - 10x11 - 12x13 - 14x15 - 16x17 - 18x19 - 20x22 mm
- 1 spine di manovra per chiavi a tubo 1 - 2
- 1 spine di manovra per chiavi a tubo 1 - 2
- 6 chiavi a T maschio esagonale 2,5 - 3 - 4 - 5 - 6 - 8 mm
- 1 pinza universale ■ 180 mm
- 1 pinza a becchi mezzotondi dritti ● 160 mm
- 1 tronchesi a grande effetto taglienti diagonali ✂ 160 mm
- 1 pinze regolabili cerniera chiusa 250 mm
- 1 pinza autobloccante 240 mm
- 1 pinze becchi dritti per anelli elastici, per fori ○ 180 mm
- 1 pinze becchi piegati per anelli elastici, per fori ○ 170 mm
- 1 pinze becchi dritti per anelli elastici, per alberi ● 175 mm
- 1 pinze becchi piegati per anelli elastici, per alberi ● 175 mm
- 1 pinze becchi dritti per anelli elastici, per fori ○ 140 mm
- 1 pinze becchi piegati per anelli elastici, per fori ○ 225 mm
- 1 pinze becchi dritti per anelli elastici, per alberi ● 140 mm
- 1 pinze becchi piegati per anelli elastici, per alberi ● 225 mm
- 1 martello tipo tedesco 400 g
- 1 mazzuola con battenti in materiale plastico Ø 35 mm
- 1 lime a taglio mezzodolce 200 mm
- 1 lime a taglio mezzodolce 200 mm
- 1 lime a taglio mezzodolce 200 mm
- 1 calibro digitale a corsoio
- 1 riga flessibile graduata 300 mm
- 1 flessometro 5 m
- 1 rivettatrice 250 mm
- 100 rivetti 2,9x6 mm
- 100 rivetti 3,2x8 mm
- 100 rivetti 3,8x10 mm
- 100 rivetti 4x12 mm
- 100 rivetti 4,8x12 mm
- 1 cesoia a lame larghe diritte 250 mm
- 1 forbici per elettricisti lame dritte
- 1 seghetto
- (5) lame per seghetti
- 1 oliatore in metallo a pressione 200 cc termoformato vuoto

42	T05
42	T06
31	T31
32	T31
55	T31
96N/SC9	T31
1260	T167
1260N	T167
1262	T202
1267TX	T205
920ME	T80
920/21	T80
920/22	T80
920/25	T80
920/42	T80
920/55	T80
920A	T80
930	T73
940/1	T73
940/2	T73
951	T68
1150BM	T137
1166BM	T137
1084BM	T137
1048N	T153
1052	T153
1032	T145
1034	T145
1036	T145
1038	T145
1032	T146
1034	T146
1036	T146
1038	T146
1370	T231
1390	T231
1719BMA8/T	T231
1719BMA8/P	T231
1719BMA8/M	T231
1651DGTB	T297
1682	T297
1691BM	T297
1741B	T281
1741RV..K	T281
1741RV..K	T281
1741RV..K	T281
1741RV..K	T281
1741RV..K	T281
1112	T279
1128BM	T279
1726	T279
1728BM	T279
1751N	T279
VP6	VP6

5904VI/3T

€ 2.580,00 059041168

Assortimento consigliato in abbinamento con RSC24 da 8 cassette - RSC24A da 8 cassette - RSC24AXL da 8-9 cassette - RSC24AXLP/7 - RSC28 - C37 da 8 cassette - C39 da 8 cassette - C39MD - C39SM - RSC35 - RSC50 - C59B

5908VI/2T

assortimento di 232 utensili in termoformato rigido in ABS

► Manutenzioni industriali

N. pezzi/Descrizione



T80 T05 T06



T91 T68 T40 T41



T199 T202 T201 T204



T234 T281 T153 T236



T145 T137 T31



T279 VP5



T273 T270

- 5 chiavi a bussola maschio esagonale 1/2" \bigcirc 5 - 6 - 8 - 10 - 12 mm
- 1 prolunga - 1/2" 125 mm
- 1 prolunga - 1/2" 255 mm
- 1 snodo 1/2"
- 1 quadro maschio 1/2" con spina scorrevole
- 1 cricchetto reversibile 1/2" $\text{\textcircled{R}}$
- 19 chiavi a bussola esagonali 1/2" \bigcirc 10+24 - 26 - 27 - 30 - 32 mm
- 16 chiavi combinate 6+21 mm
- 5 chiavi combinate 22 - 24 - 27 - 30 - 32 mm
- 13 chiavi a bussola esagonali 1/4" \bigcirc 4+14 mm
- 6 chiavi a bussola maschio esagonale 1/4" \bigcirc 2,5 - 3 - 4 - 5 - 6 - 8 mm
- 1 prolunga - 1/4" 50 mm
- 1 prolunga - 1/4" 150 mm
- 1 quadro con impugnatura 1/4"
- 1 snodo 1/4"
- 1 quadro scorrevole 1/4"
- 1 cricchetto reversibile 1/4" $\text{\textcircled{R}}$
- 6 chiavi a T maschio esagonale 2,5 - 3 - 4 - 5 - 6 - 8 mm
- 7 chiavi poligonali curve 6x7-8x9-10x11-12x13-14x15-16x17-18x19 mm
- 5 chiavi poligonali curve 20x22 - 21x23 - 24x26 - 25x28 - 27x29 mm
- 7 giravite lama piatta \bullet 2,5x50 - 3x75 - 3,5x100 - 4x125 - 5,5x100 - 5,5x150 - 6,5x150 mm
- 6 giravite per viti con impronta a croce Phillips $\text{\textcircled{P}}$ PH0x60 - PH0x100 - PH1x80 - PH1x120 - PH2x100 - PH2x150 mm
- 3 giravite lama piatta \bullet 8x200 - 10x150 - 10x200 mm
- 2 giravite nano lama piatta \bullet 4x30 - 6,5x30 mm
- 2 giravite per viti con impronta a croce Phillips $\text{\textcircled{P}}$ PH3x150 - PH4x200 mm
- 2 giraviti nano Phillips $\text{\textcircled{P}}$ PH1x30 - PH2x30 mm
- 2 scalpelli piatti nervati 100 - 200 mm
- 1 martello tipo tedesco 300 g
- 1 mazzuola con battenti in materiale plastico \varnothing 35 mm
- 1 rivettatrice 250 mm
- 100 rivetti 2,9x6 mm
- 100 rivetti 3,2x8 mm
- 100 rivetti 3,8x10 mm
- 100 rivetti 4x12 mm
- 100 rivetti 4,8x12 mm
- 1 pinze regolabili cerniera chiusa 250 mm
- 1 pinza autobloccante 240 mm
- 5 serie di 5 lime 200 mm
- 1 pinze becchi diritti per anelli elastici, per fori \bigcirc 180 mm
- 1 pinze becchi piegati per anelli elastici, per fori \bigcirc 170 mm
- 1 pinze becchi diritti per anelli elastici, per alberi \bullet 175 mm
- 1 pinze becchi piegati per anelli elastici, per alberi \bullet 175 mm
- 1 pinza universale = 180 mm
- 1 pinza a becchi mezzotondi diritti \bullet 160 mm
- 1 tronchese a grande effetto taglienti diagonali ∇ 160 mm
- 5 cacciaspina \varnothing 2 - 3 - 4 - 5 - 6 mm
- 1 bulino \varnothing 4 mm
- 12 chiavi a forchetta 6x7 - 8x9 - 10x11 - 12x13 - 14x15 - 16x17 - 18x19 - 20x22 - 21x23 - 24x26 - 27x29 - 30x32 mm
- 9 chiavi maschio esagonale piegate \bigcirc 1,5 - 2 - 2,5 - 3 - 4 - 5 - 6 - 8 - 10 mm
- 1 cesoia a lame larghe dritte 250 mm
- 1 forbici per elettricisti lame dritte
- 1 seghetto
- 5 lame per seghetti
- 1 oliatore in metallo a pressione 200 cc
- 1 termoformato vuoto
- 1 giramaschi regolabile M3+M12
- 1 giramaschi regolabile M5+M21
- 1 giramaschi a cricchetto reversibile 2,0+5,0 mm (M3+M8)
- 1 giramaschi a cricchetto reversibile 4,6+8,0 mm (M5+M12)
- 1 girafilere 25,4 mm
- 1 girafilere 38,1 mm
- 1 contafiletti 0,25+6 W 62+4x1"
- 26 maschi a mano passo grosso M3 - 4 - 5 - 6 - 7 - 8 - 9 - 10 - 12 - 14 - 16 - 18 - 20
- 14 maschi a mano passo fine M6x0,75 - M8x1 - M10x1,25
- M12x1,5 - M14x1,5 - M16x1,5 - M18x1,5
- 7 filiere tonde passo grosso M3 - 4 - 5 - 6 - 7 - 8 - 9
- 6 filiere tonde passo grosso M10 - 12 - 14 - 16 - 18 - 20
- 2 filiere tonde passo fine M6x0,75 - M8x0,75
- 5 filiere tonde passo fine M10x1,25 - M12x1,5 - M14x1,5 - M16x1,5 - M18x1,5

Beta N.	TR
920ME	T80
920/21	T80
920/22	T80
920/25	T80
920/42	T80
920/55	T80
920A	T80
42	T05
42	T06
900	T91
900ME	T91
900/20	T91
900/21	T91
900B/G/30	T91
900/25	T91
900/42	T91
900/55	T91
951	T68
90	T40
90	T41
1260	T199
1262	T202
1260	T201
1260N	T201
1262	T204
1262N	T204
35	T234
1370	T234
1390	T234
1741B	T281
1741RV...K	T281
1741RV...K	T281
1741RV...K	T281
1741RV...K	T281
1741RV...K	T281
1048N	T153
1052	T153
1719BMA...S5	T236
1032	T145
1034	T145
1036	T145
1038	T145
1150BM	T137
1166BM	T137
1084BM	T137
31	T31
32	T31
55	T31
96N/SC9	T31
1112	T279
1128BM	T279
1726	T279
1728BM	T279
1751N	T279
VP5	VP5
435/1,5	T273
435/3	T273
436/1	T273
436/2	T273
444/1	T273
444/2	T273
1707	T273
430	T270
433	T270
440	T270
440A	T270
441	T270
441A	T270

5908VI/2T

€ 3.410,00 059081105

Assortimento consigliato in abbinamento con RSC28 - RSC24/8 - RSC24A/8 - RSC24AXL da 8 e 9 cassetti - C37/8 - C39/8 - RSC55 - RSC50 - C59B

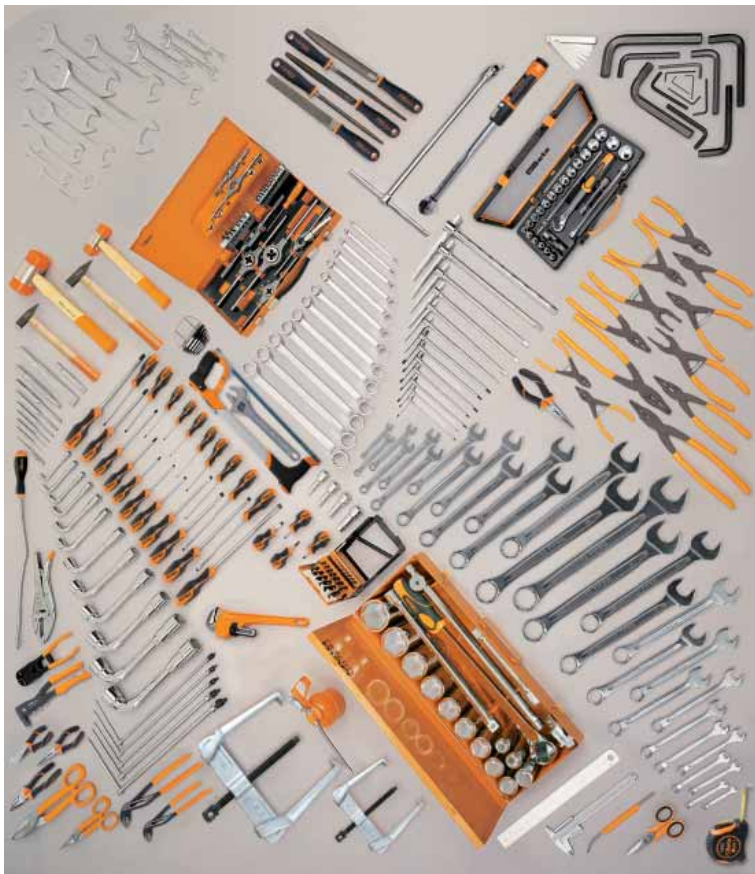

5910VI/3

assortimento di 297 utensili

► Manutenzioni industriali

N. pezzi/Descrizione	Beta N.
6 cacciaspina Ø 2 - 3 - 4 - 5 - 6 - 8 mm	31/B6N
1 bulino Ø 4 mm	32
2 scalpelli piatti nervati 125 - 250 mm	35
1 ugnetto nervato 200 mm	37
30 chiavi combinate 6-7-8-9-10-11-12-13-14-15-16-17-18-19-20-21-22-23-24-25-26-27-28-29-30-32-35-36-38-41 mm	42
14 chiavi a forchetta 6x7 - 8x9 - 10x11 - 12x13 - 14x15 - 16x17 - 18x19 - 20x22 - 21x23 - 24x26 - 25x28 - 27x29 - 30x32 - 36x41 mm	55
13 chiavi poligonali curve 6x7+30x32 mm	90
14 chiavi maschio esagonale piegate Ø 1,5 - 2 - 2,5 - 3 - 4 - 5 - 6 - 8 - 10 - 12 - 13 - 14 - 17 - 19 mm	96N
1 chiave regolabile a rullino 250 mm	111E
1 giratubi modello americano 300 mm	362
25 punte elicoidali cilindriche, serie corta 1+13x0,5 mm	412/SP25
37 assortimento di maschi e filiere in acciaio HSS	447/C37
1 chiavi dinamometriche a scatto ZERO-RESET Ⓞ 1/2", 40+200 Nm	666/20
1 quadro maschio a T snodato 1/2"	920/40
4 chiavi a bussola maschio esagonale 1/2" Ⓞ 10-12-14-17 mm	920ME
20 chiavi a bussola e 5 accessori	920A/C20X
17 assortimento di 12 chiavi a bussola e 5 accessori 3/4"	928A/C12
12 chiavi a pipa doppie esagonali - poligonali 8 - 10 - 11 - 13 - 14 - 17 - 19 - 22 - 24 - 27 - 30 - 32 mm	932
14 chiavi a T maschio esagonale 2+14 mm	951/S14
5 chiavi a T con maschio esagonale snodato Ⓞ 3 - 4 - 5 - 6 - 8 mm	953
3 pinze becchi dritti per anelli elastici, per fori Ⓞ 180 - 225 - 300 mm	1032
3 pinze becchi piegati per anelli elastici, per fori Ⓞ 170 - 210 - 290 mm	1034
3 pinze becchi dritti per anelli elastici, per alberi ● 140x1,3 - 175 - 225 mm	1036
3 pinze becchi piegati per anelli elastici, per alberi ● 135x1,3 - 175 - 220 mm	1038
2 pinze regolabili cerniera chiusa 250 - 300 mm	1048N
1 pinza autobloccante a doppia regolazione	1051
1 tronchesi a grande effetto, a taglianti diagonali, finitura industriale ⚡ 160 mm	1084GBM
1 tronchesi doppia leva taglio frontale ⚡ 180 mm	1092V
1 cesoia a lame larghe diritte 300 mm	1112
1 cesoia a lame strette diritte 250 mm	1114
1 forbici per elettricisti lame diritte	1128BMX
1 pinze universali a grande effetto, finitura industriale ≡ 180 mm	1150GBM
1 pinze a becchi mezzotondi lunghissimi, dritti zigrinati, impugnatura bimatereale, finitura industriale ● 160 mm	1166GBM
1 pinze a becchi mezzotondi lunghissimi, piegati zigrinati, impugnatura bimatereale, finitura industriale ● 160 mm	1168GBM
9 giravite lama piatta ● 2,5x50 - 3x75 - 3,5x150 - 4x125 - 5,5x125 - 6,5x150 - 8x200 - 10x200 - 12x250 mm	1260
2 giravite nano lama piatta ● 4x30 - 6,5x30 mm	1260N
5 giravite per viti con impronta a croce Phillips® Ⓞ PH0x100 - PH1x120 - PH2x150 - PH3x150 - PH4x200 mm	1262
2 giraviti nano Phillips® Ⓞ PH1x30 - PH2x30 mm	1262N
7 chiave maschio per viti con impronta Torx® Ⓞ T6 - T8 - T10 - T15 - T20 - T25 - T30	1267TX
2 martello tipo tedesco 300 - 600 g	1370
2 mazzuola con battenti in materiale plastico Ø 35 - 60 mm	1390
5 estrattori conici M3+M18	1430/S5
1 estrattore universale a due griffe 23+70 mm	1500N/1
1 estrattore universale a due griffe 23+100 mm	1500N/2
1 calibro a corsoio	1650
1 riga semirigida 300 mm	1683
1 punta per tracciare	1688A
1 flessometro 5 m	1692
1 spessimetro	1708/13
1 flessibile magnetico 1,8 kg	1712E/2
5 lime a taglio mezzodolce 200 mm	1719BMA8/S5
1 seghetto	1726BM
1 rivettatrice	1741B
1 oliatore in metallo a pressione 200 cc	1751N



5910VI/3

7.110,00 059101044

Assortimento consigliato in abbinamento con C30M

5910VI/3T

assortimento di 261 utensili in termoformato rigido in ABS

► Manutenzioni industriali

N. pezzi/Descrizione

- 16 chiavi combinate 6÷21 mm
- 5 chiavi combinate 22 - 24 - 27 - 30 - 32 mm
- 5 cacciapina Ø 2 - 3 - 4 - 5 - 6 mm
- 1 bulino Ø 4 mm
- 13 chiavi a forchetta 6x7 - 8x9 - 10x11 - 12x13 - 14x15 - 16x17
18x19 - 20x22 - 21x23 - 24x26 - 27x29 - 30x32 mm
- 9 chiavi maschio esagonale piegate Ø 1,5 - 2 - 2,5 - 3 - 4 - 5 - 6 - 8 - 10 mm
- 5 chiavi poligonali curve 20x22 - 21x23 - 24x26 - 25x28 - 27x29 mm
- 7 chiavi poligonali curve 6x7 - 8x9 - 10x11 - 12x13 - 14x15 - 16x17 - 18x19 mm
- 5 chiavi a bussola maschio esagonale 1/2" Ø 5 - 6 - 8 - 10 - 12 mm
- 1 prolunga - 1/2" 125 mm
- 1 prolunga - 1/2" 255 mm
- 1 snodo 1/2"
- 1 quadro maschio 1/2" con spina scorrevole
- 1 cricchetto reversibile 1/2" Ⓢ
- 19 chiavi a bussola esagonali 1/2" Ø 10+24 - 26 - 27 - 30 - 32 mm
- 9 giravite lama piatta ● 3x75 - 3x100 - 4x100 - 4x150 - 5,5x100 - 5,5x150 - 6,5x150 - 8x150 - 10x200 mm
- 2 giravite nano lama piatta ● 4x30 - 6,5x30 mm
- 7 giravite per viti con impronta a croce Phillips® Ⓢ PH0x60 - PH0x100 - PH1x80 - PH1x120 - PH2x100 - PH2x150 - PH3x150 mm
- 2 giraviti nano Phillips® Ⓢ PH1x30 - PH2x30 mm
- 4 chiavi maschio esagonale piegate Ø 13-14-17-19 mm
- 1 cesoia a lame larghe diritte 250 mm
- 1 forbici per elettricisti lame dritte
- 1 seghetto
- (5) lame per seghetti
- 1 oliatore in metallo a pressione 200 cc
- 1 pinza universale = 180 mm
- 1 pinza a becchi mezzotondi dritti ● 160 mm
- 1 tronchesi a grande effetto taglienti diagonali ⚡ 160 mm
- 1 pinze becchi dritti per anelli elastici, per fori Ø 180 mm
- 1 pinze becchi piegati per anelli elastici, per fori Ø 170 mm
- 1 pinze becchi dritti per anelli elastici, per alberi ● 175mm
- 1 pinze becchi piegati per anelli elastici, per alberi ● 175mm
- 2 scalpelli piatti nervati 100 - 200 mm
- 1 martello tipo tedesco 300 g
- 1 mazzuola con battenti in materiale plastico Ø 35 mm
- 1 lime a taglio mezzodolce 200 mm
- 4 chiavi combinate 35-36-38-41 mm
- 1 chiavi a forchetta 36x41 mm
- 1 chiave regolabile a rullino 250 mm
- 1 giratubi modello americano 300 mm
- 25 punte elicoidali cilindriche, serie corta
- 37 assortimento di maschi e filiere in acciaio HSS
- 1 chiavi dinamometriche a scatto ZERO-RESET Ⓢ 40÷200 Nm
- 17 assortimento di 12 chiavi a bussola e 5 accessori 3/4"
- 14 chiavi a T maschio esagonale
- 5 chiavi a T con maschio esagonale snodato Ø 3-4-5-6-8 mm
- 1 pinze becchi dritti per anelli elastici, per fori Ø 300 mm
- 1 pinze becchi piegati per anelli elastici, per fori Ø 290 mm
- 1 pinze becchi dritti per anelli elastici, per alberi ● 225 mm
- 1 pinze becchi piegati per anelli elastici, per alberi ● 220 mm
- 1 pinze regolabili cerniera chiusa 300 mm
- 1 pinza autobloccante a doppia regolazione
- 1 tronchesi doppia leva taglio frontale ⚡ 180 mm
- 1 martello tipo tedesco 600 g
- 1 mazzuola con battenti in materiale plastico 60 mm
- 5 estrattori conici M3-M18
- 1 estrattore universale a due griffe
- 1 calibro a corsoio
- 1 riga semirigida
- 1 punta per tracciare
- 1 flessometro 5 m
- 1 spessimetro
- 1 flessibile magnetico

Beta N.	TR
42	T05
42	T06
31	T31
32	T31
55	T31
96N/SC9	T31
90	T41
90	T40
920ME	T80
920/21	T80
920/22	T80
920/25	T80
920/42	T80
920/55	T80
920A	T80
1260	T167
1260N	T167
1262	T168
1262N	T168
96N	T168
1112	T279
1128BM	T279
1726	T279
1728BM	T279
1751N	T279
1150BM	T137
1166BM	T137
1084BM	T137
1032	T145
1034	T145
1036	T145
1038	T145
35	T234
1370	T234
1390	T234
1719BMA8/S5	T236
42	
55	
111E	
362	
412/SP25	
447/C37	
666/20	
928A/C12	
951/S14	
953	
1032	
1034	
1036	
1038	
1048N	
1051	
1092V	
1370	
1390	
1430/S5	
1500/3	
1650	
1683	
1688	
1692	
1708/13	
1712E/2	



T05 T06 T31



T40 T41 T80



T167 T168 +96N



T279
T137 T145 T234 T236



5910VI/3T € 6.070,00 059101063

Assortimento consigliato in abbinamento con C30M

5935VI/2MB

assortimento di 133 utensili per cassettera C35, in vassoio morbido in EVA

► Manutenzioni industriali

N. pezzi/Descrizione

- 21 chiavi combinate 6-7-8-9-10-11-12-13-14-15-16-17-18-19-20-21-22-24-27-30-32 mm
- 8 chiavi a forchetta 6x7-8x9-10x11-12x13-14x15
16x17-18x19-20x22 mm
- 1 pinze regolabili cerniera chiusa 250 mm
- 19 chiavi a bussola esagonali 1/2" \odot 10-11-12-13-14-15-16-17-18
19-20-21-22-23-24-26-27-30-32 mm
- 1 prolunga angolare - 1/2" 125 mm
- 1 prolunga angolare - 1/2" 150 mm
- 1 snodo 1/2"
- 1 quadro maschio 1/2" con spina scorrevole
- 1 cricchetto reversibile 1/2" \oplus
- 1 chiave regolabile a rullino 250 mm
- 1 pinza autobloccante 240 mm
- 1 tronchesi a grande effetto taglienti diagonali ∇ 160 mm
- 1 pinza universale \equiv 180 mm
- 1 pinza a becchi mezzotondi dritti \bullet 160 mm
- 1 pinze becchi dritti per anelli elastici, per fori \odot 180 mm
- 1 pinze becchi piegati per anelli elastici, per fori \odot 170 mm
- 1 pinze becchi dritti per anelli elastici, per alberi \bullet 175 mm
- 1 pinze becchi piegati per anelli elastici, per alberi \bullet 175 mm
- 13 chiavi a bussola esagonali 1/4" \odot 4-4,5-5-5,5-6-7-8-9-10-11-12-13-14 mm
- 1 prolunga - 1/4" 50 mm
- 1 prolunga - 1/4" 150 mm
- 1 snodo 1/4"
- 1 quadro con impugnatura 1/4"
- 1 cricchetto reversibile 1/4" \oplus
- 1 quadro scorrevole 1/4"
- 7 giravite lama piatta \bullet 2,5x50-3x75-3,5x100-4x100-5,5x125-6,5x150-8x200 mm
- 2 giravite nano lama piatta \bullet 4x30-6,5x30 mm
- 7 giravite per viti con impronta a croce Phillips® \oplus PH0x60-PH0x100-PH1x80-PH1x120-
PH2x100-PH2x150-PH3x150 mm
- 2 giraviti nano Phillips® \oplus PH1x30-PH2x30 mm
- 1 giravite cercafase \bullet 4x30-6,5x30 mm
- 9 chiavi maschio esagonale piegate con estremità sferica \odot
- 6 chiavi a T maschio esagonale 2,5-3-4-5-6-8 mm
- 5 cacciaspina \emptyset 2-3-4-5-6 mm
- 1 bulino \emptyset 4 mm
- 1 scalpelli piatti nervati 200 mm
- 1 cesoia a lame larghe diritte 250 mm
- 1 forbici per elettricisti lame diritte
- 1 martello tipo tedesco 500 g
- 1 mazzuola con battenti in materiale plastico \emptyset 45 mm
- 1 lima 200 mm
- 1 lima 200 mm
- 1 lima 200 mm
- 1 lima 200 mm
- 1 lima 200 mm
- 1 seghetto 440 mm

Beta N.	TR
42	MB12
55	MB12
1048N	MB12
920A	MB37
920AN/125	MB37
920AN/250	MB37
920/25	MB37
920/42	MB37
920/55	MB37
111E	MB37
1052	MB37
1084BM	MB37
1150BM	MB37
1166BM	MB37
1032	MB37
1034	MB37
1036	MB37
1038	MB37
900	MB37
900/20	MB37
900/21	MB37
900/25	MB37
900BG/30	MB37
900/55	MB37
900/42	MB37
1260	MB44
1260N	MB44
1262	MB44
1262N	MB44
1253	MB44
96BPC/SC9	MB44
951	MB44
31	MB55
32	MB55
35	MB55
1112	MB55
1128BMX	MB55
1370	MB55
1390	MB55
1719BMA..Q	MB55
1719BMA..T	MB55
1719BMA..P	MB55
1719BMA..M	MB55
1719BMA..R	MB55
1726	MB55



MB12



MB37



MB44



MB55

5935VI/2MB

2.345,00



059351316

Assortimento consigliato in abbinamento con C35



5957VI

assortimento di 162 utensili - accessori di fissaggio inclusi

► Manutenzioni industriali

N. pezzi/Descrizione	Beta N.
6 cacciaspina Ø 2 - 3 - 4 - 5 - 6 - 8 mm	31/SP6
6 punzoni, 1 bulino, 3 scalpelli con supporto	38/SP6
18 chiavi combinate 6-7-8-10-11-12-13-14-15-16-17-19-21-22-24-27-30-32 mm	42
12 chiavi a forchetta 6x7 ÷ 30x32 mm	55/S12X
8 chiavi maschio esagonale con impugnatura 2 - 2,5 - 3 - 4 - 5 - 6 - 8 - 10 mm	96T/S8
8 chiavi maschio piegate per viti con impronta Torx®	97TX/SC8
⊕ T9 - T10 - T15 - T20 - T25 - T27 - T30 - T40	
1 chiave regolabile a rullino 250 mm	111E
13 chiavi a bussola poligonali 1/2" con guida ⌀ 10÷22 mm	920B/SB13
8 chiavi a bussola poligonali 1/2" con guida ⌀ 23÷32 mm	920B/SB8
4 chiavi a bussola a giravite lama piatta 1/2" ⌀ 1,2x6,5 - 1,2x8 - 1,6x9 - 2x12 mm	920LP
3 chiavi a bussola a giravite lama Phillips® 1/2" ⊕ PH2 - 3 - 4	920PH
1 prolunga - 1/2" 125 mm	920/21
1 prolunga - 1/2" 255 mm	920/22
1 snodo 1/2"	920/25
1 quadro maschio 1/2" con spina scorrevole	920/42
1 cricchetto reversibile 1/2" ⊕	920/55
1 leva con estremità a punta e piatta curva	963
2 pinze becchi dritti per anelli elastici, per fori ⌀ 140 - 180 mm	1032
2 pinze becchi piegati per anelli elastici, per fori ⌀ 130 - 170 mm	1034
2 pinze becchi dritti per anelli elastici, per alberi ⌀ 140 - 175 mm	1036
2 pinze becchi piegati per anelli elastici, per alberi ⌀ 135 - 175 mm	1038
1 pinza regolabili cerniera chiusa 250 mm	1048N
1 pinza autobloccante a doppia regolazione	1051
1 tronchese a grande effetto taglienti diagonali 160 mm	1084BM
1 tronchese doppia leva taglio frontale 180 mm	1092V
1 cesoia a lame larghe diritte 250 mm	1112
1 cesoia a lame strette diritte 250 mm	1114
1 forbici per elettricisti lame diritte	1128BMX
1 pinza universale 180 mm	1150BM
1 pinza a becchi mezzotondi dritti ⌀ 160 mm	1166BM
1 pinza a becchi mezzotondi piegati ⌀ 160 mm	1168BM
7 giravite lama piatta ⌀ 2,5x50 - 3x75 - 4x100 - 5,5x125 - 6,5x150 - 8x200 - 10x200 mm	1260
4 giravite per viti con impronta a croce Phillips® ⊕ PH0x60 - PH1x80 - PH2x100 - PH3x150 mm	1262
3 martello tipo tedesco 300 - 600 - 1000 g	1370
1 mazzuola con battenti in materiale plastico Ø 35 mm	1390
1 flessometro 5 m	1692
1 flessibile magnetico 1,8 kg	1712E/2
1 raschietto a due taglienti 200 mm	1717A
1 raschietto a tre taglienti 200 mm	1717B
5 lime a taglio mezzodolce 200 mm	1719BMA8/S5
1 seghetto	1725
1 oliatore in metallo a pressione 200 cc	1751
1 scalpelli piatti nervati 200 mm	35
1 ugnetto nervato 200 mm	37
11 chiavi a pipa doppie esagonali - poligonali 8 - 10 - 11 - 12 - 13 - 14 - 16 - 17 - 19 - 22 - 24 mm	932
1 pinza autobloccante 240 mm	1052
1 pinza autobloccante 280 mm	1060
1 pinza autobloccante 290 mm	1062
1 mazzuola antirimbalo Ø 50 mm	1392
1 estrattore universale a due griffe 25÷130 mm	1500N/2
1 calibro a corsoio	1650
1 riga semirigida 300 mm	1683
1 punta per tracciare	1688A
1 spessimetro	1708/13
1 coltello a serramanico	1777BM
1 cutter con lama a settori 170 mm	1771BM
1 tronchese a taglienti diagonali 160 mm	1082BM



5957VI 3.610,00 059571005

Assortimento consigliato in abbinamento con C57SA - C57SB - C57SP



5954VI

assortimento di 133 utensili - accessori di fissaggio inclusi

► Manutenzioni industriali

N. pezzi/Descrizione	Beta N.
5 cacciaspina Ø 2-3-4-5-6 mm	31
1 bulino Ø 4 mm	32
2 scalpelli piatti nervati 200-250 mm	35
18 chiavi combinate 6+14 - 16 - 17 - 18 - 19 - 21 - 22 - 24 - 27 - 30 mm	42
12 chiavi a forchetta 6x7 - 8x9 - 10x11 - 12x13 - 14x15 - 16x17	55
18x19 - 20x22 - 21x23 - 24x26 - 27x29 - 30x32 mm	
12 chiavi maschio esagonale piegate Ø 2÷10 mm	96/SC12
1 chiave regolabile a rullino 250 mm	111E
1 giratubi svedese 320 mm	374
20 chiavi a bussola esagonali 1/2" Ø 10÷24 - 26 - 27 - 28 - 30 - 32 mm	920A
6 chiavi a bussola maschio esagonale 1/2" Ø 5 - 6 - 8 - 10 - 12 - 14 mm	920ME
1 prolunga - 1/2" 125 mm	920/21
1 prolunga - 1/2" 255 mm	920/22
1 snodo 1/2"	920/25
1 quadro maschio a T snodato 1/2"	920/40
1 quadro maschio 1/2" con spina scorrevole	920/42
1 cricchetto reversibile 1/2" ®	920/55
6 chiavi a T maschio esagonale 2,5 - 3 - 4 - 5 - 6 - 8 mm	951
2 pinze becchi dritti per anelli elastici, per fori Ø 140 - 180 mm	1032
1 pinze becchi piegati per anelli elastici, per fori Ø 170 mm	1034
2 pinze becchi dritti per anelli elastici, per alberi Ø 140x1,3 - 175 mm	1036
1 pinze becchi piegati per anelli elastici, per alberi Ø 175 mm	1038
1 pinze regolabili cerniera chiusa 250 mm	1048N
1 pinza autobloccante 240 mm	1052
1 tronchesi a grande effetto taglianti diagonali ≤ 160 mm	1084BM
1 tronchesi doppia leva taglio frontale ≤ 180 mm	1092V
1 cesoia a lame larghe diritte 250 mm	1112
1 forbici per elettricisti lame diritte	1128BMX
1 pinza universale = 180 mm	1150BM
1 pinza a becchi mezzotondi dritti Ø 160 mm	1166BM
1 giravite cercafase ●	1253
2 giravite lama piatta ● 8x150 - 10x200 mm	1260
2 giravite nano lama piatta ● 4x30 - 6,5x30 mm	1260N
2 giravite per viti con impronta a croce Phillips®	1262
⊕ PH3x150 - PH4x200 mm	
2 giraviti nano Phillips® ⊕ PH1x30 - PH2x30 mm	1262N
8 giravite	1263/D8
2 martello tipo tedesco 300 - 500 g	1370
1 mazzuola con battenti in materiale plastico Ø 45 mm	1390
1 flessometro 5 m	1692
1 flessibile magnetico 0,5 kg	1712E/1
5 lime a taglio mezzodolce 200 mm	1719BMA8/SS
1 seghetto	1726BM
1 oliatore in plastica a pressione 250 cc	1754



5954VI

2.465,00 059541053

Assortimento consigliato in abbinamento con C54S



5904VU/1M

assortimento di 90 utensili in vassoio morbido in EVA

► Universali

N. pezzi/Descrizione

- 16 chiavi combinate 6÷21 mm
- 8 chiavi a forchetta 6x7 - 8x9 - 10x11 - 12x13 - 14x15 - 16x17
18x19 - 20x22 mm
- 9 chiavi maschio esagonale piegate \odot 1,5 - 2 - 2,5 - 3 - 4 - 5 - 6 - 8 - 10 mm
- 6 chiave maschio per viti con impronta Torx® \odot T8-T10-T15-T20-T25-T30
- 3 giravite lama piatta \bullet 3x75-4x100-6,5x150 mm
- 3 giravite per viti con impronta a croce Phillips® \oplus PH0x60-PH1x80-PH2x100 mm
- 8 chiavi maschio esagonale con impugnatura \odot 2-2,5-3-4-5-6-7-8 mm
- 1 prolunga angolare - 1/2" 125 mm
- 1 prolunga angolare - 1/2" 250 mm
- 1 snodo 1/2"
- 1 quadro maschio 1/2" con spina scorrevole
- 1 cricchetto reversibile 1/2" \otimes
- 19 chiavi a bussola esagonali 1/2" \odot 10÷24 - 26 - 27 - 30 - 32 mm
- 1 tronchesi a grande effetto taglienti diagonali ∇ 160 mm
- 1 pinza universale \equiv 180 mm
- 1 pinza a becchi mezzotondi dritti \bullet 160 mm
- 1 pinze regolabili cerniera chiusa 250 mm
- 1 pinza autobloccante 240 mm
- 2 scalpelli piatti nervati 100 - 200 mm
- 1 martello tipo tedesco 300 g
- 1 mazzuola con battenti in materiale plastico \varnothing 35 mm
- 1 pinze becchi dritti per anelli elastici, per fori \odot 180 mm
- 1 pinze becchi piegati per anelli elastici, per fori \odot 170 mm
- 1 pinze becchi dritti per anelli elastici, per alberi \bullet 175 mm
- 1 pinze becchi piegati per anelli elastici, per alberi \bullet 175 mm

Beta N.	TR
42	M05
55	M33
96/SC9	M33
1267TX	M204
1260	M201
1262	M201
96T	M50
920AN/125	M83
920AN/250	M83
920/25	M83
920/42	M83
920/55	M83
920A	M83
1084	M137
1150	M137
1166	M137
1048N	M153
1052	M153
35	M234
1370	M234
1390	M234
1032	M145
1034	M145
1036	M145
1038	M145

M05 M33 M204 M201

M50 M83

M137 M153 M234 M145



5904VU/1M

1.430,00 059041201

Assortimento consigliato in abbinamento con RSC23T - RSC24 - RSC24A - RSC24AXL - RSC24AXLP/7 - RSC24L/7 - RSC24L-CAB
RSC28 - C37 - C39 - C39T - C39SM - C39MD - RSC51 - RSC55 - RSC50 - C59

5904VU/2M

assortimento di 144 utensili in vassoio morbido in EVA

► Universali

N. pezzi/Descrizione

- 16 chiavi combinate 6÷21 mm
- 8 chiavi a forchetta 6x7 - 8x9 - 10x11 - 12x13 - 14x15 - 16x17 - 18x19 - 20x22 mm
- 9 chiavi maschio esagonale piegate \odot 1,5 - 2 - 2,5 - 3 - 4 - 5 - 6 - 8 - 10 mm
- 3 giravite lama piatta \bullet 3x75-4x100-6,5x150 mm
- 3 giravite per viti con impronta a croce Phillips® \oplus PH0x60-PH1x80-PH2x100 mm
- 6 chiave maschio per viti con impronta Torx® \otimes T8-T10-T15-T20-T25-T30
- 8 chiavi maschio esagonale con impugnatura \odot 2-2,5-3-4-5-6-7-8 mm
- 1 prolunga angolare - 1/2" 125 mm
- 1 prolunga angolare - 1/2" 250 mm
- 1 snodo 1/2"
- 1 quadro maschio 1/2" con spina scorrevole
- 1 cricchetto reversibile 1/2" \oplus
- 19 chiavi a bussola esagonali 1/2" \odot 10÷24 - 26 - 27 - 30 - 32 mm
- 1 tronchesi a grande effetto taglienti diagonali \nlessgtr 160 mm
- 1 pinza universale \equiv 180 mm
- 1 pinza a becchi mezzotondi dritti \bullet 160 mm
- 1 pinze regolabili cerniera chiusa 250 mm
- 1 pinza autobloccante 240 mm
- 2 scalpelli piatti nervati 100 - 200 mm
- 1 martello tipo tedesco 300 g
- 1 mazzuola \emptyset 35 mm
- 1 pinze becchi dritti per anelli elastici, per fori \odot 180 mm
- 1 pinze becchi piegati per anelli elastici, per fori \odot 170 mm
- 1 pinze becchi dritti per anelli elastici, per alberi \bullet 175 mm
- 1 pinze becchi piegati per anelli elastici, per alberi \bullet 175 mm
- 1 termoformato morbido con 3 vaschette portaminuterie
- 1 flessometro 5 m
- 1 miniseghetto
- 1 10 lame a settori 18 mm per cutter 1771, 1771BM e 1771HD
- 1 cutter con lama a settori
- 5 inserti colorati per avvitatori per viti a testa con intaglio \bullet 0,5x3 - 0,6x4,5 - 0,8x5,5 - 1x5,5 - 1,2x6,5 mm
- 8 inserti colorati maschio esagonale per avvitatori \odot 2 - 2,5 - 3 - 4 - 5 - 6 - 8 - 10 mm
- 5 inserti colorati per avvitatori per viti con impronta a croce Phillips® \oplus PH0 - PH1 - PH2 - PH3 - PH4
- 4 inserti colorati per avvitatori per viti con impronta a croce Pozidriv® - Supadriv® \oplus PZ1 - PZ2 - PZ3 - PZ4
- 11 inserti colorati per avvitatori per viti con impronta Torx® \otimes T6-T7-T8-T9-T10-T15-T20-T25-T27-T30-T40
- 8 inserti colorati per avvitatori per viti con impronta Tamper Resistant Torx® \oplus T9-T10-T15-T20-T25-T27-T30-T40
- 1 portainseriti a sgancio rapido con impugnatura 230 mm
- 1 cricchetto reversibile portainseriti 100 mm
- 5 lime a taglio mezzodolce 200 mm
- 1 raccordi per avvitatori
- 1 prolunga portainseriti magnetica

Beta N.	TR
42	M05
55	M33
96/SC9	M33
1260	M201
1262	M201
1267TX	M204
96T	M50
920AN/125	M83
920AN/250	M83
920/25	M83
920/42	M83
920/55	M83
920A	M83
1084	M137
1150	M137
1166	M137
1048N	M153
1052	M153
35	M237
1370T	M237
1390N	M237
1032	M145
1034	M145
1036	M145
1038	M145
VPM3	VPM3
1692	M294
1725CR	M294
1771RL	M294
1771	M294
860LP	M85
860PE	M85
860PH	M85
860PZ	M85
860TX	M85
860RTX	M85
851SR	M85
860/55	M85
1719BMA8/S5	M236
8920	M85
882P	M85



5904VU/2M

1.860,00 059041212

Assortimento consigliato in abbinamento con RSC23T - RSC24 - RSC24A - RSC24AXL - RSC24AXLP/7 - RSC24L/7 - RSC24L-CAB RSC28 - C37 - C39 - C39SM - C39MD - C39T - RSC55 - RSC50 - C59

5904VU/2T

assortimento di 104 utensili in termoformato rigido in ABS

► Universali

N. pezzi/Descrizione

Beta N.	TR
1260	T199
1262	T202
920A	T83
920/21	T83
920/22	T83
920/25	T83
920/42	T83
920/55	T83
1032	T145
1034	T145
1036	T145
1038	T145
1048N	T153
1052	T153
1084	T138
1150	T138
1166	T138
35	T234
1390	T234
951	T68
55	T33
96/SC9	T33
42	T05
42	T06
1128BMX	T284
1130BMX	T284
1719BMA...Q	T284
1719BMA...P	T284
1719BMA...T	T284
1719BMA...M	T284
1719BMA...R	T284
1726BM	T284
1728BM	T284
1771BM	T284
1778V18	T284



T199 T202 T83



T145 T153 T138 T234



T68 T33 T05 T06



T284

- 7 giravite lama piatta ● 2,5x50 - 3x75 - 3,5x100 - 4x125
5,5x100 - 5,5x150 - 6,5x150 mm
- 6 giravite per viti con impronta a croce Phillips® ⊕ PH0x60 - PH0x100 - PH1x80 - PH1x120 - PH2x100 - PH2x150 mm
- 19 chiavi a bussola esagonali 1/2" ○ 10-11-12-13-14-15-16-17-18-19
20-21-22-23-24-26-27-30-32 mm
- 1 prolunga - 1/2" 125 mm
- 1 prolunga - 1/2" 255 mm
- 1 snodo 1/2"
- 1 quadro maschio 1/2" con spina scorrevole 305 mm
- 1 cricchetto reversibile 1/2" ⊗
- 1 pinze becchi dritti per anelli elastici, per fori ○ 180 mm
- 1 pinze becchi piegati per anelli elastici, per fori ○ 170 mm
- 1 pinze becchi dritti per anelli elastici, per alberi ● 175 mm
- 1 pinze becchi piegati per anelli elastici, per alberi ● 175 mm
- 1 pinze regolabili cerniera chiusa 250 mm
- 1 pinza autobloccante 240 mm
- 1 tronchesi a grande effetto taglienti diagonali ⚡ 160 mm
- 1 pinza universale = 180 mm
- 1 pinza a becchi mezzotondi dritti ● 160 mm
- 2 scalpelli piatti nervati 100-200 mm
- 1 martello tipo tedesco 300 g
- 1 mazzuola con battenti in materiale plastico Ø 35 mm
- 6 chiavi a T maschio esagonale 2,5-3-4-5-6-8 mm
- 8 chiavi a forchetta 6x7-8x9-10x11-12x13-14x15
16x17-18x19-20x22 mm
- 9 chiavi maschio esagonale piegate ○ 1,5+10 mm
- 16 chiavi combinate 6-7-8-9-10-11-12-13-14-15-16-17
18-19-20-21 mm
- 5 chiavi combinate 22-24-27-30-32 mm
- 1 forbici per elettricisti lame diritte
- 1 forbici multiuso
- 1 lima 200 mm
- 1 lima 200 mm
- 1 lima 200 mm
- 1 lima 200 mm
- 1 lima 200 mm
- 1 lima 200 mm
- 1 seghetto
- 1 lame per seghetti
- 1 cutter con lama a settori 170 mm
- 1 185 mm

5904VU/2T € 1.715,00 059041070

Assortimento consigliato in abbinamento con RSC23T - RSC24 - RSC24A - RSC24AXL - RSC24AXLP/7 - RSC24L/7 - RSC24L-CAB - RSC28 - C37 - C39 - C39SM - C39MD - C39T RSC55 - RSC50 - C59

5904VU/3T

assortimento di 146 utensili in termoformato rigido in ABS

► Universali

N. pezzi/Descrizione

- 16 chiavi combinate 6÷21 mm
- 5 chiavi combinate 22 - 24 - 27 - 30 - 32 mm
- 5 cacciaspina Ø 2 - 3 - 4 - 5 - 6 mm
- 1 bulino Ø 4 mm
- 12 chiavi a forchetta 6x7 - 8x9 - 10x11 - 12x13 - 14x15 - 16x17 - 18x19 - 20x22 - 21x23 - 24x26 - 27x29 - 30x32 mm
- 9 chiavi maschio esagonale piegate ○ 1,5 - 2 - 2,5 - 3 - 4 - 5 - 6 - 8 - 10 mm
- 6 chiavi maschio esagonale con impugnatura ○ 2 - 2,5 - 3 - 4 - 5 - 6 mm
- 6 chiavi maschio con impugnatura per viti con impronta Torx® ⊕ T10-T15-T20-T25-T27-T30
- 5 chiavi a bussola maschio esagonale 1/2" ○ 5 - 6 - 8 - 10 - 12 mm
- 1 prolunga - 1/2" 125 mm
- 1 prolunga - 1/2" 255 mm
- 1 snodo 1/2"
- 1 quadro maschio 1/2" con spina scorrevole
- 1 cricchetto reversibile 1/2" ⊕
- 19 chiavi a bussola esagonali 1/2" ○ 10÷24 - 26 - 27 - 30 - 32 mm
- 13 chiavi a bussola esagonali 1/4" ○ 4-4,5-5-5,5-6-7-8-9-10-11-12-13-14 mm
- 6 chiavi a bussola maschio esagonale 1/4" ○ 2,5-3-4-5-6-8 mm
- 1 prolunga - 1/4" 50 mm
- 1 prolunga - 1/4" 150 mm
- 1 snodo 1/4"
- 1 quadro con impugnatura 1/4"
- 1 quadro scorrevole 1/4" 115 mm
- 1 cricchetto reversibile 1/4" ⊕
- 1 pinze becchi dritti per anelli elastici, per fori ○ 180 mm
- 1 pinze becchi piegati per anelli elastici, per fori ○ 170 mm
- 1 pinze becchi dritti per anelli elastici, per alberi ● 175 mm
- 1 pinze becchi piegati per anelli elastici, per alberi ● 175 mm
- 1 pinza universale = 180 mm
- 1 pinza a becchi mezzotondi dritti ● 160 mm
- 1 tronchesi a grande effetto taglienti diagonali ⚡ 160 mm
- 1 pinze regolabili cerniera chiusa 250 mm
- 1 pinza autobloccante 240 mm
- 4 giravite lama piatta ● 3x75 - 4x100 - 5,5x150 - 6,5x150 mm
- 3 giravite per viti con impronta a croce Pozidriv®-Supadriv® ⊕ PZ0 - PZ1 - PZ2
- 7 chiave maschio per viti con impronta Torx® ⊕ T6-T7-T8-T9-T10-T15-T20
- 2 scalpelli piatti nervati 100 - 200 mm
- 1 martello tipo tedesco 300 g
- 1 mazzuola con battenti in materiale plastico Ø 35 mm
- 5 lime a taglio mezzodolce 200 mm

Beta N.	TR
42	T05
42	T06
31	T31
32	T31
55	T31
96N/SC9	T31
96T	T52
97TTX	T55
920ME	T80
920/21	T80
920/22	T80
920/25	T80
920/42	T80
920/55	T80
920A	T80
900	T91
900ME	T91
900/20	T91
900/21	T91
900/25	T91
900BG/30	T91
900/42	T91
900/55	T91
1032	T145
1034	T145
1036	T145
1038	T145
1150	T138
1166	T138
1084	T138
1048N	T153
1052	T153
1260	T198
1269PZ	T198
1267TX	T205
35	T234
1370	T234
1390	T234
1719BMA8/S5	T236



T05 T06 T31



T52 T55 T80



T91 T145 T138 T153



T198 T205 T234 T236

5904VU/3T

€ 2.075,00 059041203

Assortimento consigliato in abbinamento con RSC23T - RSC24 - RSC24A - RSC24AXL - RSC24AXLP/7 - RSC24L/7 - RSC24L-CAB - C37 - C39 - C39T - C39SM - C39MD - RSC55 - RSC50 - C59

5904VU/4T

assortimento di 197 utensili in termoformato rigido in ABS

► Universali

N. pezzi/Descrizione

- 1 punzoni Ø 4 mm
- 1 cacciaspina Ø 4 mm
- 1 bulino Ø 4 mm
- 54 Assortimento di 52 inserti con attacco esagonale 10 mm e 2 accessori
- 17 chiavi combinate 6-7-8-10-11-12-13-14-16-17-18-19-21-22-24-27-30 mm
- 7 chiavi poligonali curve 6x7-8x9-10x11-12x13-14x15-16x17-18x19 mm
- 19 chiavi a bussola esagonali 1/2" ○ 10-11-12-13-14-15-16-17-18-19-20-21-22-23-24-26-27-30-32 mm
- 1 prolunga - 1/2" 125 mm
- 1 prolunga - 1/2" 250 mm
- 1 snodo 1/2"
- 1 quadro maschio 1/2" con spina scorrevole 305 mm
- 1 cricchetto reversibile 1/2" Ⓢ
- 13 chiavi a bussola esagonali 1/4" ○ 4-4,5-5-5,5-6-7-8-9-10-11-12-13-14 mm
- 6 chiavi a bussola maschio esagonale 1/4" ○ 2,5-3-4-5-6-8 mm
- 1 prolunga - 1/4" 50 mm
- 1 prolunga - 1/4" 150 mm
- 1 snodo 1/4"
- 1 quadro con impugnatura 1/4"
- 1 quadro scorrevole 1/4" 115 mm
- 1 cricchetto reversibile 1/4" Ⓢ
- 1 tronchesi a taglianti diagonali 160 mm
- 1 pinza universale 180 mm
- 1 pinze regolabili cerniera chiusa 250 mm
- 7 giravite lama piatta 2,5x50 - 3x75 - 3,5x100 - 4x125 - 5,5x100 - 5,5x150 - 6,5x150 mm
- 6 giravite Phillips PH0x60 - PH1x80 - PH1x120 - PH2x100 - PH2x150 - PH3x150 mm
- 7 chiavi maschio con impugnatura per viti con impronta Torx® T6-T7-T8-T9-T10-T15-T20
- 2 scalpelli piatti nervati 100-200 mm
- 1 martello tipo tedesco 300 g
- 1 mazzuola con battenti in materiale plastico Ø 35 mm
- 7 chiavi maschio esagonale piegate con estremità sferica ○ 2,5-3-4-5-6-8-10 mm
- 1 chiavi maschio esagonale piegate ○ 12 mm
- 31 inserti colorati con portainseri magnetico in astuccio tascabile ● ○ ⊕ ⊕ ⊕ ⊕
- 1 bussola portainseri

Beta N.	TR
30	
31	
32	
867/C52	
42	T01
90	T40
920A	T83
920/21	T83
920/22	T83
920/25	T83
920/42	T83
920/55	T83
900	T91
900ME	T91
900/20	T91
900/21	T91
900/25	T91
900BG/30	T91
900/42	T91
900/55	T91
1082	T156
1150	T156
1048N	T156
1201E	T211
1202E	T213
1207E/TX	T216
35	T234
1370	T234
1390	T234
96BP	T259
96N	T259
860MIX/A31	T259
895/1	T259



T01

T83



T91

T156

T40

T211



T213

T216

T234

T259



5904VU/4T

€

1.610,00 059241100

Assortimento consigliato in abbinamento con RSC23T - RSC24 - RSC24A - RSC24AXL - RSC24AXLP/7 - RSC24L/7 - RSC24L-CAB - C37 - C39 - C39T - C39SM - C39MD - RSC55 - RSC50 - C59

5908VU/2T

assortimento di 161 utensili in termoformato rigido in ABS

► Universali

N. pezzi/Descrizione

- 16 chiavi combinate 6÷21 mm
- 5 chiavi combinate 22 - 24 - 27 - 30 - 32 mm
- 5 cacciaspina Ø 2 - 3 - 4 - 5 - 6 mm
- 1 bulino Ø 4 mm
- 12 chiavi a forchetta 6x7 - 8x9 - 10x11 - 12x13 - 14x15 - 16x17 - 18x19 - 20x22 - 21x23 - 24x26 - 27x29 - 30x32 mm
- 9 chiavi maschio esagonale piegate ○ 1,5 - 2 - 2,5 - 3 - 4 - 5 - 6 - 8 - 10 mm
- 7 chiavi poligonali curve 6x7-8x9-10x11-12x13-14x15-16x17-18x19 mm
- 6 chiavi maschio esagonale con impugnatura ○ 2-2,5-3-4-5-6 mm
- 6 chiavi maschio con impugnatura per viti con impronta Torx® ○ T10-T15-T20-T25-T27-T30
- 19 chiavi a bussola esagonali 1/2" ○ 10-11-12-13-14-15-16-17-18 - 19-20-21-22-23-24-26-27-30-32 mm
- 5 chiavi a bussola maschio esagonale 1/2" ○ 5-6-8-10-12 mm
- 1 prolunga angolare - 1/2" 125 mm
- 1 prolunga angolare - 1/2" 250 mm
- 1 snodo 1/2"
- 1 quadro maschio 1/2" con spina scorrevole 305 mm
- 1 cricchetto reversibile 1/2" Ⓢ
- 13 chiavi a bussola esagonali 1/4" ○ 4-4,5-5-5,5-6-7-8-9-10-11-12-13-14 mm
- 6 chiavi a bussola maschio esagonale 1/4" ○ 2,5-3-4-5-6-8 mm
- 1 prolunga - 1/4" 50 mm
- 1 prolunga - 1/4" 150 mm
- 1 snodo 1/4"
- 1 quadro con impugnatura 1/4"
- 1 quadro scorrevole 1/4" 115 mm
- 1 cricchetto reversibile 1/4" Ⓢ
- 1 tronchesi a grande effetto taglienti diagonali 160 mm
- 1 pinza universale 180 mm
- 1 pinza a becchi mezzotondi dritti 160 mm
- 1 pinze becchi dritti per anelli elastici, per fori ○ 180 mm
- 1 pinze becchi piegati per anelli elastici, per fori ○ 170 mm
- 1 pinze becchi dritti per anelli elastici, per alberi ● 175 mm
- 1 pinze becchi piegati per anelli elastici, per alberi ● 175 mm
- 1 pinze regolabili cerniera chiusa 250 mm
- 1 pinza autobloccante 240 mm
- 7 giravite lama piatta ● 2,5x50-3x75-3,5x100-4x125-5,5x100-5,5x150-6,5x150 mm
- 3 giravite lama piatta ● 8x150-8x200-10x200 mm
- 2 giravite nano lama piatta ● 4x30-6,5x30 mm
- 6 giravite Phillips® Ⓢ PH0x60-PH0x100-PH1x80-PH1x120-PH2x100-PH2x150 mm
- 2 giravite Phillips® Ⓢ PH3x150-PH4x200 mm
- 2 giravite nano Phillips® Ⓢ PH1x30-PH2x30 mm
- 2 scalpelli piatti nervati 100-200 mm
- 1 martello tipo tedesco 300 g
- 1 mazzuola con battenti in materiale plastico Ø 35 mm
- 1 lima 200 mm
- 1 lima 200 mm
- 1 lima 200 mm
- 1 lima 200 mm
- 1 lima 200 mm
- 1 termoformato rigido in ABS

Beta N.	TR
42	T05
42	T06
31	T31
32	T31
55	T31
96N/SC9	T31
90	T40
96T	T52
97TTX	T55
920A	T82
920ME	T82
920AN/125	T82
920AN/250	T82
920/25	T82
920/42	T82
920/55	T82
900	T91
900ME	T91
900/20	T91
900/21	T91
900/25	T91
900BG/30	T91
900/42	T91
900/55	T91
1084	T138
1150	T138
1166	T138
1032	T145
1034	T145
1036	T145
1038	T145
1048N	T153
1052	T153
1290	T170
1290	T171
1290N	T171
1292	T172
1292	T173
1292N	T173
35	T234
1370	T234
1390	T234
1719BMA...Q	T236
1719BMA...T	T236
1719BMA...P	T236
1719BMA...M	T236
1719BMA...R	T236
VP4	



T05 T06 T31



T40 T52 T55 T91



T82 T138 T153



T145 T170 T171 T172



T173 T234 T236 VP4

5908VU/2T

€ 2.365,00 059081136

Assortimento consigliato in abbinamento con RSC23T - RSC24 da 6-7-8 cassette - RSC24A da 6-7-8 cassette - RSC24AXL - RSC24AXLP7 - RSC24L7 - RSC24L-CAB - RSC28 - C37 da 6-7-8 cassette - C39 da 6-7-8 cassette - C39MD - C39SM - RSC55 - RSC50 - C59

5914VU/M

Assortimento di 109 utensili per trolley C14, in vassoio morbido in EVA

► Universali

N. pezzi/Descrizione

- 31 inserti colorati con portainseri magnetico in astuccio tascabile ● ○ ⊕ ⊕ ⊕ ⊕
- 1 bussola portainseri
- 13 chiavi a bussola esagonali 1/4" ○ 4-4,5-5-5,5-6-7-8-9-10-11-12-13-14 mm
- 1 prolunga - 1/4" 150 mm
- 1 snodo 1/4"
- 1 quadro maschio 1/4"
- 1 quadro scorrevole 1/4"
- 1 cricchetto reversibile 1/4" ⊕
- 16 chiavi a bussola esagonali 1/2" ○ 10-11-12-13-14-15-16-17-18-19-21-22-24-27-30-32 mm
- 1 snodo 1/2"
- 1 prolunga angolare - 1/2"
- 1 quadro maschio 1/2" con spina scorrevole
- 1 cricchetto reversibile 1/2" ⊕
- 16 chiavi combinate 6-7-8-9-10-11-12-13-14-15-16-17-18-19-21-22 mm
- 9 chiavi maschio esagonale piegate ○
- 1 chiave regolabile a rullino 250 mm
- 1 forbici per elettricisti lame dritte
- 1 flessometro 5 mt
- 1 cutter con lama a settori
- 1 pinze regolabili cerniera chiusa 250 mm
- 1 tronchesi a taglienti diagonali 160 mm
- 1 pinza universale = 180 mm
- 1 pinza a becchi mezzotondi dritti ● 160 mm
- 3 giravite lama piatta ● 3,5x100-5,5x125-6,5x150 mm
- 3 giravite per viti con impronta a croce Phillips® ⊕ PH0x60-PH1x80-PH2x100 mm

Beta N.	TR
860MIX/A31	MCT1
895/1	MCT1
900	MCT1
900/...	MCT1
900/25	MCT1
900BG/30C	MCT1
900/42	MCT1
900/55	MCT1
920A	MCT1
920/25	MCT1
920AN/125	MCT1
920/42	MCT1
920/55	MCT1
42	MCT2
96/SC9	MCT2
111E	MCT2
1128BMX	MCT2
1692/5	MCT2
1771	MCT2
1048N	MCT3
1082BM	MCT3
1150BM	MCT3
1166BM	MCT3
1260	MCT3
1262	MCT3



MC T1



MC T2



MC T3

5914VU/M

€



1.143,00 059140112

Assortimento consigliato in abbinamento con C14

N.B.: per una corretta chiusura del modulo superiore del trolley, si consiglia di rimuovere il pannello portautensili sotto il coperchio.

5988U/7M

assortimento di 215 utensili in vassoio morbido in EVA



M01



M100



M213



M33

M86

M136

M234

► Universali

N. pezzi/Descrizione

- 22 chiavi combinate 6-7-8-9-10-11-12-13-14-15-16-17-18-19-20-21-22-24-27-30-32-36 mm
- 8 chiavi a forchetta 6x7-8x9-10x11-12x13-14x15-16x17-18x19-20x22 mm
- 9 chiavi maschio esagonale piegate \odot 1,5+10 mm
- 7 inserti maschio esagonale \odot 4-5-6-7-8-10-12 mm
- 7 inserti maschio esagonale \odot 4-5-6-7-8-10-12 mm
- 5 inserti a profilo XZN® \odot 5-6-8-10-12 mm
- 5 inserti a profilo XZN® \odot 5-6-8-10-12 mm
- 7 inserti per viti con impronta Torx® \odot T20-T25-T30-T40-T45-T50-T55
- 6 inserti per viti con impronta Torx® \odot T25-T30-T40-T45-T50-T55
- 7 inserti per viti con impronta Tamper Resistant Torx® \odot T20-T25-T30-T40-T45-T50-T55
- 1 bussole portainseri per 867
- 1 bussole portainseri per 867
- 1 bussola portainseri
- 1 bussola portainseri
- 1 bussola portainseri
- 13 chiavi a bussola esagonali 1/4" \odot 4-4,5-5-5,5-6-7-8-9-10-11-12-13-14 mm
- 9 chiavi a bussola a mano lunghe bocca esagonale \odot 5-6-7-8-9-10-11-12-13 mm
- 5 chiavi a bussola maschio esagonale 1/4" \odot 3-4-5-6-7 mm
- 4 chiavi a bussola a giravite per viti con intaglio 1/4" \bullet 0,8x4-1x5,5-1,2x6,5-1,2x8 mm
- 4 chiavi a bussola a giravite per viti con impronta a croce Phillips® 1/4" \oplus PH1-PH2-PH3-PH4
- 7 chiavi a bussola a giravite maschio per viti con impronta Torx® \odot T10-T15-T20-T25-T27-T30-T40
- 1 prolunga - 1/4" 50 mm
- 1 prolunga - 1/4" 100 mm
- 1 prolunga - 1/4" 150 mm
- 1 snodo 1/4"
- 1 quadro con impugnatura 1/4"
- 1 quadro scorrevole 1/4"
- 1 cricchetto reversibile 1/4" \oplus
- 21 chiavi a bussola esagonali 1/2" \odot 8-10-11-12-13-14-15-16-17-18-19-20-21-22-23-24-26-27-28-30-32 mm
- 1 raccordo con attacco quadro
- 1 snodo 1/2"
- 1 prolunga angolare - 1/2" 125 mm
- 1 prolunga angolare - 1/2" 250 mm
- 1 quadro maschio 1/2" con spina scorrevole
- 1 cricchetto reversibile 1/2" \oplus
- 8 chiavi a bussola 1/2" per viti con teste a profilo Torx® \odot 10-12-14-16-18-20-22-24 mm
- 11 chiavi a bussola a mano lunghe bocca esagonale \odot 10-12-13-14-15-16-17-18-19-21-22
- 1 tronchesi a grande effetto taglienti diagonali ∇ 160 mm
- 1 pinza universale \equiv 180 mm
- 1 pinza a becchi mezzotondi dritti \bullet 160 mm
- 6 giravite lama piatta \bullet 2,5x50-3x75-4x100-5,5x125-6,5x150-8x200 mm
- 1 giravite per viti a testa con intaglio \bullet 4x30 mm
- 4 giravite Phillips® \oplus PH0x60-PH1x80-PH2x100-PH3x150 mm
- 1 giravite Phillips® \oplus PH1X30 mm
- 12 chiavi maschio con impugnatura per viti con impronta Torx® \odot T6-T7-T8-T9-T10-T15-T20-T25-T27-T30-T40-T45
- 1 giravite cercafase \bullet
- 2 scalpelli piatti nervati 100-200 mm
- 1 martello tipo tedesco 300 g
- 1 mazzuola con battenti in materiale plastico \varnothing 35 mm

Beta N.	TR
42	M01
55	M33
96/SC9	M86
867PE	M86
867PE/L	M86
867XZN	M86
867XZNL	M86
867TX	M86
867TXL	M86
867RTX	M86
867/1	M86
867/2	M86
895/1	M100
895/3	M100
895/6	M100
900	M100
900L	M100
900ME	M100
900LP	M100
900PH	M100
900TX	M100
900/20	M100
900/20L	M100
900/21	M100
900/25	M100
900BG/30	M100
900/42	M100
900/55	M100
920A	M100
920/15	M100
920/25	M100
920AN/125	M100
920AN/250	M100
920/42	M100
920/55	M100
920FTX	M100
920AL	M100
1084BM	M136
1150BM	M136
1166BM	M136
1201E	M213
1201EN	M213
1202E	M213
1202EN	M213
1207E/TX	M213
1253	M213
35	M234
1370	M234
1390	M234

5988U/7M

2.380,00 059881019

Assortimento consigliato in abbinamento con RSC23T - RSC24 - RSC24A - RSC24AXL - RSC24AXLP/7 - RSC24L/7 - RSC24L-CAB - RSC28 - C37 - C39 - C39SM - C39MD - RSC55 - RSC50 - C59



5915VU/0 assortimento di 35 utensili

► Universali

N. pezzi/Descrizione

1	bulino 4 mm	Beta N.	32
1	scalpelli piatti nervati 125 mm		35
8	chiavi a forchetta 6x7-8x9-10x11-12x13-14x15-16x17-18x19-20x22 mm		55
7	chiavi maschio esagonale \odot 1,5-2-2,5-3-4-5-6 mm	96/BGS7	
1	chiave regolabile a rullino 150 mm		111E
1	pinze regolabili cerniera chiusa 250 mm		1048N
1	tronchesi a taglienti diagonali, finitura industriale ∇ 160 mm		1082G
1	forbici per elettricisti lame diritte	1128BMX	
1	pinze universali a grande effetto, finitura industriale \equiv 180 mm		1150G
1	pinze a becchi mezzotondi lunghissimi, diritti zigrinati manici ricoperti con 2 strati di PVC antiscivolo, finitura industriale \bullet 160 mm		1166G
4	giravite lama piatta \bullet 3x75-4x100-5,5x100-6,5x150 mm		1201E
3	giravite Phillips® \oplus PH0x60-PH1x80-PH2x100 mm		1202E
1	martello tipo tedesco 300 g		1370
1	flessometro 3 m		1692/3
1	cutter con lama a settori 18 mm		1771
1	coltello soccorso auto	1778SOS	
1	torcia LED ad alta luminosità, fino a 500 Lumen	1833S	

5915VU/0

€



424,00 059151021

Assortimento consigliato in abbinamento con C4 - C5 - C5S - C6T - C9MT



5915VU/1 assortimento di 45 utensili

► Universali

N. pezzi/Descrizione

2	punzoni \varnothing 2-3 mm	Beta N.	30
1	bulino \varnothing 4 mm		32
2	scalpelli piatti 125-150 mm		34
1	ugnetti 150 mm		36
14	chiavi combinate 6+14 - 17 - 19 - 21 - 22 - 24 mm		42
9	chiavi maschio esagonale piegate \odot 1,5 - 2 - 2,5 - 3 - 4 - 5 - 6 - 8 - 10 mm	96/SC9	
1	chiave regolabile a rullino 250 mm		111E
1	pinze regolabili cerniera chiusa 250 mm		1048N
1	tronchesi a taglienti diagonali, finitura industriale ∇ 160 mm		1082G
1	forbici per elettricisti lame diritte	1128BMX	
1	pinze universali a grande effetto, finitura industriale \equiv 180 mm		1150G
1	pinze a becchi mezzotondi lunghissimi, diritti zigrinati manici ricoperti con 2 strati di PVC antiscivolo, finitura industriale \bullet 160 mm		1166G
4	giravite lama piatta \bullet 3x75 - 4x100 - 5,5x100 - 6,5x150 mm		1201E
3	giravite Phillips® \oplus PH0x60 - PH1x80 - PH2x100 mm		1202E
1	martello tipo tedesco 300 g		1370
1	flessometro 5 m		1692
1	cutter con lama a settori		1771

5915VU/1

€



516,00 059151024

Assortimento consigliato in abbinamento con C8 - C9 - C10 - C10S - C11 - CP15 - CP15L - C16 - CP17 - CP17L - C18



5915VU/2 assortimento di 49 utensili

► Universali

N. pezzi/Descrizione

- 8 chiavi a forchetta 6x7 - 8x9 - 10x11 - 12x13 - 14x15
16x17 - 18x19 - 20x22 mm
- 9 chiavi maschio esagonale piegate \odot 1,5 - 2 - 2,5 - 3 - 4 - 5 - 6 - 8 - 10 mm
- 13 chiavi a bussola esagonali 1/4" \odot 4 - 4,5 - 5 - 5,5 - 6 - 7 - 8 - 9 - 10 - 11 - 12 - 13 - 14 mm
- 1 prolunga - 1/4" 150 mm
- 1 snodo 1/4"
- 1 quadro con impugnatura 1/4"
- 1 quadro scorrevole 1/4"
- 1 cricchetto reversibile 1/4" \oplus
- 1 pinze regolabili cerniera chiusa 250 mm
- 1 forbici per elettricisti lame diritte
- 1 pinze universali a grande effetto, finitura industriale \equiv 180 mm
- 4 giravite lama piatta \bullet 3x75 - 4x100 - 5,5x150 - 6,5x150 mm
- 3 giravite Phillips \oplus PH0x60 - PH1x80 - PH2x100 mm
- 1 martello tipo tedesco 300 g
- 1 flessometro 3 m
- 1 10 lame a settori 18 mm per cutter 1771, 1771BM e 1771HD
- 1 cutter con lama a settori 18 mm

Beta N.
55/B8N
96/SC9
900
900/21
900/25
900BG/30
900/42
900/55
1048N
1128BMX
1150G
1201E
1202E
1370
1692
1771RL
1771

5915VU/2

€ 447,00 059151027

Assortimento consigliato in abbinamento con C7 - CP15 - C20 - C20L



5915VU/3 assortimento di 74 utensili

► Universali

N. pezzi/Descrizione

- 1 cacciaspina \varnothing 4 mm
- 1 bulino \varnothing 4 mm
- 1 scalpelli piatti 150 mm
- 14 chiavi combinate 6-7-8-10-11-12-13-14-15-16-17-19-22-24 mm
- 9 chiavi maschio esagonale piegate \odot 1,5-10 mm
- 3 chiavi maschio esagonale con impugnatura \odot 4 - 5 - 6 mm
- 1 chiave regolabile a rullino 250 mm
- 13 chiavi a bussola esagonali 1/2" \odot 8-17 - 19 - 22 - 24 mm
- 1 prolunga - 1/2" 125 mm
- 1 prolunga - 1/2" 255 mm
- 1 snodo 1/2"
- 1 quadro maschio 1/2" con spina scorrevole
- 1 cricchetto reversibile 1/2" \oplus
- 8 chiavi a tubo doppie serie leggera 6x7 - 8x9 - 10x11 - 12x13 - 14x15 - 16x17 - 18x19 - 20x22 mm
- 2 spine di manovra per chiavi a tubo 1 - 2
- 1 pinze regolabili cerniera chiusa 250 mm
- 1 pinza autobloccante 240 mm
- 1 tronchesi a grande effetto, a taglienti diagonali, finitura industriale \neq 160 mm
- 1 forbici per elettricisti lame diritte
- 1 pinze universali a grande effetto, finitura industriale \equiv 180 mm
- 1 pinze a becchi mezzotondi lunghissimi, diritti zigrinati manici ricoperti con 2 strati di PVC antiscivolo, finitura industriale \bullet 160 mm
- 4 giravite lama piatta \bullet 3x75 - 4x100 - 5,5x150 - 6,5x150 mm
- 3 giravite Phillips \oplus PH0x60 - PH1x80 - PH2x100 mm
- 1 martello tipo tedesco 400 g
- 1 flessometro 5 m
- 1 seghetto
- 1 oliatore in plastica a pressione 150 cc
- 1 cutter con lama a settori

Beta N.
31
32
34
42
96/SC9
96T
111E
920A
920/21
920/22
920/25
920/42
920/55
935
940
1048VN
1052
1084G
1128BMX
1150G
1166G
1201E
1202E
1370
1692
1726
1754
1771

5915VU/3

€ 944,00 059151028

Assortimento consigliato in abbinamento con C7 - C9 - C10 - C10S - C11 - CP15L - C16 - CP17 - CP17L - C19 - C19L - C20 - C20L



5915VU/4

assortimento di 80 utensili

► Universali

N. pezzi/Descrizione

- 1 cacciaspina Ø 4 mm
- 1 bulino Ø 4 mm
- 1 scalpelli piatti 150 mm
- 15 chiavi combinate 6-7-8-9-10-11-12-13-14-15-16-17-19-22-24 mm
- 9 chiavi maschio esagonale piegate \odot 1,5+10 mm
- 1 chiave regolabile a rullino 250 mm
- 13 chiavi a bussola esagonali 1/2" \odot 8+17 - 19 - 22 - 24 mm
- 1 prolunga - 1/2" 255 mm
- 1 snodo 1/2"
- 1 quadro maschio 1/2" con spina scorrevole
- 1 cricchetto reversibile 1/2" \otimes
- 17 chiavi a pipa doppie esagonali - poligonali 6+22 mm
- 1 pinze regolabili cerniera chiusa 250 mm
- 1 pinza autobloccante 240 mm
- 1 tronchesi a grande effetto, a taglienti diagonali, finitura industriale \nlessgtr 160 mm
- 1 forbici per elettricisti lame diritte
- 1 pinze universali a grande effetto, finitura industriale \equiv 180 mm
- 1 pinze a becchi mezzotondi lunghissimi, diritti zigrinati, impugnatura bimatereale, finitura industriale \bullet 160 mm
- 4 giravite lama piatta \bullet 3x75 - 4x100 - 5,5x150 - 6,5x150 mm
- 3 giravite Phillips® \oplus PH0x60 - PH1x80 - PH2x100 mm
- 1 martello tipo francese 32 mm
- 1 flessometro 5 m
- 1 seghetto
- 1 oliatore in plastica a pressione 150 cc
- 1 cutter con lama a settori

Beta N.

- 31
- 32
- 34
- 42
- 96/SC9
- 111E
- 920A
- 920/22
- 920/25
- 920/42
- 920/55
- 932/S17
- 1048N
- 1052
- 1084GBM
- 1128BMX
- 1150GBM
- 1166GBM
- 1201E
- 1202E
- 1370F
- 1692
- 1726
- 1754
- 1771

5915VU/4 € 1.225,00 059151045

Assortimento consigliato in abbinamento con C20 - C20L



5915VU/5

assortimento di 111 utensili

► Universali

N. pezzi/Descrizione

- 1 cacciaspina Ø 4 mm
- 1 bulino Ø 4 mm
- 1 scalpelli piatti 150 mm
- 17 chiavi combinate 6-7-8-9-10-11-12-13-14-15-16-17-18-19-20-21-22 mm
- 8 chiavi a forchetta 6x7-8x9-10x11-12x13-14x15-16x17-18x19-20x22 mm
- 9 chiavi maschio esagonale piegate con estremità sferica \odot
- 1 chiave regolabile a rullino 250 mm
- 39 Serie di bussole \boxplus e accessori, in cassetta
- 13 Serie di bussole \boxminus e accessori, in cassetta
- 1 pinze regolabili cerniera chiusa 250 mm
- 1 pinza autobloccante 240 mm
- 1 tronchesi a taglienti diagonali, finitura industriale \nlessgtr 160 mm
- 1 tenaglie per cementisti 220 mm
- 1 forbici per elettricisti lame diritte
- 1 pinze universali a grande effetto, finitura industriale \equiv 180 mm
- 1 pinze a becchi mezzotondi lunghissimi, diritti zigrinati manici ricoperti con 2 strati di PVC antiscivolo, finitura industriale \bullet 160 mm
- 4 giravite lama piatta \bullet 3x75 - 4x100 - 5,5x100 - 6,5x150 mm
- 3 giravite Phillips® \oplus PH0x60 - PH1x80 - PH2x100 mm
- 1 martello tipo tedesco 300 g
- 1 mazzuola con battenti in materiale plastico Ø 35 mm
- 1 flessometro 3 m
- 1 lime a taglio mezzodolce
- 1 seghetto 440 mm
- 1 cutter con lama a settori 18 mm
- 1 torcia LED per ispezioni

Beta N.

- 31
- 32
- 34
- 42
- 55/S8
- 96BPC/SC9
- 111E
- 900/C11
- 920A/C11
- 1048N
- 1052
- 1082G
- 1098
- 1128BMX
- 1150G
- 1166G
- 1201E
- 1202E
- 1370
- 1390
- 1692/3
- 1719BMA8/M
- 1726
- 1771BM
- 1833XS/2

5915VU/5 € 1.200,00 059151046

Assortimento consigliato in abbinamento con C12 - C41H - C41S - C42H



5915VU/AS assortimento di 68 utensili

► Universali

N. pezzi/Descrizione

- 1 cacciaspina Ø 4 mm
- 1 bulino Ø 4 mm
- 1 scalpelli piatti 150 mm
- 13 chiavi combinate 1/4 - 5/16 - 3/8 - 7/16 - 1/2 - 9/16 - 5/8 - 11/16 - 3/4 - 13/16 - 7/8 - 15/16 - 1"
- 8 chiavi poligonali curve 1/4"+1"
- 9 chiavi maschio esagonale piegate brunate ○ 3/64"+3/8"
- 1 chiave regolabile a rullino 250 mm
- 11 chiavi a bussola poligonali □ 1/2" ○ 3/8 - 7/16 - 1/2 - 9/16 - 5/8 - 11/16 - 3/4 - 13/16 - 7/8 - 15/16 - 1"
- 1 prolunga - 1/2" 125 mm
- 1 prolunga - 1/2" 255 mm
- 1 snodo 1/2"
- 1 quadro maschio 1/2" con spina scorrevole
- 1 criccheto reversibile 1/2" ⊕
- 1 pinze regolabili cerniera chiusa 250 mm
- 1 pinza autobloccante 240 mm
- 1 tronchesi a grande effetto, a taglianti diagonali, finitura industriale 160 mm
- 1 forbici per elettricisti lame dritte
- 1 pinze universali a grande effetto, finitura industriale = 180 mm
- 1 pinze a becchi mezzotondi lunghissimi, diritti zigrinati, impugnatura bimatériale, finitura industriale ● 160 mm
- 4 giravite lama piatta ● 3x75 - 4x100 - 5,5x150 - 6,5x150 mm
- 3 giravite Phillips® ⊕ PH0x60 - PH1x80 - PH2x100 mm
- 1 martello tipo tedesco 300 g
- 1 flessometro 5 m
- 1 seghetto
- 1 oliatore in plastica a pressione 150 cc
- 1 cutter con lama a settori

Beta N.
31
32
34
42AS
90AS/8
96AS/SC9
111E
920AS
920/21
920/22
920/25
920/42
920/55
1048N
1052
1084GBM
1128BMX
1150GBM
1166GBM
1201E
1202E
1370
1692
1726
1754
1771

5915VU/AS

€ 1.039,00 059151032

Assortimento consigliato in abbinamento con C10 - C20 - C20L



MC10



MC20

5927VU/M assortimento di 108 utensili in vassoio morbido in EVA

► Universali

N. pezzi/Descrizione

- 16 chiavi combinate 6-7-8-9-10-11-12-13-14-15-16-17-18-19-21-22 mm
- 1 tronchesi a grande effetto taglianti diagonali 160 mm
- 9 chiavi maschio esagonale piegate ○ 1,5-2-2,5-3-4-5-6-8-10 mm
- 1 pinza universale = 180 mm
- 1 pinza a becchi mezzotondi diritti ● 160 mm
- 3 giravite lama piatta ● 3,5x100-5,5x150-6,5x150 mm
- 3 giravite Phillips® ⊕ PH0x3x60-PH1x4,5x80-PH2x6x100 mm
- 31 inserti colorati con portainseri magnetico in astuccio tascabile ● ⊕ ⊕ ⊕ ⊕
- 1 pinze regolabili cerniera chiusa 250 mm
- 1 martello tipo tedesco 300 mm
- 1 bulino 4 mm
- 1 ugnetti 4 mm
- 13 chiavi a bussola esagonali 1/4" ○ 4-4,5-5-5,5-6-7-8-9-10-11-12-13-14 mm
- 1 prolunga - 1/4" 150 mm
- 1 snodo 1/4"
- 1 quadro maschio 1/4"
- 1 quadro scorrevole 1/4"
- 1 criccheto reversibile 1/4" ⊕
- 16 chiavi a bussola esagonali 1/2" ○ 10-11-12-13-14-15-16-17-18-19-21-22-24-27-30-32 mm
- 1 snodo 1/2"
- 1 prolunga angolare - 1/2" 125 mm
- 1 quadro scorrevole 1/4"
- 1 criccheto reversibile 1/2" ⊕
- 1 bussola portainseri

Beta N.	TR
42	MC10
1084BM	MC10
96/SC9	MC10
1150BM	MC10
1166BM	MC10
1201E	MC10
1202E	MC10
860MIX/A31	MC20
1048N	MC20
1370	MC20
32	MC20
36	MC20
900	MC20
900/21	MC20
900/25	MC20
900BG/30C	MC20
900/42	MC20
900/55	MC20
920A	MC20
920/25	MC20
920AN/125	MC20
900/42	MC20
920/55	MC20
895/1	MC20

5927VU/M

€ 1.030,00 059271021

Assortimento consigliato in abbinamento con RSC22 - RSC23 - RSC23C - C27S

VP-LS



T211 T213 T216 VP3-SC
VP-LS



T145 T153 T137 VP3-SC
VP-LD VP-LD



T85



T234 T294

VP-LS



T80 T239 VP3-SC
VP-LS



T01 T33 VP3-SC
VP-LD VP-LD



T68 T236



T50

5938U/2T

assortimento di 210 utensili in termoformato rigido in ABS

► Universali

N. pezzi/Descrizione

- 7 giravite lama piatta ● 2,5x50 - 3x75 - 3,5x100 - 4x125
5,5x100 - 5,5x150 - 6,5x150 mm
- 6 giravite Phillips® ● PH0x60-PH1x80-PH1x120-PH2x100-PH2x150-PH3x150 mm
- 7 chiavi maschio con impugnatura per viti con impronta Torx® ● T6-T7-T8-T9-T10-T15-T20
- 1 pinze becchi diritti per anelli elastici, per fori ○ 180 mm
- 1 pinze becchi piegati per anelli elastici, per fori ○ 170 mm
- 1 pinze becchi diritti per anelli elastici, per alberi ● 175 mm
- 1 pinze becchi piegati per anelli elastici, per alberi ● 175 mm
- 1 pinze regolabili cerniera chiusa 250 mm
- 1 pinza autobloccante 240 mm
- 1 tronchesi a grande effetto taglienti diagonali ◄ 160 mm
- 1 pinza universale = 180 mm
- 1 pinza a becchi mezzotondi diritti ● 160 mm
- 1 chiave portainseri a cricchetto reversibile 1/4x5/16
- 13 chiavi a bussola esagonali 1/4" ○ 4-4,5-5-5,5-6-7-8-9-10-11-12-13-14 mm
- 1 cricchetto reversibile 1/4" ● 125 mm
- 1 quadro scorrevole 1/4" 115 mm
- 1 quadro con impugnatura 1/4" 176 mm
- 1 snodo 1/4" 41 mm
- 1 prolunga - 1/4" 150 mm
- 1 portainseri a sgancio rapido con impugnatura 230 mm
- 5 inserti per avvitatori per viti con impronta Spanner ● 4-6-8-10-12 mm
- 8 inserti per avvitatori per viti con impronta Torq-Set® ● 0-1-2-3-4-5-6-8 mm
- 6 inserti per avvitatori per viti con impronta Tri-Wing® ● 1-2-3-4-5-6 mm
- 8 inserti per avvitatori per viti con impronta Tamper Resistant Torx® ● T9-T10-T15-T20-T25-T27-T30-T40
- 11 inserti per avvitatori per viti con impronta Torx® ● T6-T7-T8-T9-T10-T15-T20-T25-T27-T30-T40
- 3 inserti per avvitatori per viti con impronta a croce Pozidriv® - Supadriv® ● PZ1 - PZ2 - PZ3
- 4 inserti per avvitatori per viti con impronta a croce Phillips® ● PH0 - PH1 - PH2 - PH3
- 8 inserti maschio esagonale per avvitatori ○ 2 - 2,5 - 3 - 4 - 5 - 6 - 8 - 10 mm
- 7 inserti per avvitatori per viti a testa con intaglio ● 0,5x3 - 0,6x4,5 - 0,8x5,5 - 1x5,5 - 1,2x6,5 - 1,2x8 - 1,6x8 mm
- 2 scalpelli piatti nervati 100 - 200 mm
- 1 martello tipo tedesco 300 g
- 1 mazzuola con battenti in materiale plastico Ø 35 mm
- 1 flessometro 5 m
- 1 miniseghetto
- 1 10 lame a settori 18 mm per cutter 1771, 1771BM e 1771HD
- 1 cutter con lama a settori
- 19 chiavi a bussola esagonali 1/2" ○ 10 - 11 - 12+19 - 20 - 21 - 22 - 23 - 24 - 26 - 27 - 30 - 32 mm
- 5 chiavi a bussola maschio esagonale 1/2" ○ 5 - 6 - 8 - 10 - 12 mm
- 1 prolunga - 1/2" 125 mm
- 1 prolunga - 1/2" 255 mm
- 1 snodo 1/2"
- 1 quadro maschio 1/2" con spina scorrevole
- 1 cricchetto reversibile 1/2" ●
- 1 bulino Ø 4 mm
- 6 cacciaspina con impugnatura 2-3-4-5-6-8 mm
- 17 chiavi combinate 6-7-8-10-11-12-13-14-16-17-18-19-21-22-24-27-30 mm
- 8 chiavi a forchetta 6x7 - 8x9 - 10x11 - 12x13 - 14x15 - 16x17 - 18x19 - 20x22 mm
- 9 chiavi maschio esagonale piegate ○
- 6 chiavi a T maschio esagonale 2,5 - 3 - 4 - 5 - 6 - 8 mm
- 5 lime a taglio mezzodolce 200 mm
- 11 chiavi maschio esagonale con impugnatura ○ 2 - 2,5 - 3 - 3,5 - 4 - 4,5 - 5 - 6 mm
- 4 termoformati vuoti
- 4 termoformati vuoti
- 4 termoformati vuoti

Beta N.	TR
1201E	T211
1202E	T213
1207E/TX	T216
1032	T145
1034	T145
1036	T145
1038	T145
1048N	T153
1052	T153
1084BM	T137
1150BM	T137
1166BM	T137
194	T85
900	T85
900/55	T85
900/42	T85
900BG/30	T85
900/25	T85
900/21	T85
851SR	T85
861SP	T85
861TQS	T85
861TRW	T85
861RTX	T85
861TX	T85
861PZ	T85
861PH	T85
861PE	T85
861LP	T85
35	T234
1370	T234
1390	T234
1692	T294
1725SCR	T294
1771	T294
920A	T80
920ME	T80
920/21	T80
920/22	T80
920/25	T80
920/42	T80
920/55	T80
32	T239
31BM	T239
42	T01
55	T33
96/SC9	T33
951	T68
1719BMA8/S5	T236
96T	T50
VP-3SC	VP-3SC
VP-LS	VP-LS
VP-LD	VP-LD



5938U/2T

2.530,00 059381062

Assortimento consigliato in abbinamento con C38



5957U-P

assortimento di 133 utensili - accessori di fissaggio inclusi

► Universali

N. pezzi/Descrizione	Beta N.
6 cacciapina 2 ÷ 8 mm	31/SP6
6 2 punzoni, 1 bulino, 3 scalpelli con supporto	38/SP6
17 serie di chiavi combinate 6÷22 - 24 - 27 - 30 mm	42/S17X
12 chiavi a forchetta 6x7 ÷ 30x32 mm	55/S12X
8 chiavi maschio esagonale con impugnatura 2 ÷ 10 mm	96T/S8
8 chiavi maschio piegate per viti con impronta Torx® T9 ÷ T40	97TX/SC8
1 chiave regolabile a rullino 250 mm	111E
13 chiavi a bussola esagonali 1/2" con guida Ø 10 ÷ 22 mm	920A/SB13
8 chiavi a bussola esagonali 1/2" con guida Ø 23 ÷ 32 mm	920A/SB8
7 chiavi a bussola a giravite per viti con impronta a croce Phillips®	920LH/SB7
1 pinza becchi dritti per anelli elastici, per fori Ø 180 mm	1032
1 pinza becchi piegati per anelli elastici, per fori Ø 170 mm	1034
1 pinza becchi dritti per anelli elastici, per alberi Ø 175 mm	1036
1 pinza becchi piegati per anelli elastici, per alberi Ø 175 mm	1038
1 pinza regolabili cerniera chiusa 250 mm	1048N
1 pinza autobloccante 240 mm	1052
1 cesoia a lame larghe diritte 250 mm	1112
1 forbici per elettricisti lame diritte	1128BMX
8 giravite 2,5x50 - 3x75 - 4x100 - 5,5x125 - 6,5x150 - PH0 - PH1 - PH2	1263/D8
2 martello tipo tedesco 300 - 600 g	1370
1 mazzuola con battenti in materiale plastico 35	1390
1 flessometro 5 m	1692/5
1 flessibile magnetico	1712E/2
1 raschietto a due taglienti 200 mm	1717A
1 raschietto a tre taglienti 200 mm	1717B
5 lime a taglio mezzodolce 200 mm	1719BMA8/S5
1 oliatore in metallo a pressione 200 cc	1751N
1 cutter con lama a settori	1771BM
1 prolunga - 1/2" 125 mm	920/21
1 prolunga - 1/2" 250 mm	920/22
1 snodo 1/2"	920/25
1 quadro maschio 1/2" con spina scorrevole	920/42
1 cricchetto reversibile 1/2"	920/55
1 leva con estremità a punta e piatta curva	963
1 tronchesi a taglienti diagonali 160 mm	1082BM
1 tronchesi a grande effetto taglienti diagonali 160 mm	1084BM
1 tronchesi doppia leva taglio frontale 180 mm	1092V
1 pinza universale 180 mm	1150BM
1 pinza a becchi mezzotondi dritti 160 mm	1166BM
1 pinza a becchi mezzotondi piegati 160 mm	1168BM
2 giravite lama piatta Ø 8x200 - 10x200 mm	1260
1 giravite per viti con impronta a croce Phillips® PH3 8x150mm	1262
1 calibro a corsoio	1650
1 seghetto 420 mm	1725



5957U-P

2.650,00 059571004

Assortimento consigliato in abbinamento con C57SA - C57SB - C57SP - C55PS - C55PSE - RSC55 - RSC50 I - RSC50 L



5958U

assortimento di 85 utensili - accessori di fissaggio inclusi

► Universali

N. pezzi/Descrizione	Beta N.
17 chiavi combinate 6÷22 mm	42
12 chiavi maschio esagonale piegate \odot 2÷10 mm	96N/SC12
13 chiavi a bussola esagonali 1/2" con guida \odot 10÷22 mm	920A/SB13
8 chiavi a bussola esagonali 1/2" con guida \odot 23÷32 mm	920A/SB8
1 prolunga - 1/2" 125 mm	920/21
1 prolunga - 1/2" 255 mm	920/22
1 snodo 1/2"	920/25
1 quadro maschio 1/2" con spina scorrevole	920/42
1 cricchetto reversibile 1/2" \otimes	920/55
1 pinze becchi dritti per anelli elastici, per fori \odot 180 mm	1032
1 pinze becchi dritti per anelli elastici, per alberi \bullet 175 mm	1036
1 pinze regolabili cerniera chiusa 250 mm	1048N
1 pinza autobloccante 240 mm	1052
1 tronchesi a grande effetto taglienti diagonali ∇ 160 mm	1084BM
1 forbici per elettricisti lame dritte	1128BMX
1 pinza universale \equiv 180 mm	1150BM
1 pinza a becchi mezzotondi dritti \bullet 160 mm	1166BM
7 giravite lama piatta \bullet 3x75 - 3,5x100 - 4x125	1260
5,5x150 - 6,5x150 - 8x200 - 10x200 mm	
4 giravite Phillips \oplus PH0x60 - PH1x80	1262/S4
PH2x100 - PH3x150 mm	
1 martello tipo tedesco 300 g	1370
1 mazzuola con battenti in materiale plastico \varnothing 35 mm	1390
1 flessometro 5 m	1692
5 serie di 5 lime 200 mm	1719BMA...S5
1 seghetto	1725
1 oliatore in plastica a pressione 150 cc	1754
1 cutter con lama a settori	1771

5958U

€ 1.340,00 059581008

Assortimento consigliato in abbinamento con C58P - C45PRO - RSC55 - RSC50 E - RSC50 F - RSC50 G - RSC50 H - RSC50 I - RSC50 L



5990V1

assortimento di 44 utensili per valigetta portautensili COMBO C99V1, in vassoio morbido in EVA

► Universali

N. pezzi/Descrizione

- 9 chiavi maschio esagonale piegate con estremità sferica ○
- 1 cutter con lama a settori 18 mm
- 1 pinze regolabili cerniera chiusa 250 mm
- 6 2 punzoni, 1 bulino, 2 scalpelli piatti e 1 ugnetto in busta avvolgibile in poliestere
- 3 giravite lama piatta ● 3,5x100-5,5x125-6,5x150 mm
- 3 giravite per viti con impronta a croce Phillips® ⊕ PH0x60-PH1x80-PH2x100 mm
- 1 forbici per elettricisti lame diritte
- 16 chiavi combinate 6-7-8-9-10-11-12-13-14-15-16-17-18-19-21-22 mm
- 1 flessometro 5 mt
- 1 martello tipo tedesco 300 g
- 1 tronchesi a taglienti diagonali, finitura industriale ✂ 160 mm
- 1 pinze universali a grande effetto, finitura industriale = 180 mm

Beta N.
96BPC/SC9
1771
1048N
38/B6N
1260
1262
1128BMX
42
1692/5
1370
1082GBM
1150GBM

5990V1

€ 623,00 059900001

Assortimento consigliato in abbinamento con C99V1



5990V3

assortimento di 116 utensili per valigetta portautensili COMBO C99V3/2C, in vassoio morbido in EVA

► Autoriparazione

N. pezzi/Descrizione

- 5 chiavi maschio esagonale con impugnatura
- 1 chiave regolabile a rullino 250 mm
- 1 quadro con impugnatura 1/4"
- 1 giravite cercafase ●
- 1 livella tascabile con base a "V"
- 1 torcia LED per ispezioni
- 31 inserti colorati con portainseri magnetico in astuccio tascabile ● ○ ⊕ ⊕ ⊕ ⊕
- 1 bussola portainseri
- 12 chiavi a bussola esagonali 1/4" ○ 4-4,5-5-5,5-6-7-8-9-10-11-12-13 mm
- 1 prolunga - 1/4" 50 mm
- 1 prolunga - 1/4" 100 mm
- 1 quadro scorrevole 1/4"
- 1 cricchetto reversibile con attacco quadro maschio 1/4" ⊕
- 38 microgiravite con 36 inserti intercambiabili da 4 mm e prolunga magnetica
- 1 mazzuola con battenti in materiale plastico Ø 35mm
- 1 snodo 1/4"
- 13 chiavi a bussola esagonali 1/2" ○ 10-11-12-13-14-15-16-17-18-19-20-21-22 mm
- 1 prolunga - 1/2" 125 mm
- 1 prolunga - 1/2" 255 mm
- 1 snodo 1/2"
- 1 quadro maschio 1/2" con spina scorrevole
- 1 cricchetto reversibile 1/2" ⊕

Beta N.
96T/S5P
111E
900BG/30
1253
1695XS
1833XS/2
860MIX/A31
895
900
900/20
900/20L
900/42
900/55Z
1256/C36-2
1390
900/25
920A
920/21
920/22
920/25
920/42
920/55

5990V3

€ 884,00 059900003

Assortimento consigliato in abbinamento con C99V3/2C



5980U/BIKE

assortimento di 90 utensili

► Riparazione biciclette

N. pezzi/Descrizione	Beta N.
5 chiavi combinate 8-9-10-13-14 mm	42
9 serie di chiavi maschio esagonale piegate con estremità sferica ○	96BP/SC9
1,5-2-2,5-3-4-5-6-8-10 mm	
8 chiavi maschio esagonale con impugnatura 2-2,5-3-4-5-6-8-10 mm	96T/S8
8 chiavi maschio con impugnatura per viti con impronta Torx® ⊕	97TTX/S8
T8-T10-T15-T20-T25-T27-T30-T40	
1 chiavi regolabili a rullino cromate corte	111CM
con apertura maggiorata 170 mm	
1 tagliatubi per rame e leghe leggere	334
1 chiavi dinamometriche a scatto con cricchetto reversibile 2+10 Nm	605E
13 chiavi a bussola a mano bocca esagonale ○ 4-4,5-5-5,5-6-7-8-9-10-11-12-13-14 mm	900/SB13
1 prolunga - 1/4"	900/21
1 snodo 1/4"	900/25
1 cricchetto reversibile 1/4" ⊕	900/55
1 tronchesi a taglianti diagonali, finitura industriale ⚡ 160 mm	1082G
1 forbici per elettricisti lame dritte 145 mm	1128BM
1 pinze universali a grande effetto, finitura industriale ≡ 180 mm	1150G
1 pinze a becchi mezzotondi lunghissimi, dritti zigrinati manici ricoperti con 2 strati di PVC antiscivolo, finitura industriale ● 180 mm	1166G
7 serie giravite 3x75-4x125-5,5x150-6,5x150-PH0x60-PH1x80-PH2x100 mm	1203E/D
1 martello tipo tedesco 300 g	1370
1 mazzuola con battenti in materiale plastico Ø 35 mm	1390
1 calibro a corsoio 150 mm	1650
1 flessometro 3 m	1692/3
1 lima 200 mm	1719BMA...P
1 lima 200 mm	1719BMA...M
1 lima 200 mm	1719BMA...R
1 seghetto 300 mm	1725
1 cutter con lama a settori	1771
1 indicatore usura catena 120 mm	3935
1 pinza per falsamaglia 170 mm	3937
7 chiavi coniche semplici 13-14-15-16-17-18-19 mm	3952/S7
1 chiave per pedali 15 mm	3953
1 tiraraggi nero 3,2mm □	3961 3,2
1 tiraraggi verde 3,3 mm □	3961 3,3
1 tiraraggi rosso 3,5 mm □ 3	3961 3,5
1 tiraraggi professionale □ 3,2 - 4,0 mm	3961U
1 chiave frusta smonta-pignoni 289 mm	3967
1 levagomme 200 mm	3969
3 kit di 3 levagomme, in plastica 113 mm	3969K3
1 leva per arretrare pastiglie freni a disco 222 mm	3991
1 chiave per raddrizzare dischi freno 234 mm	3992



5980U/BIKE 1.575,00 059801040

Assortimento consigliato in abbinamento con C16 - CP17 - CP17L - C20L

5980U/BIKE-M

assortimento di 106 utensili per la riparazione e manutenzione delle biciclette

► Riparazione biciclette

N. pezzi/Descrizione

- 16 chiavi combinate 6-7-8-9-10-11-12-13-14-15-16-17-18-19-20-21 mm
- 8 chiavi maschio esagonale con impugnatura \odot 2-2,5-3-4-5-6-7-8 mm
- 5 chiavi maschio con impugnatura per viti con impronta Torx® \odot TX10-TX15-TX20-TX25-TX30
- 1 tronchesi a grande effetto taglienti diagonali ∇ 160 mm
- 1 pinza universale \equiv 160 mm
- 1 pinza a becchi mezzotondi dritti \bullet 160 mm
- 6 giravite lama piatta \bullet 2,5x50-3x75-4x100-5,5x125-6,5x150-8x200 mm
- 1 giravite per viti a testa con intaglio \bullet 4x30 mm
- 4 giravite Phillips® \oplus PH0x60-PH1x80-PH2x100-PH3x150 mm
- 1 giravite Phillips® \oplus 4,5x30 mm
- 12 chiavi maschio con impugnatura per viti con impronta Torx® \odot TX6-TX7-TX8-TX9-TX10-TX15-TX20-T25-TX27-TX30-TX40-TX45
- 1 giravite cercafase \bullet
- 1 martello tipo tedesco 300 g
- 1 mazzuola con battenti in materiale plastico 35 mm
- 2 scalpelli piatti nervati 100-200 mm
- 1 serie di 5 lime 200 mm
- 1 flessometro 5 m
- 1 miniseghetto 250 mm
- 1 cutter con lama a settori
- 1 10 lame a settori 18 mm per cutter 1771, 1771BM e 1771HD
- 1 smagliacatena professionale compatibile con catene da 5 a 11 velocità
- 1 indicatore usura catena
- 1 pinza per falsamaglia
- 7 chiave conica semplice 13-14-15-16-17-18-19 mm
- 1 tiraraggi nero 3,2mm \square 3,2 mm
- 1 tiraraggi verde 3,3 mm \square 3,3 mm
- 1 tiraraggi rosso 3,5 mm \square 3,5 mm
- 1 tiraraggi professionale \square 3,2-4,0 mm
- 1 levagomme
- 1 kit di 3 levagomme, in plastica
- 1 chiave a bussola estrattore per movimento centrale a 16 tacche 39 mm
- 1 chiave a bussola estrattore per movimento centrale a 16 tacche 41 mm
- 1 chiave a bussola estrattore per movimento centrale a 16 tacche 46 mm
- 1 chiave a bussola estrattore per movimento centrale a 20 tacche con perno centrale nichelata 31,5 mm
- 1 chiave estrattore per ruote libere BMX a 4 innesti 35 mm
- 1 chiave estrattore per ruote libera Shimano® 22,8 mm
- 1 chiave estrattore per ruote libere Shimano® a cassetta con perno di guida 23,5 mm
- 1 chiave estrattore per ruote libere Campagnolo con perno di guida 23 mm
- 1 leva per arretrare pastiglie freni a disco
- 1 chiave per raddrizzare dischi freno
- 1 attrezzo per l'allineamento del forcellino-cambio
- 1 estrattore per pedivelle
- 1 chiave per pedali
- 2 chiavi a forchetta per serie sterzo universali 30x32-32x36 mm
- 1 chiave frusta smonta-pignoni
- 1 chiave per viti in metallo Shimano®

Beta N.	TR
42	M05
96T	M50
97TTX	M55
1084	M137
1150	M137
1166	M137
1201E	M213
1201EN	M213
1202E	M213
1202EN	M213
1207E/TX	M213
1253	M213
1370	M234
1390	M234
35	M234
1719BMA...S5	M236
1692	M294
1725CR	M294
1771	M294
1771RL	M294
3932U	M400
3935	M400
3937	M400
3952	M400
3961 3,2	M400
3961 3,3	M400
3961 3,5	M400
3961U	M400
3969	M400
3969K3	M400
3973/1	M400
3973/2	M400
3973/3	M400
3973/4	M400
3984/1	M400
3984/2	M400
3984/3	M400
3984/4	M400
3991	M400
3992	M400
3921	M401
3948	M401
3953	M401
3955	M401
3967	M401
3971	M401



M05 M50 M55



M137 M234 M236 M294



M213



M400



M401

5980U/BIKE-M € 2.075,00 059801050

Assortimento consigliato in abbinamento con RSC23T - RSC24 da 6-7-8 cassette - RSC24A da 6-7-8 cassette - RSC24AXL - RSC24AXLP/7 - RSC24L/7 - RSC24L-CAB RSC28 - C37 da 6-7-8 cassette - C39 da 6-7-8 cassette - C39MD - C39SM - RSC55 - RSC50 - C59

5988H/7M

assortimento di 333 utensili in vassoio morbido in EVA

► Autoriparazione

N. pezzi/Descrizione

- 13 chiavi a bussola a mano lunghe bocca esagonale ○ 8-9-10-11-12-13-14-15-16-17-19-21-22 mm
- 16 chiavi a bussola a mano lunghe bocca esagonale ○ 10-12-13-14-15-16-17-18-19-21-22-23-24-27-30-32 mm
- 7 chiavi a bussola 1/2" per viti con teste a profilo Torx® ⊕ E12-E14-E16-E18-E20-E22-E24
- 10 chiavi a bussola maschio esagonale 1/2" ○ 5-6-6L-7-8-8L-10-10L-12-12L mm
- 13 chiavi a bussola maschio per viti con impronta Torx® 1/2" ⊕ T20-T25-T27-T30-T30L-T40-T40L-T45-T50-T50L-T55-T60-T60L
- 8 chiavi a bussola maschio a profilo XZN® ○ 5-6-6-6L-8-8L-10-10L-12L mm
- 18 chiavi combinate 6-7-8-9-10-11-12-13-14-15-16-17-18-19-21-22-24-27 mm
- 7 chiavi poligonali curve 6x7-8x9-10x11-12x13-14x15-16x17-18x19 mm
- 1 adattatore a sgancio rapido 1/4" per chiavi a cricchetto 10 mm
- 1 adattatore a sgancio rapido 3/8" per chiavi a cricchetto 13 mm
- 1 adattatore a sgancio rapido 1/2" per chiavi a cricchetto 19 mm
- 12 chiavi combinate a cricchetto reversibile 8-9-10-11-12-13-14-15-16-17-18-19 mm
- 9 chiavi maschio esagonale piegate con estremità sferica ○ 1,5-2-2,5-3-4-5-6-8-10 mm
- 1 bussola portainseri ○ 1/4-□1/4
- 1 bussola portainseri ○ 1/4-□3/8
- 1 bussola portainseri ○ 5/16-□1/2
- 13 chiavi a bussola esagonali 1/4" ○ 4-4,5-5-5,5-6-7-8-9-10-11-12-13-14 mm
- 9 chiavi a bussola a mano lunghe bocca esagonale ○ 5-6-7-8-9-10-11-12-13 mm
- 4 chiavi a bussola a giravite per viti con intaglio 1/4" ● 0,8x4-1x5,5-1,2x6,51,2x8 mm
- 5 chiavi a bussola maschio esagonale 1/4" ○ 3-4-5-6-7 mm
- 4 chiavi a bussola a giravite per viti con impronta a croce Phillips® 1/4" ⊕ PH1-PH2-PH3-PH4
- 7 chiavi a bussola a giravite maschio per viti con impronta Torx® ⊕ T10-T15-T20-T25-T27-T30-T40
- 1 raccordo con attacco quadro □ 1/4-■ 3/8
- 3 prolunga - 1/4" 50-100-150 mm
- 1 snodo 1/4"
- 1 quadro scorrevole 1/4"
- 1 cricchetto reversibile 1/4" ⊕
- 1 quadro con impugnatura 1/4"
- 17 chiavi a bussola esagonali 3/8" ○ 6-7-8-9-10-11-12-13-14-15-16-17-18-19-20-21-22 mm
- 1 raccordo con attacco quadro □ 3/8-■ 1/4
- 1 raccordo quadro maschio 1/2" e femmina 3/8" □ 3/8-■ 1/2
- 1 prolunga - 3/8" 125 mm
- 1 prolunga - 3/8" 250 mm
- 1 snodo 3/8"
- 1 quadro maschio 3/8" con spina scorrevole
- 1 cricchetto reversibile 3/8" ⊕
- 21 chiavi a bussola esagonali 1/2" ○ 8-10-11-12-13-4-15-16-17-18-19-20-21-22-23-24-26-27-28-30-32 mm
- 2 prolunga angolare - 1/2" 125-250 mm
- 1 raccordo con attacco quadro □ 1/2-■ 3/8
- 1 snodo 1/2"
- 1 quadro maschio 1/2" con spina scorrevole
- 1 cricchetto reversibile 1/2" ⊕
- 3 chiavi a bussola per candele 3/8" ○ 16-17,8-20,8 mm
- 31 inserti colorati con portainseri magnetico in astuccio tascabile ○ ● ⊕ ⊕ ⊕ ⊕
- 1 pinze regolabili cerniera chiusa 250 mm
- 1 tronchesi a taglianti diagonali 160 mm
- 1 pinza universale ■ 180 mm
- 1 pinza becchi piatti dritti ■ 160 mm
- 5 giravite lama piatta ● 3x75-4x100-5,5x100-6,5x150-8x150 mm
- 1 giravite nano lama piatta ● 6,5x30 mm
- 3 giravite Phillips® ⊕ PH1-PH2-PH3
- 1 giravite nano Phillips® ⊕ PH2
- 4 chiavi maschio con impugnatura per viti con impronta Torx® ⊕ T20-T25-T27-T30
- 6 cacciaspina 2-3-4-5-6-8 mm
- 1 bulino 4 mm
- 3 scalpelli piatti 125-150-75 mm
- 1 ugnetti 125 mm
- 2 martello tipo tedesco 500-1000 g
- 1 magnete telescopico con testa flessibile
- 1 mazzuola con battenti in materiale plastico Ø 35 mm
- 1 flessometro 5 m
- 1 pinze becchi dritti per anelli elastici, per fori ○ 180 mm
- 1 pinze becchi piegati per anelli elastici, per fori ○ 170 mm
- 1 pinze becchi dritti per anelli elastici, per alberi ● 175 mm
- 1 pinze becchi piegati per anelli elastici, per alberi ● 175 mm
- 1 pinza a becchi mezzotondi lunghi lisci ● 140 mm
- 1 tronchese a taglianti diagonali normali 125 mm
- 4 microgiravite per viti senza testa con intaglio ● 2,0-2,5-3,0-3,5 mm
- 2 microgiravite per viti con impronta a croce Phillips® ⊕ 0-00
- 9 chiavi maschio con impugnatura per viti con impronta Torx® ⊕ T10-T15-T20-T25-T27-T30-T40-T45-T50
- 1 pinza autobloccante becchi lunghi 175 mm
- 1 pinze in plastica per occlusione tubi
- 1 pinza in plastica per occlusione tubi e manicotti
- 1 pinza in plastica per occlusione tubi e manicotti
- 1 calibro a corsoio
- 1 spessimetro
- 1 raschietto per guarnizioni
- 7 chiavi a bussola poligonale snodate doppie 6x7-8x9-10x11-12x13-14x15-16x17-18x19 mm
- 1 quadro maschio 1/2" snodato con impugnatura
- 1 leva piatta curva con impugnatura 450 mm
- 1 specchio telescopico 670 mm
- 1 lime a taglio mezzodolce 200 mm
- 1 lime a taglio mezzodolce 200 mm
- 1 lime a taglio mezzodolce 200 mm
- 1 lime a taglio mezzodolce 200 mm
- 1 lime a taglio mezzodolce 200 mm
- 1 spazzola fili d'acciaio

Beta N.	TR
910AL	M125
920AL	M125
920FTX	M125
920PE	M125
920TX	M125
920XZN	M125
	42 M25
	90 M25
	123Q1/4 M25
	123Q3/8 M25
	123Q1/2 M25
	142 M25
96BPC/SC9	M105
	895/1 M105
	895/3 M105
	895/6 M105
	900 M105
	900L M105
	900LP M105
	900ME M105
	900PH M105
	900TX M105
	900/16 M105
	900/...
	900/25 M105
	900/42 M105
	900/55 M105
900BG/30	M105
	910A M105
	910/15 M105
	910/16 M105
	910/21 M105
	910/22 M105
	910/25 M105
	910/25 M105
	910/42 M105
	920/25 M105
	920/42 M105
	920/55 M105
	956E M105
860MIX/A31	M166
	1048N M166
	1082BM M166
	1150BM M166
	1162BM M166
	1290 M166
	1290N M166
	1292 M166
	1292N M166
	1297TX M166
	31 M231
	32 M231
	34 M231
	36 M231
	1370 M231
	1712TF M231
	1390 M231
	1692 M125
	1032 M62
	1034 M62
	1036 M62
	1038 M62
	1177BM M62
	1188BM M62
	1257LP M62
	1257PH M62
	97TTX M62
	1052 M78
	1058 M78
	1481PL/A M78
	1481PL/B M78
	1481PL/C M78
	1650 M78
	1708/20 M78
	1716P M78
	80 M78
	920/36A M78
	965 M78
	1715 M231
	1719BMA8/M M231
	1719BMA8/P M231
	1719BMA8/Q M231
	1719BMA8/R M231
	1719BMA8/T M231
	1737NX M231



5988H/7M 5.410,00 059881087

Assortimento consigliato in abbinamento con RSC24 da 8 cassette - RSC24A da 8 cassette - RSC24AXL da 8 e 9 cassette - C37 da 8 cassette - C39 da 8 cassette - RSC28 - C59B - C55C8 - C55M8 - RSC55 - RSC50

5988L/4M

assortimento di 273 utensili in vassoio morbido in EVA

► Autoriparazione

N. pezzi/Descrizione



M105



M125



M25



M166

- 13 chiavi a bussola esagonali 1/4" ○ 4-4,5-5-5,5-6-7-8-9-10-11-12-13-14 mm
- 9 chiavi a bussola a mano lunghe bocca esagonale ○ 5-6-7-8-9-10-11-12-13 mm
- 9 chiavi maschio esagonale piegate con estremità sferica ○ 1,5-2,2,5-3-4-5-6-8-10 mm
- 1 bussola portainseri
- 1 bussola portainseri
- 1 bussola portainseri
- 5 chiavi a bussola maschio esagonale 1/4" ○ 3-4-5-6-7 mm
- 4 chiavi a bussola a giravite per viti con intaglio 1/4" ● 0,8x4-1x5,5-1,2x6,5-2x8 mm
- 4 chiavi a bussola a giravite per viti con impronta a croce Phillips® 1/4" ● PH1-PH2-PH3-PH4
- 7 chiavi a bussola a giravite maschio per viti con impronta Torx® ○ T10-T15-T20-T25-T27-T30-T40
- 1 raccordo con attacco quadro □ 1/4 - ■ 3/8
- 3 prolunga - 1/4" 50-100-150 mm
- 1 snodo 1/4"
- 1 quadro con impugnatura 1/4"
- 1 quadro scorrevole 1/4"
- 1 cricchetto reversibile 1/4" ⊕
- 17 chiavi a bussola esagonali 3/8" ○ 6-7-8-9-10-11-12-13-14-15-16-17-18-19-20-21-22 mm
- 1 raccordo con attacco quadro □ 3/8 - ■ 1/4
- 1 raccordo quadro maschio 1/2" e femmina 3/8" □ 3/8 - ■ 1/2
- 1 prolunga - 3/8" 125 mm
- 1 prolunga - 3/8" 250 mm
- 1 snodo 3/8"
- 1 quadro maschio 3/8" con spina scorrevole
- 1 cricchetto reversibile 3/8" ⊕
- 17 chiavi a bussola esagonali 1/2" ○ 8-10-11-12-13-14-15-16-17-18-19-20-21-22-23-24-26-27-28-30-32 mm
- 1 raccordo con attacco quadro □ 1/2 - ■ 3/8
- 1 snodo 3/8"
- 2 prolunga angolare - 1/2" 125 - 250 mm
- 1 quadro maschio 1/2" con spina scorrevole
- 1 cricchetto reversibile 1/2" ⊕
- 3 chiavi a bussola per candele 3/8" ○ 16-17,8-20,8 mm
- 13 chiavi a bussola a mano lunghe bocca esagonale ○ 8-9-10-11-12-13-14-15-16-17-19-21-22 mm
- 10 chiavi a bussola maschio esagonale 1/2" ○ 5-6-6L-7-8-8L-10-10L-12-12L mm
- 7 chiavi a bussola 1/2" per viti con teste a profilo Torx® ○ E12-E14-E16-E18-E20-E22-E24
- 13 chiavi a bussola maschio per viti con impronta Torx® 1/2" ○ T20-T25-T27-T30-T30L-T40-T40L-T45-T50-T50L-T55-T60-T60L
- 8 chiavi a bussola maschio a profilo XZN® ○ 5-6-6L-8-8L-10-10L-12L mm
- 16 chiavi a bussola a mano lunghe bocca esagonale ○ 10-12-13-14-15-16-17-18-19-21-22-23-24-27-30-32 mm
- 1 flessometro 5 m
- 18 chiavi combinate 6-7-8-9-10-11-12-13-14-15-16-17-18-19-21-22-24-27 mm
- 7 chiavi poligonali curve 6x7-8x9-10x11-12x13-14x15-16x17-18x19 mm
- 1 adattatore a sgancio rapido 1/4" per chiavi a cricchetto 10 mm
- 1 adattatore a sgancio rapido 3/8" per chiavi a cricchetto 13 mm
- 1 adattatore a sgancio rapido 1/2" per chiavi a cricchetto 19 mm
- 12 chiavi combinate a cricchetto reversibile 8-9-10-11-12-13-14-15-16-17-18-19 mm
- 31 inserti colorati con portainseri magnetico in astuccio tascabile ● ○ ⊕ ⊕ ⊕ ⊕
- 1 pinze regolabili cerniera chiusa 250 mm
- 1 tronchesi a taglienti diagonali 160 mm
- 1 pinza universale = 180 mm
- 1 pinza becchi piatti dritti = 160 mm
- 5 giravite lama piatta ● 3x75-4x100-5,5x100-6,5x150-8x150 mm
- 1 giravite nano lama piatta ● 6,5x30 mm
- 3 giravite Phillips® ⊕ 4,5x80-6x100-8x150 mm
- 1 giravite nano Phillips® ⊕ 6x30 mm
- 4 chiavi maschio con impugnatura per viti con impronta Torx® ○ T20-T25-T27-T30

Beta N.	TR
900	M105
900L	M105
96BPC/SC9	M105
895/1	M105
895/3	M105
895/6	M105
900ME	M105
900LP	M105
900PH	M105
900TX	M105
900/16	M105
900/...	M105
900/25	M105
900BG/30	M105
900/42	M105
900/55	M105
910A	M105
910/15	M105
910/16	M105
910/21	M105
910/22	M105
910/25	M105
910/42	M105
910/55	M105
920A	M105
920/15	M105
910/25	M105
920AN	M105
920/42	M105
920/55	M105
956E	M105
910AL	M125
920PE	M125
920FTX	M125
920TX	M125
920XZN	M125
920AL	M125
1692/5	M125
42	M25
90	M25
123Q1/4	M25
123Q3/8	M25
123Q1/2	M25
142	M25
860MIX/A31	M166
1048N	M166
1082BM	M166
1150BM	M166
1162BM	M166
1290	M166
1290N	M166
1292	M166
1292N	M166
1297TX	M166

5988L/4M

3.820,00 059881088

Assortimento consigliato in abbinamento con RSC24 - RSC24A - RSC24AXL - RSC24AXLP/7 - RSC24L/7 - RSC24L-CAB - C37 - C39 - C39T - C39SM - C39MD - RSC55 - RSC50 - C59

5988U6/M

assortimento di 214 utensili in vassoio morbido in EVA

► Universali

N. pezzi/Descrizione

- 22 chiavi combinate 6-7-8-9-10-11-12-13-14-15-16-17-18-19-20-21-22-24-27-30-32-36 mm
 11 chiavi a forchetta 6x7-8x9-10x11-12x13-14x15-16x17-18x19-20x22-21x23-24x27-30x32 mm
 11 chiavi poligonali curve 6x7-8x9-10x11-12x13-14x15-16x17-18x19-20x22-21x23-24x27-30x32 mm
 9 chiavi maschio esagonale piegate con estremità sferica \odot 1,5-2-2,5-3-4-5-6-8-10 mm
 6 giravite lama piatta \bullet 2,5x50-3x75-4x100-5,5x125-6,5x150-8x200 mm
 1 giravite per viti a testa con intaglio \bullet 4x30 mm
 4 giravite Phillips \oplus PH0x60-PH1x80-PH2x100-PH3x150 mm
 1 giravite Phillips \oplus PH1x30 mm
 12 chiavi maschio con impugnatura per viti con impronta Torx[®] \odot T6-T7-T8-T9-T10-T15-T20-T25-T27-T30-T40-T45
 1 giravite cercafase \bullet
 3 punzoni \varnothing 2-3-4 mm
 6 cacciaspina \varnothing 2-3-4-5-6-8 mm
 1 bulino \varnothing 4 mm
 1 scalpelli piatti 150 mm
 2 scalpelli piatti nervati 200-250 mm
 1 ugnetti 125 mm
 1 martello tipo tedesco 500 g
 1 mazzuola con battenti in materiale plastico \varnothing 35 mm
 1 flessometro 3 m
 1 magnete telescopico con testa flessibile
 1 lima 200 mm
 1 lima 200 mm
 1 lima 200 mm
 1 lima 200 mm
 1 lima 200 mm
 1 spazzola fili d'acciaio
 1 cutter con lama a settori 18 mm
 1 pinze becchi dritti per anelli elastici, per fori \odot 180 mm
 1 pinze becchi piegati per anelli elastici, per fori \odot 170 mm
 1 pinze becchi dritti per anelli elastici, per alberi \bullet 175 mm
 1 pinze becchi piegati per anelli elastici, per alberi \bullet 175 mm
 1 pinze regolabili cerniera chiusa 250 mm
 1 pinza autobloccante 240 mm
 1 tronchese a taglienti diagonali \nless 160 mm
 1 tenaglie per cementisti 220 mm
 1 cesoia a lame larghe diritte 250 mm
 1 forbici per elettricisti lame dritte
 1 pinza universale \equiv 180 mm
 1 pinza a becchi mezzotondi dritti \bullet 160 mm
 1 pinza a becchi mezzotondi piegati \bullet 160 mm
 1 bussola portainseriti
 1 bussola portainseriti
 1 bussola portainseriti
 13 chiavi a bussola esagonali 1/4" \odot 4-4,5-5-5,5-6-7-8-9-10-11-12-13-14 mm
 9 chiavi a bussola a mano lunghe bocca esagonale \odot 5-6-7-8-9-10-11-12-13 mm
 5 chiavi a bussola maschio esagonale 1/4" \odot 3-4-5-6-7 mm
 4 chiavi a bussola a giravite per viti con intaglio 1/4" \bullet 0,8x4-1x5,5-1,2x6,5-1,2x8 mm
 4 chiavi a bussola a giravite per viti con impronta a croce Phillips[®] 1/4" \oplus PH1-PH2-PH3-PH4
 7 chiavi a bussola a giravite maschio per viti con impronta Torx[®] \odot T10-T15-T20-T25-T27-T30-T40
 1 prolunga - 1/4" 50 mm
 1 prolunga - 1/4" 100 mm
 1 prolunga - 1/4" 150 mm
 1 snodo 1/4"
 1 quadro con impugnatura 1/4"
 1 quadro scorrevole 1/4"
 1 cricchetto reversibile 1/4" \oplus
 21 chiavi a bussola esagonali 1/2" \odot 8-10-11-12-13-14-15-16-17-18-19-20-21-22-23-24-26-27-28-30-32 mm
 1 raccordo con attacco quadro 125 mm
 1 snodo 1/2" 250 mm
 1 prolunga angolare - 1/2"
 1 prolunga angolare - 1/2"
 1 quadro maschio 1/2" con spina scorrevole
 1 cricchetto reversibile 1/2" \oplus
 8 chiavi a bussola 1/2" per viti con teste a profilo Torx[®] \odot 10-12-14-16-18-20-22-24 mm
 11 chiavi a bussola a mano lunghe bocca esagonale \odot 10-12-13-14-15-16-17-18-19-21-22 mm

Beta N.	TR
42	M01
55	M30
90	M30
96BPC/SC9	M30
1201E	M213
1201EN	M213
1202E	M213
1202EN	M213
1207E/TX	M213
1253	M213
30	M230
31	M230
30	M230
32	M230
34	M230
35	M230
36	M230
1370	M230
1390	M230
1692	M230
1712TF	M230
1719BMA...Q	M230
1719BMA...T	M230
1719BMA...P	M230
1719BMA...M	M230
1719BMA...R	M230
1737NX	M230
1771	M230
1032	M129
1034	M129
1036	M129
1038	M129
1048N	M129
1052	M129
1082BM	M129
1098	M129
1112	M129
1128BM	M129
1150BM	M129
1166BM	M129
1168BM	M129
895/1	M100
895/3	M100
895/6	M100
900	M100
900L	M100
900ME	M100
900LP	M100
900PH	M100
900TX	M100
900/20	M100
900/20L	M100
900/21	M100
900/25	M100
900BG/30	M100
900/42	M100
900/55	M100
920A	M100
920/15	M100
920/25	M100
920AN/125	M100
920AN/250	M100
920/42	M100
920/55	M100
920FTX	M100
920AL	M100



M01



M30



M213



M230



M129



M100



5988U6/M

3.210,00 059881430

Assortimento consigliato in abbinamento con RSC24 da 8 cassette - RSC24A da 8 cassette - RSC24AXL da 8-9 cassette
 RSC28 - C37 da 8 cassette - C39 da 8 cassette - C39SM - C39MD - RSC55 - RSC50 - C59B

5935ET/1MB

assortimento di 96 utensili per cassettera C35, in vassoio morbido in EVA



MB65



MB64



MB63

► Elettrotecnica

N. pezzi/Descrizione

- 1 pinza autobloccante 240 mm
- 1 martello tipo tedesco 500 g
- 1 mazzuola con battenti in materiale plastico Ø 35 mm
- 1 lima 200 mm
- 1 lima 200 mm
- 1 lima 200 mm
- 1 lima 200 mm
- 1 lima 200 mm
- 1 scalpelli piatti nervati 200 mm
- 1 pinze becchi dritti per anelli elastici, per fori Ø 180 mm
- 1 pinze becchi piegati per anelli elastici, per fori Ø 170 mm
- 1 pinze becchi dritti per anelli elastici, per alberi ● 175 mm
- 1 pinze becchi piegati per anelli elastici, per alberi ● 175 mm
- 1 tronchesi a grande effetto taglienti diagonali ⚡ 160 mm
- 1 pinza universale = 180 mm
- 1 pinza a becchi mezzotondi dritti ● 160 mm
- 9 chiavi maschio esagonale piegate con estremità sferica ○
- 1 giravite prensile lama piatta ●
- 1 giravite prensile Phillips® ⊕
- 1 giravite cercafase ●
- 6 chiavi a bussola esagonale con impegnatura ○ 5,5-6-7-8-10-13 mm
- 4 giravite Phillips® 1000V ⊕ PH0x60-PH1x80-PH2x100-PH3x150 mm
- 6 giravite lama parallela 1000V ● 2,5x75-3x100-4x100-5,5x125-6x150-8x175 mm
- 31 inserti colorati con portainseriti magnetico in astuccio tascabile ● ○ ⊕ ⊕ ⊕ ⊕
- 1 portainseriti magnetico isolato ⊕
- 8 chiavi a forchetta 6x7-8x9-10x11-12x13-14x15
16x17-18x19-20x22 mm
- 1 pinze regolabili a cerniera chiusa 250 mm
- 1 tronchesi a taglienti diagonali 1000V ⚡ 140 mm
- 1 forbici per elettricisti lame diritte con svasatore
- 1 tagliacavi 230 mm
- 1 pinze spellafili ⚡ 160 mm
- 1 pinza universale 1000V = 180 mm
- 1 pinze a becchi mezzotondi lunghissimi 1000V ● 160 mm
- 1 pinze a becchi mezzotondi lunghissimi piegati ● 160 mm
- 1 chiave regolabile a rullino 1000V 250 mm
- 1 cutter 1000V
- 1 pinzetta a molla a punte curve arrotondate 1000V
- 1 pinza per capicorda preisolati

Beta N.	TR
1052	MB65
1370	MB65
1390	MB65
1719BMA...Q	MB65
1719BMA...P	MB65
1719BMA...T	MB65
1719BMA...M	MB65
1719BMA...R	MB65
35	MB65
1032	MB65
1034	MB65
1036	MB65
1038	MB65
1084BM	MB65
1150BM	MB65
1166BM	MB65
96BPC/SC9	MB63
1250	MB63
1251	MB63
1253	MB63
943MQ	MB63
1272MQ	MB63
1274MQ	MB63
860MIX/A31	MB63
850MQ	MB63
55	MB64
1048MQ	MB64
1082MQ	MB64
1128BSX	MB64
1132MQ	MB64
1142MQ	MB64
1150MQ	MB64
1166MQ	MB64
1168MQ	MB64
110MQ	MB64
1777MQ	MB64
993MQ	MB64
1602	MB64

5935ET/1MB

1.935,00 059351332

Assortimento consigliato in abbinamento con C35



5980ET/A

assortimento di 70 utensili

► Elettrotecnica

N. pezzi/Descrizione	Beta N.
1 bulino Ø 4 m	32
1 scalpelli piatti nervati 150 mm	35
8 chiavi a forchetta 6x7 - 8x9 - 10x11 - 12x13 - 14x15 - 16x17 - 18x19 - 20x22 mm	55/B8N
8 chiavi maschio esagonale, tipo lungo Ø 2+10 mm	96LC/SC8
1 chiave regolabile a rullino 200 mm	111E
1 portainseri magnetico isolato ®	850MQ
10 inserti con portainseri magnetico ⚡ ⚡ ⚡	860MIX/A10
1 pinze regolabili a cerniera chiusa 250 mm	1048MQ
1 tronchesi a taglienti diagonali 160 mm	1082BM
1 forbici per elettricisti lame diritte con svasatore	1128BSX
1 tagliacavo 170 mm	1132BM
1 pinza universale 180 mm	1150BM
1 pinza a becchi mezzotondi diritti 160 mm	1166BM
1 pinza a becchi mezzotondi piegati 160 mm	1168BM
1 giravite prensile lama piatta 4x125 mm	1250
1 giravite prensile Phillips® PH1x125 mm	1251
1 giravite cercafase	1253
5 giravite lama piatta 2,5x75 - 3,5x100 - 5,5x125 - 6,5x150 mm	1201E
1 giravite per viti a testa con intaglio 4x30 mm	1201EN
4 giravite Phillips® PH0x60 - PH1x120 - PH2x150 - PH3x150 mm	1202E
1 giravite Phillips® PH2x30 mm	1202EN
4 giravite Phillips® 1000V PH0x60 - PH1x80 - PH2x100 - PH3x150 mm	1272MQ
5 giravite lama parallela 1000V 5,5x125 - 3x100 - 4x100 - 6,5x150 - 8x175 mm	1274MQ
1 scalpello piatto con tagliente laterale	1343
1 martello tipo tedesco 300 g	1370
1 mazzuola con battenti in materiale plastico Ø 35 mm	1390
1 pinza per capicorda preisolati	1602
1 nastro isolante in PVC 25 m	a
1 flessometro 5 m	1692
1 lima 200 mm	1719BMA...M
1 lima 200 mm	1719BMA...R
1 seghetto	1725
1 coltello a serramanico	1777BM

5980ET/A € 978,00 059801083

Assortimento consigliato in abbinamento con C12 - 2032/TV - 2028/VV



5980ET/B

assortimento di 64 utensili e 200 collari

► Elettrotecnica

N. pezzi/Descrizione

3	cacciaspina Ø 2 - 3 - 4 mm	Beta N.	31
1	bulino Ø 4 mm		32
1	scalpelli piatti 150 mm		34
8	chiavi a forchetta 6x7 - 8x9 - 10x11 - 12x13 - 14x15 - 16x17 - 18x19 - 20x22 mm		55/B8N
9	chiavi maschio esagonale piegate con estremità sferica ○ 1,5 - 2 - 2,5 - 3 - 4 - 5 - 6 - 8 - 10 mm		96BPC/SC9
1	sbavatore a raschietto 150 mm		345SB
6	chiavi a bussola esagonale con impugnatura 1000V ○ 5,5 - 6 - 7 - 8 - 10 - 13 mm		943MQ/S6
1	pinze regolabili a cerniera chiusa 250 mm		1048MQ
1	tronchesi a taglienti diagonali 1000V ≡ 160 mm		1082MQ
1	forbici per elettricisti lame diritte con svasatore		1128BSX
1	tagliacavi 230 mm		1132MQ
1	pinze spellafili ↓ 160 mm		1142MQ
1	pinza universale 1000V ≡ 180 mm		1150MQ
1	pinze a becchi mezzotondi lunghissimi 1000V ● 160 mm		1166MQ
1	giravite cercafase ●		1253
3	giravite Phillips® 1000V ⊕ PH0x60 - PH1x80 - PH2x100 mm		1272MQ
4	giravite lama parallela 1000V ● 3x100 - 4x100 - 5,5x125 - 6,5x150 mm		1274MQ
1	martello tipo tedesco 300 g		1370
1	mazzuola con battenti in materiale plastico Ø 35 mm		1390
1	pinza per capicorda preisolati		1602
1	riga flessibile graduata 250 mm		1682
1	punta per tracciare 250 mm		1688
1	flessometro 5 m		1692
1	livella in alluminio 200 mm		1696
1	scalpello per elettricisti 10x200 mm		1701NE3
1	traccialinea		1705
1	specchietto flessibile 600 mm		1715FL/A
1	lime a taglio mezzodolce 200 mm		1719BMA8/M
1	lime a taglio mezzodolce 200 mm		1719BMA8/R
1	tenditore per molle		1723
1	seghetto		1726BM
1	pennello		1738
1	pinza per collari in Nylon		1743
1	oliatore in plastica a pressione 150 cc		1754
100	fascette in nylon 3,6x200 mm		1748N
100	fascette in nylon 4,8x300 mm		1748N
1	cutter con lama a settori		1771BM
1	saldatore 30 W		1814M
1	torcia LED per ispezioni		1833XS/2

5980ET/B

1.345,00 059801084

Assortimento consigliato in abbinamento con C12 - 2029/VV - 2033L/VV - 2036/TV



5980MQ

assortimento di 46 utensili

► Elettrotecnica

N. pezzi/Descrizione

7	chiavi a forchetta 1000V 10 - 12 - 13 - 14 - 17 - 19 - 22 mm	Beta N.	52MQ
1	chiave regolabile a rullino 1000V 250 mm		110MQ
6	chiavi a bussola esagonale con impugnatura ○ 5,5 - 6 - 7 - 8 - 10 - 13 mm		943MQ
4	chiavi a T maschio esagonale ○ 4 - 5 - 6 - 8 mm		951MQ
1	pinzetta a molla a punte curve arrotondate 1000V		993MQ
1	pinze regolabili a cerniera chiusa 250 mm		1048MQ
1	tronchesi a taglienti diagonali 1000V ≡ 160 mm		1082MQ
1	forbici per elettricisti		1128MQ
1	pinze spellafili ↓ 160 mm		1142MQ
1	pinza universale 1000V ≡ 180 mm		1150MQ
1	pinze a becchi piatti lunghissimi piegati ≡ 160 mm		1164MQ
1	pinze a becchi mezzotondi lunghissimi 1000V ● 160 mm		1166MQ
1	giravite cercafase ●		1253
4	giravite Phillips® 1000V ⊕ PH0x60 - PH1x80 - PH2x100 - PH3x150 mm		1272MQ
5	giravite lama parallela 1000V ● 3x100 - 4x100 - 5,5x125 - 6,5x150 - 8x175 mm		1274MQ
1	martello tipo tedesco 300 g		1370
1	mazzuola con battenti in materiale plastico Ø 35 mm		1390
1	flessometro 5 m		1692
1	scalpelli per elettricisti 200 mm		1701NE/3
1	miniseghetto 1000V		1725MQ
2	cutter 1000V		1777MQ
1	saldatore 30 W		1814M
1	torcia LED ad alta luminosità, fino a 500 Lumen		1833S
1	tester combinato di tensione e continuità 12-690V AC/DC		1760PT

5980MQ

1.820,00 059801257

Assortimento consigliato in abbinamento con 2029/VV



M49



M108



M161

5988 VHB-MQ

assortimento di 66 utensili in vassoio morbido in EVA

► Elettrotecnica

N. pezzi/Descrizione

- 12 chiavi a forchetta 1000V 7-8-10-11-12-13-14-15-16-17-19-22 mm
- 12 chiavi poligonali semplici 7-8-10-11-12-13-14-15-16-17-19-22 mm
- 4 chiavi a bussola maschio esagonale \odot 4-5-6-8 mm
- 11 chiavi a bussola poligonali \odot 7-8-10-11-12-13-14-15-16-17-19 mm
- 6 chiavi a bussola maschio per viti con impronta Torx® \odot T15-T20-T25-T27-T30-T40
- 2 chiavi a bussola maschio a profilo XZN® \odot 8-10 mm
- 1 prolunga quadro maschio e femmina 3/8" 125 mm
- 1 prolunga quadro maschio e femmina 3/8" 250 mm
- 1 quadro maschio 3/8", a T
- 1 cricchetto reversibile con attacco quadro maschio 3/8"
- 1 forbici per elettricisti
- 1 pinze regolabili a cerniera chiusa 250 mm
- 1 tronchesi a taglienti diagonali 1000V \ddagger 160 mm
- 1 pinza universale 1000V \equiv 180 mm
- 1 pinze a becchi piatti lunghissimi dritti \equiv 160 mm
- 1 pinze a becchi piatti lunghissimi piegati \equiv 160 mm
- 4 giravite Phillips® 1000V \oplus PH0x60 - PH1x80 - PH2x100 - PH3x150 mm
- 4 giravite lama parallela 1000V \bullet 2,5x75 - 3x100 - 4x100 - 5,5x125 mm
- 1 coltello spellacavi isolato

Beta N.	TR
52MQ	M49
89MQ	M49
910MQ/PE	M108
910MQ/B	M108
910MQ/TX	M108
910MQ/XZN	M108
910MQ/21	M108
910MQ/22	M108
910MQ/T	M108
910MQ/55	M108
1128MQ	M161
1048MQ	M161
1082MQ	M161
1150MQ	M161
1162MQ	M161
1164MQ	M161
1272MQ	M161
1274MQ	M161
1777MQ/U	M161

5988 VHB-MQ € 3.000,00 059880300

Assortimento consigliato in abbinamento con RSC51- RSC23T - RSC24 - RSC24A - RSC24AXL - RSC24L7 - RSC24L-CAB RSC28 - C37 - C39 - C39SM - C39MD - C39T - RSC55 C59

5980EL/A

assortimento di 57 utensili

► Elettronica

N. pezzi/Descrizione

- 13 chiavi a forchetta doppie piccole 4÷14 mm
- 9 chiavi maschio esagonale piegate \odot 1,5÷10 mm
- 1 pinzetta punte fini curve 130 mm
- 1 pinzetta punte fini diritte 150 mm
- 1 pinzetta becchi dritti incrociati 155 mm
- 1 forbici per elettricisti lame diritte
- 1 pinza spellafili \ddagger 160 mm
- 1 pinza a becchi mezzotondi dritti \bullet 160 mm
- 1 pinza a becchi piatti lunghi \equiv
- 1 pinza a becchi mezzotondi lunghi piegati \bullet
- 1 pinza universale per elettronica \bullet
- 1 tronchese a taglienti diagonali rasi \ddagger
- 1 tronchese a taglienti diagonali normali \ddagger
- 1 giravite prensile lama piatta \bullet 4x125 mm
- 1 giravite prensile Phillips® \oplus PH0x125 mm
- 8 microgiraviti
- 1 martello tipo tedesco 200 g
- 1 flessometro 5 m
- 1 specchio telescopico
- 3 lime ad ago
- 1 tenditore per molle
- 1 pennello
- 1 oliatore a stilo
- 1 cutter con lama a settori
- 1 pinzetta autobloccante
- 1 saldatore 25 W
- 1 pompetta succhiastagno
- 1 torcia LED per ispezioni

Beta N.	TR
73/B13N	
96N/SC9	
991	
992	
998	
1128BMX	
1142BM	
1166BM	
1172BM	
1178BM/P	
1178BM	
1185BM	
1188BM	
1250	
1251	
1257LPH/S8	
1370	
1692	
1715	
1720/S3	
1723	
1738	
1756	
1771	
1002	
1814M	
1830T	
1833XS/2	

5980EL/A € 970,00 059801081

Assortimento consigliato in abbinamento con 2028/VV - 2032/TV - 2033L/VV

5980EL/B

assortimento di 98 utensili

► Elettronica

N. pezzi/Descrizione	Beta N.
13 chiavi a forchetta doppie piccole 4÷14 mm	73/B13N
9 chiavi maschio esagonale piegate \odot 1,5÷10 mm	96/SC9
8 chiavi maschio con impronta Torx® \odot T9 - T10 - T15 - T20 - T25 - T27 - T30 - T40	97TX/BG8
1 chiave regolabile a rullino 150 mm	111E
18 assortimento 13 bussole e 5 accessori 1/4"	900/C13-5
1 pinzetta a molla a punte fini diritte 130 mm	990
1 pinzetta punte fini curve 130 mm	991
1 pinzetta a molla a punte corte finissime 120 mm	999A
1 forbici per elettricisti lame diritte	1128BMX
1 Pinza spellafili frontale autoregolabile, con dispositivo di taglio 170 mm	1149F
1 pinza universale \equiv 180 mm	1150BM
1 pinza a becchi piatti lunghi \equiv 140 mm	1172BM
1 pinza a becchi mezzotondi lunghi lisci \bullet 140 mm	1177BM
1 pinza a becchi mezzotondi lunghi piegati \bullet 140 mm	1178BM/P
1 tronchese a taglienti diagonali rasi becchi arrotondati ζ 120 mm	1184BM
1 tronchese a taglienti diagonali rasi becchi assotigliati ζ 120 mm	1186BM
1 tronchese a taglienti frontali obliqui rasi ζ	1191BM
8 microgiraviti	1257LPH/S8
1 giravite cercafase \bullet	1253
1 giravite nano lama piatta \bullet 6,5x30 mm	1290N
3 giravite Phillips® \odot PH0x60 - PH1x80 - PH2x100 mm	1292
2 giravite nano Phillips® \odot PH1x30 - PH2x30 mm	1292N
5 giravite lama parallela \bullet 2,5x60 - 3x75 - 4x100 - 5x125 - 6,5x150 mm	1294
1 martello tipo tedesco 200 g	1370
1 riga flessibile graduata 150 mm	1682
1 punta per tracciare 220 mm	1688
1 flessometro 5 m	1692
1 specchietto telescopico 670 mm	1715
1 lime ad ago \bullet	1720R
1 lime ad ago \blacktriangle	1720T
1 lime ad ago \blacksquare	1720P
1 tenditore per molle	1723
1 pennello	1738
1 oliatore a stilo	1756
1 cutter con lama a settori	1771BM
1 coltello a serramanico	1777BM
1 pinzetta autobloccante	1002
1 saldatore 25W	1814M
1 pompetta succhiastagno	1830T
1 torcia LED per ispezioni	1833XS/2



5980EL/B

1.360,00 059801082

Assortimento consigliato in abbinamento con 2029/VV - 2033L/VV - 2036/TV



5980ID/1

assortimento di 24 utensili

► Idraulica

N. pezzi/Descrizione

Beta N.

1	chiave regolabile a rullino 250 mm	111E
1	mini-tagliatubi per rame e leghe leggere Ø 3+28 mm	332/2
1	tagliatubi per rame e leghe leggere Ø 3+30 mm	334
1	cesoia a cricchetto per tubi in materiale plastico Ø 0+42 mm	342
1	sbavatore a raschietto a lama fissa 140 mm	345SB2
2	giratubi svedese ganasce piane a 90° 320-410 mm	376
2	pinze regolabili cerniera chiusa 175-250 mm	1048N
1	forbici per elettricisti lame diritte	1128BMX
1	pinze universali a grande effetto, finitura industriale = 180 mm	1150GBM
4	giravite lama piatta 3x75-4x100-5,5x150-8x150 mm	1201E
2	giravite Phillips® PH1x80-PH2x100	1202E
1	martello tipo tedesco 500 g	1370
1	metro pieghevole in fibra 2 m	1690F
1	flessometro 5 m	1692/5
1	livella in alluminio 200 mm	1696
1	lima 200 mm	1719BMA...M
1	raspa piatta 200 mm	1719BM/RL
1	seghetto	1725



5980ID/1

575,00 059801086

Assortimento consigliato in abbinamento con 2009N/BV - C4 - C5 - C5S - C6T - C9MT

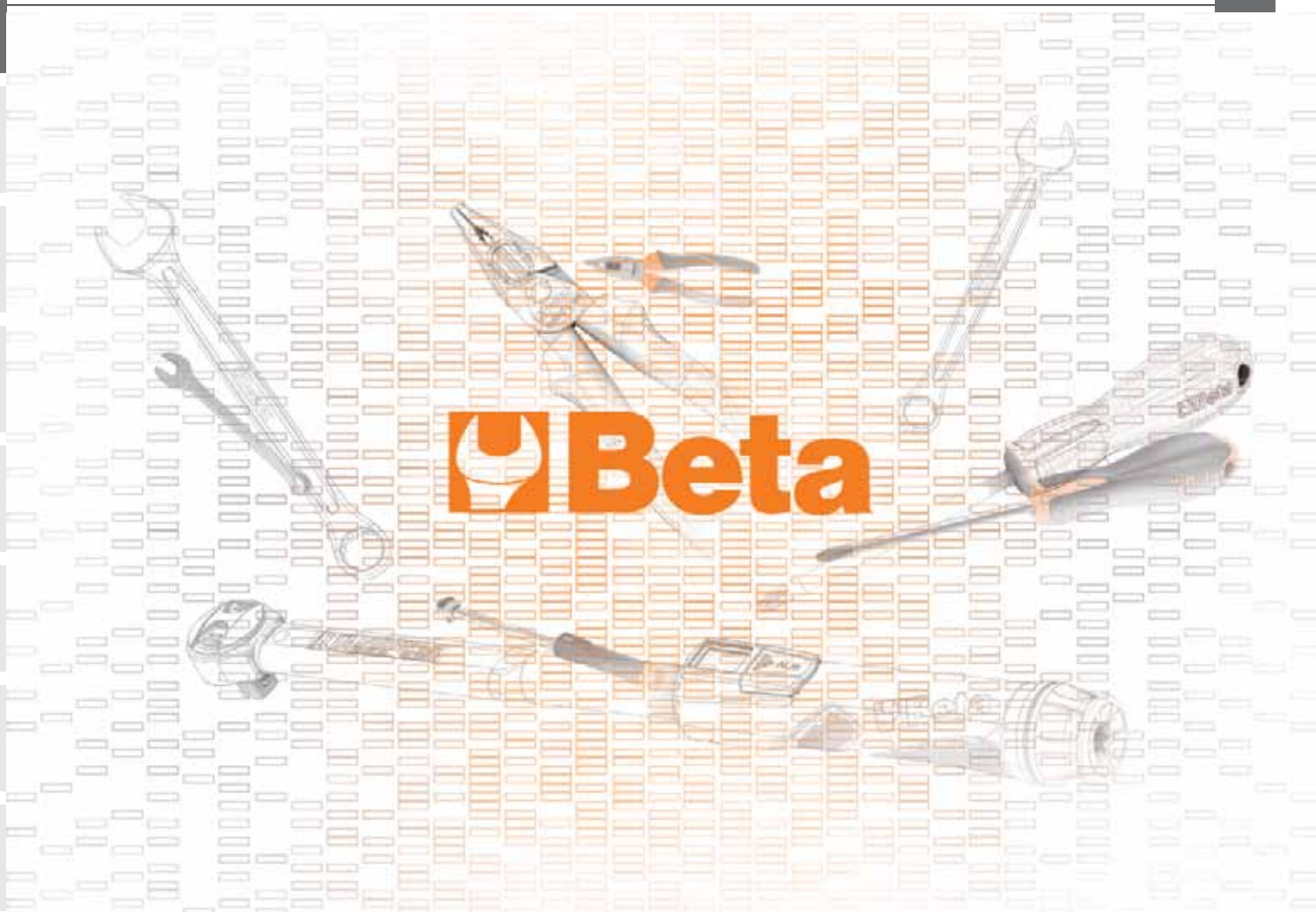

5989 VEM

assortimento di 81 utensili per la riparazione e manutenzione dei veicoli ibridi ed elettrici

► Autoriparazione

N. pezzi/Descrizione

- 1 tappeto isolante
- 4 colonnine in plastica con base riempibile
- 1 multimetro/megaohmetro per test isolamento ad alta tensione.
- 1 tester combinato di tensione e continuità 12-690V AC/DC
- 1 puntali di ricambio per multimetri digitali e pinze amperometriche
- 1 guanti isolanti compositi Gr. 10
- 1 strumento per la verifica pneumatica dei guanti isolati
- 1 catena plastica di delimitazione
- 2 cartelli di avvertenza in alluminio A1, A2
- 2 cartelli di divieto D2, D3
- 12 chiavi a forchetta 1000V 7-8-10-11-12-13-14-15-16-17-19-22 mm
- 12 chiavi poligonali semplici 7-8-10-11-12-13-14-15-16-17-19-22 mm
- 4 chiavi a bussola maschio esagonale \odot 4-5-6-8 mm
- 11 chiavi a bussola poligonali \odot 7-8-10-11-12-13-14-15-16-17-19 mm
- 6 chiavi a bussola maschio per viti con impronta Torx® \odot TX15-TX20-TX25-TX27-TX30-TX40
- 2 chiavi a bussola maschio a profilo XZN® \odot M8-M10
- 1 prolunga quadro maschio e femmina 3/8" 140 mm
- 1 prolunga quadro maschio e femmina 3/8" 265 mm
- 1 quadro maschio 3/8", a T 200 mm
- 1 cricchetto reversibile con attacco quadro maschio 3/8" 203 mm
- 1 pinze regolabili a cerniera chiusa 250 mm
- 1 tronchesi a taglianti diagonali 1000V \leq 160 mm
- 1 forbici per elettricisti 145 mm
- 1 pinza universale 1000V \equiv 180 mm
- 1 pinze a becchi piatti lunghissimi diritti \equiv 160 mm
- 1 pinze a becchi piatti lunghissimi piegati \equiv 160 mm
- 4 giravite Phillips® 1000V \oplus PH0-PH1-PH2-PH3
- 4 giravite lama parallela 1000V \bullet 2,5x75-3x100-4x100-5.5x125 mm
- 1 coltello spellacavi isolato 190 mm

Beta N.	TR
1995MQ/T	
7104 90	
1760/OHM	
1760PT	
1760DGT-R3	
1996MQ/GM	
1996VPG	
7105 6	
7109A	
7109D	
52MQ	M49
89MQ	M49
910MQ/PE	M108
910MQ/B	M108
910MQ/TX	M108
910MQ/XZN	M108
910MQ/21	M108
910MQ/22	M108
910MQ/T	M108
910MQ/55	M108
1048MQ	M161
1082MQ	M161
1128MQ	M161
1150MQ	M161
1162MQ	M161
1164MQ	M161
1272MQ	M161
1274MQ	M161
1777MQU	M161



M49



M108



M161



5989 VEM

€ 5.170,00 059890116

Assortimento consigliato in abbinamento con RSC23T - RSC24 - RSC24A - RSC24AXL - RSC24AXLP/7 - RSC24L/7 - RSC24L-CAB - RSC28 - C37 - C39 - C39T - C39SM - C39MD - RSC51 - RSC55 - RSC50 - C59

5902MT

assortimento di 106 utensili per macchine agricole, edili e movimento terra



► Movimento terra

N. pezzi/Descrizione

N. pezzi/Descrizione	Beta N.
2 punzoni Ø 3 - 4 mm	30
2 cacciaspina Ø 6 - 8 mm	31
1 bulino Ø 4 mm	32
2 scalpelli piatti nervati 150 - 200 mm	35
18 chiavi combinate 6÷14 - 17 - 19 - 22 - 24 - 27 - 30 - 32 - 36 - 41 mm	42
10 chiavi poligonali curve 6x7 - 8x9 - 10x11 - 12x13 - 14x15 - 16x17 - 18x19 - 20x22 - 24x27 - 30x32 mm	90
10 chiavi maschio esagonale piegate Ø 1,5÷12 mm	96N/B10
17 chiavi a bussola esagonali 1/2" ○ 10÷22 - 24 - 27 - 30 - 32 mm	920A
1 prolunga - 1/2" 125 mm	920/21
1 prolunga - 1/2" 255 mm	920/22
1 snodo 1/2"	920/25
1 quadro maschio 1/2" con spina scorrevole	920/42
1 cricchetto con quadro scorrevole 1/2" ⊗	920/50
11 chiavi a bussola esagonali 3/4" ○ 22 - 24 - 27 - 30 - 32 - 36 - 41 - 46 - 50 - 55 - 60 mm	928A
1 prolunga - 3/4" 200 mm	928/21
1 quadro maschio snodato 3/4" con impugnatura	928/36A
1 quadro maschio 3/4" con spina scorrevole	928/42
1 cricchetto reversibile 3/4" ⊗	928/55
1 leva con estremità a punta e a becco	964
1 pinze regolabili cerniera chiusa 250 mm	1048N
1 pinza autobloccante ganasce sagomate	1055
1 tronchese a grande effetto, a taglienti diagonali, finitura industriale 160 mm	1084GBM
1 forbici per elettricisti lame diritte	1128BMX
1 pinze universali a grande effetto, finitura industriale 180 mm	1150GBM
1 pinze a becchi mezzotondi lunghissimi, diritti zigrinati, impugnatura bimatereale, finitura industriale 160 mm	1166GBM
4 giravite lama piatta con esagono di manovra ● 6,5x150 - 8x175 - 10x200 - 12x250 mm	1260E
3 giravite Phillips® con esagono di manovra ● PH2x150 - PH3x175 - PH4x200 mm	1262E
1 martello testa tonda penna sferica 900 g	1377
1 mazzuola con battenti in materiale plastico Ø 35 mm	1390
1 spessimetro	1708/20
1 raschietto a tre taglienti 200 mm	1717B
5 serie di 5 lime 200 mm	1719BMA...S5
1 seghetto	1725



5902MT

2.260,00 059021053

Assortimento consigliato in abbinamento con RSC22 - RSC23 - RSC23C - C39T

5902MT/AS

assortimento di 99 utensili per macchine movimento terra (CATERPILLAR)

► Movimento terra

N. pezzi/Descrizione	Beta N.
2 punzoni Ø 3 - 4 mm	30
2 cacciaspina Ø 6 - 8 mm	31
1 bulino Ø 4 mm	32
2 scalpelli piatti nervati 150 - 200 mm	35
20 chiavi combinate 1/4+1.1/2"	42AS
6 chiavi poligonali curve 1/4x5/16 - 3/8x7/16 - 1/2x9/16 5/8x3/4 - 11/16x13/16 - 7/8x15/16"	90AS
11 chiavi maschio esagonale piegate ○ 3/64+3/8"	96AS/B11
10 chiavi a bussola poligonali □ 1/2" ○ 7/16 - 1/2 - 9/16 5/8 - 11/16 - 3/4 - 13/16 - 7/8 - 15/16 - 1"	920AS
1 prolunga - 1/2" 125 mm	920/21
1 prolunga - 1/2" 255 mm	920/22
1 snodo 1/2"	920/25
1 quadro maschio 1/2" con spina scorrevole	920/42
1 cricchetto con quadro scorrevole 1/2" ⊗	920/50
12 chiavi a bussola esagonali ○ □ 3/4", 7/8 - 15/16 - 1 - 1.1/16 - 1.1/8 - 1.1/4 - 1.5/16 1.1/2 - 1.5/8 - 1.11/16 - 1.7/8 - 2"	928AS
1 prolunga - 3/4" 200 mm	928/21
1 quadro maschio snodato 3/4" con impugnatura	928/36A
1 quadro maschio 3/4" con spina scorrevole	928/42
1 cricchetto reversibile 3/4" ⊗	928/55
1 leva con estremità a punta e a becco	964
1 pinze regolabili cerniera chiusa 250 mm	1048N
1 pinza autobloccante ganasce sagomate	1055
1 tronchesi a grande effetto, a taglienti diagonali, finitura industriale 160 mm	1084GBM
1 forbici per elettricisti lame diritte	1128BMX
1 pinze universali a grande effetto, finitura industriale 180 mm	1150GBM
1 pinze a becchi mezzotondi lunghissimi, diritti zigrinati, impugnatura bimateriale, finitura industriale 160 mm	1166GBM
4 giravite lama piatta con esagono di manovra ● 6,5x150 - 8x175 - 10x200 - 12x250 mm	1260E
3 giravite Phillips® con esagono di manovra ⊕ PH2x150 - PH3x175 - PH4x200 mm	1262E
1 martello testa tonda penna sferica 900 g	1377
1 mazzuola con battenti in materiale plastico Ø 35 mm	1390
1 spessimetro 150 - 200 mm	1708/20
1 raschietto a tre taglienti 200 mm	1717B
5 serie di 5 lime 200 mm	1719BMA...S5
1 seghetto	1725



5902MT/AS

2.350,00 059021054

Assortimento consigliato in abbinamento con RSC22 - RSC23 - RSC23C - C39T

5904VG/2M

assortimento di 170 utensili in vassoio morbido in EVA

► Autoriparazione

N. pezzi/Descrizione

- 16 chiavi combinate 6÷21 mm
- 5 chiavi combinate 22 - 24 - 27 - 30 - 32 mm
- 8 chiavi maschio esagonale con impugnatura \odot 2-2,5-3-4-5-6-7-8 mm
- 5 chiavi maschio con impugnatura per viti con impronta Torx® \odot T10-T15-T20-T25-T30
- 7 inserti maschio esagonale \odot 4-5-6-7-8-10-12 mm
- 7 inserti maschio esagonale \odot 4-5-6-7-8-10-12 mm
- 5 inserti a profilo XZN® \odot 5-6-8-10-12 mm
- 5 inserti a profilo XZN® \odot 5-6-8-10-12 mm
- 7 inserti per viti con impronta Torx® \odot T20-T25-T30-T40-T45-T50-T55
- 6 inserti per viti con impronta Torx® \odot T25-T30-T40-T45-T50-T55
- 7 inserti per viti con impronta Tamper Resistant Torx® \odot T20-T25-T30-T40-T45-T50-T55
- 1 bussole portainseri per 867
- 1 bussole portainseri per 867
- 5 giravite lama piatta \bullet 3x75 - 3,5x100 - 4x125 - 5,5x150 - 6,5x150 mm
- 3 giravite per viti con impronta a croce Phillips® \oplus PH0x60 - PH1x80 - PH2x100 mm
- 1 giravite nano lama piatta \bullet 4x30 mm
- 1 giravite nano Phillips® \oplus PH1x30 mm
- 5 inserti colorati per avvitatori per viti a testa con intaglio \bullet 0,5x3 - 0,6x4,5 - 0,8x5,5 - 1x5,5 - 1,2x6,5 mm
- 8 inserti colorati maschio esagonale per avvitatori \odot 2 - 2,5 - 3 - 4 - 5 - 6 - 8 - 10 mm
- 5 inserti colorati per avvitatori per viti con impronta a croce Phillips® \oplus PH0 - PH1 - PH2 - PH3 - PH4
- 4 inserti colorati per avvitatori per viti con impronta a croce Pozidriv® - Supadriv® \oplus PZ1 - PZ2 - PZ3 - PZ4
- 11 inserti colorati per avvitatori per viti con impronta Torx® \odot T6-T7-T8-T9-T10-T15-T20-T25-T27-T30-T40
- 8 inserti colorati per avvitatori per viti con impronta Tamper Resistant Torx® \odot T9-T10-T15-T20-T25-T27-T30-T40
- 1 portainseri a sgancio rapido con impugnatura 230 mm
- 1 cricchetto reversibile portainseri 100 mm
- 1 prolunga portainseri magnetica 80 mm
- 1 raccordi per avvitatori \blacksquare 1/4 - \square 1/4
- 2 scalpelli piatti nervati 100 - 200 mm
- 1 martello tipo tedesco 300 g
- 1 mazzuola con battenti in materiale plastico \varnothing 35 mm
- 1 prolunga angolare - 1/2" 125 mm
- 1 prolunga angolare - 1/2" 250 mm
- 1 snodo 1/2"
- 1 quadro maschio 1/2" con spina scorrevole
- 1 cricchetto reversibile 1/2" \oplus
- 19 chiavi a bussola esagonali 1/2" \odot 10+24 - 26 - 27 - 30 - 32 mm
- 1 pinza universale \equiv 180 mm
- 1 pinza a becchi mezzotondi diritti \bullet 160 mm
- 1 tronchesi a grande effetto taglienti diagonali ∇ 160 mm
- 1 pinze becchi diritti per anelli elastici, per fori \odot 180 mm
- 1 pinze becchi piegati per anelli elastici, per fori \odot 170 mm
- 1 pinze becchi diritti per anelli elastici, per alberi \bullet 175 mm
- 1 pinze becchi piegati per anelli elastici, per alberi \bullet 175 mm

Beta N.	TR
42	M05
42	M06
96T	M50
97TTX	M55
867PE	M86
867PE/L	M86
867XZN	M86
867XZN/L	M86
867TX	M86
867TX/L	M86
867RTX	M86
867T1	M86
867T2	M86
1260	M208
1262	M208
1260N	M208
1262N	M208
860LP	M85
860PE	M85
860PH	M85
860PZ	M85
860TX	M85
860RTX	M85
851SR	M85
860/55	M85
882P	M85
8920	M85
35	M234
1370	M234
1390	M234
920AN/125	M83
920AN/250	M83
920/25	M83
920/42	M83
920/55	M83
920A	M83
1150BM	M136
1166BM	M136
1084BM	M136
1032	M145
1034	M145
1036	M145
1038	M145



M05 M06 VPM3



M50 M55 M86



M208 M85 M234



M83 M136 M145



5904VG/2M

1.800,00 059041198

Assortimento consigliato in abbinamento con RSC23T - RSC24 - RSC24A - RSC24AXL - RSC24AXLP/7 - RSC24L/7 - RSC24L-CAB
RSC28 - C37 - C39 - C39T - C39SM - C39MD RSC55 - RSC50 - C59

5904VG/2T

assortimento di 99 utensili in termoformato rigido in ABS

► Autoriparazione

N. pezzi/Descrizione

- 16 chiavi combinate 6÷21 mm
- 5 chiavi combinate 22 - 24 - 27 - 30 - 32 mm
- 19 chiavi a bussola esagonali 1/2" \odot 10÷24 - 26 - 27 - 30 - 32 mm
- 5 chiavi a bussola maschio esagonale 1/2" \odot 5 - 6 - 8 - 10 - 12 mm
- 1 prolunga - 1/2" 125 mm
- 1 prolunga - 1/2" 255 mm
- 1 snodo 1/2"
- 1 quadro maschio 1/2" con spina scorrevole
- 1 cricchetto reversibile 1/2" \odot
- 1 pinze regolabili cerniera chiusa 250 mm
- 1 pinza autobloccante 240 mm
- 1 tronchesi a grande effetto taglienti diagonali ∇ 160 mm
- 1 pinza a becchi mezzotondi dritti \bullet 160 mm
- 1 pinza universale \equiv 180 mm
- 1 pinze becchi dritti per anelli elastici, per fori \odot 180 mm
- 1 pinze becchi dritti per anelli elastici, per alberi \bullet 175 mm
- 1 pinze becchi piegati per anelli elastici, per fori \odot 170 mm
- 1 pinze becchi piegati per anelli elastici, per alberi \bullet 175 mm
- 2 scalpelli piatti nervati 100 - 200 mm
- 1 martello tipo tedesco 300 g
- 1 mazzuola con battenti in materiale plastico \varnothing 35 mm
- 4 giravite lama piatta \bullet 3x75 - 4x100 - 5,5x150 - 6,5x150 mm
- 3 giravite per viti con impronta a croce Phillips® \oplus PH0x60 - PH1x80 - PH2x100 mm
- 8 chiavi a forchetta 6x7 - 8x9 - 10x11 - 12x13 - 14x15 - 16x17 - 18x19 - 20x22 mm
- 9 chiavi maschio esagonale piegate \odot 1,5 - 2 - 2,5 - 3 - 4 - 5 - 6 - 8 - 10 mm
- 6 chiavi maschio esagonale con impugnatura \odot 2 - 2,5 - 3 - 4 - 5 - 6 mm
- 6 chiavi maschio con impugnatura per viti con impronta Torx® \odot T10 - T15 - T20 - T25 - T27 - T30

Beta N.	TR
42	T05
42	T06
920A	T80
920ME	T80
920/21	T80
920/22	T80
920/25	T80
920/42	T80
920/55	T80
1048N	T153
1052	T153
1084	T138
1166	T138
1150	T138
1032	T145
1036	T145
1034	T145
1038	T145
35	T234
1370	T234
1390	T234
1260	T208
1262	T208
55	T33
96/SC9	T33
96T	T52
97TTX	T55



T05 T06 T80



T153 T138 T145 T234



T208 T33 T52 T55

5904VG/2T

1.535,00 059041191

Assortimento consigliato in abbinamento con: RSC51 - RSC23T - RSC24 - RSC24A - RSC24AXL - RSC24AXLP/7 - RSC24L/7 - RSC24L-CAB - RSC28 - C37 - C39 - C39SM - C39MD - C39T - RSC55 - RSC50 - C59

5904VG/3

assortimento di 132 utensili



► Autoriparazione

N. pezzi/Descrizione	Beta N.
6 cacciaspina Ø 2÷8 mm	31/B6N
1 bulino Ø 5 mm	32
1 scalpelli piatti nervati 200 mm	35
17 chiavi combinate 6÷22 mm	42
8 chiavi a forchetta 6x7 - 8x9 - 10x11 - 12x13 14x15 - 16x17 - 18x19 - 20x22 mm	55
9 chiavi maschio esagonale piegate Ø 1,5 - 2 - 2,5 - 3 - 4 - 5 - 6 - 8 - 10 mm	96N/SC9
11 chiavi maschio esagonale con impugnatura Ø 2÷10 mm	96T/SP11
13 chiavi maschio piegate per viti con impronta Torx® T6÷T50	97TX/B13
1 chiave regolabile a rullino 300 mm	111E
13 chiavi a bussola esagonali 1/2" con guida Ø 10÷22 mm	920A/SB13
1 prolunga - 1/2" 125 mm	920/21
1 prolunga - 1/2" 255 mm	920/22
1 snodo 1/2"	920/25
1 quadro maschio 1/2" con spina scorrevole	920/42
1 cricchetto con quadro scorrevole 1/2" ®	920/50
6 chiavi a T con bussola snodata Ø 8 - 10 - 12 - 13 - 17 - 19 mm	952
1 leva piatta curva con impugnatura 450 mm	965
2 pinze becchi dritti per anelli elastici, per fori Ø 180 - 225 mm	1032
2 pinze becchi piegati per anelli elastici, per fori Ø 170 - 210 mm	1034
2 pinze becchi dritti per anelli elastici, per alberi Ø 175 - 225 mm	1036
2 pinze becchi piegati per anelli elastici, per alberi Ø 175 - 220 mm	1038
1 pinze regolabili cerniera chiusa 250 mm	1048N
1 pinza autobloccante 240 mm	1057A
1 tronchesi a grande effetto, a taglienti diagonali, finitura industriale 200 mm	1084GBM
1 tronchesi doppia leva taglio frontale 200 mm	1092V
1 cesoia a lame larghe diritte 250 mm	1112
1 forbici per elettricisti lame diritte	1128BMX
1 pinze universali a grande effetto, finitura industriale = 180 mm	1150GBM
4 giravite lama piatta ● 3x75 - 4x100 - 5,5x125 - 6,5x150 mm	1260
1 giravite nano lama piatta ● 6,5x30 mm	1260N
2 giravite lama piatta con esagono di manovra ● 8x175 - 10x200 mm	1260E
3 giravite per viti con impronta a croce Phillips® PH0x100 - PH1x120 - PH2x100 mm	1262
1 giraviti nano Phillips® PH2x30 mm	1262N
1 giravite Phillips® con esagono di manovra PH3x175mm	1262E
1 giravite lungo Phillips® PH2x400 mm	1262L
1 giravite lungo lama parallela ● 6,5x400 mm	1264L
1 martello tipo tedesco 500 g	1370
1 mazzuola con battenti in materiale plastico Ø 45 mm	1390
1 chiave regolabile a nastro per filtri olio	1491
1 spessimetro	1708/20
5 serie di 5 lime 200 mm	1719BMA...S5
1 seghetto	1726BM
1 oliatore in metallo a pressione 200 cc	1751N

5904VG/3

€ 2.405,00 059041062

Assortimento consigliato in abbinamento con RSC24 - RSC24A - RSC24AXL - RSC24AXLP/7 - RSC24L/7 - RSC24L-CAB - C37
C39 da 7 - 8 cassetti - RSC55 - RSC50 - C59

5904VG/3T

assortimento di 102 utensili in termoformato rigido in ABS

► Autoriparazione

N. pezzi/Descrizione

- 21 chiavi combinate 6-7-8-9-10-11-12-13-14-15-16-17
18-19-20-21-22-24-27-30-32 mm
- 8 chiavi a forchetta 6x7-8x9-10x11-12x13-14x15
16x17-18x19-20x22 mm
- 9 chiavi maschio esagonale piegate \odot 1,5÷10 mm
- 6 chiavi maschio esagonale con impugnatura \odot 2-2,5-3-4-5-6 mm
- 8 chiavi a T con bussola snodata \odot 7-8-10-12-13-14-17-19 mm
- 19 chiavi a bussola esagonali 1/2" \odot 10-11-12-13-14-15-16-17-18-19
20-21-22-23-24-26-27-30-32 mm
- 1 prolunga - 1/2" 125 mm
- 1 prolunga - 1/2" 255 mm
- 1 snodo 1/2"
- 1 quadro maschio 1/2" con spina scorrevole 305 mm
- 1 cricchetto reversibile 1/2" \otimes
- 1 tronchesi a grande effetto taglienti diagonali ∇ 160 mm
- 1 pinza universale \equiv 180 mm
- 1 pinza a becchi mezzotondi dritti \bullet 160 mm
- 1 pinze becchi dritti per anelli elastici, per fori \odot 180 mm
- 1 pinze becchi piegati per anelli elastici, per fori \odot 170 mm
- 1 pinze becchi dritti per anelli elastici, per alberi \bullet 175 mm
- 1 pinze becchi piegati per anelli elastici, per alberi \bullet 175 mm
- 1 pinza autobloccante 240 mm
- 1 pinze regolabili cerniera chiusa 250 mm
- 7 giravite lama piatta \bullet 2,5x50 - 3x75 - 3,5x100 - 4x125 - 5,5x100 - 5,5x150 - 6,5x150 mm
- 6 giravite per viti con impronta a croce Phillips® \oplus PH0x60 - PH0x100 - PH1x80
PH1x120 - PH2x100 - PH2x150 mm
- 2 scalpelli piatti nervati 100-200 mm
- 1 martello tipo tedesco 300 g
- 1 mazzuola con battenti in materiale plastico \varnothing 35 mm
- 1 termoformato vuoto

Beta N.	TR
42T05-T06	
55	T33
96/SC9	T33
96T	T52
952	T63
920A	T83
920/21	T83
920/22	T83
920/25	T83
920/42	T83
920/55	T83
1084BM	T137
1150BM	T137
1166BM	T137
1032	T145
1034	T145
1036	T145
1038	T145
1052	T153
1048N	T153
1260	T199
1262	T202
35	T234
1370	T234
1390	T234
VP5	



T199 T202 T83



T145 T153 T137 T234



T52 T33 T05 T06



T63 VP5

5904VG/3T

1.775,00 059041510

Assortimento consigliato in abbinamento con RSC23T - RSC24 - RSC24A - RSC24AXL - RSC24AXLP/7 - RSC24L/7 - RSC24L-CAB
RSC28 - C37 - C39 - C39MD - C39SM - C39T - RSC55 - RSC50 - C59

5904VG/5T

assortimento di 153 utensili in termoformato rigido in ABS

► Autoriparazione

N. pezzi/Descrizione

- 5 chiavi a bussola maschio esagonale 1/2" \odot 5 - 6 - 8 - 10 - 12 mm
- 1 prolunga - 1/2" 125 mm
- 1 prolunga - 1/2" 255 mm
- 1 snodo 1/2"
- 1 quadro maschio 1/2" con spina scorrevole
- 1 cricchetto reversibile 1/2" \oplus
- 19 chiavi a bussola esagonali 1/2" \odot 10+24 - 26 - 27 - 30 - 32 mm
- 16 chiavi combinate 6+21 mm
- 5 chiavi combinate 22 - 24 - 27 - 30 - 32 mm
- 8 chiavi a T con bussola snodata \odot 7 - 8 - 10 - 12 - 13 - 14 - 17 - 19 mm
- 1 termoformato vuoto
- 1 pinze becchi diritti per anelli elastici, per fori \odot 180 mm
- 1 pinze becchi piegati per anelli elastici, per fori \odot 170 mm
- 1 pinze becchi diritti per anelli elastici, per alberi \bullet 175 mm
- 1 pinze becchi piegati per anelli elastici, per alberi \bullet 175 mm
- 7 giravite lama piatta \bullet 2,5x50 - 3x75 - 3,5x100 - 4x125 - 5,5x100 - 5,5x150 - 6,5x150 mm
- 5 chiavi maschio con impugnatura per viti con impronta Torx® \odot T25 - T27 - T30 - T40 - T45
- 6 chiavi maschio esagonale con impugnatura \odot 2 - 2,5 - 3 - 4 - 5 - 6 mm
- 8 chiavi a forchetta 6x7 - 8x9 - 10x11 - 12x13 - 14x15 - 16x17
18x19 - 20x22 mm
- 9 chiavi maschio esagonale piegate \odot 1,5 - 2 - 2,5 - 3 - 4 - 5 - 6 - 8 - 10 mm
- 3 giravite lama piatta \bullet 8x150 - 8x200 - 10x200 mm
- 2 giravite nano lama piatta \bullet 4x30 - 6,5x30 mm
- 6 giravite Phillips® \oplus PH0x60 - PH0x100 - PH1x80 - PH1x120 - PH2x100 - PH2x150 mm
- 2 giravite Phillips® \oplus PH3x150 - PH4x200 mm
- 2 giravite nano Phillips® \oplus PH1x30 - PH2x30 mm
- 2 scalpelli piatti nervati 100 - 200 mm
- 1 martello tipo tedesco 300 g
- 1 mazzuola con battenti in materiale plastico \varnothing 35 mm
- 1 pinza universale \equiv 180 mm
- 1 pinza a becchi mezzotondi diritti \bullet 160 mm
- 1 tronchese a grande effetto taglienti diagonali ∇ 160 mm
- 6 inserti per avvitatori per viti con impronta Torx® \odot T6+T15
- 8 inserti per avvitatori per viti con impronta Torx® \odot T20+T55
- 1 bussola portainseri
- 1 bussola portainseri
- 6 chiavi a bussola 1/4" per viti con teste a profilo Torx® \odot E4+E10
- 7 chiavi a bussola 1/2" per viti con teste a profilo Torx® \odot E12+E24
- 3 chiavi a bussola maschio per viti con impronta Torx® 1/2" \odot T55L - T60 - T70L
- 1 pinze regolabili cerniera chiusa 250 mm
- 1 pinza autobloccante 240 mm

Beta N.	TR
920ME	T80
920/21	T80
920/22	T80
920/25	T80
920/42	T80
920/55	T80
920A	T80
42	T05
42	T06
952	T63
VP6	VP6
1032	T145
1034	T145
1036	T145
1038	T145
1290	T170
1297TX	T176
96T	T52
55	T33
96N/SC9	T33
1290	T171
1290N	T171
1292	T172
1292	T173
1292N	T173
35	T234
1370	T234
1390	T234
1150BM	T137
1166BM	T137
1084BM	T137
861TX	T112
866TX	T112
895/1	T112
895/6	T112
900FTX	T112
920FTX	T112
920TX	T112
1048N	T153
1052	T153



T80 T05 T06



T63 VP6



T145 T170 T176 T52



T33 T171 T172 T173



T234 T137 T112 T153

5904VG/5T € 2.460,00 059041196

Assortimento consigliato in abbinamento con RSC23T - RSC24 da 7-8 cassette - RSC24A da 7-8 cassette - RSC24AXL da 7-8 cassette - RSC24AXLP/7 - RSC24L/7 - RSC24L-CAB - RSC28 - C37 da 7-8 cassette - C39 da 7-8 cassette - C39MD - C39SM - RSC35 - RSC50 - C59



5905VG/1

assortimento di 94 utensili per carrozzieri

► Autoriparazione

N. pezzi/Descrizione	Beta N.
1 punzoni Ø 4 mm	30
6 cacciapina Ø 2 - 3 - 4 - 5 - 6 - 8 mm	31/B6N
1 bulino Ø 4 mm	32
1 scalpelli piatti 150 mm	34
1 ugnetti 150 mm	36
17 chiavi combinate 6÷22 mm	42
10 chiavi maschio esagonale piegate \odot 1,5÷12 mm	96/B10
1 chiavi regolabili a rullino fosfatate con scala graduata 300 mm	111EN
12 chiavi a bussola con impugnatura, tipo lungo \odot 4÷14 mm	943BX
1 leva piatta curva con impugnatura 450 mm	965
1 pinze regolabili cerniera chiusa 250 mm	1048N
1 pinza autobloccante 240 mm	1052
1 pinza autobloccante ganasce alluminio 280 mm	1060AL
1 tronchesi a grande effetto, a taglianti diagonali, finitura industriale ∇ 160 mm	1084GBM
1 tenaglia per cementisti 250 mm	1098PL
1 cesoia a doppia leva dritta	1122
1 forbici per elettricisti lame dritte	1128BMX
1 pinze universali a grande effetto, finitura industriale \equiv 180 mm	1150GBM
1 giravite Dzus® \bullet	1201E/DZ
4 giravite lama piatta \bullet 3x75 - 4x100 - 5,5x150 - 6,5x150 mm	1260
1 giravite nano lama piatta \bullet 4x30 mm	1260N
2 giravite lama piatta con esagono di manovra \bullet 10x175 - 12x200 mm	1260E
3 giravite per viti con impronta a croce Phillips® \oplus PH0x60 - PH1x80 - PH2x100 mm	1262
1 giraviti nano Phillips® \oplus PH1x30 mm	1262N
1 giravite Phillips® con esagono di manovra \oplus PH3x175 mm	1262E
7 chiave maschio per viti con impronta Torx® \otimes T6 - T8 - T10 - T15 - T20 - T25 - T30	1267TX
1 tasso a virgola 1350 g	1303
1 tasso curvo	1305
1 tasso a tacco bombato	1306
1 tasso a rotaia	1310
1 tasso a teste tonde convessa e piana	1314
1 leva a cazzuola	1326
1 leva a cucchiaino pesante	1327
1 leva a gomito e piana	1330
1 lima e portailima	1338A
1 scalpello extrapiatto con paramano	1342PM
1 martello con testa tonda e penna	1345
1 martello con testa tonda e quadra Ø 40 mm	1357Z/45
1 martello tipo tedesco 300 g	1370
1 mazzuola con battenti in materiale plastico Ø 35 mm	1390
1 flessometro 5 m	1692



5905VG/1

2.175,00 059051058

Assortimento consigliato in abbinamento con C25



5905VG/2

assortimento di 118 utensili

► Autoriparazione

N. pezzi/Descrizione	Beta N.
6 2 punzoni, 1 bulino, 2 scalpelli piatti e 1 ugnetto in busta avvolgibile in poliestere	38/B6N
13 chiavi combinate 6+14 - 17 - 19 - 22 - 24 mm	42
13 chiavi a forchetta 6x7 - 8x9 - 10x11 - 12x13 - 14x15 - 16x17 - 18x19 - 20x22 - 21x23 - 24x26 - 25x28 - 27x29 - 30x32 mm	55
3 chiavi poligonali doppie starter 11x13 - 14x17 - 19x22 mm	83
10 chiavi maschio esagonale piegate \odot 1,5+12 mm	96N/B10
6 chiavi maschio con impugnatura per viti con impronta Torx® \odot T10 - T15 - T20 - T25 - T30 - T40	97TTX
2 chiavi a bussola Macchina 1/2" \odot 17 - 19 mm	720
20 chiavi a bussola esagonali 1/2" \odot 10+24 - 26 - 27 - 28 - 30 - 32 mm	920A
1 prolunga - 1/2" 125 mm	920/21
1 prolunga - 1/2" 255 mm	920/22
1 snodo 1/2"	920/25
1 quadro maschio 1/2" con spina scorrevole	920/42
1 cricchetto reversibile 1/2" \odot	920/55
8 chiavi a T con bussola snodata \odot 7 - 8 - 10 - 11 - 13 - 14 - 17 - 19 mm	952
1 chiavi a T con bussola snodata per candele	959
1 \odot 17x19x22x 1/2"	979
1 pinze becchi dritti per anelli elastici, per fori \odot 180 mm	1032
1 pinze becchi piegati per anelli elastici, per fori \odot 170 mm	1034
1 pinze becchi dritti per anelli elastici, per alberi \bullet 175 mm	1036
1 pinze becchi piegati per anelli elastici, per alberi \bullet 175 mm	1038
1 pinze regolabili cerniera chiusa 250 mm	1048N
1 pinza autobloccante 240 mm	1052
1 tronchesi a grande effetto, a taglienti diagonali, finitura industriale ζ 160 mm	1084GBM
1 cesoia a doppia leva dritta 250 mm	1122
1 forbici per elettricisti lame dritte	1128BMX
1 pinze universali a grande effetto, finitura industriale \equiv 180 mm	1150GBM
1 pinze a becchi mezzotondi lunghissimi, dritti zigrinati, impugnatura bimatereale, finitura industriale \bullet 160 mm	1166GBM
8 giravite lama piatta \bullet 2,5x50 - 3x75 - 3,5x100 - 4x125 - 5,5x125 - 6,5x150 - 8x200 - 10x200 mm	1260
2 giravite lama piatta con esagono di manovra \bullet 10x200 - 12x250 mm	1260E
1 giravite nano lama piatta \bullet 6,5x30 mm	1260N
4 giravite per viti con impronta a croce Phillips® \oplus PH0x60 - PH1x80 - PH2x100 - PH3x150 mm	1262
1 martello tipo tedesco 400 g	1370
1 mazzuola con battenti in materiale plastico \varnothing 35 mm	1390
1 chiave regolabile a nastro per filtri olio	1491
1 provatensione 3+48 V	1498



5905VG/2

2.040,00 059051044

Assortimento consigliato in abbinamento con C25

5908VG/2T

assortimento di 214 utensili in termoformato rigido in ABS

► Autoriparazione

N. pezzi/Descrizione



T05 T06 T31



T80 T145 T146



T167 T168
+96N +1771



T63 T209



T55 T111 T113 T236



T264 T234 T153 T138



T105 T106 VP6



- 16 chiavi combinate 6÷21 mm
- 5 chiavi combinate 22 - 24 - 27 - 30 - 32 mm
- 5 cacciaspina Ø 2 - 3 - 4 - 5 - 6 mm
- 1 bulino Ø 4 mm
- 12 chiavi a forchetta 6x7 - 8x9 - 10x11 - 12x13 - 14x15 - 16x17 - 18x19 - 20x22 - 21x23 - 24x26 - 27x29 - 30x32 mm
- 9 chiavi maschio esagonale piegate ○ 1,5 - 2 - 2,5 - 3 - 4 - 5 - 6 - 8 - 10 mm
- 5 chiavi a bussola maschio esagonale 1/2" ○ 5 - 6 - 8 - 10 - 12 mm
- 1 prolunga - 1/2" 125 mm
- 1 prolunga - 1/2" 255 mm
- 1 snodo 1/2"
- 1 quadro maschio 1/2" con spina scorrevole
- 1 cricchetto reversibile 1/2" ⊕
- 19 chiavi a bussola esagonali 1/2" ○ 10+24 - 26 - 27 - 30 - 32 mm
- 1 pinze becchi dritti per anelli elastici, per fori ○ 180 mm
- 1 pinze becchi piegati per anelli elastici, per fori ○ 170 mm
- 1 pinze becchi dritti per anelli elastici, per alberi ● 175 mm
- 1 pinze becchi piegati per anelli elastici, per alberi ● 175 mm
- 1 pinze becchi dritti per anelli elastici, per fori ○ 140 mm
- 1 pinze becchi dritti per anelli elastici, per fori ○ 225 mm
- 1 pinze becchi dritti per anelli elastici, per alberi ● 140 mm
- 1 pinze becchi dritti per anelli elastici, per alberi ● 225 mm
- 9 giravite lama piatta ● 3x75 - 3x100 - 4x100 - 4x150 - 5,5x100 - 5,5x150 - 6,5x150 - 8x150 - 10x200 mm
- 2 giravite nano lama piatta ● 4x30 - 6,5x30 mm
- 7 giravite per viti con impronta a croce Phillips® ⊕ PH0x60 - PH0x100 - PH1x80 - PH1x120 - PH2x100 - PH2x150 - PH3x150 mm
- 2 giravite nano Phillips® ⊕ PH1x30 - PH2x30 mm
- 8 chiavi a T con bussola snodata ○ 7 - 8 - 10 - 12 - 13 - 14 - 17 - 19 mm
- 2 giravite lungo Phillips® ⊕ PH1x400 - PH2x400 mm
- 3 giravite lungo lama parallela ● 3x300 - 4x400 - 5x400 mm
- 6 chiavi maschio con impugnatura per viti con impronta Torx® ⊕ T10-T15-T20-T25-T27-T30
- 12 chiavi a bussola Macchina 1/2" ○ 10-13-17-18-19-21-22-24-27-30-32 mm
- 1 prolunga Macchina con attacchi quadri maschio e femmina 1/2" 125 mm
- 3 chiavi a bussola Macchina per dadi ruote ○ 17-19-21
- 5 chiavi a bussola maschio esagonale 1/2" ○ 5L - 6L - 7L - 8L - 10L
- 4 chiavi a bussola maschio per viti con impronta Torx® 1/2" ⊕ T40L - T45L - T55L - T70L
- 3 chiavi a bussola maschio a profilo XZN® ○ M6L - M8L - M12L
- 5 lime a taglio mezzodolce 200 mm
- 1 chiave regolabile a nastro per filtri olio 110 mm
- 1 chiave a bussola quadrata per tappi olio motore ■ 10 mm
- 7 chiavi a bussola maschio esagonale per tappi olio motore ○ 8-9-10-11-12-14-17 mm
- 4 chiavi a bussola maschio quadrato per tappi olio motore ○ 8-9,5-12-13 mm
- 1 chiave a bussola maschio triangolare per tappi olio motore Δ
- 1 chiave a bussola maschio con profilo XZN® per tappi olio motore ○
- 1 chiavi per tappi olio motore
- 2 scalpelli piatti nervati 100 - 200 mm
- 1 martello tipo tedesco 300 g
- 1 mazzuola con battenti in materiale plastico Ø 35 mm
- 1 pinze regolabili cerniera chiusa 250 mm
- 1 pinza autobloccante 240 mm
- 1 pinza universale ■ 180 mm
- 1 pinza a becchi mezzotondi dritti ● 160 mm
- 1 tronchesi a grande effetto taglienti diagonali ⚡ 160 mm
- 11 chiavi a bussola esagonali 3/4" ○ 22-24-27-30-32-34-36-38-41-46-50 mm
- 1 prolunga - 3/4" 200 mm
- 1 prolunga - 3/4" 380 mm
- 1 quadro maschio 3/4" con spina scorrevole 450 mm
- 1 cricchetto reversibile 3/4" ⊕
- 1 termoformato vuoto
- 4 chiavi maschio esagonale piegate ○ 13-14-17-19 mm
- 1 chiave regolabile a rullino 300 mm
- 1 leva piatta curva con impugnatura
- 1 cesoia a lame larghe diritte 250 mm
- 1 forbici per elettricisti lame diritte
- 1 martello tipo tedesco 1000 g
- 1 spessimetro
- 1 magnete telescopico punta flessibile
- 1 specchietto telescopico
- 1 raschietto a tre taglienti 200 mm
- 1 seghetto 440 mm
- 1 spazzola fili d'acciaio
- 1 oliatore in metallo a pressione 200 cl
- 1 cutter con lama a settori

Beta N.	TR
42	T05
42	T06
31	T31
32	T31
55	T31
96N/SC9	T31
920ME	T80
920/21	T80
920/22	T80
920/25	T80
920/42	T80
920/55	T80
920A	T80
1032	T145
1034	T145
1036	T145
1038	T145
1032	T146
1032	T146
1036	T146
1036	T146
1260	T167
1260N	T167
1262	T168
1262N	T168
952	T63
1262L	T209
1264L	T209
97TTX	T55
720	T111
720/21	T111
720/LC	T111
920PE	T113
920TX	T113
920XZN	T113
1719BMA8/S5	T236
1491	T264
1494	T264
1494E	T264
1494Q	T264
1494T	T264
1494XZN	T264
1496/C	T264
35	T234
1370	T234
1390	T234
1048N	T153
1052	T153
1150	T138
1166	T138
1084	T138
928A	T105
928/21	T106
928/22	T106
928/42	T106
928/55	T106
VP6	VP6
96N	VP6
111E	VP6
965	VP6
1112	VP6
1128BMX	VP6
1370	VP6
1708/20	VP6
1712	VP6
1715	VP6
1717B	VP6
1726	VP6
1737NX	VP6
1751N	VP6
1771	VP6

5908VG/2T

€ 4.140,00 059081017

Assortimento consigliato in abbinamento con RSC28



MB12



MB39



MB46

5935VG/1MB

assortimento di 98 utensili per cassettera C35, in vassoio morbido in EVA

► Autoriparazione

N. pezzi/Descrizione

- 21 chiavi combinate 6-7-8-9-10-11-12-13-14-15-16-17-18-19-20-21-22-24-27-30-32 mm
- 8 chiavi a forchetta 6x7-8x9-10x11-12x13-14x15
16x17-18x19-20x22 mm
- 1 pinze regolabili cerniera chiusa 250 mm
- 4 giravite lama piatta ● 3x75-4x100-5x125-6,5x150 mm
- 3 giravite per viti con impronta a croce Phillips® ● PH0x60-PH1x80--PH2x100 mm
- 6 chiave maschio per viti con impronta Torx® ● T8-T10-T15-T20-T25-T30
- 9 chiavi maschio esagonale piegate con estremità sferica ○
- 6 chiavi maschio esagonale con impugnatura ○ 2-2,5-3-4-5-6
- 1 pinza autobloccante 240 mm
- 19 chiavi a bussola esagonali 1/2" ○ 10-11-12-13-14-15-16-17-18-19-20
21-22-23-24-26-27-30-32 mm
- 1 prolunga - 1/2" 125 mm
- 1 prolunga - 1/2" 250 mm
- 1 snodo 1/2"
- 1 quadro maschio 1/2" con spina scorrevole
- 1 cricchetto reversibile 1/2" ●
- 5 chiavi a bussola maschio esagonale 1/2" ○ 5-6-8-10-12 mm
- 1 pinze becchi dritti per anelli elastici, per fori ○ 180 mm
- 1 pinze becchi piegati per anelli elastici, per fori ○ 170 mm
- 1 pinze becchi dritti per anelli elastici, per alberi ● 175 mm
- 1 pinze becchi piegati per anelli elastici, per alberi ● 175 mm
- 1 scalpelli piatti nervati 200 mm
- 1 tronchesi a grande effetto taglienti diagonali ✂ 160 mm
- 1 pinza universale = 180 mm
- 1 pinza a becchi mezzotondi dritti ● 160 mm
- 1 martello tipo tedesco 500 g
- 1 mazzuola con battenti in materiale plastico 35 mm

Beta N.	TR
42	MB12
55	MB12
1048N	MB12
1260	MB46
1262	MB46
1267TX	MB46
96BPC/SC9	MB46
96T	MB46
1052	MB46
920A	MB39
920/21	MB39
920/22	MB39
920/25	MB39
920/42	MB39
920/55	MB39
920PE	MB39
1032	MB39
1034	MB39
1036	MB39
1038	MB39
35	MB39
1084BM	MB39
1150BM	MB39
1166BM	MB39
1370	MB39
1390	MB39

5935VG/1MB € 1.740,00 059351321

Assortimento consigliato in abbinamento con C35

5940SBK

assortimento di 125 utensili

► Motoriparazione

N. pezzi/Descrizione

- 1 punzoni Ø 2 mm
- 1 bulino Ø 4 mm
- 1 scalpelli piatti 125 mm
- 10 chiavi combinate 6 - 7 - 8 - 10 - 11 - 12 - 13 - 14 - 17 - 19 mm
- 6 chiavi a forchetta 6x7 - 8x9 - 10x11 - 12x13 - 14x15 - 16x17 mm
- 9 chiavi maschio esagonale piegate ○ 1,5 - 2 - 2,5 - 3 - 4 - 5 - 6 - 8 - 10 mm
- 1 chiavi dinamometriche a scatto ZERO-RESET ● 3/8", 10÷50 Nm
- 54 Assortimento di 52 inserti con attacco esagonale 10 mm e 2 accessori
- 17 assortimento di 12 chiavi a bussola e 5 accessori
- 1 raccordo quadro maschio 1/2" e femmina 3/8"
- 2 chiavi a bussola per candele ○ 14 - 16 mm
- 1 pinza a becchi mezzotondi lunghissimi ● 283 mm
- 2 pinze becchi dritti per anelli elastici, per fori ○ 140 - 180 mm
- 1 pinze becchi dritti per anelli elastici, per alberi ● 140x1,3 mm
- 1 tronchesi a taglienti diagonali, finitura industriale ✂ 160 mm
- 1 forbici per elettricisti lame dritte
- 1 pinze universali a grande effetto, finitura industriale = 180 mm
- 1 giravite Dzus® ●
- 4 giravite lama piatta ● 3x75 - 4x100 - 5,5x100 - 6,5x150 mm
- 3 giravite Phillips® ● PH0x60 - PH1x80 - PH2x100 mm
- 1 giravite provacircuito ●
- 1 martello tipo tedesco 300 g
- 1 chiave regolabile a nastro per filtri olio
- 1 spessimetro
- 1 miniseghetto
- 1 spazzola fili d'ottone
- 1 oliatore in plastica a pressione 250 cc

Beta N.	
30	
32	
34	
42	
55	
96/SC9	
666/5	
867/C52	
920A/C12X	
910/16	
956C	
1009L/A	
1032	
1036	
1082G	
1128BM	
1150G	
1201E/DZ	
1201E	
1202E	
1254	
1370	
1491	
1708/13	
1725CR	
1737	
1754	

5940SBK € 1.300,00 059401082

Assortimento consigliato in abbinamento con C41H - C41S - C42H

5941VU/M

assortimento di 64 utensili per trolley C41H, in vassoio morbido in EVA

► Universali

N. pezzi/Descrizione

- 16 chiavi combinate 6-7-8-9-10-11-12-13-14-15-16-17-18-19-21-22 mm
- 9 chiavi maschio esagonale piegate ○
- 1 flessometro 5 m
- 19 chiavi a bussola esagonali 1/2" ○ 10-11-12-13-14-15-16-17-18-19-20-21-22-23-24-26-27-30-32 mm
- 1 snodo 1/2"
- 1 quadro maschio 1/2" con spina scorrevole
- 1 cricchetto reversibile 1/2" ⊕
- 2 prolunga angolare - 1/2" 125-250 mm
- 1 chiave regolabile a rullino 250 mm
- 1 pinze regolabili cerniera chiusa 250 mm
- 1 tronchesi a taglienti diagonali, finitura industriale \nlessgtr 160 mm
- 1 forbici per elettricisti lame diritte 145 mm
- 1 pinze universali a grande effetto, finitura industriale \equiv 180 mm
- 1 pinze a becchi mezzotondi lunghissimi, diritti zigrinati, impugnatura bimatereale, finitura industriale ● 160 mm
- 3 giravite lama piatta ● 3,5x100-5,5x125-6,5x150 mm
- 3 giravite per viti con impronta a croce Phillips® ⊕ PH0-PH1-PH2
- 1 martello tipo tedesco 300 g
- 1 cutter con lama a settori 18 mm

Beta N.	TR
42	MC12
96/SC9	MC12
1692/5	MC12
920A	MC21
920/25	MC21
920/42	MC21
920/55	MC21
920AN	MC21
111E	
1048N	
1082GBM	
1128BMX	
1150GBM	
1166GBM	
1260	
1262	
1370	
1771	



MC21



MC12



5941VU/M

€ 879,00 059411002

Assortimento consigliato in abbinamento con C41H

5945VUM

assortimento di 199 utensili in vassoio morbido in EVA

► Universali

N. pezzi/Descrizione

- 21 chiavi combinate 6-7-8-9-10-11-12-13-14-15-16-17-18-19-20-21-22-24-27-30-32 mm
 9 chiavi maschio esagonale piegate con estremità sferica \odot 1,5-2-2,5-3-4-5-6-8-10 mm
 1 bussola portainseri \square 1/4 - \square 1/4
 1 bussola portainseri \square 1/4 - \square 3/8
 1 bussola portainseri \square 5/16 - \square 1/2
 13 chiavi a bussola esagonali 1/4" \odot 4-4,5-5-5,5-6-7-8-9-10-11-12-13-14 mm
 9 chiavi a bussola a mano lunghe bocca esagonale \odot 5-6-7-8-9-10-11-12-13 mm
 5 chiavi a bussola maschio esagonale 1/4" \odot 3-4-5-6-7 mm
 4 chiavi a bussola a giravite per viti con intaglio 1/4" \bullet 0,8x4-1x5,5x1,2x6,5-1,2x8 mm
 4 chiavi a bussola a giravite per viti con impronta a croce Phillips® 1/4" \oplus PH1-PH2-PH3-PH4
 7 chiavi a bussola a giravite maschio per viti con impronta Torx® \odot T10-T15-T20-T25-T27-T30-T40
 1 raccordo con attacco quadro \square 1/4 - \blacksquare 3/8
 1 prolunga - 1/4" 50 mm
 1 prolunga - 1/4" 100 mm
 1 prolunga - 1/4" 150 mm
 1 snodo 1/4"
 1 quadro con impugnatura 1/4" 176 mm
 1 quadro scorrevole 1/4" 115 mm
 1 cricchetto reversibile 1/4" \otimes 125 mm
 17 chiavi a bussola esagonali 3/8" \odot 6-7-8-9-10-11-12-13-14-15-16-17-18-19-20-21-22 mm
 1 raccordo con attacco quadro \square 3/8 - \blacksquare 1/4
 1 raccordo quadro maschio 1/2" e femmina 3/8" \square 3/8 - \blacksquare 1/2
 1 prolunga - 3/8" 125 mm
 1 prolunga - 3/8" 250 mm
 1 snodo 3/8"
 1 quadro maschio 3/8" con spina scorrevole 210 mm
 1 cricchetto reversibile 3/8" \otimes 200 mm
 21 chiavi a bussola esagonali 1/2" \odot 8-10-11-12-13-14-15-16-17-18-19-20-21-22-23-24-26-27-28-30-32 mm
 1 raccordo con attacco quadro \square 1/2 - \blacksquare 3/8
 1 snodo 1/2"
 1 prolunga angolare - 1/2" 125 mm
 1 prolunga angolare - 1/2" 250 mm
 1 quadro maschio 1/2" con spina scorrevole 305 mm
 1 cricchetto reversibile 1/2" \otimes 275 mm
 3 chiavi a bussola per candele 3/8" \odot 16 mm (5/8")-17,8 (11/16")-20,8 (13/16")
 6 giravite lama piatta \bullet 0,4x2,5x50-0,5x3x75-0,8x4x100-1,0x5,5x125-1,2x6,5x150-1,2x8x200 mm
 1 giravite per viti a testa con intaglio \bullet 0,8x4x30 mm
 4 giravite Phillips® \oplus PH0x60-PH1x80PH2x100PH3x150 mm
 1 giravite Phillips® \oplus PH1x30 mm
 12 chiavi maschio con impugnatura per viti con impronta Torx®
 \odot T06-T07-T08-T09-T10-T15-T20-T25-T27-T30-T40-T45
 1 giravite cercafase \bullet 0,5x3,5x100 mm
 1 pinze becchi dritti per anelli elastici, per fori \odot 180 mm
 1 pinze becchi piegati per anelli elastici, per fori \odot 170 mm
 1 pinze becchi dritti per anelli elastici, per alberi \bullet 175 mm
 1 pinze becchi piegati per anelli elastici, per alberi \bullet 175 mm
 1 pinze regolabili cerniera chiusa 250 mm
 1 pinza autobloccante 240 mm
 1 pinza autobloccante 240 mm
 1 tronchesi a taglienti diagonali \leq 160 mm
 1 tenaglie per cementisti 220 mm
 1 forbici per elettricisti lame dritte
 1 pinza universale \equiv 180 mm
 1 pinza a becchi mezzotondi dritti \bullet 160 mm
 3 punzoni \varnothing 2-3-4 mm
 6 cacciaspina \varnothing 2-3-4-5-6-8 mm
 1 bulino \varnothing 4 mm
 1 scalpelli piatti 150 mm
 2 scalpelli piatti nervati 200-250 mm
 1 ugnetti 125 mm
 1 martello tipo tedesco 500 g
 1 mazzuola con battenti in materiale plastico \varnothing 35 mm
 1 flessometro 3 m
 1 magnete telescopico con testa flessibile
 1 lima 200 mm
 1 lima 200 mm
 1 lima 200 mm
 1 lima 200 mm
 1 lima 200 mm
 1 spazzola fili d'acciaio
 1 cutter con lama a settori

Beta N.	TR
42	MM11
96BPC/SC9	MM11
895/1	MM105
895/3	MM105
895/6	MM105
900	MM105
900L	MM105
900ME	MM105
900LP	MM105
900PH	MM105
900TX	MM105
900/16	MM105
900/20	MM105
900/20L	MM105
900/21	MM105
900/25	MM105
900BG/30	MM105
900/42	MM105
900/55	MM105
910A	MM105
910/15	MM105
910/16	MM105
910/21	MM105
910/22	MM105
910/25	MM105
910/42	MM105
910/55	MM105
920A	MM105
920/15	MM105
920/25	MM105
920AN	MM105
920AN	MM105
920/42	MM105
920/55	MM105
956E	MM105
1201E	MM210
1201EN	MM210
1202E	MM210
1202EN	MM210
1207E/TX	MM210
1253	MM210
1032	MM129
1034	MM129
1036	MM129
1038	MM129
1048N	MM129
1052	MM129
1052	MM129
1082BM	MM129
1098	MM129
1128BM	MM129
1150BM	MM129
1166BM	MM129
30	MM230
31	MM230
32	MM230
34	MM230
35	MM230
36	MM230
1370	MM230
1390	MM230
1692	MM230
1712TF	MM230
1719BMA...Q	MM230
1719BMA...T	MM230
1719BMA...P	MM230
1719BMA...M	MM230
1719BMA...R	MM230
1737NX	MM230
1771	MM230



MM11



MM105



MM129



MM210



MM230



5945VUM 2.820,00 059451011

Assortimento consigliato in abbinamento con C45PRO



5954VG

assortimento di 138 utensili - accessori di fissaggio inclusi

► Autoriparazione

N. pezzi/Descrizione	Beta N.
5 cacciaspina Ø 2-3-4-5-6 mm	31
1 bulino Ø 4 mm	32
1 scalpelli piatti 125 mm	34
18 chiavi combinate 6+22 - 24 mm	42
8 chiavi a forchetta 6x7 - 8x9 - 10x11 - 12x13 - 14x15 16x17 - 18x19 - 20x22 mm	55
3 chiavi poligonali curve 12x13 - 14x15 - 17x19 mm	90
13 chiavi maschio esagonale piegate ○ 2+10 - 12 mm	96
4 chiavi a bussola Macchina 1/2" ○ 17 - 19 - 21 - 22 mm	720
20 chiavi a bussola esagonali 1/2" ○ 10-11-12-13-14-15-16-17-18-19-20- 21-22-23-24-26-27-28-30-32 mm	920A
1 prolunga - 1/2"	920/21
1 prolunga - 1/2"	920/22
1 snodo 1/2"	920/25
1 quadro maschio 1/2" con spina scorrevole	920/42
1 cricchetto reversibile 1/2" Ⓞ	920/55
3 chiavi a bussola con impugnatura, tipo lungo ○ 8 - 10 - 13 mm	943BX
10 chiavi a T con bussola snodata ○ 6 - 7 - 8 - 10 - 11 - 12 - 13 - 14 - 17 - 19 mm	952
3 chiavi a bussola per candele ○ 16 - 17,8 - 20,8 mm	956C
1 leva con estremità a punta e a becco	964
1 pinze becchi dritti per anelli elastici, per fori ○	1032
1 pinze becchi piegati per anelli elastici, per fori ○	1034
1 pinze becchi dritti per anelli elastici, per alberi ●	1036
1 pinze becchi piegati per anelli elastici, per alberi ●	1038
1 pinza regolabili cerniera chiusa 250 mm	1048N
1 pinza autobloccante 240 mm	1052
1 pinza autobloccante becchi lunghi 175 mm	1058
1 tronchesi a taglienti diagonali 160 mm	1082BM
1 forbici per elettricisti lame diritte	1128BMX
1 pinza universale = 180 mm	1150BM
1 pinza a becchi mezzotondi dritti ● 160 mm	1166BM
1 giravite provacircuito ● 6+24V	1254
1 giravite lama piatta ● 8 x 200 mm	1260
1 giravite nano lama piatta ● 6,5x30 mm	1260N
1 giravite per viti con impronta a croce Phillips® ● 8 x 150 mm	1262
1 giraviti nano Phillips® ● PH2x30 mm	1262N
5 chiave maschio per viti con impronta Torx® ○ T8 - T10 - T15 - T20 - T25	1267TX
8 giravite	1263/D8
1 martello tipo tedesco 300 g	1370
1 mazzuola antirimbalzo Ø 35 mm	1392
1 pinza molle freni 210 mm	1470
1 pinza per capicorda non isolati	1603
1 flessometro 5 m	1692
1 spessimetro	1708/20
1 flessibile magnetico 1,8 kg	1712E/2
6 lime ad ago 160 mm	1720/B6
1 oliatore in plastica a pressione 150 cc	1754



5954VG

2.405,00 059541054

Assortimento consigliato in abbinamento con C54S



5957VG

assortimento di 174 utensili - accessori di fissaggio inclusi

► Autoriparazione

N. pezzi/Descrizione	Beta N.
6 cacciaspina Ø 2 - 3 - 4 - 5 - 6 - 8 mm	31/SP6
6 punzoni, 1 bulino, 3 scalpelli con supporto	38/SP6
17 chiavi combinate 6-7-8-10-11-12-13-14-15-16-17 19-21-22-24-27-30 mm	42
12 chiavi a forchetta 6x7 ÷ 30x32 mm	55/S12X
8 chiavi maschio esagonale con impugnatura 2 ÷ 10 mm	96T/S8
1 chiavi maschio esagonale piegate Ø 2,5 ÷ 12 mm	96N/G7
8 chiavi maschio piegate per viti con impronta Torx® T9 + T40 chiavi a profilo XZN®, cromate Ø M5 + M12	97TX/SC8 98XZN/B5
1 chiave regolabile a rullino 250 mm	111E
1 chiavi dinamometriche a scatto ZERO-RESET 1/2", 40÷200 Nm	666/20
13 chiavi a bussola esagonali 1/2" con guida Ø 10÷22 mm	920A/SB13
8 chiavi a bussola esagonali 1/2" con guida Ø 23÷32 mm	920A/SB8
4 chiavi a bussola a giravite lama piatta 1/2" ● 1,2x6,5 - 1,2x8 - 1,6x8 - 2x12 mm	920LP
3 chiavi a bussola a giravite lama Phillips® 1/2" ⊕ PH2 - 3 - 4	920PH
1 prolunga - 1/2" 125 mm	920/21
1 prolunga - 1/2" 255 mm	920/22
1 snodo 1/2"	920/25
1 quadro maschio 1/2" con spina scorrevole	920/42
1 cricchetto reversibile 1/2" ⊗	920/55
2 chiavi a bussola Macchina 1/2" ○ 17 - 19 mm	720
10 chiavi a T con bussola snodata ○ 7 - 8 - 10 - 11 - 12 - 13 - 14 - 15 - 17 - 19 mm	952
3 chiavi a T con bussola snodata per candele 14 - 16 - 20,8 mm	959
1 leva con estremità a punta e piatta curva	963
1 ○ ■ 1/2" - 17 - 19 - 22 mm	979
2 pinze becchi dritti per anelli elastici, per fori ○ 140 - 180 mm	1032
2 pinze becchi piegati per anelli elastici, per fori ○ 130 - 170 mm	1034
2 pinze becchi dritti per anelli elastici, per alberi ● 140x1,3 - 175 mm	1036
2 pinze becchi piegati per anelli elastici, per alberi ● 135x1,3 - 175 mm	1038
1 pinze regolabili cerniera chiusa 250 mm	1048N
1 pinza autobloccante 240 mm	1052
1 tronchesi a taglianti diagonali ✂ 160 mm	1082BM
1 tronchesi a grande effetto taglianti diagonali ✂ 160 mm	1084BM
1 tronchesi doppia leva taglio frontale ✂ 180 mm	1092V
1 cesoia a lame larghe diritte 250 mm	1112
1 forbici per elettricisti lame diritte	1128BMX
1 pinza universale = 180 mm	1150BM
1 pinza a becchi mezzotondi dritti ● 160 mm	1166BM
1 pinza a becchi mezzotondi piegati ● 200 mm	1168BM
2 giravite lama piatta ● 8x200 - 10x200 mm	1260
1 giravite per viti con impronta a croce Phillips® ⊕ PH3x150 mm	1262
8 giravite	1263/D8
2 martello tipo tedesco 300 - 600 g	1370
1 mazzuola con battenti in materiale plastico Ø 35 mm	1390
11 estrattori a rulli per viti prigioniere M5+M16 mm	1433/C11
1 chiave regolabile a nastro per filtri olio	1491
1 provatensione	1498
1 flessometro 5 m	1692
1 spessimetro	1708/20
1 flessibile magnetico 1,8 kg	1712E/2
1 raschietto a due taglianti 200 mm	1717A
1 raschietto a tre taglianti 200 mm	1717B
5 lime a taglio mezzodolce 200 mm	1719BMA8/S5
1 seghetto	1725
1 oliatore in metallo a pressione 200 cc	1751
1 cutter con lama a settori	1771
1 calibro a corsoio	1650



5957VG

4.190,00 059571007

Assortimento consigliato in abbinamento con C57SA - C57SB - C57SP - C55PS - C55PSE

MODULI MORBIDI

Assortimenti di utensili in moduli morbidi per cassettiere e carrelli.



RSC23T
RSC24
RSC24A
RSC24AXL
RSC24L/7
RSC24L-CAB
RSC28
C30M
C37
C37A
C39
C39T
C39MD
C39SM
RSC51
C57S
C59
RSC55

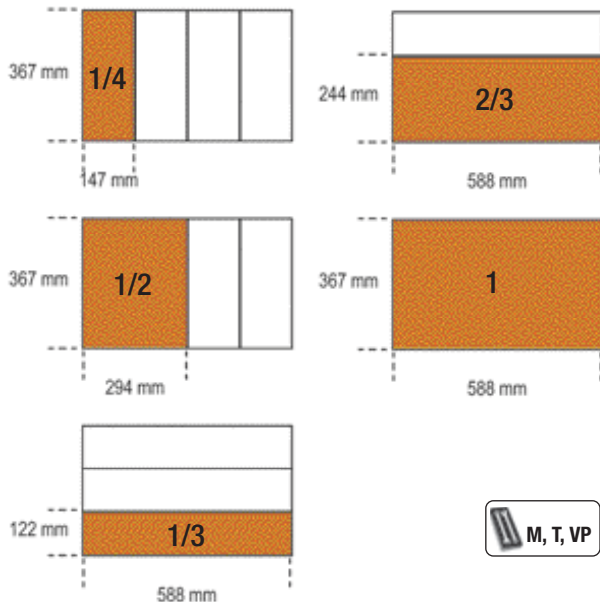

M, T, VP

533÷543
549÷558

M01



42 6-7-8-9-10-11-12-13-14-15-16-17-18-19-20-21-22-24-27-30-32-36 mm

4,5 kg

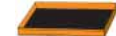

M01 € 452,00 1 024500001
MV10 € 69,00 1 024510010

M02



42 6-7-8-9-10-11-12-13-14-15-16-17-18-19-20-21-22-23-24-25-26-27-28-29-30-32 mm

6,3 kg



M02 € 512,00 1 024500002
MV02 € 69,00 1 024510002

M05



42 6-7-8-9-10-11-12-13-14-15-16-17-18-19-20-21 mm

1,5 kg



M05 € 222,50 1 024500005
MV15 € 36,00 1 024510015

M06



42 22-24-27-30-32 mm

2,1 kg



M06 € 158,00 1 024500006
MV16 € 49,00 1 024510016

M13



42SLIM 8-10-11-12-13-14-15-16-17-18-19 mm

1,2 kg



M13 € 165,50 1 024500013
MV13 € 36,00 1 024510013

M25



42 6-7-8-9-10-11-12-13-14-15-16-17-18-19-21-22-24-27 mm
90 6x7-8x9-10x11-12x13-14x15-16x17-18x19 mm
123Q1/4
123Q3/8
123Q1/2
142 8-9-10-11-12-13-14-15-16-17-18-19 mm

5,1 kg



M25 € 727,00 1 024500025
MV25 € 69,00 1 024510873

M30



55 6x7-8x9-10x11-12x13-14x15-16x17-18x19-20x22-21x23-24x27-30x32 mm
90 6x7-8x9-10x11-12x13-14x15-16x17-18x19-20x22-21x23-24x27-30x32 mm
Ø96BPC/SC9 1,5-2-2,5-3-4-5-6-8-10 mm

4,2 kg



M30 € 421,00 1 024500030
MV30 € 69,00 1 024510030



M31

27

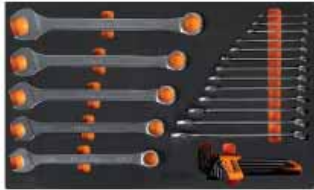

42AS 1/4 - 9/32 - 5/16 - 3/8 - 7/16 - 1/2 - 9/16 - 19/32 - 5/8 - 11/16 - 3/4 - 13/16 - 7/8 - 15/16 - 1 - 1.1/16 - 1.1/8 - 1.1/4

○ **96BP/AS-SC9** 1/16 - 3/32 - 1/8 - 5/32 - 3/16 - 7/32 - 1/4 - 5/16 - 3/8

5,7 kg

M31 440,00 € 1 024500031
MV31 69,00 € 1 024510031

M33

17



55 6x7-8x9-10x11
 12x13-14x15
 16x17-18x19
 20x22 mm

○ **96/SC9** 1,5+10 mm

1,1 kg

M33 102,00 € 1 024500033
MV33 36,00 € 1 024510033

M38

4



55 21x23-24x26
 27x29-30x32 mm

1,7 kg

M38 86,00 € 1 024500038
MV38 49,00 € 1 024510038

M39

36



31 2-3-4-5-6-8 mm
32 4 mm
55 6x7 - 8x9 - 10x11 - 12x13 - 14x15 - 16x17 - 18x19 - 20x22 - 21x23 - 24x26 - 25x28 - 27x29 - 30x32 mm

○ **96/SC12** 2 - 2,5 - 3 - 3,5 - 4 - 4,5 - 5 - 6 - 7 - 8 - 9 - 10 mm

○ **96** 12-14-17-19 mm

5,7 kg

M39 346,00 € 1 024500039
MV39 69,00 € 1 024510039

M40

7



90 6x7-8x9-10x11
 12x13-14x15
 16x17-18x19 mm

810 g

M40 113,50 € 1 024500040
MV40 36,00 € 1 024510040

M44

12



141 8-9-10-11-12
 13-14-15-16
 17-18-19 mm

1,3 kg

M44 287,00 € 1 024500044
MV44 36,00 € 1 024510044

M45

12



142 8-9-10-11-12
 13-14-15-16
 17-18-19 mm

1,3 kg

M45 327,00 € 1 024500045
MV45 36,00 € 1 024510045

M46

12



142SN 8-9-10-11-12
 13-14-15-16
 17-18-19 mm

1,4 kg

M46 386,00 € 1 024500046
MV46 36,00 € 1 024510046

M49

24

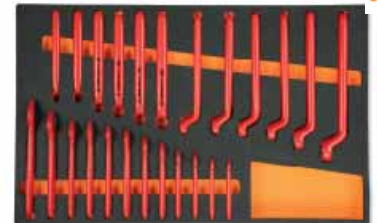

52MQ 7 - 8 - 10 - 11 - 12 - 13 - 14 - 15 - 16 - 17 - 19 - 22 mm

89MQ 7 - 8 - 10 - 11 - 12 - 13 - 14 - 15 - 16 - 17 - 19 - 22 mm

3,3 kg

M49 1.170,00 € 1 024500049
MV49 69,00 € 1 024510049

M50

8



○ **96T** 2-2,5-3-4-5
 6-7-8 mm

1,1 kg

M50 132,50 € 1 024500050
MV50 49,00 € 1 024510051

M52



○ 96T 2,5-3-4-5-6 mm



330 g



M52	78,50 €	1	024500052
MV52	36,00 €	1	024510052

M53



○ 96TBP 2,5-3-4-5-6 mm



350 g



M53	83,00 €	1	024500053
MV52	36,00 €	1	024510052

M55



○ 97TTX T10-T15-T20-T25-T30



330 g



M55	87,00 €	1	024500055
MV55	36,00 €	1	024510055



M60



- 96T 2 - 2,5 - 3 - 4 - 5 - 6 - 7 - 8 - 10 mm
- 97BTX/SC8 T9 - T10 - T15 - T20 - T25 - T27 - T30 - T40
- 944BX 5-6-7-8-10-13 mm

1,9 Kg



M60	387,00 €	1	024500060
MV60	69,00 €	1	024510060

M62



- 97TTX T10 - T15 - T20 - T25 - T27 - T30 - T40 - T45 - T50
- 1032 180 mm
- 1034 170 mm
- 1036 175 mm
- 1038 175 mm
- 1177BM 140 mm
- 1188BM 125 mm
- 1257LP 2-2,5-3-3,5 mm
- 1257PH 0-00

2,3 kg



M62	467,00 €	1	024500875
MV62	69,00 €	1	024510875

M63



○ 952 7 - 8 - 10 - 12 - 13 - 14 - 17 - 19 mm

3,4 kg



M63	351,00 €	1	024500063
MV63	69,00 €	1	024510063

M65

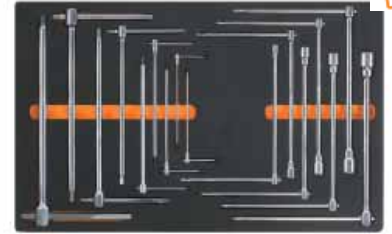

- 950 8 - 10 - 12 - 13 - 14 - 17 - 19 mm
- 951 2,5 - 3 - 4 - 5 - 6 - 8 - 10 - 12 - 14 mm

3,6 Kg



M65	540,00 €	1	024500065
MV65	69,00 €	1	024510065

M67

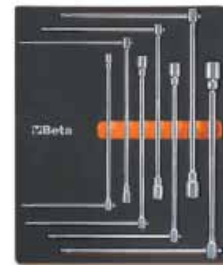

○ 950 7-8-10-12-13-17 mm

1,8 kg



M67	207,50 €	1	024500067
MV67	49,00 €	1	024510067

M69



○ 951 2,5-3-4-5-6-8-10-12-14 mm

1,8 kg



M69	306,00 €	1	024500069
MV69	49,00 €	1	024510069

M75



○ 933 7-8-9-10-11-12-13-14-15-16-17-18-19-21-22-24 mm

5,5 kg



M75	457,00 €	1	024500075
MV75	69,00 €	1	024510075



M78



80 6x7 - 8x9 - 10x11 - 12x13 - 14x15 - 16x17 - 18x19 mm

920/36A

965 450 mm

1052 240 mm

1058 175 mm

1481PL/A

1481PL/B

1481PL/C

1650 150 mm

1708/20

1716P

4,4 kg

M78	704,00 €	1	024500878
MV77	69,00 €	1	024510876

M79



80 8x9 - 10x11 - 12x13 - 14x15 - 16x17 - 18x19 mm

1,3 kg

M79	309,00 €	1	024500079
MV79	36,00 €	1	024510079

M82



920A 10-11-12-13-14 - 15-16-17-18-19 - 20-21-22-23-24 - 26-27-30-32 mm

920ME 5-6-8-10-12 mm

920AN/125 125 mm

920AN/250 250 mm

920/25 255 mm

920/42 305 mm

920/55

4,1 kg

M82	448,00 €	1	024500082
MV82	49,00 €	1	024510082

M83



920A 10-11-12-13-14 - 15-16-17-18-19 - 20-21-22-23-24 - 26-27-30-32 mm

920AN/125 125 mm

920AN/250 250 mm

920/25 255 mm

920/42 305 mm

920/55

3,7 kg

M83	352,00 €	1	024500083
MV83	49,00 €	1	024510083

M85



851SR 230 mm

860LP 0,5x3 - 0,6x4,5 - 0,8x5,5 - 1x5,5 - 1,2x6,5 mm

860PE 2 - 2,5 - 3 - 4 - 5 - 6 - 8 - 10 mm

860PH PH0 - PH1 - PH2 - PH3 - PH4

860PZ PZ1 - PZ2 - PZ3 - PZ4

860TX T6 - T7 - T8 - T9 - T10 - T15 - T20 - T25 - T27 - T30 - T40

860RTX T9 - T10 - T15 - T20 - T25 - T27 - T30 - T40

860/55 100 mm

882P 80 mm

892 1/4 - 1/2 - 3/4

450 g

M85	205,00 €	1	024500085
MV85	36,00 €	1	024510085

M86



867PE 4-5-6-7-8-10-12 mm

867PE/L 4-5-6-7-8-10-12 mm

867XZN 5-6-8-10-12 mm

867XZN/L 5-6-8-10-12 mm

867TX T20 - T25 - T30 - T40 - T45 - T50 - T55

867TX/L T25 - T30 - T40 - T45 - T50 - T55

867RTX T20 - T25 - T30 - T40 - T45 - T50 - T55

867/1

867/2

1,4 kg

M86	147,50 €	1	024500086
MV86	36,00 €	1	024510086

M91



900 4 - 4,5 - 5 - 5,5 - 6 - 7 - 8 - 9 - 10 - 11 - 12 - 13 - 14 mm

900ME 2,5-3-4-5-6-8 mm

900/20 50 mm

900/21 150 mm

900/25 1/4 - 1/2

900BG/30

900/42

900/55

560 g

M91	239,00 €	1	024500091
MV90	36,00 €	1	024510090

M92



910A 6-7-8-9-10-11-12-13 - 14-15-16-17-18-19-20 - 21-22 mm

910/21 125 mm

910/22 250 mm

910/25

910/42

910/55

1,5 kg

M92	271,00 €	1	024500092
MV92	36,00 €	1	024510092

M94



900AS/L 3/16 - 7/32 - 1/4 - 9/32 - 5/16 - 11/32 - 3/8 - 7/16 - 1/2 - 9/16

900AS 3/16 - 7/32 - 5/32 - 1/4 - 9/32 - 5/16 - 11/32 - 3/8 - 7/16 - 1/2 - 9/16

900AN 50-100mm

900/25

900/55

900/42

930 g

M94	280,00 €	1	024500094
MV94	36,00 €	1	024510094

M96



920A/AS 3/8 - 7/16 - 1/2 - 9/16 - 19/32 - 5/8 - 11/16 - 3/4 - 25/32 - 13/16 - 7/8 - 15/16 - 1 - 1.1/16 - 1.1/18 - 1.3/16 - 1.1/4

920/25 125-250mm

920AN

920/42

920/55

3,8 kg

M96	363,00 €	1	024500096
MV96	49,00 €	1	024510096



- 895/1
- 895/3
- 895/6
- 900 4 - 4,5 - 5 - 5,5 - 6 - 7 - 8 - 9 - 10 - 11 - 12 - 13 - 14 mm
- 900L 5 - 6 - 7 - 8 - 9 - 10 - 11 - 12 - 13 mm
- 900ME 3-4-5-6-7 mm
- 900LP 0,8x4 - 1x5,5 - 1,2x6,5 - 1,2x8 mm
- ⊕ 900PH PH1-PH2-PH3-PH4
- ⊕ 900TX T10 - T15 - T20 - T25 - T27 - T30 - T40
- 900/20 50 mm
- 900/20L 100 mm
- 900/21 150 mm
- 900/25
- 900BG/30
- 900/42
- ⊕ 900/55
- 920A 8-10-11-12-13-14-15-16-17-18-19-20-21-22-23-24-26-27-28-30-32 mm
- 920/15
- 920/25
- 920AN/125 125 mm
- 920AN/250 250 mm
- 920/42
- ⊕ 920/55
- 920FTX 10 - 12 - 14 - 16 - 18 - 20 - 22 - 24 mm
- 920AL 10 - 12 - 13 - 14 - 15 - 16 - 17 - 18 - 19 - 21 - 22

6,7 kg

14" 12"



M100	1.225,00 €	1	024500100
MV100	69,00 €	1	024510100



- 900 4 - 4,5 - 5 - 5,5 - 6 - 7 - 8 - 9 - 10 - 11 - 12 - 13 - 14 mm
- 900L 5 - 6 - 7 - 8 - 9 - 10 - 11 - 12 - 13 mm
- 96BPC/SC9 1,5 - 2 - 2,5 - 3 - 4 - 5 - 6 - 8 - 10 mm
- 895/1
- 895/3
- 895/6
- 900ME 3-4-5-6-7 mm
- 900LP 0,8x4 - 1x5,5 - 1,2x6,5 - 1,2x8 mm
- ⊕ 900PH PH1-PH2-PH3-PH4
- ⊕ 900TX T10 - T15 - T20 - T25 - T27 - T30 - T40
- 900/16 □ 1/4 - ■ 3/8
- 900/... 50-100-150 mm
- 900/25
- 900BG/30
- 900/42
- ⊕ 900/55
- 910A 6 - 7 - 8 - 9 - 10 - 11 - 12 - 13 - 14 - 15 - 16 - 17 - 18 - 19 - 20 - 21 - 22 mm
- 910/15 □ 3/8 - ■ 1/4
- 910/16 □ 3/8 - ■ 1/2
- 910/21 125 mm
- 910/22 250 mm
- 910/25
- 910/42
- ⊕ 910/55
- 920A 8 - 10 - 11 - 12 - 13 - 14 - 15 - 16 - 17 - 18 - 19 - 20 - 21 - 22 - 23 - 24 - 26 - 27 - 28 - 30 - 32 mm
- 1/2 - ■ 3/8
- 920/15
- 920/25
- 920AN 125 - 250 mm
- 920/42
- ⊕ 920/55
- 956E 16-17,8-20,8 mm

7,7 kg

14" 38" 12"



M105	1.330,00 €	1	024500871
MV105	69,00 €	1	024510871



- 910MQ/PE 4-5-6-8 mm
- 910MQ/B 7 - 8 - 10 - 11 - 12 - 13 - 14 - 15 - 16 - 17 - 19 mm
- ⊕ 910MQ/TX T15 - T20 - T25 - T27 - T30 - T40
- 910MQ/XZN 8-10 mm
- 910MQ/21 125 mm
- 910MQ/22 250 mm
- 910MQ/T
- 910MQ/55

2,7 kg



M108	1.280,00 €	1	024500108
MV108	69,00 €	1	024510108



- ⊕ 850MQ
- ⊕ 860TX/A10
- 920MQ/A 8 - 9 - 10 - 11 - 12 - 13 - 14 - 15 - 16 - 17 - 18 - 19 - 20 mm
- 920MQ/PE 5-6-8-10-12 mm
- 920MQ/21 125 mm
- 920MQ/22 250 mm
- 920MQ/55A
- 943MQ 6-7-8-10 mm

3,1 kg



M110	1.290,00 €	1	024500110
MV110	69,00 €	1	024510110



- ⊕ 861TX ● 1/4-T6+T15
- ⊕ 866TX ● 5/16-T20+T55
- 895/1 ○ 1/4x□1/4
- 895/6 ○ 5/16x□1/2
- ⊕ 900FTX □ 1/4-E4+E10
- ⊕ 920FTX □ 1/2-E12+E24
- ⊕ 920TX □ 1/2-T55L-T60-T70L

1,3 kg

14" 12"



M112	318,00 €	1	024500112
MV112	36,00 €	1	024510112



- ⊕ 666/20 40+200 Nm
- 920A 13 - 14 - 15 - 16 - 17 - 18 - 19 - 20 - 21 - 22 - 24 - 26 - 27 - 30 - 32 mm
- ⊕ 920FTX 12 - 14 - 16 - 18 - 20 - 22 - 24 mm
- 920PE 6 - 7 - 8 - 8L - 10 - 10L - 12 - 12L - 14 - 14L
- ⊕ 920TX T20 - T25 - T27 - T30 - T40 - T45 - T50 - T55 - T60 - T20L - T25L - T27L - T30L - T40L - T45L - T50L
- 920/21 125 mm
- 920/22 255 mm
- 920/25
- 920/42 305 mm
- ⊕ 920/55

7,8 kg

12"



M115	1.173,00 €	1	024500115
MV116	69,00 €	1	024510116



M120

75



- 920A 10-11-12-13-14-15-16-17-18-19-20-21
22-24-26-27-30-32 mm
- 920AN/125 125 mm
- 920AN/250 250 mm
- 920/25
- 920/42
- 920AL 10 - 12 - 13 - 14 - 15 - 16 - 17 - 18 - 19 -
22 - 24 - 27 - 30 - 32 mm
- 920FTX 10 - 12 - 14 - 16 - 18 - 20 - 22 - 24 mm
- 920/55
- 920PE 5 - 5L - 6 - 6L - 7 - 7L - 8 - 8L - 10 - 10L
- 12 - 12L - 14 - 14L
- 920TX T20-T25-T27-T30-T40-T45-T50-T55-T60
T20L-T25L-T27L-T30L-T40L-T45L-T50L

6,9 Kg

12"



M120	€ 1.305,00	1	024500120
MV120	€ 69,00	1	024510120

M121

46



- 920BP 5L - 6L - 8L - 10L - 5XL - 6XL - 8XL mm
- 920TX T20 - T25 - T27 - T30 - T40L - T45L
- T50L - T55L - T60L - T70L
- 920XZN 4 - 5 - 6 - 6L - 8 - 8L - 10 - 10L - 12 - 12L
- 14 - 14L - 16 - 18 mm
- 920ES 7 - 9 - 10 - 11 - 12L - 14L - 16L - 7XL -
9XL - 10XL - 11XL - 12XL - 14XL - 16XL
mm

920/36A

6,3 Kg

12"



M121	€ 1.230,00	1	024500121
MV121	€ 69,00	1	024510121

M125

68



- 910AL 8 - 9 - 10 - 11 - 12 - 13 - 14 - 15 - 16 - 17
- 19 - 21 - 22 mm
- 920PE 5-6-6L-7-8-8L-10-10L-12-12L mm
- 920FTX E12 - E14 - E16 - E18 - E20 - E22 - E24
- 920TX T20 - T25 - T27 - T30 - T30L - T40 - T40L
- T45 - T50 - T50L - T55 - T60 - T60L
- 920XZN 5 - 6 - 6L - 8 - 8L - 10 - 10L - 12L mm
- 920AL 10 - 12 - 13 - 14 - 15 - 16 - 17 - 18 - 19
- 21 - 22 - 23 - 24 - 27 - 30 - 32 mm

1692/5

7,9 kg

38" 12"



M125	€ 1.285,00	1	024500872
MV125	€ 69,00	1	024510872

M126

26



- 928A 19 - 21 - 22 - 24 - 26 - 27 - 28 - 30 - 32
- 34 - 35 - 36 - 38 - 41 - 46 mm
- 928ME 14-17-19-22 mm
- 928/15 □ 3/4 - ■ 1/2
- 928/16 □ 3/4 - ■ 1
- 928/21 200 mm
- 928/22 380 mm
- 928/25
- 928/42 450 mm
- 928/55

12,4 kg

34"



M126	€ 980,00	1	024500126
MV126	€ 69,00	1	024510126

M127

23



- 728 19 - 21 - 22 - 24 - 27 - 30 - 32 - 33 - 34
- 35 - 36 - 38 - 40 - 41 - 46
- 728FTX 20-22-24 mm
- 728/15 □ 3/4 - ■ 1/2
- 728/16 □ 3/4 - ■ 1
- 728/21 175 mm
- 728/22 250 mm
- 728/25

12,5 kg

34"



M127	€ 940,00	1	024500127
MV127	€ 69,00	1	024510127

M128

50



- 720 10 - 11 - 12 - 13 - 14 - 15 - 16 - 17 - 18
- 19 - 21 - 22 - 24 - 27 - 30 - 32 mm
- 720L 10 - 11 - 12 - 13 - 14 - 15 - 16 - 17 - 18
- 19 - 21 - 22 - 24 - 27 - 30 - 32 mm
- 720TX T30-T40-T45-T50-T55
- 720ME 5 - 6 - 8 - 10 - 12 - 14 - 17 - 19 mm
- 720LC 17-19-21 mm
- 720/21 125 mm
- 720/25

8,9 kg

12"



M128	€ 955,00	1	024500128
MV128	€ 69,00	1	024510128

M129

13



- 1032 180 mm
- 1034 170 mm
- 1036 175 mm
- 1038 175 mm
- 1048N 250 mm
- 1052 240 mm
- 1082BM 160 mm
- 1098 220 mm
- 1112 250 mm
- 1128BM
- 1150BM 180 mm
- 1166BM 160 mm
- 1168BM 160 mm

3,4 Kg



M129	€ 468,00	1	024500129
MV138	€ 69,00	1	024510138

M133

3



- 1082G 160 mm
- 1150G 180 mm
- 1166G 160 mm

650 g



M133	€ 86,50	1	024500133
MV133	€ 36,00	1	024510133

M134

3



- 1082GBM 160 mm
- 1150GBM 180 mm
- 1166GBM 160 mm

750 g



M134	€ 110,00	1	024500134
MV134	€ 36,00	1	024510134

M135



- 1082MQ 160 mm
- 1150MQ 180 mm
- 1166MQ 160 mm

750 g



M135	€ 184,00	1	024500135
MV135	€ 36,00	1	024510135

M136



- 1084BM 160 mm
- 1150BM 180 mm
- 1166BM 160 mm

750 g



M136	€ 125,00	1	024500136
MV131	€ 36,00	1	024510131

M137



- 1084 160 mm
- 1150 180 mm
- 1166 160 mm

650 g



M137	€ 102,00	1	024500137
MV132	€ 36,00	1	024510132

M145



- 1032 180 mm
- 1034 170 mm
- 1036 175 mm
- 1038 175 mm

640 g



M145	€ 137,50	1	024500145
MV145	€ 36,00	1	024510145

M153



- 1048N 250 mm
- 1052 240 mm

1 kg



M153	€ 105,00	1	024500153
MV154	€ 36,00	1	024510154

M161



- 1128MQ
- 1048MQ 250 mm
- 1082MQ 160 mm
- 1150MQ 180 mm
- 1162MQ 160 mm
- 1164MQ 160 mm
- 1272MQ PH0x60 - PH1x80 - PH2x100 - PH3x150 mm
- 1274MQ 2,5x75 - 3x100 - 4x100 - 5,5x125 mm
- 1777MQ/U

3,0 kg



M161	€ 545,00	1	024500161
MV161	€ 69,00	1	024510161

M162



- 1241 5,5x100 - 6,5x125 - 8x150 - 10x200 mm
- 1242 PH1x100 - PH2x100 - PH3x150 - PH4x200 mm

1,4 kg



M162	€ 151,00	1	024500162
MV162	€ 49,00	1	024510162



M166



860MIX/A31

- 1048N 250 mm
- 1082BM 160 mm
- 1150BM 180 mm
- 1162BM 160 mm
- 1290 3x75 - 4x100 - 5,5x100 - 6,5x150 - 8x150 mm
- 1290N 6,5x30 mm
- 1292 4,5x80 - 6x100 - 8x150 mm
- 1292N 6x30 mm
- 1297TX T20-T25-T27-T30

2,9 kg



M166	€ 482,00	1	024500879
MV880	€ 69,00	1	024510880

M170



- 1290 2,5x50 - 3x75 - 3,5x100 - 4x125 - 5,5x100 - 5,5x150 - 6,5x150 mm

500 g



M170	€ 82,00	1	024500170
MV170	€ 36,00	1	024510170

M172



- 1292 PH0x60 - PH0x100 - PH1x80 - PH1x120 - PH2x100 - PH2x150 mm

450 g



M172	€ 74,50	1	024500172
MV172	€ 36,00	1	024510172



M174



1297TX T8 - T10 - T15 - T20
- T25 - T30

450 g



M174	109,00 €	1	024500174
MV174	36,00 €	1	024510174

M180



1290 3x75
4x100
5,5x150
6,5x150 mm
1292 PH0x60
PH1x80
PH2x100 mm

500 g



M180	85,00 €	1	024500180
MV180	36,00 €	1	024510180

M195



1260 2,5x50 - 3x75 - 4x100 - 5,5x125 - 6,5x150
- 8x200 mm
1260N 4x30 mm
1262 PH0x60 - PH1x80 - PH2x100 - PH3x150
mm
1262N PH1x30 mm
1267TX T6 - T7 - T8 - T9 - T10 - T15 - T20 - T25
- T27 - T30 - T40 - T45
1253 3,5x100 mm

2,3 kg



M195	330,00 €	1	024500195
MV195	69,00 €	1	024510195

M201



1260 3x75 - 4x100 -
6,5x150 mm
1262 PH0x60 - PH1x80 -
PH2x100 mm

500 g



M201	84,50 €	1	024500201
MV201	36,00 €	1	024510201

M204



1267TX T8 - T10 - T15 - T20
- T25 - T30

450 g



M204	83,00 €	1	024500204
MV204	36,00 €	1	024510204

M208



1260 3x75
3,5x100
4x125
5,5x150
6,5x150 mm
1262 PH0x60
PH1x80
PH2x100 mm
1260N 4x30 mm
1262N PH1x30 mm

750 g



M208	95,50 €	1	024500208
MV208	49,00 €	1	024510208

M209



1260N 4x30 mm
1264 2,5x60 - 3x100 -
4x125 - 5x150 -
6,5x150 mm
1262 PH0x60 - PH1x80 -
PH2x100 mm
1262N PH1x30 mm

820 g



M209	94,00 €	1	024500209
MV208	49,00 €	1	024510208

M213

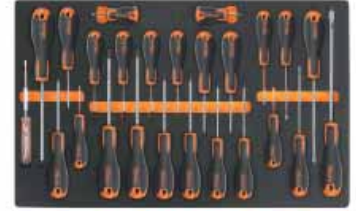

1201E 2,5x50 - 3x75 - 4x100 - 5,5x125 - 6,5x150
- 8x200 mm
1201EN 4x30 mm
1202E PH0x60 - PH1x80 - PH2x100 - PH3x150
mm
1202EN PH1x30 mm
1207E/TX T6 - T7 - T8 - T9 - T10 - T15 - T20 - T25
- T27 - T30 - T40 - T45
1253 3,5x100 mm

1,8 Kg



M213	222,50 €	1	024500213
MV210	69,00 €	1	024510210

M214



1201E 2,5x50 - 3x75 -
3,5x100
- 4x125 - 5,5x100 -
5,5x150 - 6,5x150 mm

500 g



M214	46,00 €	1	024500214
MV211	36,00 €	1	024510211

M216



1202E PH0x60 - PH1x80
- PH1x120 - PH2x100
- PH2x150 - PH3x150
mm

450 g



M216	50,00 €	1	024500216
MV212	36,00 €	1	024510212

M217

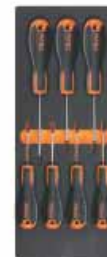

1207E/TX T6 - T7 - T8 - T9 - T10
- T15 - T20

500 g



M217	64,00 €	1	024500217
MV215	36,00 €	1	024510215



M218



- 1201E 3x75
4x100
5,5x150
6,5x150 mm
- ⊕ 1202E PH0x60
PH1x80
PH2x100 mm

500 g



M218	€ 48,50	1	024500218
MV220	€ 36,00	1	024510220

M219



- ⊕ 1202E 3x60 - 4,5x80 - 6x100 mm
- 1204E 3x75 - 4x100 - 5x150 - 6,5x150 mm

590 g



M219	€ 48,50	1	024500219
MV220	€ 36,00	1	024510220

M222



- ⊕ 1272MQ PH0x60 mm
- ⊕ 1272MQF PH1x80 - PH2x100 mm
- 1274MQF 3,5x100 - 4,5x100 - 5,5x125 - 6,5x150 mm

540 g



M222	€ 139,50	1	024500222
MV222	€ 36,00	1	024510222

M226



- 1274MQ 3x100
4x100
5,5x125
6,5x150 mm
- ⊕ 1272MQ PH0x60
PH1x80
PH2x100 mm

500 g



M226	€ 106,00	1	024500226
MV226	€ 36,00	1	024510226

M227



- 944BX 6-7-8-10-13 mm

420 g



M227	€ 129,50	1	024500227
MV227	€ 36,00	1	024510227

M230



- 30 Ø 2-3-4 mm
- 31 Ø 2-3-4-5-6-8 mm
- 32 Ø 4 mm
- 34 150 mm
- 35 200-250 mm
- 36 125 mm
- 1370 500 g
- 1390 Ø 35 mm
- 1692 3 m
- 1712TF
- 1719BMA/Q 200 mm
- ▲ 1719BMA/T 200 mm
- 1719BMA/P 200 mm
- ▶ 1719BMA/M 200 mm
- 1719BMA/R 200 mm
- 1737NX
- 1771 18 mm

3,2 Kg



M230	€ 425,00	1	024500230
MV230	€ 69,00	1	024510230



M231



- 31 2-3-4-5-6-8 mm
- 32 4 mm
- 34 125-150-175 mm
- 36 125 mm
- 1370 500-1000 g
- 1390 Ø 35 mm
- 1712TF 590 mm
- 1715 670 mm
- 1719BMA8/Q 200 mm
- ▲ 1719BMA8/T 200 mm
- 1719BMA8/P 200 mm
- ▶ 1719BMA8/M 200 mm
- 1719BMA8/R 200 mm
- 1737NX

4,7 kg



M231	€ 410,00	1	024500877
MV231	€ 69,00	1	024510877

M234



- 35 100-200 mm
- 1370 300 g
- 1390 Ø 35 mm

1,3 kg



M234	€ 107,00	1	024500234
MV232	€ 36,00	1	024510232

M236



- 1719BMA/Q 200 mm
- ▲ 1719BMA/T 200 mm
- 1719BMA/P 200 mm
- ▶ 1719BMA/M 200 mm
- 1719BMA/R 200 mm

870 g



M236	€ 106,00	1	024500236
MV236	€ 36,00	1	024510236

M237



35 100-200 mm
1370T 300 mm
1390N Ø 35 mm

1,3 kg



M237	€ 116,50	1	024500237
MV232	€ 36,00	1	024510232

M240



31BM Ø 2-3-4-5-6-8 mm
32 Ø 4 mm

850 g



M240	€ 139,00	1	024500240
MV240	€ 36,00	1	024510240

M264



1491 Ø 65+110 mm
1494 ■ 10 mm
1494E ○ 8 - 9 - 10 - 11 - 12 - 14 - 17 mm
1494Q ○ 8-9,5-12-13 mm
1494T △ 9,5
1494XZN ○ 16
1496C ■ 8x ■ 10 mm

2,1 kg



M264	€ 247,50	1	024500264
MV264	€ 36,00	1	024510264



M284



1128BMX
1130BMX
1719BMA...Q 200 mm
1719BMA...P 200 mm
1719BMA...M 200 mm
1719BMA...R 200 mm
1726BM 400 mm
1728BM (5)
1771BM 170 mm
1778V18 185 mm

2,4 Kg



M284	€ 250,00	1	024500284
MV284	€ 69,00	1	024510284

M292



111E 250 mm
1128BMX
1692/5 5 m
1771 170 mm

500 g



M292	€ 119,50	1	024500292
MV293	€ 36,00	1	024510293

M294



1692/5 5 m
1725CR 260 mm
1771 18 mm
1771RL

500 g



M294	€ 81,50	1	024500294
MV294	€ 36,00	1	024510294

M295



1650
1682 L=300 mm
1707
1708/20

450 g



M295	€ 121,00	1	024500295
MV295	€ 36,00	1	024510295

M305



1927B
720 12-13-14-15-16-17
18-19-21-22
24-27 mm
720/21

4,2 kg



M305	€ 420,00	1	024500305
MV305	€ 49,00	1	024510305

M310



1927CD
720 12-13-14-15-16-17
18-19-21-22
24-27 mm
720/21

4,0 kg



M310	€ 686,00	1	024500310
MV310	€ 49,00	1	024510310





M400

29



- 3932U
- 3935 120 mm
- 3937 170 mm
- 3952 13 - 14 - 15 - 16 - 17 - 18 - 19 mm
- 3961 3,2
- 3961 3,3
- 3961 3,5
- 3961U 3,2 - 4,0 mm
- 3969 200 mm (x2)
- 3969K3 113 mm
- 3973/1
- 3973/2
- 3973/3
- 3973/4
- 3984/1 Ø35 mm
- 3984/2 Ø22,8 mm
- 3984/3 Ø23,5 mm
- 3984/4 Ø23 mm
- 3991 222 mm
- 3992 234 mm

3,1 kg



M400	€ 632,00	1	024500400
MV400	€ 69,00	1	024510400

M401

7









- 3921 440 mm
- 3948
- 3953
- 3955 30x32 - 32x36 mm
- 3967 289 mm
- 3971



2,7 kg



M401	€ 382,00	1	024500401
MV401	€ 69,00	1	024510401

RSC22 RSC23 RSC23C C27S	277 mm  147 mm	277 mm  588 mm	543 559
			

C41S C41H	205 mm  418 mm		543
			

MC10

34



- 42 6-7-8-9-10-11-12
13-14-15-16-17
18-19-21-22 mm
- 96/SC9 1,5 - 2 - 2,5 - 3 - 4 - 5 - 6 - 8 - 10 mm
- ⚡ 1084BM 160 mm
- ≡ 1150G 180 mm
- 1166G 160 mm
- 1201E 3,5x100 - 5,5x150 - 6,5x150 mm
- ⊕ 1202E PH0x60 - PH1x80 - PH2x100 mm

3,5 kg



MC10	€ 402,00	1	027500011
MCV10	€ 49,00	1	027510010

MC12

26



- 42 6 - 7 - 8 - 9 - 10 - 11 - 12 - 13 - 14 - 15 - 16 - 17
- 18 - 19 - 21 - 22 mm
- 96/SC9 1,5 - 2 - 2,5 - 3 - 4 - 5 - 6 - 8 - 10 mm
- 1692/5 5 m

2,2 kg



MC12	€ 265,00	1	041500012
MCV11	€ 49,00	1	041510011

MC20

74



- 860MIX/A31
- 895/1
- 1048N 250 mm
- 1370 300 g
- 32 Ø 4 mm
- 36 Ø 4 mm
- 900 4 - 4,5 - 5 - 5,5 - 6 - 7 - 8 - 9 - 10 - 11 - 12 - 13 - 14 mm
- 900/21 150 mm
- 900/25
- 900BG/30C
- 900/42
- 900/55
- 920A 10 - 11 - 12 - 13 - 14 - 15 - 16 - 17 - 18 - 19 - 21 - 22 - 24
- 27 - 30 - 32 mm
- 920/25
- 920AN/125 125 mm
- 920/42
- 920/55

6 kg

12"

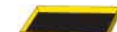

MC20	€ 628,00	1	027500020
MCV20	€ 49,00	1	027510021

MC21

24



- 920A 10 - 11 - 12 - 13 - 14 - 15 - 16 - 17 - 18 - 19 - 20
- 21 - 22 - 23 - 24 - 26 - 27 - 30 - 32 mm
- 920/25
- 920/42
- ⊕ 920/55
- 920AN 125-250 mm

4,3 kg



MC21	€ 352,00	1	041500021
MCV21	€ 49,00	1	041510021





C35

447 mm
1
600 mm

544÷546



MB12



- 42 6-7-8-9-10-11-12-13-14-15-16-17-18-19-20-21-22-24-27-30-32 mm
- 55 6x7-8x9-10x11-12x13-14x15-16x17-18x19-20x22 mm
- 1048N 250 mm

5,4 kg

€ 615,00 1 024504212
 MB12
 MBV13 188,00 1 024524213

MB37



- 920A 10-11-12-13-14-15-16-17-18-19-20-21-22-23-24-26-27-30-32 mm
- 920/21 125 mm
- 920/22 150 mm
- 920/25 125 mm
- 920/42 125 mm
- 920/55 125 mm
- 111E 250 mm
- 1052 240 mm
- 1084BM 160 mm
- 1150BM 180 mm
- 1166BM 160 mm
- 1032 180 mm
- 1034 170 mm
- 1036 175 mm
- 1038 175 mm
- 900 4-4,5-5-5,5-6-7-8-9-10-11-12-13-14 mm
- 900/20 50 mm
- 900/21 150 mm
- 900/25 150 mm
- 900BG/30 150 mm
- 900/55 150 mm
- 900/42 150 mm

7,0 kg

€ 940,00 1 024504237
 MB37
 MBV40 188,00 1 024524240

MB38



- 96T 2-2,5-3-4-5-6-7-8 mm
- 851SR 230 mm
- 860LP 0,5x3-0,6x4,5-0,8x5,5-1x5,5-1,2x6,5 mm
- 860PE 2-2,5-3-4-5-6-8-10 mm
- 860PH PH0 - PH1 - PH2 - PH3 - PH4
- 860PZ PZ1 - PZ2 - PZ3 - PZ4
- 860RTX T9 - T10 - T15 - T20 - T25 - T27 - T30 - T40
- 860TX T6 - T7 - T8 - T9 - T10 - T15 - T20 - T25 - T27 - T30 - T40
- 860/55 100 mm
- 882P 100 mm
- 892/0 100 mm
- 920A 10-11-12-13-14-15-16-17-18-19-20-21-22-23-24-26-27-30-32 mm
- 920/21 125 mm
- 920/22 255 mm
- 920/25 255 mm
- 920/42 255 mm
- 920/55 255 mm
- 1084BM 160 mm
- 1150BM 180 mm
- 1166BM 160 mm

5,9 kg

€ 814,00 1 024504238
 MB38
 MBV35 188,00 1 024524235



MB39



- 920A 10-11-12-13-14-15-16-17-18-19-20-21-22-23-24-26-27-30-32 mm
- 920/21 125 mm
- 920/22 255 mm
- 920/25 255 mm
- 920/42 255 mm
- 920/55 255 mm
- 920PE 5-6-8-10-12 mm
- 1032 180 mm
- 1034 170 mm
- 1036 175 mm
- 1038 175 mm
- 35 200 mm
- 1084BM 160 mm
- 1150BM 180 mm
- 1166BM 160 mm
- 1370 500 g
- 1390 35 mm

7,2 kg

€ 790,00 1 024504239
 MB39
 MBV36 188,00 1 024524236

MB44



- 1260 2,5x50-3x75-3,5x100-4x100-5,5x125-6,5x150-8x200 mm
- 1260N 4x30-6,5x30 mm
- 1262 PH0x60 - PH0x100 - PH1x80 - PH1x120 - PH2x100 - PH2x150 - PH3x150 mm
- 1262N PH1x30-PH2x30 mm
- 1253 125 mm
- 96BPC/SC9 951 2,5-3-4-5-6-8 mm

2,8 kg

€ 402,00 1 024504244
 MB44
 MBV44 188,00 1 024524244

MB45

29



- 1260 2,5x50 - 3x75 - 3,5x100 - 4x100 - 5,5x100 - 5x125 - 6,5x150 mm
- ⊕ 1262 PH0x60 - PH0x100 - PH1x80 - PH1x120 - PH2x100 - PH2x150 mm
- ⊖ 1267TX T8 - T10 - T15 - T20 - T25 - T30
- 1052 240 mm
- 96BPC/SC9

2,8 kg



MB45	€ 298,00	1	024504245
MBV45	€ 188,00	1	024524245

MB46

29



- 1260 3x75 - 4x100 - 5,5x125 - 6,5x150 mm
- ⊕ 1262 PH0x60 - PH1x80 - - PH2x100 mm
- ⊖ 1267TX T8 - T10 - T15 - T20 - T25 - T30
- 96BPC/SC9
- 96T 2-2,5-3-4-5-6
- 1052 240 mm

2,8 kg



MB46	€ 334,00	1	024504246
MBV46	€ 188,00	1	024524246

MB47

48



- 1260 3x75 - 4x100 - 5,5x125 - 6,5x150 mm
- ⊕ 1262 PH0x60 - PH1x80 - - PH2x100 mm
- 1260N 4x30 mm
- ⊕ 1262N PH1x30 mm
- 96T 2,5-3-4-5-6-8 mm
- 96BPC/SC9
- 920A 10 - 11 - 12 - 13 - 14 - 15 - 16 - 17 - 18 - 19 - 20 - 21 - 22 - 23 - 24 - 26 - 27 - 30 - 32 mm
- 920/21 125 mm
- 920/22 250 mm
- 920/25
- 920/42
- ⊗ 920/55

5,6 kg

12"



MB47	€ 644,00	1	024504247
MBV47	€ 188,00	1	024524247

MB56

15



- 1719BMA/Q 200 mm
- ▲ 1719BMA/T 200 mm
- 1719BMA/P 200 mm
- ▶ 1719BMA/M 200 mm
- 1719BMA/R 200 mm
- 1032 180 mm
- 1034 170 mm
- 1036 175 mm
- 1038 175 mm
- 1370T 300 g
- 1390N Ø 35 mm
- 35 200 mm
- 1692 5 mt
- 1725CR 260 mm
- 1771 18 mm

3,7 kg



MB56	€ 384,00	1	024504256
MBV56	€ 188,00	1	024524256

MB58

17



- 31 Ø 2-3-4-5-6 mm
- 32 Ø 4 mm
- 35 200 mm
- 1112 250 mm
- 1128BMX
- 1370 500 g
- 1390 Ø 45 mm
- 1719BMA...Q 200 mm
- ▲ 1719BMA...T 200 mm
- 1719BMA...P 200 mm
- ▶ 1719BMA...M 200 mm
- 1719BMA...R 200 mm
- 1726 440 mm

4,5 kg



MB58	€ 384,00	1	024504258
MBV55	€ 188,00	1	024524255

MB59

15



- 1719BMA...Q 200 mm
- ▲ 1719BMA...T 200 mm
- 1719BMA...P 200 mm
- ▶ 1719BMA...M 200 mm
- 1719BMA...R 200 mm
- 31 Ø 4-6 mm
- 32 Ø 4 mm
- 35 125-200 mm
- 1370 300 g
- 1390 Ø 35 mm
- 1692 5 mt
- 1725 420 mm
- 1833XS/2

3,4 kg



MB59	€ 320,00	1	024504259
MBV57	€ 188,00	1	024524257

MB65

16

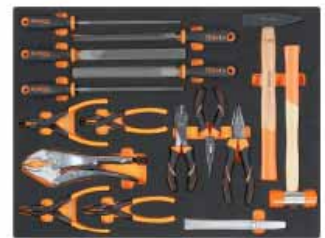

- 1719BMA...Q 200 mm
- 1719BMA...P 200 mm
- 1719BMA...T 200 mm
- 1719BMA...M 200 mm
- 1719BMA...R 200 mm
- 35 200 mm
- 1032 180 mm
- 1034 170 mm
- 1036 175 mm
- 1038 175 mm
- 1052 240 mm
- 1084BM 160 mm
- 1150BM 180 mm
- 1166BM 160 mm
- 1370 500 g
- 1390 Ø 35 mm

4,8 kg



MB65	€ 497,00	1	024504265
MBV61	€ 188,00	1	024524261



MB63

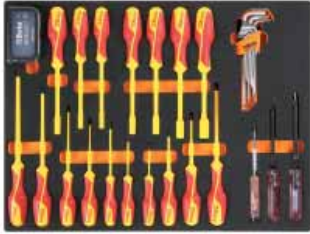

- 96BPC/SC9
- 1250 4x125 mm
- ⊕ 1251 PH1x125 mm
- 1253
- 943MQ 5,5-6-7-8-10-13 mm
- ⊕ 1272MQ PH0x60 - PH1x80 - PH2x100 - PH3x150 mm
- 1274MQ 2,5x75 - 3x100 - 4x100 - 5,5x125 - 6,5x150 - 8x175 mm
- 860LP 0,5x3 - 0,6x4 - 0,8x5,5 - 1,0x5,5 - 1,2x6,5 mm
- 860PE 2 - 2,5 - 3 - 4 - 5 - 6 - 8 - 10 mm
- ⊕ 860PH PH0 - PH1 - PH2 - PH3 - PH4
- ⊕ 860PZ PZ1 - PZ2 - PZ3 - PZ4
- ⊕ 860RTX T9 - T10 - T15 - T20 - T25 - T27 - T30 - T40
- 882MSR 50 ○ 1/4 ● 1/4
- 850MQ

3,2 kg

MB63	€ 515,00	1	024504263
MBV63	€ 188,00	1	024524263



MB64



- 55 6x7-8x9-10x11 - 12x13-14x15 - 16x17-18x19 - 20x22 mm
- 1048MQ 250 mm
- 1082MQ 140 mm
- 1128BSX
- 1132MQ 230 mm
- 1142MQ 160 mm
- 1150MQ 180 mm
- 1166MQ 160 mm
- 1168MQ 160 mm
- 110MQ 250 mm
- 1777MQ
- 993MQ
- 1602

4,1 kg

MB64	€ 920,00	1	024504264
MBV62	€ 188,00	1	024524262

C45PRO

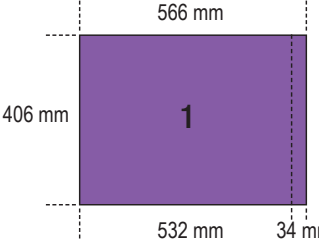

546



MM11



- 42 6 - 7 - 8 - 9 - 10 - 11 - 12 - 13 - 14 - 15 - 16 - 17 - 18 - 19 - 20 - 21 - 22 - 24 - 27 - 30 - 32 mm
- 96BPC/SC9 1,5 - 2 - 2,5 - 3 - 4 - 5 - 6 - 8 - 10 mm

4,5 kg

MM11	€ 420,00	1	024580011
MMV10	€ 69,00	1	024590010

MM26



- 42 6 - 7 - 8 - 9 - 10 - 11 - 12 - 13 - 14 - 15 - 16 - 17 - 18 - 19 - 21 - 22 - 24 - 27 mm
- 111E 250 mm
- 123Q1/4
- 123Q3/8
- 123Q1/2
- 142 8 - 9 - 10 - 11 - 12 - 13 - 14 - 15 - 16 - 17 - 18 - 19 mm

4,3 kg

MM26	€ 672,00	1	024580026
MMV26	€ 69,00	1	024590026



MM30

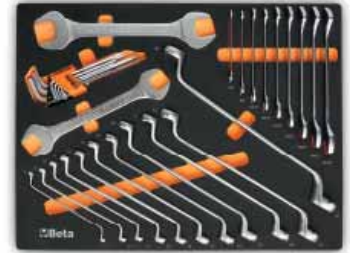

- 55 6x7-8x9-10x11-12x13-14x15-16x17 - 18x19-20x22-21x23-24x27-30x32 mm
- 90 6x7-8x9-10x11-12x13-14x15-16x17 - 18x19-20x22-21x23-24x27-30x32 mm
- 96BPC/SC9 1,5 - 2 - 2,5 - 3 - 4 - 5 - 6 - 8 - 10 mm

4,9 kg

MM30	€ 443,00	1	024580030
MMV30	€ 69,00	1	024590030

MM60



- 96T 2 - 2,5 - 3 - 4 - 5 - 6 - 7 - 8 - 10 mm
- 97BTX/SC8 T9-T10-T15-T20-T25-T27-T30-T40
- 944BX 5-6-7-8-10-13 mm

2,2 Kg

MM60	€ 413,00	1	024580060
MMV60	€ 69,00	1	024590060

MM63



- 952 7 - 8 - 10 - 12 - 13 - 14 - 17 - 19 mm

3,4 kg

MM63	€ 381,00	1	024580063
MMV63	€ 69,00	1	024590063

MM100

98



- 895/1
- 895/3
- 895/6
- 900 4 - 4,5 - 5 - 5,5 - 6 - 7 - 8 - 9 - 10 - 11 - 12 - 13 - 14 mm
- 900L 5 - 6 - 7 - 8 - 9 - 10 - 11 - 12 - 13 mm
- 900ME 3-4-5-6-7 mm
- 900LP 0,8x4 - 1x5,5 - 1,2x6,5 - 1,2x8 mm
- ⊕ 900PH PH1-PH2-PH3-PH4
- ⊕ 900TX T10 - T15 - T20 - T25 - T27 - T30 - T40
- 900/20 50 mm
- 900/20L 100 mm
- 900/21 150 mm
- 900/25
- 900BG/30
- 900/42
- ⊕ 900/55
- 920A 8-10-11-12-13-14-15-16-17-18-19-20-21-22-23-24-26-27-28-30-32 mm
- 920/15
- 920/25
- 920AN/125 125 mm
- 920AN/250 250 mm
- 920/42
- ⊕ 920/55
- 920/42 10 - 12 - 14 - 16 - 18 - 20 - 22 - 24 mm
- 920AL 10 - 12 - 13 - 14 - 15 - 16 - 17 - 18 - 19 - 21 - 22

6,7 Kg



MM100	1.225,00 €	1	024580100
MMV100	69,00 €	1	024590100



MM129

12

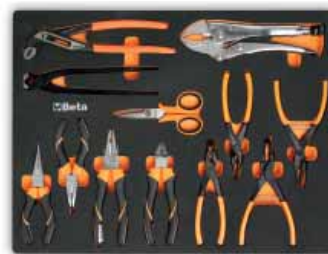

- 1032 180 mm
- 1034 170 mm
- 1036 175 mm
- 1038 175 mm
- 1048N 250 mm
- 1052 240 mm
- ⊕ 1082BM 160 mm
- 1098 220 mm
- 1128BM
- 1150BM 180 mm
- 1166BM 160 mm

2,9 Kg



MM129	438,00 €	1	024580129
MMV129	69,00 €	1	024590129

MM105

107



- 895/1 ○ 1/4-□ 1/4
- 895/3 ○ 1/4-□ 3/8
- 895/6 ○ 5/16-□ 1/2
- 900 4 - 4,5 - 5 - 5,5 - 6 - 7 - 8 - 9 - 10 - 11 - 12 - 13 - 14 mm
- 900L 5 - 6 - 7 - 8 - 9 - 10 - 11 - 12 - 13 mm
- 900ME 3-4-5-6-7 mm
- 900LP 0,8x4 - 1x5,5 - 1,2x6,5 - 1,2x8 mm
- ⊕ 900PH PH1-PH2-PH3-PH4
- ⊕ 900TX T10 - T15 - T20 - T25 - T27 - T30 - T40
- 900/16
- 900/... 50-100-150 mm
- 900/25
- 900BG/30 176 mm
- 900/42 115 mm
- ⊕ 900/55 125 mm
- 910A 6 - 7 - 8 - 9 - 10 - 11 - 12 - 13 - 14 - 15 - 16 - 17 - 18 - 19 - 20 - 21 - 22 mm
- 910/15 □ 3/8-■ 1/4
- 910/16 □ 3/8-■ 1/2
- 910/21 125 mm
- 910/22 250 mm
- 910/25
- 910/42 210 mm
- ⊕ 910/55 200 mm
- 920A 8 - 10 - 11 - 12 - 13 - 14 - 15 - 16 - 17 - 18 - 19 - 20 - 21 - 22 - 23 - 24 - 26 - 27 - 28 - 30 - 32 mm
- 920/15 □ 1/2-■ 3/8
- 920/25
- 920AN 125-250 mm
- 920/42 305 mm
- ⊕ 920/55 275 mm
- 956E 16 mm (5/8") - 17,8 (11/16") - 20,8 (13/16")

7,2 kg

14" 38" 12"



MM105	1.285,00 €	1	024580105
MMV105	69,00 €	1	024590105

MM210

25



- 1201E 2,5x50 - 3x75 - 4x100 - 5,5x125 - 6,5x150 - 8x200 mm
- 1201EN 4x30 mm
- ⊕ 1202E PH0x60 - PH1x80 - PH2x100 - PH3x150 mm
- ⊕ 1202EN PH1X30 mm
- ⊕ 1207E/TX T6 - T7 - T8 - T9 - T10 - T15 - T20 - T25 - T27 - T30 - T40 - T45
- 1253

2,1 kg



MM210	222,50 €	1	024580211
MMV210	69,00 €	1	024590210

MM230

25



30	Ø 2-3-4 mm
31	Ø 2-3-4-5-6-8 mm
32	Ø 4 mm
34	150 mm
35	200-250 mm
36	125 mm
1370	500 g
1390	Ø 35 mm
1692	3 m
1712TF	
1719BMA...Q	200 mm
1719BMA...T	200 mm
1719BMA...P	200 mm
1719BMA...M	200 mm
1719BMA...R	200 mm
1737NX	
1771	

3,2 Kg

MM230	446,00	1	024580230
MMV230	69,00	1	024590230

MM400

29



3932U	
3935	120 mm
3937	170 mm
3952	13 - 14 - 15 - 16 - 17 - 18 - 19 mm
<input type="checkbox"/> 3961 3,2	
<input type="checkbox"/> 3961 3,3	
<input type="checkbox"/> 3961 3,5	
<input type="checkbox"/> 3961U	3,2 - 4,0 mm
3969	200 mm (x2)
3969K3	113 mm
3973/1	
3973/2	
3973/3	
3973/4	
3984/1	
3984/2	
3984/3	
3984/4	
3991	222 mm
3992	234 mm

3,1 kg

MM400	632,00	1	024580400
MMV400	69,00	1	024590400

MM401

7



3921	440 mm
3948	
3953	
3955	30x32 mm - 32x36 mm
3967	289 mm
3971	

2,7 kg

MM401	382,00	1	024580401
MMV401	69,00	1	024590401

VPM0

termoformato morbido con vaschetta portaminuterie

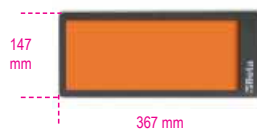

VPM0	28,50	1	088870350
------	-------	---	-----------

VPM3

termoformato morbido con 4 vaschette portaminuterie



VPM3	28,50	1	088870353
------	-------	---	-----------

VPM7

termoformato morbido con 3 vaschette portaminuterie

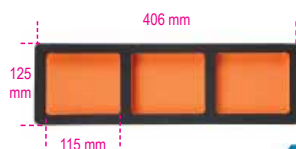

VPM7	30,00	1	088870356
------	-------	---	-----------

VPM8

termoformato morbido con vaschetta portaminuterie



VPM8	23,10	1	088870357
------	-------	---	-----------

VPM9

termoformato morbido con vaschetta portaminuterie



VPM9	22,40	1	088870358
------	-------	---	-----------

VPM7-C

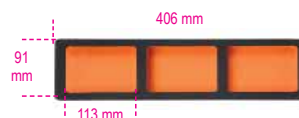

VPM7C	35,00	1	088870360
-------	-------	---	-----------



Termoformati rigidi serie T



Assortimenti di utensili in termoformato per tutti i modelli di cassettiere e per i carrelli.

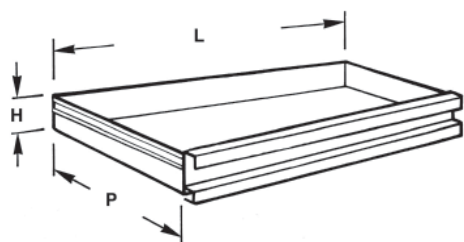

H mm	LxP mm
70	588x367

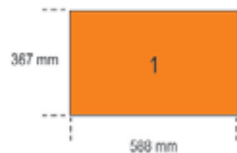
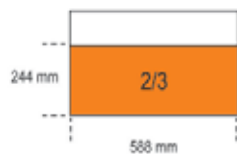
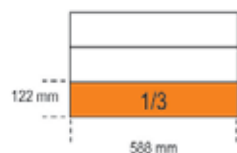
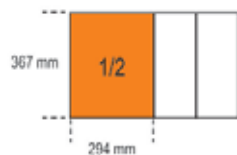
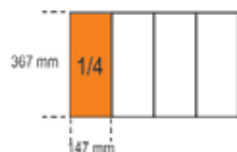

T01



42 6-7-8-10-11-12-13
14-16-17-18-19-21
22-24-27-30 mm

2,7 kg



T01	€ 275,00	1	024240001
TV10	€ 35,50	1	024000400

T05



42 6-7-8-9-10-11-12
13-14-15-16-17
18-19-20-21 mm

1,5 kg



T05	€ 209,00	1	024240005
TV15	€ 27,00	1	024000445

T06



42 22-24-27-30-32 mm

2,1 kg



T06	€ 149,50	1	024240006
TV16	€ 27,00	1	024000446

T18



42MP 6-7-8-9-10-11-12
13-14-15-16-17
18-19-20-21 mm

1,5 kg



T18	€ 299,00	1	024240018
TV15	€ 27,00	1	024000445

T19



42MP 22-24-27-30-32 mm

2,1 kg



T19	€ 197,00	1	024240019
TV16	€ 27,00	1	024000446

T22



42AS 5/16-3/8-7/16-1/2
9/16-5/8-11/16-3/4
○ 96AS/IG7 3/32-1/8-5/32-3/16
1/4-5/16-3/8

1 kg



T22	€ 161,00	1	024240022
TV20	€ 27,00	1	024000488

T23



42INOX 8-10-11-12-13-14-15-17-19 mm
○ 96BPINOX 2,5-3-4-5-6-8-10 mm

1 kg



T23	€ 279,00	1	024240023
TV23	€ 27,00	1	024249906

T31



31 Ø 2-3-4-5-6 mm
32 Ø 4 mm
55 6x7-8x9-10x11
12x13-14x15
16x17-18x19
20x22-21x23
24x26-27x29
30x32 mm
○ 96N/SC9 1,5±10 mm

3 kg



T31	€ 227,00	1	024240031
TV30	€ 35,50	1	024000401

T33



55
6x7-8x9-10x11
12x13-14x15
16x17-18x19
20x22 mm
○96/SC9 1,5+10 mm

1 kg



T33	€ 96,50	1	024240033
TV20	€ 27,00	1	024000488

T34



55MP
6x7-8x9-10x11
12x13-14x15
16x17-18x19
20x22 mm
○96/SC9 1,5+10 mm

1 kg



T34	€ 122,00	1	024240034
TV20	€ 27,00	1	024000488

T40



90
6x7-8x9-10x11
12x13-14x15
16x17-18x19 mm

810 g



T40	€ 106,00	1	024240040
TV40	€ 27,00	1	024000456

T41



90
20x22-21x23
24x26-25x28
27x29 mm

1,5 kg



T41	€ 157,50	1	024240041
TV41	€ 27,00	1	024000457

T45



142
8-9-10-11-12
13-14-15-16
17-18-19 mm

1,3 kg



T45	€ 316,00	1	024240045
TV45	€ 27,00	1	024000498

T46



142SN
8-9-10-11-12
13-14-15-16
17-18-19 mm

1,5 kg



T46	€ 377,00	1	024240046
TV46	€ 27,00	1	024000499

T48



○96BPC/SC9 1,5+10 mm
142C 8-9-10-11-12
13-14-15-16
17-18-19 mm

1,4 kg



T48	€ 269,00	1	024240048
TV47	€ 27,00	1	024000763

T50



○96T 2-2,5-3-3,5-4-4,5
5-6-7-8-10 mm

1,3 kg



T50	€ 178,50	1	024240050
TV50	€ 35,50	1	024000764

T52



○96T 2-2,5-3-4-5-6 mm

350 g



T52	€ 87,50	1	024240052
TV52	€ 27,00	1	024000765

T55



○97TTX T10-T15-T20
T25-T27-T30

330 g



T55	€ 101,00	1	024240055
TV55	€ 27,00	1	024000766

T59



111E 250 mm
920/40 1/2
951 2,5-3-4-5-6-8 mm
○953 4-5-6-8 mm
1370 300 - 500 g

4,7 kg



T59	€ 452,00	1	024240059
TV60	€ 53,00	1	024000420

T63



○952 7 - 8 - 10 - 12 - 13 - 14 - 17 - 19 mm

3,8 kg



T63	€ 342,00	1	024240063
TV63	€ 44,00	1	024000471

T64



- 952FTX E10-E12-E14
- 953TX T25 - T27 - T30 - T40 - T45

3,8 kg



T64	€ 419,00	1	024240064
TV63	€ 44,00	1	024000471

T65



- 953 3 - 3.5 - 4 - 5 - 6 - 7 - 8 - 10 mm

2,8 kg



T65	€ 326,00	1	024240065
TV63	€ 44,00	1	024000471

T68



- 951 2,5-3-4-5-6-8 mm

590 g



T68	€ 146,00	1	024240068
TV68	€ 27,00	1	024000470

T73



- 930 6x7 - 8x9 - 10x11 - 12x13 - 14x15 - 16x17 - 18x19 - 20x22 mm
- 940/1
- 940/2

1,3 kg



T73	€ 217,50	1	024240073
TV73	€ 27,00	1	024000418

T75



- 933 7-8-9-10-11-12-13 - 14-15-16-17-18-19 - 21-22-24 mm

4,2 kg



T75	€ 444,00	1	024240075
TV75	€ 53,00	1	024000422

T76



- 932 7-8-9-10-11-12-13 - 14-15-16-17-18-19 - 21-22-24 mm

4,2 kg



T76	€ 444,00	1	024240076
TV75	€ 53,00	1	024000422

T77



- 933 6-7-8-10-11-12-13 - 14-17-19 mm

1,4 kg



T77	€ 221,50	1	024240077
TV77	€ 27,00	1	024000474

T80



- 920A 10-11-12-13-14 - 15-16-17-18-19 - 20-21-22-23-24 - 26-27-30-32 mm
- 920ME 5-6-8-10-12 mm
- 920/21 125 mm
- 920/22 255 mm
- 920/25 305 mm
- 920/42 305 mm
- 920/55

4,1 kg

12"



T80	€ 419,00	1	024240080
TV80	€ 35,50	1	024000403

T81



- 920B 10-11-12-13-14 - 15-16-17-18-19 - 20-21-22-23-24 - 26-27-30-32 mm
- 920ME 5-6-8-10-12 mm
- 920/21 125 mm
- 920/22 255 mm
- 920/25 305 mm
- 920/42 305 mm
- 920/55

4,1 kg

12"



T81	€ 419,00	1	024240081
TV80	€ 35,50	1	024000403

T82



- 920A 10-11-12-13-14 - 15-16-17-18-19 - 20-21-22-23-24 - 26-27-30-32 mm
- 920ME 5-6-8-10-12 mm
- 920AN/125 125 mm
- 920AN/250 250 mm
- 920/25 305 mm
- 920/42 305 mm
- 920/55

4,1 kg

12"



T82	€ 433,00	1	024240082
TV80	€ 35,50	1	024000403

T83



- 920A 10-11-12-13-14 - 15-16-17-18-19 - 20-21-22-23-24 - 26-27-30-32 mm
- 920/21 125 mm
- 920/22 255 mm
- 920/25 305 mm
- 920/42 305 mm
- 920/55

3,6 kg

12"



T83	€ 326,00	1	024240083
TV83	€ 35,50	1	024000402



T85

81



- 861LP 0,5x3 - 0,6x4,5 - 0,8x5,5 - 1x5,5 - 1,2x6,5 - 1,2x8 - 1,6x8 mm
- 861PE 2 - 2,5 - 3 - 4 - 5 - 6 - 8 - 10 mm
- ⊕ 861PH PH0 - PH1 - PH2 - PH3
- ⊕ 861PZ PZ1 - PZ2 - PZ3
- ⊕ 861TX T6 - T7 - T8 - T9 - T10 - T15 - T20 - T25 - T27 - T30 - T40
- ⊕ 861RTX T9 - T10 - T15 - T20 - T25 - T27 - T30 - T40
- ⊕ 861TRW 1-2-3-4-5-6 mm
- ⊕ 861TQS 0 - 1 - 2 - 3 - 4 - 5 - 6 - 8 - 10 mm
- 861SP 4-6-8-10-12 mm
- 851SR 230 mm
- 900 4-4,5-5-5,5-6-7-8-9 - 10-11-12-13-14 mm
- 900/21 150 mm
- 900/25 41 mm
- 900BG/30 176 mm
- 900/42 115 mm
- ⊕ 900/55 125 mm
- 194 1/4x5/16

1,0 kg

14"

T85	€ 352,00	1	024240085
TV85	€ 35,50	1	024000747

T91

25



- 900 4-4,5-5-5,5-6 - 7-8-9-10-11 - 12-13-14 mm
- 900ME 2,5-3-4-5-6-8 mm
- 900/20 50 mm
- 900/21 150 mm
- 900/25
- 900BG/30
- 900/42 115 mm
- ⊕ 900/55

560 g

14"

T91	€ 224,50	1	024240091
TV90	€ 27,00	1	024000447

T92

22



- 910A 6-7-8-9-10-11-12-13 - 14-15-16-17-18-19 - 20-21-22 mm
- 910/21 125 mm
- 910/22 250 mm
- 910/25
- 910/42 210 mm
- ⊕ 910/55

1,5 kg

38"

T92	€ 257,00	1	024240092
TV92	€ 27,00	1	024000458

T99

16



- 920INOX-A 10-12-13-14-15-16-17 - 18-19-21-22-24-27 - 30-32mm
- ⊕ 920/55INOX



2,7 kg

12"

T99	€ 1.197,00	1	024240099
TV99	€ 27,00	1	024249908

T100

16



- 920A 10-12-13-14-15 - 16-17-18-19-21 - 22-24 mm
- 920/21 125 mm
- 920/25
- 920/42 305 mm
- ⊕ 920/55

2,1 kg

12"

T100	€ 233,00	1	024240100
TV100	€ 27,00	1	024000495

T101

16



- 920B 10-12-13-14-15 - 16-17-18-19-21 - 22-24 mm
- 920/21 125 mm
- 920/25
- 920/42 305 mm
- ⊕ 920/55

2,1 kg

12"

T101	€ 233,00	1	024240101
TV100	€ 27,00	1	024000495

T102

16



- 920AS 3/8-7/16-1/2 - 9/16-5/8-11/16 - 3/4-13/16-7/8 - 15/16-1-1.1/16
- 920/21 125 mm
- 920/25
- 920/42 305 mm
- ⊕ 920/55

2,1 kg

12"

T102	€ 254,00	1	024240102
TV100	€ 27,00	1	024000495

T103

17



- 900L 6-7-8-9-10-11-12 mm
- 920AL 13-14-16-17-18-19 - 21-22-24-27 mm

1,1 kg

14" 12"

T103	€ 301,00	1	024240103
TV103	€ 27,00	1	024000748

T105

11



- 928A 22-24-27-30-32-34 - 36-38-41-46-50 mm

4,9 kg

34"

T105	€ 306,00	1	024240105
TV105	€ 27,00	1	024000484

T106

4



- 928/21 200 mm
- 928/22 380 mm
- 928/42 450 mm
- 928/55

4,5 kg

34"

T106	€ 318,00	1	024240106
TV106	€ 27,00	1	024000485

T111

16



- 720 10-13-15-17-18-19-21 - 22-24-27-30-32 mm
- 720LC 17-19-21 mm
- 720/21 125 mm

2,7 kg

12"

T111	€ 258,00	1	024240111
TV111	€ 27,00	1	024000476

T112

32



- 861TX ● 1/4-T6+T15
- 866TX ● 5/16-T20+T55
- 895/1 ○ 1/4x□1/4
- 895/6 ○ 5/16x□1/2
- 900FTX □ 1/4-E4+E10
- 920FTX □ 1/2-E12+E24
- 920TX □ 1/2-T55L-T60-T70L

1,3 kg

14" 12"



T112	€ 305,00	1	024240112
TV112	€ 27,00	1	024000480

T113

12



- 920PE 5L-6L-7L-8L-10L
- 920TX T40L-T45L
T55L-T70L
- 920XZN M6L-M8L-M12L

1,5 kg

12"



T113	€ 268,00	1	024240113
TV113	€ 27,00	1	024000489

T122

1



666/20 40 - 200 Nm

1,2 kg

12"



T122	€ 297,00	1	024240122
TV122	€ 27,00	1	024000768

T123

3



- 1082G 160 mm
- 1150G 180 mm
- 1166G 160 mm

550 g



T123	€ 81,50	1	024240123
TV135	€ 27,00	1	024000762

T124

3



- 1082GBM 160 mm
- 1150GBM 180 mm
- 1166GBM 160 mm

640 g



T124	€ 104,00	1	024240124
TV135	€ 27,00	1	024000762

T135

3



- 1082MQ 160 mm
- 1150MQ 180 mm
- 1166MQ 160 mm

△ 1000 V

750 g



T135	€ 172,50	1	024240135
TV135	€ 27,00	1	024000762

T136

2



- 1048MQ 250 mm
- 1777MQ/U

△ 1000 V

700 g



T136	€ 123,00	1	024240136
TV136	€ 27,00	1	024000438

T137

3



- 1084BM 160 mm
- 1150BM 180 mm
- 1166BM 160 mm

750 g



T137	€ 116,50	1	024240137
TV130	€ 27,00	1	024000451

T138

3



- 1084 160 mm
- 1150 180 mm
- 1166 160 mm

650 g



T138	€ 96,50	1	024240138
TV130	€ 27,00	1	024000451

T140

8



- 1032 140x0,9 - 180 mm
- 1034 170 mm
- 1036 140x1,3 - 175 mm
- 1038 175 mm
- 1084 160 mm
- 1128BM

1,1 kg



T140	€ 237,50	1	024240140
TV140	€ 35,50	1	024000405

T144

4



- 1048N 250 mm
- 1052 240 mm
- 1112 250 mm
- 1150 180 mm

1,8 kg



T144	€ 142,50	1	024240144
TV143	€ 35,50	1	024000409

T145

4



- 1032 180 mm
- 1034 170 mm
- 1036 175 mm
- 1038 175 mm

640 g



T145	€ 131,00	1	024240145
TV145	€ 27,00	1	024000448

T146



- 1032 140x0,9 mm
- 1032 225 mm
- 1036 140x1,3 mm
- 1036 225 mm

700 g



T146	€ 137,50	1	024240146
TV146	€ 27,00	1	024000449

T151



- 1047 240 mm
- 1057A 240 mm

1,3 kg



T151	€ 118,00	1	024240151
TV150	€ 27,00	1	024000462

T153



- 1048N 250 mm
- 1052 240 mm

1,1 kg



T153	€ 78,00	1	024240153
TV150	€ 27,00	1	024000462

T156



- ◄ 1082 160 mm
- ▬ 1150 180 mm
- 1048N 250 mm

1 kg



T156	€ 100,50	1	024240156
TV148	€ 27,00	1	024000500

T157



- ◄ 1082BM 160 mm
- ▬ 1150BM 180 mm
- 1048BM 250 mm

1,1 kg



T157	€ 129,50	1	024240157
TV148	€ 27,00	1	024000500

T160



- 1290 3x75
3x100
4x100
4x150
5,5x100
5,5x150
6,5x150
8x150
10x200 mm
- 1290N 4x30
6,5x30 mm

1,3 kg



T160	€ 142,50	1	024240160
TV160	€ 35,50	1	024000706

T161



- 1292 PH0x60
PH0x100
PH1x80
PH1x120
PH2x100
PH2x150
PH3x150 mm
- 1292N PH1x30
PH2x30 mm

1 kg



T161	€ 112,00	1	024240161
TV161	€ 35,50	1	024000707

T164



- 952 8-10-13-17-19 mm
- 959 16 mm (5/8") - 20,8 mm (13/16")
- 1260 3x75 - 4x100 - 5,5x100 - 6,5x150 - 10x200 mm
- 1262 PH0x60 - PH1x80 - PH2x100 - PH3x150 mm

5 kg

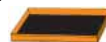

T164	€ 480,00	1	024240164
TV61	€ 53,00	1	024000721

T167



- 1260 3x75
3x100
4x100
4x150
5,5x100
5,5x150
6,5x100
8x150
10x200 mm
- 1260N 4x30
6,5x30 mm

1,3 kg



T167	€ 115,00	1	024240167
TV160	€ 35,50	1	024000706

T168



- 1262 PH0x60
PH0x100
PH1x80
PH1x120
PH2x100
PH2x150
PH3x150 mm
- 1262N PH1x30
PH2x30 mm

1 kg



T168	€ 91,50	1	024240168
TV161	€ 35,50	1	024000707

T170



- 1290 2,5x50
3x75
3,5x100
4x125
5,5x100
5,5x150
6,5x150 mm

450 g



T170	€ 77,50	1	024240170
TV170	€ 27,00	1	024000741

T171



- 1290 8x150
8x200
10x200 mm
- 1290N 4x30
6,5x30 mm

750 g



T171	€ 85,50	1	024240171
TV171	€ 27,00	1	024000742

T172

Betamax



1292

PH0x60
PH0x100
PH1x80
PH1x120
PH2x100
PH2x150 mm

450 g



T172	€ 70,50	1	024240172
TV172	€ 27,00	1	024000743

T173

Betamax



1292

PH3x150
PH4x200 mm

1292N

PH1x30
PH2x30 mm

560 g



T173	€ 69,00	1	024240173
TV173	€ 27,00	1	024000744

T175

Betamax



1297TX

T6-T7-T8-T9
T10-T15-T20

410 g



T175	€ 110,00	1	024240175
TV175	€ 27,00	1	024000760

T176

Betamax



1297TX

T25-T27-T30
T40-T45

640 g



T176	€ 102,00	1	024240176
TV176	€ 27,00	1	024000761

T177

Betamax



1298RTX

T9-T10-T15
T20-T25-T27
T30-T40

680 g



T177	€ 154,00	1	024240177
TV177	€ 27,00	1	024000759

T180

Betamax



1290

3x75
4x100
5,5x150
6,5x150 mm

1292

PH0x60
PH1x80
PH2x100 mm

480 g



T180	€ 80,50	1	024240180
TV180	€ 27,00	1	024000701

T183

Betamax



1292L PH1x400-PH2x400 mm

1294L 3x300-4x400-5x400 mm

580 g



T183	€ 109,00	1	024240183
TV183	€ 27,00	1	024000497

T198

Betamax



1260

3x75
4x100
5,5x150
6,5x150 mm

1269PZ

PZ0 - PZ1 - PZ2

490 g



T198	€ 68,50	1	024240198
TV180	€ 27,00	1	024000701

T199

Betamax



1260

2,5x50
3x75
3,5x100
4x125
5,5x100
5,5x150
6,5x150 mm

490 g



T199	€ 61,50	1	024240199
TV170	€ 27,00	1	024000741

T201

Betamax



1260

8x200
10x150
10x200 mm

1260N

4x30
6,5x30 mm

680 g



T201	€ 67,00	1	024240201
TV171	€ 27,00	1	024000742

T202

Betamax



1262

PH0x60
PH0x100
PH1x80
PH1x120
PH2x100
PH2x150 mm

490 g



T202	€ 56,50	1	024240202
TV172	€ 27,00	1	024000743

T204

Betamax



1262

PH3x150
PH4x200 mm

1262N

PH1x30
PH2x30 mm

610 g



T204	€ 55,50	1	024240204
TV173	€ 27,00	1	024000744

T205



1267TX T6-T7-T8-T9
T10-T15-T20

460 g



T205	80,50 €	1	024240205
TV175	27,00 €	1	024000760

T206



1267TX T25-T27-T30
T40-T45

710 g



T206	83,00 €	1	024240206
TV176	27,00 €	1	024000761

T207



1268RTX T9-T10-T15
T20-T25-T27-T30

760 g



T207	99,00 €	1	024240207
TV207	27,00 €	1	024000758

T208



1260 3x75
4x100
5,5x150
6,5x150 mm
1262 PH0x60
PH1x80
PH2x100 mm

530 g



T208	65,00 €	1	024240208
TV180	27,00 €	1	024000701

T209



1262L PH1x400-PH2x400 mm
1264L 3x300 - 4x400 - 5x400 mm

580 g



T209	81,00 €	1	024240209
TV183	27,00 €	1	024000497

T211



1201E 2,5x50
3x75
3,5x100
4x125
5,5x100
5,5x150
6,5x150 mm

490 g



T211	43,50 €	1	024240211
TV170	27,00 €	1	024000741

T213



1202E PH0x60
PH1x80
PH1x120
PH2x100
PH2x150
PH3x150 mm

490 g



T213	47,50 €	1	024240213
TV212	27,00 €	1	024000440

T216



1207E/TX T6-T7-T8-T9
T10-T15-T20

410 g



T216	60,50 €	1	024240216
TV175	27,00 €	1	024000760

T221



1201E 3x75
4x100
5,5x150
6,5x150 mm
1202E PH0x60
PH1x80
PH2x100 mm

530 g



T221	46,00 €	1	024240221
TV180	27,00 €	1	024000701

T226



1274MQ 3x100
4x100
5,5x125
6,5x150 mm
1272MQ PH0x60
PH1x80
PH2x100 mm

1000 V

460 g



T226	100,00 €	1	024240226
TV180	27,00 €	1	024000701

T227



944BX 5-6-7-8-10-13 mm

490 g



T227	140,50 €	1	024240227
TV227	27,00 €	1	024000705

T228



1290INOX 3x75 - 4x100 -
5,5x150 - 6,5x150 mm
1292INOX PH0x60 - PH1x80 -
PH2x100 mm

Beta
INOX
STAINLESSSTEEL

480 g



T228	90,00 €	1	024240228
TV180	27,00 €	1	024000701

T231



- 1370 400 g
- 1390 Ø 35 mm
- ▲ 1719BMA/T 200 mm
- 1719BMA/P 200 mm
- ▷ 1719BMA/M 200 mm

1,7 kg



T231	€ 123,00	1	024240231
TV230	€ 35,50	1	024000411

T233



- 35 100-200 mm
- 1370F 32 mm
- 1390 Ø 35 mm

1,3 kg



T233	€ 112,50	1	024240233
TV232	€ 27,00	1	024000452

T234



- 35 100-200 mm
- 1370 300 g
- 1390 Ø 35 mm

1,3 kg



T234	€ 101,00	1	024240234
TV232	€ 27,00	1	024000452

T236



- 1719BMA/Q 200 mm
- ▲ 1719BMA/T 200 mm
- 1719BMA/P 200 mm
- ▷ 1719BMA/M 200 mm
- 1719BMA/R 200 mm

870 g



T236	€ 100,00	1	024240236
TV235	€ 27,00	1	024000453

T239



- 31BM Ø 2-3-4-5-6-8 mm
- 32 Ø 4 mm

850 g



T239	€ 132,50	1	024240239
TV239	€ 27,00	1	024000439

T241



- 1500N/1
- 1500N/3
- 1516/1

4,2 kg



T241	€ 310,00	1	024240241
TV241	€ 35,50	1	024000414

T259



- 96BP 2,5-3-4-5
6-8-10 mm
- 96N 12 mm
- 860MIX/A31
-
- +
- +
- +
- 895/1

950 g



T259	€ 155,00	1	024240259
TV263	€ 27,00	1	024000492

T264



- 1491 Ø 65-110 mm
- 1494 10 mm
- 1494E ○ 8-9-10-11-12-14-17 mm
- 1494Q ○ 8-9,5-12-13 mm
- △ 1494T △ 9,5
- 1494XZN ○ 16
- 1496C ■ 8x ■ 10 mm

2,1 kg



T264	€ 232,50	1	024240264
TV264	€ 27,00	1	024000466

T270



- 430 M3 - 4 - 5 - 6 - 7 - 8 - 9
10 - 12 - 14 - 16 - 18 - 20
- 433 M6x0,75 - M8x1 - M10x1,25
M12x1,5 - M14x1,5
M16x1,5 - M18x1,5
- 440 M3 - 4 - 5 - 6 - 7 - 8 - 9
- 440A M10 - 12 - 14 - 16 - 18 - 20
- 441 M6x0,75 - M8x1,0
- 441A M10x1,25 - M12x1,5
M14x1,5 - M16x1,5
M18x1,5

4,3 kg



T270	€ 536,00	1	024240270
TV270	€ 35,50	1	024000481

T273



- 435/1,5 M3=M12
- 435/3 M5=M21
- 436/1 □ 2,0+5,0 mm (M3=M8)
- 436/2 □ 4,6+8 mm (M5=M12)
- 444/1 Ø 25,4 mm
- 444/2 Ø 38,1 mm
- 1707 W 62+4x1"

2,1 kg



T273	€ 244,00	1	024240273
TV272	€ 35,50	1	024000482

T281



- 1741B 250 mm
- 1741RV2,9K 2,9x6 mm (100)
- 1741RV3,2K 3,2x8 mm (100)
- 1741RV3,8K 3,8x10 mm (100)
- 1741RV4K 4x12 mm (100)

1,4 kg



T281	€ 76,00	1	024240281
TV280	€ 27,00	1	024000478

T279



- 1112 250 mm
- 1128BM
- 1726 400 mm
- 1728BM (x5)
- 1751N 200 cc

1,5 kg



T279	€ 132,00	1	024240279
TV285	€ 44,00	1	024000487

T284



- 1128BMX
- 1130BMX
- 1719BMA...Q 200 mm
- ▲ 1719BMA...T 200 mm
- 1719BMA...P 200 mm
- ▶ 1719BMA...M 200 mm
- 1719BMA...R 200 mm
- 1726BM 400 mm
- 1728BM
- 1771BM 170 mm
- 1778V18 185 mm

3,3 kg



T284	€ 262,00	1	024240284
TV286	€ 53,00	1	024249904

T291



- 1479RB/1
- 1479RB/2
- 1479RB/3

600 g



T291	€ 105,00	1	024240291
TV291	€ 27,00	1	024000472

T294



- 1692 5 m
- 1725CR
- 1771RL
- 1771

590 g

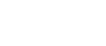

T294	€ 72,50	1	024240294
TV294	€ 27,00	1	024000491

T297



- 1651DGTB
- 1682
- 1691BM

490 g



T297	€ 145,50	1	024240297
TV296	€ 27,00	1	024000749



VP1 - VP2

termoformati portaminuterie
in materiale plastico per tutti i modelli
di cassettiere: RSC22, RSC23, RSC23C

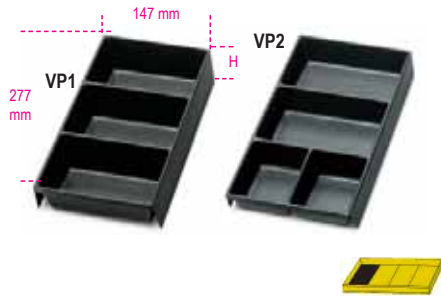

	H mm	€	1	088880351
VP1	50	15,30	1	088880351
VP2	35	15,30	1	088880352

VP3 - VP4

termoformati portaminuterie in materiale
plastico per tutti i modelli di cassettiere
e per i carrelli

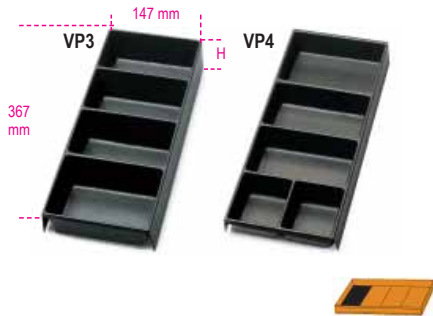

	H mm	€	1	088880353
VP3	50	16,10	1	088880353
VP4	35	16,10	1	088880354

VP5 termoformato



VP5		€ 18,20	1	088880355
-----	--	---------	---	-----------

VP6 termoformato



VP6		€ 18,50	1	088880359
-----	--	---------	---	-----------

VP-3SC

termoformati portaminuterie in materiale
plastico per cassetiera C38 +C04TSS-7

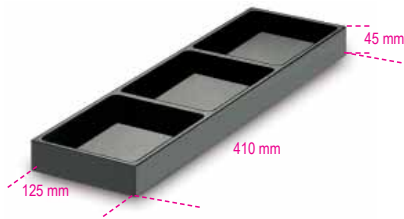

VP-3SC	H mm	€ 19,40	1	088880356
	45			

VP-LS

termoformati portaminuterie in materiale
plastico per cassetiera C38 +C04TSS-7



VP-LS	H mm	€ 13,20	1	088880357
	45			

VP-LD

termoformati portaminuterie in materiale
plastico per cassetiera C38



VP-LD	H mm	€ 12,70	1	088880358
	45			

8889P1

separatori paralleli per RSC22, RSC23,
RSC23C e C27S
cassetto 588x277 mm



	h	€	1	088890005
8889P1/5	50 mm	51,00	1	088890005
8889P1/7	70 mm	52,50	1	088890007

8889C1

separatori incrociati per RSC22, RSC23,
RSC23C e C27S
cassetto 588x277 mm



	h	€	1	088890015
8889C1/5	50 mm	68,50	1	088890015
8889C1/7	70 mm	70,00	1	088890017

8889P2

separatori paralleli per cassetto standard
588x367 mm



8889P2/7	h	€ 61,50	1	088890107
	70 mm			

8889C2

separatori incrociati per cassetto standard
588x367 mm



8889C2/7	h	€ 79,00	1	088890117
	70 mm			

8889P3

separatori paralleli per RSC24AXL

cassetto 882x367 mm



8889P3/7	h	€ 98,50	1	088890207
	70 mm			

8889C3

separatori incrociati per RSC24AXL

per cassetto 882x367 mm



8889C3/7	h	€ 120,00	1	088890217
	70 mm			

8889P4

separatori paralleli per trolley C41

cassetto 418x205 mm



8889P4/7	h	€ 41,50	1	088890307
	70 mm			

8889I4

separatori incrociati per trolley C41

cassetto 418x205 mm



8889C4/7	h	€ 50,00	1	088890317
	70 mm			

8889PS

separatori paralleli per C38 - C45PRO M4/M5/
M7/M8

cassetto lato sinistro 570x410 mm



8889PS/7 70 mm € 73,00 1 088890407

8889CS

separatori incrociati per C38 - C45PRO M4/
M5/M7/M8

cassetto lato sinistro 570x410 mm



8889CS/7 70 mm € 89,00 1 088890417

8889PD

separatori paralleli per C38

cassetto lato destro 313x410 mm



8889PD/7 70 mm € 39,00 1 088890427

8889CD

separatori incrociati per C38

cassetto lato destro 313x410 mm



8889CD/7 70 mm € 53,50 1 088890437

8889C6

separatori incrociati per C35

cassetto 600x447 mm

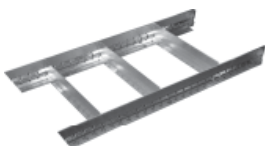

8889C6/7,5 75 mm € 38,00 1 088890475
8889C6/10 100 mm € 37,50 1 088890480
8889C6/15 150 mm € 46,50 1 088890485
8889C6/20 200 mm € 72,50 1 088890490

SB

guide portabussole



	L mm	€	10	10
SB1	210	3,90	10	088880201
SB2	280	4,30	10	088880202
SB3	360	4,55	10	088880203

PM 1/2-Q5

guida magnetica portabussole



PM 1/2-Q5 € 47,50 1 088880233

MB

molle per guide SB



	□	€	50	50
MB0	1/4	1,16	50	088880210
MB1	3/8	1,16	50	088880211
MB2	1/2	1,16	50	088880212

KIT/GPS

Kit ganci GPS con viti VE1

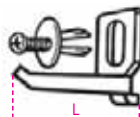

KIT/GPS-40 mm	€ 2,24	50	088880119
KIT/GPS-90 mm	€ 3,25	50	088880117

VE1

Viti ad espansione



VE1 € 0,79 20 088880120

GM

ganci a molla con vite ad espansione VE1



∅ mm	€	5	5
6,5	7,15	5	088880250
9,5	7,45	5	088880251
13	7,45	5	088880252
16	8,80	5	088880253
19	9,15	5	088880254
25	8,65	5	088880255

S55/8

supporti per 8 chiavi a forchetta, in lamiera

• fornito completo di 3 viti ad espansione VE1

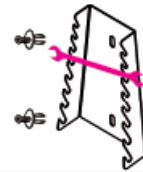

S55/8 € 24,50 1 088880420
55/S8
55AS/8
55MP/S8

S55/12

supporti per 12 chiavi a forchetta, in lamiera

• fornito completo di 3 viti ad espansione VE1

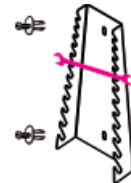

S55/12 € 30,00 1 088880421
55/S12
55/S12X
55AS/12
55MP/S12

ST2P

supporti portapinzine, in lamiera

• fornito completo di 3 viti ad espansione VE1

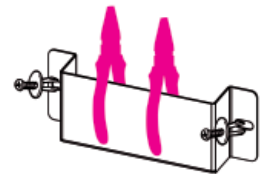

ST2P € 27,00 1 088880422

TSPP

supporti portautensili, in materiale plastico

• fornito completo di 3 viti ad espansione VE1

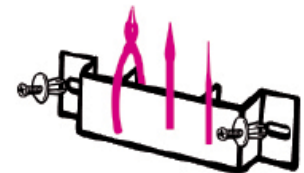

TSPP € 6,05 1 088880402

S952/10

supporti per 10 chiavi a T, in lamiera

• fornito completo di 4 viti ad espansione VE1

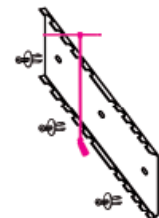

S952/10 € 32,00 1 088880423

S1719BM

supporti per 5 lime, in lamiera

• fornito completo di 3 viti ad espansione VE1



S1719BM € 18,50 1 088880404

1719BMA: Q-T-P-M-R
1719BMD: Q-T-P-M-R
1719BMX: Q-T-P-M-R

SGN

supporti per 2 giravite nano, in lamiera

• fornito completo di 3 viti ad espansione VE1



SGN € 9,35 1 088880405

1290N-1292N-1299N/PZ
1260N-1262N-1269N/PZ
1201EN-1202EN-1209EN/PZ

CB/2

termoformato rigido vuoto per bussole e accessori da 1/2"

• solo per C54S

12"

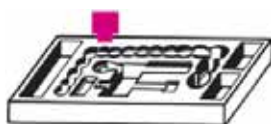

CB/2 € 28,50 1 088880411

920A/920B
10÷24+26-27
28-30-32 mm
920/21-920/22-920/25-
920/42-920/55

S42/17

supporti per 17 chiavi combinate, in lamiera

• fornito completo di 3 viti ad espansione VE1

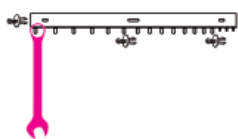

S42/17 € 31,50 1 088880428

42/S17
42MP/S17
42/S17X
42AS/17
142/S17

S951/6

supporti per 6 chiavi a T maschio, in lamiera

• fornito completo di 3 viti ad espansione VE1

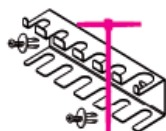

S951/6 € 20,90 1 088880429

951/S6
951AS/S6X
951TX/S6

SPG11 - S1203/8

supporti per giravite, in lamiera

• fornito completo di 3 viti ad espansione VE1



SPG11 € 21,70 1 088880910

n.8 Ø = 7 mm
n.2 Ø = 10 mm
n.1 Ø = 12 mm

S1203/8 € 23,10 1 088880430

1203E/S8
1263/D8
1293/S8

S96T/8

supporti per 8 chiavi maschio esagonali con impugnatura, in lamiera

• fornito completo di 3 viti ad espansione VE1

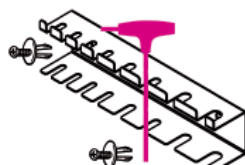

S96T/8 € 23,10 1 088880431

96T/AS8
96T/S8
97TTX/S8

96T/SPV

supporti per 11 chiavi maschio esagonali con impugnatura, in lamiera

• fornito completo di 3 viti ad espansione VE1

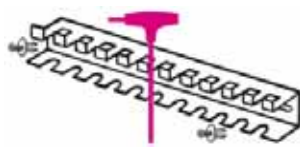

96T/SPV € 45,00 1 000960958

96T/S11
97TTX/S11



Beta



Beta CHEMICALS

Prodotti anaerobici

I prodotti anaerobici garantiscono il completo riempimento delle piccole irregolarità superficiali del metallo in modo da garantire la distribuzione delle sollecitazioni meccaniche su tutta la superficie di collegamento. Si consolidano in totale assenza di ossigeno e sigillano completamente il giunto o la filettatura rispetto ad acqua, gas, oli, carburanti e fluidi industriali. Sono disponibili in tre classi di resistenza: forte (H), media (M) e bassa (L) e in differenti confezionamenti per soddisfare le differenti esigenze.

Sigillante siliconico

I sigillanti siliconici permettono di effettuare sigillature elastiche permanenti, evitando l'ingresso nel giunto di sostanze di piccole dimensioni (detriti, polvere...) e sostituendo le guarnizioni preformate. Grazie alla loro capacità elastica riescono ad assorbire il movimento senza avere dilatazioni al proprio interno o rotture. I sigillanti siliconi polimerizzano reagendo all'umidità atmosferica e formano una guarnizione elastica e resistente. L'erogazione del prodotto viene facilitata grazie ad un pratico dosatore (pressure pack) che semplifica il lavoro. È utilizzabile anche con una sola mano e garantisce una distribuzione precisa ed uniforme del prodotto.

Colla istantanea

Adesivo a base di cianocrilato etilico, per giunzioni strutturali di vari materiali.

Aerosol

Ampia gamma di prodotti in bombolette spray concepiti per sbloccare, ingrassare, lubrificare, pulire, zincare e igienizzare.

Le bombolette sono in acciaio, completamente riciclabili.

Liquidi

Nascono per rimuovere incrostazioni e ruggine da pezzi meccanici e oggetti metallici. Ideali per l'impiego con le vasche di lavaggio a ultrasuoni 1895.

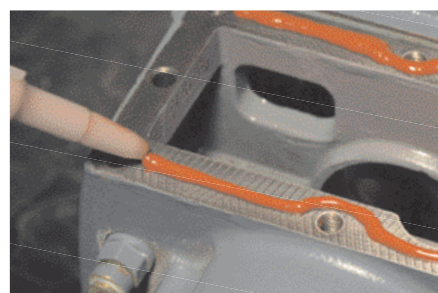

ATTENZIONE

Paesi in cui è possibile distribuire i prodotti della linea Beta Chemicals: Austria, Andorra, Belgio, Emirati Arabi Uniti, Francia, Italia, Nuova Caledonia, Paesi Bassi, Polonia, Portogallo, Principato di Monaco, Regno Unito, Repubblica Ceca, Repubblica d'Irlanda, Repubblica Dominicana, Repubblica Popolare Cinese, Reunion, San Marino, Slovacchia, Slovenia, Spagna, Svizzera, Ungheria

9803H

frenafiletti - forte resistenza

Ideale per bloccaggio permanente di parti che non devono essere smontate.

Per l'applicazione su superfici metalliche passivate come ottone, alluminio e acciaio inox.

Non consente lo smontaggio con utensili manuali.



Temperatura di impiego (°C)	-50/+150
Gioco diametrale (mm)	0,25
Velocità di reazione	10/15
blocco alla mano (minuti)	
Indurimento funzionale (ore)	3-6
Viscosità (mPa.s) 25°C	800/1200
Coppia di svitamento	35-45 Nm
INIZIALE (ISO-10964)	
Coppia di svitamento	30-40 Nm
RESIDUA (ISO-10964)	

ml	€	🚚	🏠
20	11,90	12	098030002
50	18,10	4	098030005
250	46,00	4	098030025
20		12	098032002
50		4	098032005
250		4	098032025

9802M

frenafiletti - media resistenza

Ideale per frenare e bloccare parti soggette a manutenzione e smontaggi periodici.

Permette lo smontaggio con l'uso di utensili manuali.



Temperatura di impiego (°C)	-50/+150
Gioco diametrale (mm)	0,15
Velocità di reazione	10/15
blocco alla mano (minuti)	
Indurimento funzionale (ore)	3-6
Viscosità (mPa.s) 25°C	500/800
Coppia di svitamento	22-30 Nm
INIZIALE (ISO-10964)	
Coppia di svitamento	20-25 Nm
RESIDUA (ISO-10964)	

ml	€	🚚	🏠
20	11,90	12	098020002
50	18,10	4	098020005
250	46,00	4	098020025
20		12	098022002
50		4	098022005
250		4	098022025

9801L

frenafiletti - bassa resistenza

Ideale per frenare particolari in leghe leggere che potrebbero danneggiarsi in fase di smontaggio o per viti di regolazione.

Permette uno smontaggio facile delle parti assemblate.



Temperatura di impiego (°C)	-50/+150
Gioco diametrale (mm)	0,10
Velocità di reazione	10/15
blocco alla mano (minuti)	
Indurimento funzionale (ore)	3-6
Viscosità (mPa.s) 25°C	500/800
Coppia di svitamento	6-10 Nm
INIZIALE (ISO-10964)	
Coppia di svitamento	4-8 Nm
RESIDUA (ISO-10964)	

ml	€	🚚	🏠
20	11,90	12	098010002
50	18,10	4	098010005
250	46,00	4	098010025
20		12	098012002
50		4	098012005
250		4	098012025

9813H

sigillaraccordi - forte resistenza

Ideale per sigillatura permanente di raccordi filettati che non devono essere smontati.

Per l'applicazione su superfici metalliche passivate come ottone, alluminio e acciaio inox.

Non consente lo smontaggio con utensili manuali.



Temperatura (°C)	-50/+200
Gioco diametrale (mm)	0,15
Velocità di reazione	10/15
blocco alla mano (minuti)	
Indurimento funzionale (ore)	3-6
Viscosità (mPa.s) 25°C	40.000/80.000
Coppia di svitamento	35-45 Nm
INIZIALE (ISO-10964)	
Coppia di svitamento	25-35 Nm
RESIDUA (ISO-10964)	

ml	€	🚚	🏠
20	10,60	12	098130002
50	18,60	6	098130305
50	17,40	4	098130505
250	43,00	4	098130525
20		12	098132002
50		6	098132305
50		4	098132505
250		4	098132525

9812M

sigillaraccordi - media resistenza

Ideale per sigillare raccordi filettati soggetti a manutenzione periodica.

Permette lo smontaggio con l'uso di utensili manuali.



Temperatura (°C)	-50/+150
Gioco diametrale (mm)	0,35
Velocità di reazione	12/18
blocco alla mano (minuti)	
Indurimento funzionale (ore)	3-6
Viscosità (mPa.s) 25°C	20.000/40.000
Coppia di svitamento	27-35 Nm
INIZIALE (ISO-10964)	
Coppia di svitamento	20-30 Nm
RESIDUA (ISO-10964)	

ml	€	🚚	🏠
20	10,60	12	098120002
50	18,60	6	098120305
50	17,40	4	098120505
250	43,00	4	098120525
20		12	098122002
50		6	098122305
50		4	098122505
250		4	098122525

9811L

sigillaraccordi - bassa resistenza

Ideale per sigillare raccordi piccoli o a passo fine.

Permette uno smontaggio facile delle parti assemblate.



Temperatura (°C)	-50/+150
Gioco diametrale (mm)	0,20
Velocità di reazione	10/15
blocco alla mano (minuti)	
Indurimento funzionale (ore)	3-6
Viscosità (mPa.s) 25°C	10.000/20.000
Coppia di svitamento	6-10 Nm
INIZIALE (ISO-10964)	
Coppia di svitamento	4-8 Nm
RESIDUA (ISO-10964)	

ml	€	🚚	🏠
20	10,60	12	098110002
50	18,60	6	098110305
50	17,40	4	098110505
250	43,00	4	098110525
20		12	098112002
50		6	098112305
50		4	098112505
250		4	098112525

9823H

guarnizione liquida- alta resistenza

Ideale per sigillare superfici in modo permanente.
Ideale anche per ricostruire sedi cuscinetto o parti usurate.
Non consente lo smontaggio con utensili manuali.



Temperatura (°C)	-50/+150
Gioco diametrale (mm)	0,35
Velocità di reazione	10/16
blocco alla mano (minuti)	
Indurimento funzionale (ore)	3-6
Viscosità (mPa.s) 25°C	100.000/200.000
Coppia di svitamento	35-45 Nm
INIZIALE (ISO-10964)	
Coppia di svitamento	20-30 Nm
RESIDUA (ISO-10964)	

ml	€	Icona	Icona	ml	€	Icona	Icona
20	10,60	12	098230002	50	18,60	6	098230305
50	17,40	4	098230505	250	43,00	4	098230525
20		12	098232002	50		6	098232305
50		4	098232505	250		4	098232525

9822M

guarnizione liquida- media resistenza

Ideale per sigillare superfici di parti soggette a manutenzione periodica.
Permette lo smontaggio con l'uso di utensili manuali.



Temperatura (°C)	-50/+150
Gioco diametrale (mm)	0,35
Velocità di reazione	10/15
blocco alla mano (minuti)	
Indurimento funzionale (ore)	3-6
Viscosità (mPa.s) 25°C	40.000/70.000
Coppia di svitamento	25-35 Nm
INIZIALE (ISO-10964)	
Coppia di svitamento	20-30 Nm
RESIDUA (ISO-10964)	

ml	€	Icona	Icona	ml	€	Icona	Icona
20	10,60	12	098220002	50	18,60	6	098220305
50	17,40	4	098220505	250	43,00	4	098220525
20		12	098222002	50		6	098222305
50		4	098222505	250		4	098222525

9821L

guarnizione liquida- bassa resistenza

Ideale per sigillare superfici di parti soggette a frequente manutenzione.
Tollerata la leggera contaminazione di olii.
Protegge le filettature da corrosione e grippaggi da corrosione.
Permette uno smontaggio facile delle parti assemblate.



Temperatura (°C)	-50/+150
Gioco diametrale (mm)	0,35
Velocità di reazione	20/30
blocco alla mano (minuti)	
Indurimento funzionale (ore)	3-6
Viscosità (mPa.s) 25°C	60.000/90.000
Coppia di svitamento	7-11 Nm
INIZIALE (ISO-10964)	
Coppia di svitamento	4-9 Nm
RESIDUA (ISO-10964)	

ml	€	Icona	Icona	ml	€	Icona	Icona
20	10,60	12	098210002	50	18,60	6	098210305
50	17,40	4	098210505	250	43,00	4	098210525
20		12	098212002	50		6	098212305
50		4	098212505	250		4	098212525

9833H

bloccante - alta resistenza

Ideale per fissaggio di parti che non devono essere smontate.
Adatto fissare dispositivi già installati dove risulta difficoltoso lo smontaggio.
Non consente lo smontaggio con utensili manuali.



Temperatura (°C)	-50/+180
Gioco diametrale (mm)	0,15
Velocità di reazione	10/15
blocco alla mano (minuti)	
Indurimento funzionale (ore)	3-6
Viscosità (mPa.s) 25°C	400/700
Coppia di svitamento	35-45 Nm
INIZIALE (ISO-10964)	
Coppia di svitamento	30-40 Nm
RESIDUA (ISO-10964)	

ml	€	Icona	Icona	ml	€	Icona	Icona
20	11,20	12	098330002	50	17,40	4	098330005
50	17,40	4	098330025	20		12	098332002
20		4	098332005	50		4	098332005
250	44,50	4	098332025	250		4	098332025

9832M

bloccante - media resistenza

Ideale per fissaggio di parti soggette a manutenzione periodica.
Permette lo smontaggio con l'uso di utensili manuali.



Temperatura (°C)	-50/+180
Gioco diametrale (mm)	0,25
Velocità di reazione	12/20
blocco alla mano (minuti)	
Indurimento funzionale (ore)	3-6
Viscosità (mPa.s) 25°C	2000/4000
Coppia di svitamento	25-35 Nm
INIZIALE (ISO-10964)	
Coppia di svitamento	18-28 Nm
RESIDUA (ISO-10964)	

ml	€	Icona	Icona	ml	€	Icona	Icona
20	11,20	12	098320002	50	17,40	4	098320005
50	17,40	4	098320025	20		12	098322002
20		4	098322005	50		4	098322005
250	44,50	4	098322025	250		4	098322025

9831L

bloccante- bassa resistenza

Ideale per fissaggio di parti soggette a manutenzione frequente e di piccole dimensioni.
Permette uno smontaggio facile delle parti assemblate.



Temperatura (°C)	-50/+150
Gioco diametrale (mm)	0,10
Velocità di reazione	10/15
blocco alla mano (minuti)	
Indurimento funzionale (ore)	3-6
Viscosità (mPa.s) 25°C	500/800
Coppia di svitamento	6-10 Nm
INIZIALE (ISO-10964)	
Coppia di svitamento	4-8 Nm
RESIDUA (ISO-10964)	

ml	€	Icona	Icona	ml	€	Icona	Icona
20	11,20	12	098310002	50	17,40	4	098310005
50	17,40	4	098310025	20		12	098312002
20		4	098312005	50		4	098312005
250	44,50	4	098312025	250		4	098312025

9841N

sigillante siliconico nero a reticolazione acetica, resistente ad alte temperature, con pratico erogatore a pressione

Resiste fino a temperature di 240°C

Permette di effettuare sigillature elastiche permanenti.

Sostituisce le guarnizioni preformate.

L'erogatore consente una distribuzione facile, precisa e uniforme del prodotto.

Polimerizza reagendo all'umidità atmosferica e forma una guarnizione elastica e resistente.

Ideale per coppe olio, pompe olio, carter, scatole cambio, parti motore non soggette ad alte pressioni e applicazioni che necessitano di resistenza ad alte temperature. Aderisce a substrati non porosi, come vetro, legno verniciato, ceramica e smaltato. Non adatto per PE, PP, PC, PMMA, PTFE, plastica morbida, supporti in neoprene e bituminosi.

Non verniciabile.



ml	€		
200	28,00	12	098410120
200		12	098412120

9841R

sigillante siliconico rosso a reticolazione acetica, resistente ad alte temperature, con pratico erogatore a pressione

Resiste fino a temperature di 300°C

Permette di effettuare sigillature elastiche permanenti.

Sostituisce le guarnizioni preformate.

L'erogatore consente una distribuzione facile, precisa e uniforme del prodotto.

Polimerizza reagendo all'umidità atmosferica e forma una guarnizione elastica e resistente.

Ideale per porte di forni, piastre, sistemi di riscaldamento, scarichi, termostati, pompe, tubi di riscaldamento, parti motore non soggette ad alte pressioni e tutte le applicazioni dove è necessaria una resistenza alle alte temperature.

Aderisce a substrati non porosi, come vetro, legno verniciato, ceramica e smaltato. Non adatto per PE, PP, PC, PMMA, PTFE, plastica morbida, supporti in neoprene e bituminosi.

Non verniciabile.



ml	€		
200	26,50	12	098410020
200		12	098412020

9851

colla istantanea per giunzioni strutturali istantanee

A base di cianoacrilato etilico.

Consente l'adesione di una vasta gamma di materiali come metallo, plastiche, cuoio, legno ed altri svariati tipi di substrato anche in combinazione tra loro.

Velocità di presa Alta.



Temperatura (°C)	-55/+82
Viscosità (mPa.s) 25°C	80-120

g	€		
5	5,75	12	098510500
20	11,20	12	098510002
50	21,90	10	098510005
5		12	098512500
20		12	098512002
50		10	098512005

9710 - LUBRIBETA universal

sbloccante lubrificante multiuso 7 funzioni

1. Sbloccante;
 2. Lubrificante;
 3. Detergente;
 4. Protettivo antiruggine;
 5. Disossidante per contatti elettrici;
 6. Idrorepellente;
 7. Anticongelante
- Non contiene silicone.



ml	€		
400	9,40	12	097100040
400		12	097101040
400		12	097102040



9712 - Ultra Sblock

sbloccante, super-penetrante

Sbloccante, disossidante e idrorepellente

Ideale per sciogliere la ruggine da dadi, bulloni, viti e ingranaggi.



ml	€		
400	6,85	12	097120040
400		12	097121040
400		12	097122040

9720 - Multi Grease

grasso lubrificante spray multiuso

Particolarmente indicato per la lubrificazione di catene, ingranaggi e parti metalliche in movimento.

Resiste agli attriti e agli agenti atmosferici.

Altamente adesivo. Non cola.



ml	€		
400	7,85	12	097200040
400		12	097201040
400		12	097202040

9722 - Lithium Grease

grasso bianco spray al litio

A base di grassi saponificati di litio, titanio e ossidi di zinco.

Ideale per ingranaggi, cuscinetti e giunti. Specifico per applicazioni marine.

Fortemente resistente ad acqua, salsedine, agenti atmosferici e alte temperature.

Non cola.



ml	€		
400	8,85	12	097220040
400		12	097221040
400		12	097222040

9724 - PTFE Grease

grasso spray a base di P.T.F.E.

Particolarmente indicato per lubrificazione di catene industriali e movimenti meccanici a forti pressione e rotazioni non elevate.

Adatto per applicazioni su plastica e gomma.

Totalmente incolore. Idrorepellente e resistente all'ossidazione.



ml	€	12	097240040
400	10,10	12	097240040
400		12	097241040
400		12	097242040

9726 - Copper Grease

grasso spray al rame micronizzato

Per lubrificazione di giunti, bulloni, ingranaggi, alberi motore e altre parti metalliche soggette ad elevate temperature (fino a 1.000° C).

Protettivo, anti-usura. Previene l'ossidazione. Non cola.



ml	€	12	097260040
400	11,90	12	097261040
400		12	097262040

9729 - Silic Spray

silicone spray

Adatto per la lubrificazione dei parti in plastica, gomma e metalli.

Protegge dalla corrosione. Distaccante. Antistatico.

Idrorepellente.

Lucidante per legno, plastica e gomma. Non contiene solventi.



ml	€	12	097290040
400	6,85	12	097291040
400		12	097292040

9738 - Cutting Oil

olio da taglio

Ad alto potere lubrificante e protettivo.

Indicato per fresatura, alesatura, filettatura, foratura e lavorazioni per macchine manuali e automatiche.

Elevata resistenza all'ossidazione.

Lavabile con acqua. Non contiene solventi.



ml	€	12	097380040
400	7,45	12	097381040
400		12	097382040

9740 - Brake Cleaner

pulitore per freni

Ideale per la pulizia di dischi e pastiglie freno, motori.

Elimina grasso e catrame, senza lasciare residui.

Ad evaporazione rapida. Non intacca gomma e plastica.



ml	€	12	097400050
500	6,70	12	097401050
500		12	097402050

9741 - Multi Cleaner

detergente, sgrassante multiuso

Detergente e sgrassante per sciogliere grasso, olio, catrame, silicone e colla.

Adatto per pulizia di superfici in metallo, plastica rigida, ceramica, acciaio e alluminio.

Non lascia residui oleosi.



ml	€	12	097410040
400	7,35	12	097411040
400		12	097412040

9742 - Contact Cleaner

pulitore per contatti elettrici ed elettronici

Elimina unto e sporco, senza lasciare residui oleosi.

Ad evaporazione rapida. Non intacca plastica e gomma.



ml	€	12	097420040
400	7,35	12	097421040
400		12	097422040

9743 - SURFACE CLEANER

detergente schiumogeno

Detergente schiumogeno per tutti i tipi di superfici, utensili e tessuti.

A base di sali quaternari di ammonio, crea una schiuma attiva che pulisce e rimuove sporco e unto.

Rimuove i cattivi odori. Non serve risciacquo. Non è un disinfettante.



ml	€	12	097430050
500	14,20	12	097431050
500		12	097432050

9745 - Carb Cleaner

pulitore per carburatori e corpi farfallati

Specifico per la pulizia interna ed esterna di carburatori, condotti di aspirazione e corpi farfallati.

Elimina totalmente i residui carboniosi, depositi e impurità.

Non lascia residui oleosi.



ml	€	12	097450040
400	9,90	12	097451040
400		12	097452040

9746 - Clima Cleaner

pulitore per climatizzatori

Pulitore per climatizzatori e condizionatori industriali, civili e auto. Grazie alla sua formulazione schiumogena densa e alla cannuccia in dotazione, consente di eliminare sporco, incrostazioni ed odori all'interno dei condotti, lasciando una gradevole fragranza.



ml	€		
400	12,30	12	097460040
400		12	097461040
400		12	097462040

9749 - Air Spray

aria spray

Aerosol a base di gas compresso. Ideale per eliminare depositi di polvere in fessure, ingranaggi, componenti elettrici, tastiere e meccanismi delicati in genere. L'erogatore con tubicino consente di raggiungere in profondità anche parti poco accessibili.



ml	€		
400	7,85	12	097490040
400		12	097491040
400		12	097492040

9752 - Zinc 98%

zinco chiaro

Con elevato potere coprente, è ideale per zincare parti in ferro.

Fortemente adesivo, crea un film elastico di colore molto chiaro, simile alla zincatura a caldo.

Particolarmente resistente a ossidazione, abrasione e agenti atmosferici.

Può essere sovra-verniciato. Non cola.



ml	€		
400	8,55	12	097520040
400		12	097521040
400		12	097522040

9755 - Welding Spray

antiadesivo per saldatura

Antiadesivo per saldatura senza siliceni. Evita l'adesione di scorie, facilitando e velocizzando l'operazione di saldatura. Da utilizzare su parti da saldare e come protettivo per gli ugelli delle torce di saldatura. Consente lavorazioni successive come verniciatura, zincatura e cromatura. Non produce fumi. Facile da asportare. Non contiene clorurati.



ml	€		
400	7,75	12	097550040
400		12	097551040
400		12	097552040

9765 - Deicer Spray

deghiacciante spray

Deghiacciante e sbrinatori spray, per sciogliere ghiaccio e brina da vetri e cristalli. Ideale anche per serrature e meccanismi bloccati dal ghiaccio. Agisce fino a -40°C. Non unge e non lascia aloni. Non intacca le superfici trattate, gomma e plastica.



ml	€		
400	12,90	12	097650040
400		12	097651040
400		12	097652040

9775 - Water Stop

impermeabilizzante per tessuti

Impermeabilizzante, idrorepellente per tessuti, cuoio e pelle.

Ideale per scarpe, giacche e abiti in genere. Consente di impermeabilizzare i tessuti, senza comprometterne la

traspirabilità. Il potere antimacchia rende i tessuti più

facilmente lavabili. Migliora la resistenza alla flessione e

all'abrasione.



ml	€		
400	13,90	12	097750040
400		12	097751040
400		12	097752040

9881U

detergente industriale alcalino per vasca ultrasuoni.

Detergente industriale alcalino, concentrato, a base acqua. Per pulizia ad ultrasuoni e altri processi di purificazione. Consente una pulizia accurata ed efficace di parti di ricambio e pezzi metallici in genere (iniettori, carburatori, valvole, ecc.). Rimuove oli, grassi, lubrificanti, residui di colla, resine, cere. Adatto anche per la pulizia di parti in alluminio.



Lt	€		
1	36,00	1	098810010
1		1	098812010

9882R

liquido distaccante selettivo di ruggine.

Liquido distaccante selettivo di ruggine a base acqua per ferro, acciaio, acciaio inox, ghisa e cromature. Rimuove lo strato ossidato, senza danneggiare il substrato metallico.

Diluizione: da puro a max 1:1.

Temperatura minima di utilizzo: 15°C.

Tempi utilizzo: 30' - 24/48h (per ruggine consistente).

Biodegradabile e 100% idrosolubile.



Lt	€		
1	43,50	1	098820010
1		1	098822010



Una gamma completa di abrasivi rigidi e flessibili, composta da più di 400 referenze prodotte interamente in Italia. Nata e sviluppata per soddisfare ogni esigenza industriale e professionale di taglio o asportazione di materiale. Con il progetto Beta Abrasives, Beta Utensili afferma la sua volontà di offrire una gamma di prodotti completa e un servizio tecnico assoluto ai professionisti del mercato, garantito dalle competenze produttive apportate da AbraBeta.

DISCHI RIGIDI da taglio e da sbavo



I dischi rigidi rappresentano la categoria più importante di questa famiglia di prodotti, per questo motivo Beta Utensili ha posto la massima attenzione nella scelta dei materiali utilizzati e delle tipologie adottate.

I dischi da taglio e sbavo sono gli strumenti più rapidi e polivalenti per la lavorazione di un'ampia varietà di materiali, mediante l'utilizzo degli utensili più indicati, siano essi smerigliatrici angolari o macchine stazionarie.

FORME dei dischi



T42

disco da taglio con centro depresso

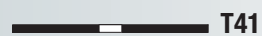

T41

disco da taglio con centro piano



T27

disco da sbavo con centro depresso



La qualità senza compromessi: destinati ad utilizzatori estremamente esigenti.



Alta qualità per grandi prestazioni, con un prezzo competitivo, per il miglior rapporto qualità/prezzo.

CERTIFICAZIONI



PITTOGRAMMI presenti sui dischi



Usare occhiali protettivi



Usare guanti protettivi



Usare cuffie antirumore



Usare abbigliamento protettivo



Usare maschera antipolvere



Consultare il manuale d'istruzioni



Disco solo per taglio – non adatto per sbavare



Non usare il disco se danneggiato



Esente da ferro, zolfo e cloro ($\leq 0,1\%$)

Validità del prodotto

La validità dei dischi è di 3 anni a partire dalla data di produzione. La dicitura "V01" incisa sulla rondella metallica al centro del disco indica il trimestre di scadenza. Esempio: la dicitura "V07/2022" indica che il disco è stato prodotto nel 3° trimestre 2019 e può essere utilizzata fino alla fine del 3° trimestre 2022.



	Trimestre
V01	Gen-Mar
V04	Apr-Giu
V07	Lug-Set
V10	Ott-Dic



MOLE CON GAMBO

Mole abrasive con gambo per utilizzo con smerigliatrici assiali. Realizzate in varie forme per adattarsi alle differenti lavorazioni e con due tipologie di abrasivo.



RUOTE CON GAMBO

Le ruote lamellari con gambo sono prodotte con lamelle flessibili per ottenere finiture precise ed omogenee su forme e superfici irregolari.



DISCHI LAMELLARI

I dischi lamellari sono composti da lamelle di tela abrasiva incollate ad un supporto; sono un'ottima scelta per operazioni di sgrossatura e di finitura. In generale, rispetto ai dischi da sbavo, garantiscono un'asportazione più veloce, finitura più omogenea, minori vibrazioni, meno rumore e temperature di lavoro inferiori. Sono disponibili con tele di vari materiali abrasivi con differenti granulometrie e due tipi diversi di supporto.

Esecuzioni



Profilo piano

Si utilizza con un angolo massimo di 15° rispetto al piano di lavoro e permette la lavorazione di superfici piane e spigoli.



Profilo conico

Semplifica le operazioni su superfici accidentate e si utilizza con un angolo tra i 15° e i 25° rispetto al piano di lavoro. Assicura una maggiore superficie di contatto tra il disco e la superficie di lavorazione. Le lamelle possono essere utilizzate fino al loro completo esaurimento.



La qualità senza compromessi: destinati ad utilizzatori estremamente esigenti.



Alta qualità per grandi prestazioni, con un prezzo competitivo, per il miglior rapporto qualità/prezzo.



RUOTE CON FORO

Le ruote lamellari su flangia sono prodotti idonei per la lavorazione di bordi, contorni e superfici irregolari grazie all'elevata flessibilità delle lamelle.



RUOTE PER SATINATRICI

Le ruote (o rulli) per satinatrici Beta rappresentano la soluzione migliore per la finitura di qualsiasi materiale.

Gradi di grana/finitura	
C	Grossolana (Coarse)
M	Media (Medium)
F	Fine (Fine)
VF	Molto fine (Very Fine)
UF	Ultra fine



DISCHI RADIALI E DISCHI FIBRATI

Dischi speciali in tessuto non tessuto (TNT) con elevate capacità di lucidatura che permettono lavorazioni veloci e precise.

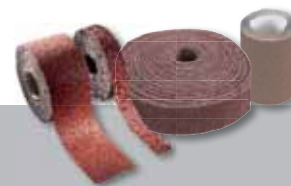

ROTOI ANTISPRECO

Un'ampia offerta di rotoli antispresco di tela e carta abrasiva e di tessuto non tessuto, di ottima qualità per gli utilizzi più vari.

Per qualsiasi ulteriore informazione si prega di fare riferimento al catalogo dedicato disponibile sul sito Beta:
www.beta-tools.com

11001
dischi abrasivi da taglio per acciaio
esecuzione a centro depresso

A30S EN 12413



	Ø mm	S mm	F mm	max. rpm	€	10	110010118
11001	115	3,2	22,23	13300	1,87	10	110010118
11001	125	3,2	22,23	12200	1,98	10	110010128
11001	230	3,2	22,23	6600	4,30	10	110010233

11001H
dischi abrasivi da taglio per acciaio
esecuzione a centro depresso

come 11001 versione rigida - HARD

A30T EN 12413



	Ø mm	S mm	F mm	max. rpm	€	10	110010733
11001H	230	3,2	22,23	6600	4,30	10	110010733

11003
dischi abrasivi da taglio per acciaio
esecuzione a centro piano

A30T EN 12413



	Ø mm	S mm	F mm	max. rpm	€	10	110030117
11003	115	2,5	22,23	13300	1,76	10	110030117
11003	125	2,5	22,23	12200	1,76	10	110030127
11003	180	2,5	22,23	8500	3,65	10	110030182
11003	230	2,5	22,23	6600	4,05	10	110030232

11011
dischi abrasivi da sbavo per acciaio
esecuzione a centro depresso

A24N EN 12413



	Ø mm	S mm	F mm	max. rpm	€	10	110110115
11011	115	6,5	22,23	13300	2,53	10	110110115
11011	125	6,5	22,23	12200	2,75	10	110110125
11011	180	6,5	22,23	8500	5,30	10	110110180
11011	230	6,5	22,23	6600	7,90	10	110110230

11011H
dischi abrasivi da sbavo per acciaio
esecuzione a centro depresso

come 11011 versione rigida - HARD

A24R EN 12413



	Ø mm	S mm	F mm	max. rpm	€	10	110110615
11011H	115	6,5	22,23	13300	2,53	10	110110615
11011H	125	6,5	22,23	12200	2,75	10	110110625
11011H	180	6,5	22,23	8500	5,30	10	110110680
11011H	230	6,5	22,23	6600	7,90	10	110110730

11018
dischi abrasivi per troncatura acciaio
esecuzione a centro piano

velocità max. 60 m/s

A46N EN 12413



	Ø mm	S mm	F mm	max. rpm	€	10	110180030
11018	300	2,5	25,40	4010	7,05	10	110180030
11018	350	3,0	25,40	3440	11,00	10	110180035
11018	400	3,2	25,40	3010	14,00	10	110180040

11019
dischi abrasivi per troncare **acciaio**
esecuzione a **centro piano**

velocità max. 80 m/s
A24N EN 12413



A24N

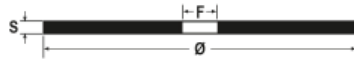

	Ø mm	S mm	F mm	max. rpm	€		
11019	300	3,8	25,40	5100	8,60	10	110190030
11019	350	4,2	25,40	4400	13,00	10	110190035
11019	400	4,5	25,40	3800	16,80	10	110190040

11021
dischi abrasivi da taglio per **acciaio e inox**
esecuzione a **centro depresso**

A30Q EN 12413



A30Q

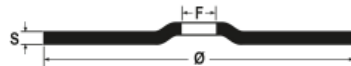

	Ø mm	S mm	F mm	max. rpm	€		
11021	115	3,2	22,23	13300	1,87	10	110210118
11021	125	3,2	22,23	12200	1,98	10	110210128
11021	180	3,2	22,23	8500	3,75	10	110210183
11021	230	3,2	22,23	6600	4,30	10	110210233

11023
dischi abrasivi da sbavo per **acciaio e inox**
esecuzione a **centro depresso**

A24Q EN 12413



A24Q

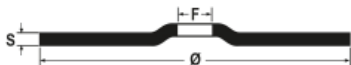

	Ø mm	S mm	F mm	max. rpm	€		
11023	115	6,5	22,23	13300	2,53	10	110230115
11023	125	6,5	22,23	12200	2,75	10	110230125
11023	230	6,5	22,23	6600	7,90	10	110230230

11024
dischi abrasivi da taglio per **acciaio e inox**
esecuzione di **spessore sottile e a centro depresso**

TOP LINE
A46U EN 12413



TOP
LINE

A46U

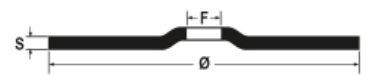

	Ø mm	S mm	F mm	max. rpm	€		
11024	230	2,0	22,23	6600	5,30	10	110240230

11031÷11038
dischi abrasivi da taglio per **acciaio e inox**
esecuzione di **spessore sottile e a centro piano**

TOP LINE
A46U EN 12413



TOP
LINE

A46U

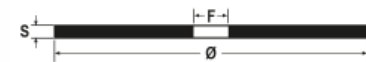

	Ø mm	S mm	F mm	max. rpm	€		
11031	65	1,0	6,00	24000	1,65	25	110310006
11031	65	1,0	10,00	24000	1,65	25	110310010
11031	65	1,6	10,00	24000	1,65	25	110310020

	Ø mm	S mm	F mm	max. rpm	€		
11032	76	1,0	6,00	20200	1,65	25	110320006
11032	76	1,0	10,00	20200	1,65	25	110320010
11032	76	1,6	10,00	20200	1,65	25	110320020

	Ø mm	S mm	F mm	max. rpm	€		
11034	115	1,0	22,23	13300	2,42	25	110340022
11034	115	1,2	22,23	13300	2,42	25	110340042
11034	115	1,6	22,23	13300	2,42	25	110340062

	Ø mm	S mm	F mm	max. rpm	€		
11035	125	1,0	22,23	12200	2,64	25	110350022
11035	125	1,2	22,23	12200	2,64	25	110350042
11035	125	1,6	22,23	12200	2,64	25	110350062

	Ø mm	S mm	F mm	max. rpm	€		
11037	180	2,0	22,23	8500	4,30	10	110370022

	Ø mm	S mm	F mm	max. rpm	€		
11038	230	2,0	22,23	6600	4,95	10	110380022

11040
dischi abrasivi da taglio per **acciaio e inox**
esecuzione di **spessore sottile** e a **centro depresso**

PREMIUM LINE
A36Q EN 12413



A36Q

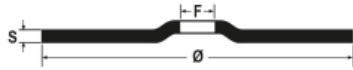
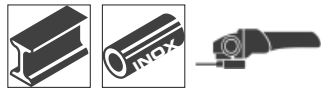

	Ø mm	S mm	F mm	max. rpm	€	10	110400230
11040	230	2,0	22,23	6600	4,05	10	110400230

11045-11046
dischi abrasivi da taglio per **acciaio e inox**
esecuzione di **spessore sottile** e a **centro piano**

PREMIUM LINE
A46Q EN 12413



A46Q

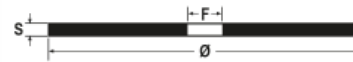

	Ø mm	S mm	F mm	max. rpm	€	25	110450010
11045	115	1,0	22,23	13300	1,87	25	110450010
11045	115	1,2	22,23	13300	1,87	25	110450012
11045	115	1,6	22,23	13300	1,87	25	110450016

	Ø mm	S mm	F mm	max. rpm	€	25	110460010
11046	125	1,0	22,23	12200	1,98	25	110460010
11046	125	1,2	22,23	12200	1,98	25	110460012
11046	125	1,6	22,23	12200	1,98	25	110460016

11048-11049
dischi abrasivi da taglio per **acciaio e inox**
esecuzione di **spessore sottile** e a **centro piano**

PREMIUM LINE
A36Q EN 12413



A36Q

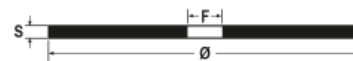

	Ø mm	S mm	F mm	max. rpm	€	10	110480019
11048	180	2,0	22,23	8500	2,86	10	110480019

	Ø mm	S mm	F mm	max. rpm	€	10	110490019
11049	230	2,0	22,23	6600	3,85	10	110490019

11050
dischi abrasivi da sbavo per **acciaio e ghisa**
esecuzione allo **zirconio** e a **centro depresso**

ZA24R - EN 12413



ZA24R

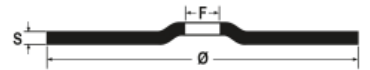

	Ø mm	S mm	F mm	max. rpm	€	10	110500115
11050	115	6,5	22,23	13300	4,30	10	110500115
11050	125	6,5	22,23	12200	5,15	10	110500125
11050	230	7,0	22,23	6600	13,00	10	110500230

11069
dischi abrasivi da taglio per **pietra e marmo**
esecuzione a **centro depresso**

C30S EN 12413



C30S

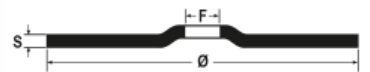

	Ø mm	S mm	F mm	max. rpm	€	10	110690115
11069	115	3,2	22,23	13300	1,98	10	110690115
11069	125	3,2	22,23	12200	2,09	10	110690125
11069	230	3,2	22,23	6600	4,60	10	110690230



11100

mole abrasive con gambo
granuli abrasivi di corindone rosa
forma cilindrica

gambo Ø 3 x 37 mm

EN 12413

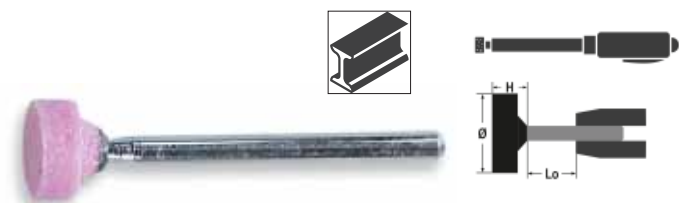

	Ø mm	h mm	max. rpm Lo=13 mm		€		
11100	4	8	130.000	AR60P5V	1,07	25	111000004
11100	6	10	93.100	AR60P5V	1,07	25	111000006
11100	8	12	64.500	AR60P5V	1,07	25	111000008
11100	10	10	60.100	AR60P5V	1,07	25	111000011
11100	10	12	52.700	AR60P5V	1,07	25	111000012
11100	12	15	37.300	AR60P5V	1,18	25	111000013

11101

mole abrasive con gambo
granuli abrasivi di corindone rosa
forma cilindrica

gambo Ø 6 x 40 mm

EN 12413

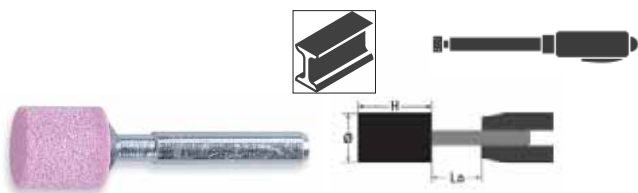

	Ø mm	h mm	max. rpm Lo=13 mm		€		
11101	4	8	130.000	AR60P5V	1,25	25	111010004
11101	5	10	130.000	AR60P5V	1,25	25	111010005
11101	6	10	130.000	AR60P5V	1,25	25	111010006
11101	8	10	119.300	AR60P5V	1,25	25	111010008
11101	10	10	95.400	AR60P5V	1,25	25	111010010
11101	10	15	95.400	AR60P5V	1,25	25	111010011
11101	10	20	86.600	AR60P5V	1,36	25	111010012
11101	10	25	72.700	AR60P5V	1,51	25	111010013
11101	10	32	58.700	AR60P5V	1,58	25	111010014
11101	12	10	79.500	AR60P5V	1,16	25	111010015
11101	12	15	79.500	AR60P5V	1,18	25	111010016
11101	12	20	79.500	AR60P5V	1,29	25	111010017
11101	15	3	63.600	AR60P5V	1,16	25	111010018
11101	15	15	63.600	AR60P5V	1,25	25	111010019
11101	16	20	59.600	AR46P5V	1,41	25	111010020
11101	16	25	56.900	AR46P5V	1,51	25	111010021
11101	16	32	45.100	AR46P5V	1,69	25	111010022
11101	20	4	47.700	AR60P5V	1,16	25	111010023
11101	20	15	47.700	AR46P5V	1,25	25	111010024
11101	20	20	47.700	AR46P5V	1,51	25	111010025
11101	20	25	46.100	AR46P5V	1,58	25	111010026
11101	20	30	38.900	AR46P5V	1,74	25	111010027
11101	20	40	29.000	AR46P5V	2,18	25	111010028
11101	25	10	38.100	AR60P5V	1,25	25	111010030
11101	25	25	37.200	AR36/46P5V	1,74	25	111010031
11101	25	40	23.300	AR36/46P5V	2,55	10	111010032
11101	30	10	31.800	AR60P5V	1,41	25	111010034
11101	30	30	26.200	AR36/46P5V	2,08	25	111010035
11101	30	40	19.500	AR36/46P5V	2,76	10	111010036
11101	32	20	29.800	AR36P5V	1,95	25	111010037
11101	32	32	23.100	AR36P5V	2,66	10	111010038
11101	40	10	23.800	AR36/46P5V	2,08	25	111010041
11101	40	20	23.800	AR36P5V	2,76	10	111010042
11101	40	25	23.400	AR36P5V	2,90	10	111010043
11101	40	30	19.700	AR36P5V	3,20	10	111010044
11101	40	40	14.700	AR36P5V	3,85	10	111010045
11101	50	15	19.000	AR36P5V	3,10	10	111010051
11101	50	25	18.800	AR36P5V	3,70	10	111010052
11101	60	10	15.900	AR36P5V	3,40	10	111010060

11102

mole abrasive con gambo
granuli abrasivi di corindone rosa
forma cilindrica

gambo Ø 6 x 80 mm

EN 12413

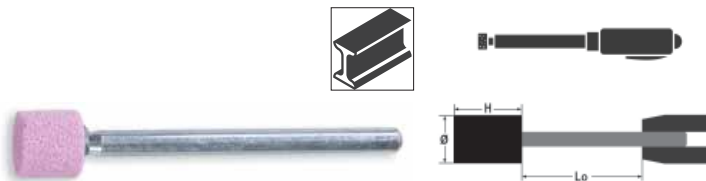

	Ø mm	h mm	max. rpm Lo=13 mm		€		
11102	8	20	100.500	AR60P5V	1,63	25	111020008
11102	10	15	95.400	AR60P5V	1,54	25	111020010
11102	10	30	62.200	AR60P5V	1,88	25	111020020
11102	12	15	79.500	AR60P5V	1,58	25	111020022
11102	15	15	63.600	AR60P5V	1,69	25	111020035
11102	15	30	51.000	AR46P5V	2,11	25	111020040
11102	20	30	38.900	AR46P5V	2,13	25	111020060

11105

mole abrasive con gambo
granuli abrasivi di corindone rosa
forma cilindro triangolare

gambo Ø 6 x 40 mm

EN 12413

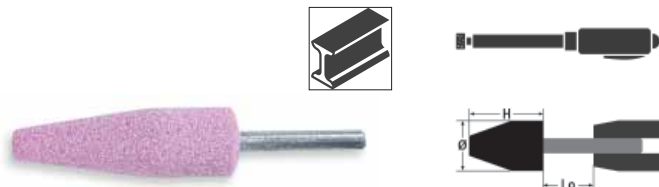

	Ø mm	h mm	max. rpm Lo=13 mm		€		
11105	20	65	16.200	AR36/46P5V	4,05	25	111050020

11106

mole abrasive con gambo
granuli abrasivi di corindone rosa
forma trapezoidale

gambo Ø 3 x 37 mm

EN 12413

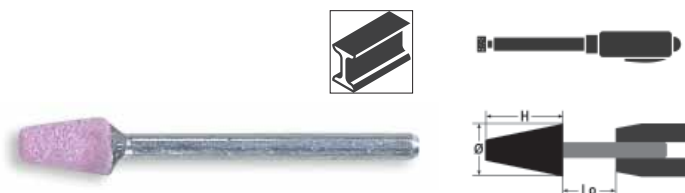

	Ø mm	h mm	max. rpm Lo=13 mm		€		
11106	6	10	93.100	AR60P5V	1,41	25	111060006

11107
mole abrasive con gambo
granuli abrasivi di corindone rosa
forma trapezoidale

gambo Ø 6 x 40 mm

EN 12413

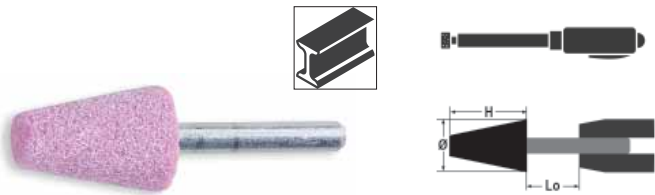

	Ø mm	h mm	max. rpm Lo=13 mm		€		
11107	12	20	79.500	AR60P5V	1,58	25	111070012
11107	15	25	60.400	AR46P5V	1,88	25	111070015
11107	20	30	38.900	AR46P5V	2,18	25	111070020
11107	25	40	23.300	AR36/46P5V	3,20	10	111070025

11110
mole abrasive con gambo
granuli abrasivi di corindone rosa
forma conica arrotondata

gambo Ø 3 x 37 mm

EN 12413



	Ø mm	h mm	max. rpm Lo=13 mm		€		
11110	10	15	44.300	AR60P5V	1,41	25	111100010

11111
mole abrasive con gambo
granuli abrasivi di corindone rosa
forma conica arrotondata

gambo Ø 6 x 40 mm

EN 12413



	Ø mm	h mm	max. rpm Lo=13 mm		€		
11111	10	20	86.600	AR60P5V	1,63	25	111110010
11111	15	30	51.000	AR46P5V	2,13	25	111110015
11111	16	45	31.400	AR46P5V	2,90	25	111110016
11111	20	28	41.500	AR46P5V	2,18	25	111110020
11111	20	40	29.000	AR46P5V	2,76	25	111110021
11111	30	50	15.100	AR36/46P5V	4,05	10	111110030

11115
mole abrasive con gambo
granuli abrasivi di corindone rosa
forma ad ogiva

gambo Ø 3 x 37 mm

EN 12413

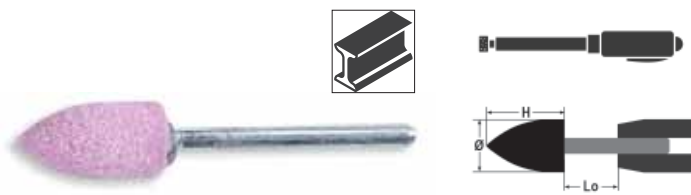

	Ø mm	h mm	max. rpm Lo=13 mm		€		
11115	10	20	34.700	AR60P5V	1,51	25	111150010

11116
mole abrasive con gambo
granuli abrasivi di corindone rosa
forma ad ogiva

gambo Ø 6 x 40 mm

EN 12413

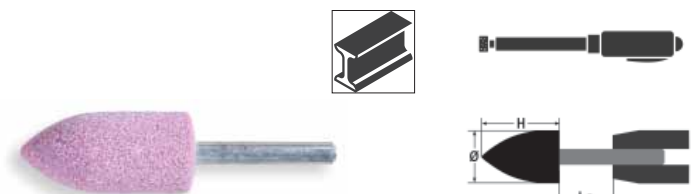

	Ø mm	h mm	max. rpm Lo=13 mm		€		
11116	10	20	86.600	AR60P5V	1,63	25	111160010
11116	18	30	43.000	AR46P5V	2,18	25	111160018
11116	20	50	22.500	AR36/46P5V	3,40	25	111160020
11116	22	70	13.400	AR36/46P5V	5,15	10	111160022

11120
mole abrasive con gambo
granuli abrasivi di corindone rosa
forma cilindro piramidale

gambo Ø 3 x 37 mm

EN 12413

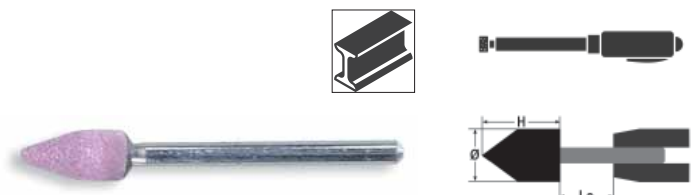

	Ø mm	h mm	max. rpm Lo=13 mm		€		
11120	6	13	77.800	AR60P5V	1,41	25	111200006

Beta

11121

mole abrasive con gambo
granuli abrasivi di corindone rosa
forma cilindro piramidale

gambo Ø 6 x 40 mm

EN 12413

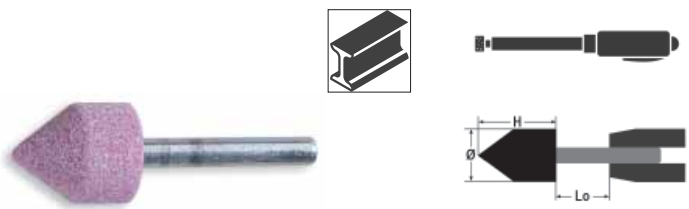

	Ø mm	h mm	max. rpm Lo=13 mm		€		
11121	6	25	100.700	AR60P5V	2,18	25	111210007
11121	12	20	79.500	AR60P5V	1,58	25	111210012
11121	20	25	46.100	AR46P5V	1,97	25	111210020
11121	25	25	37.200	AR36/46P5V	2,18	25	111210025
11121	30	30	26.200	AR36/46P5V	2,60	25	111210030

11125

mole abrasive con gambo
granuli abrasivi di corindone rosa
forma cilindro arrotondato

gambo Ø 6 x 40 mm

EN 12413

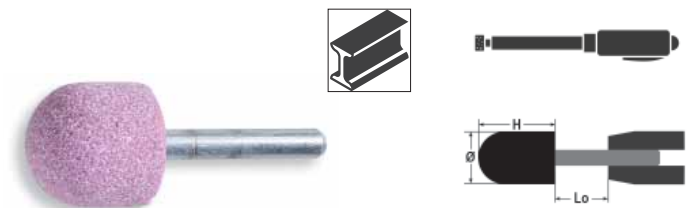

	Ø mm	h mm	max. rpm Lo=13 mm		€		
11125	6	20	117.700	AR60P5V	1,77	25	111250006
11125	25	25	37.200	AR36/46P5V	2,18	25	111250025
11125	30	50	15.100	AR36/46P5V	4,05	10	111250030
11125	40	40	14.700	AR36P5V	4,95	10	111250040

11130

mole abrasive con gambo
granuli abrasivi di corindone rosa
forma sferica

gambo Ø 3 x 37 mm

EN 12413

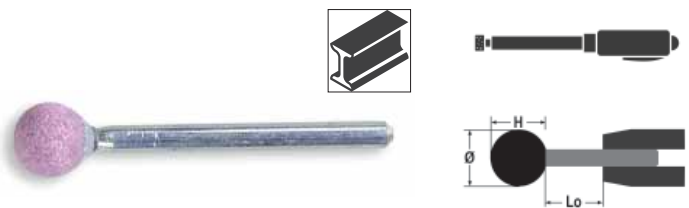

	Ø mm	h mm	max. rpm Lo=13 mm		€		
11130	6	6	124.900	AR60P5V	1,41	25	111300006
11130	8	8	84.800	AR60P5V	1,41	25	111300008
11130	10	10	60.100	AR60P5V	1,41	25	111300010

11131

mole abrasive con gambo
granuli abrasivi di corindone rosa
forma sferica

gambo Ø 6 x 40 mm

EN 12413

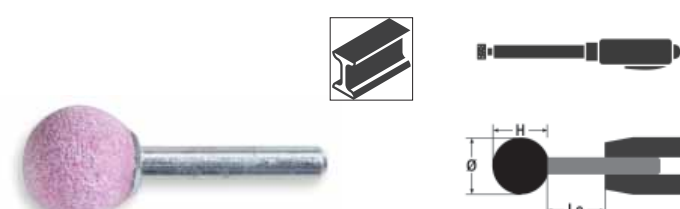

	Ø mm	h mm	max. rpm Lo=13 mm		€		
11131	10	10	95.400	AR60P5V	1,51	25	111310010
11131	15	15	63.600	AR60P5V	1,58	25	111310015
11131	20	20	47.700	AR46P5V	1,88	25	111310020
11131	25	25	37.200	AR36/46P5V	2,18	25	111310025
11131	30	30	26.200	AR36/46P5V	2,60	25	111310030

11132

mole abrasive con gambo
granuli abrasivi di corindone rosa
forma sferica

gambo Ø 6 x 80 mm

EN 12413

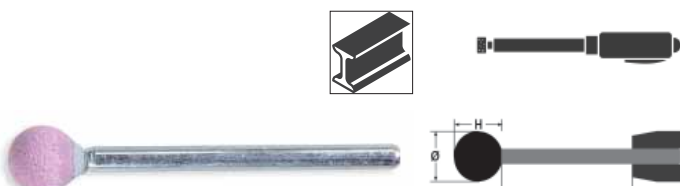

	Ø mm	h mm	max. rpm Lo=13 mm		€		
11132	10	10	95.400	AR60P5V	1,77	25	111320010
11132	15	15	63.600	AR60P5V	1,97	25	111320015
11132	20	20	47.700	AR46P5V	2,33	25	111320020

11135

mole abrasive con gambo
granuli abrasivi di corindone rosa
forma a disco

gambo Ø 6 x 40 mm

EN 12413

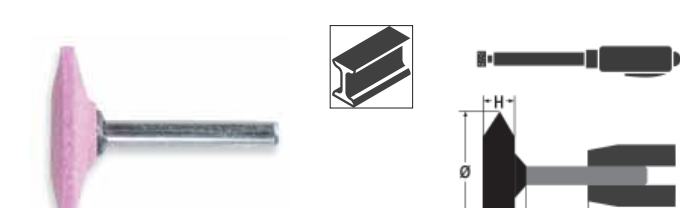

	Ø mm	h mm	max. rpm Lo=13 mm		€		
11135	30	6	31.800	AR60P5V	1,74	25	111350030
11135	40	10	23.800	AR36/46P5V	2,66	25	111350040

11140

mole abrasive con gambo
granuli abrasivi di corindone grigio/rosa
forma cilindrica

gambo Ø 6 x 40 mm

EN 12413

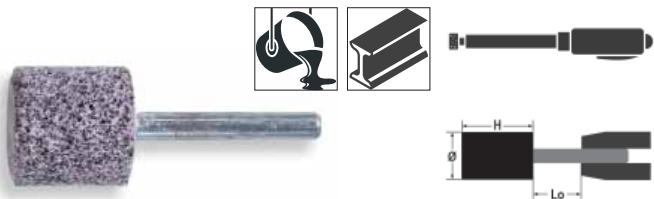

	Ø mm	h mm	max. rpm Lo=13 mm		€		
11140	20	30	38.900	A/AR24R5V	1,74	25	111400020
11140	25	25	37.200	A/AR24R5V	1,74	25	111400025
11140	30	30	26.200	A/AR24R5V	2,08	25	111400030
11140	50	10	19.000	A/AR24R5V	2,76	10	111400050

11141

mole abrasive con gambo
granuli abrasivi di corindone grigio/rosa
forma cilindrica

gambo Ø 8 x 40 mm

EN 12413



	Ø mm	h mm	max. rpm Lo=13 mm		€		
11141	20	40	46.800	A/AR24R5V	2,45	25	111410020
11141	30	40	31.800	A/AR24R5V	2,98	10	111410030
11141	40	40	23.800	A/AR24R5V	4,20	10	111410040

11145

mole abrasive con gambo
granuli abrasivi di corindone grigio/rosa
forma ad ogiva

gambo Ø 6 x 40 mm

EN 12413

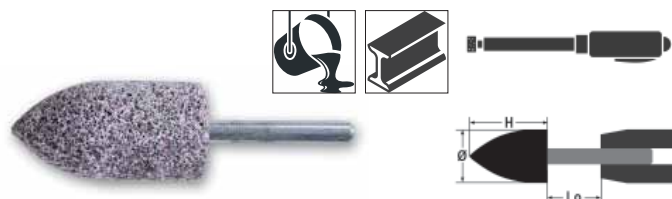

	Ø mm	h mm	max. rpm Lo=13 mm		€		
11145	20	30	38.900	A/AR24R5V	2,18	25	111450020
11145	25	50	18.100	A/AR24R5V	3,85	10	111450025

11200A-11200B

dischi lamellari con tela abrasiva allo zirconio
supporto in plastica e lamella singola

Esecuzione piana

PREMIUM LINE

EN 13743

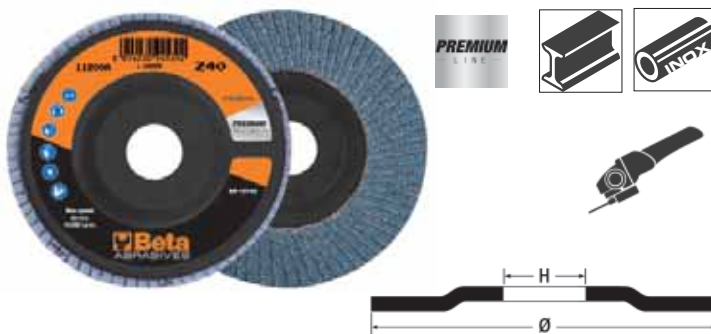

	Ø mm	P	F mm		€		
11200A	115	40	22,23		3,10	10	112000004
11200A	115	60	22,23		3,10	10	112000006
11200A	115	80	22,23		3,10	10	112000008
11200A	115	120	22,23		3,10	10	112000012

	Ø mm	P	F mm		€		
11200B	125	40	22,23		3,75	10	112000104
11200B	125	60	22,23		3,75	10	112000106
11200B	125	80	22,23		3,75	10	112000108

11202A÷11202C

dischi lamellari con tela abrasiva allo zirconio
supporto in plastica e lamella doppia

Esecuzione piana

PREMIUM LINE

EN 13743

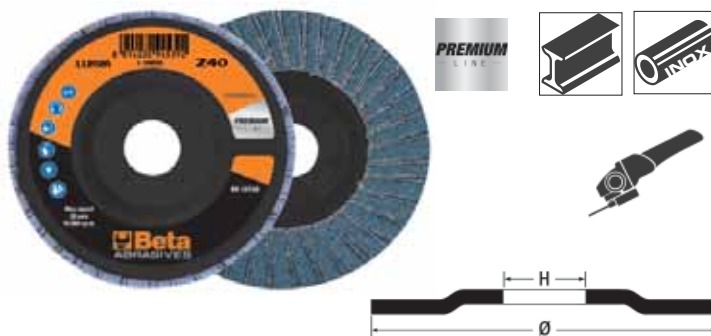

	Ø mm	P	F mm		€		
11202A	115	40	22,23		3,10	10	112020004
11202A	115	60	22,23		3,10	10	112020006
11202A	115	80	22,23		3,10	10	112020008
11202A	115	120	22,23		3,10	10	112020012

	Ø mm	P	F mm		€		
11202B	125	40	22,23		3,75	10	112020104
11202B	125	60	22,23		3,75	10	112020106
11202B	125	80	22,23		3,75	10	112020108

	Ø mm	P	F mm		€		
11202C	180	40	22,23		7,90	10	112020204
11202C	180	60	22,23		7,90	10	112020206

11204A-11204B

dischi lamellari con tela abrasiva allo zirconio
supporto in fibra di vetro e lamella singola

Esecuzione piana
PREMIUM LINE
EN 13743



	Ø mm	P	F mm	€		
11204A	115	40	22,23	3,10	10	112040004
11204A	115	60	22,23	3,10	10	112040006
11204A	115	80	22,23	3,10	10	112040008
11204A	115	120	22,23	3,10	10	112040012

	Ø mm	P	F mm	€		
11204B	125	40	22,23	3,75	10	112040104
11204B	125	60	22,23	3,75	10	112040106
11204B	125	80	22,23	3,75	10	112040108

11208A-11208B

dischi lamellari con tela abrasiva allo zirconio
supporto in fibra di vetro e lamella doppia

Esecuzione piana
PREMIUM LINE
EN 13743



	Ø mm	P	F mm	€		
11208A	115	40	22,23	3,10	10	112080004
11208A	115	60	22,23	3,10	10	112080006

	Ø mm	P	F mm	€		
11208B	125	40	22,23	3,75	10	112080104
11208B	125	60	22,23	3,75	10	112080106

11210A-11210B

dischi lamellari con tela abrasiva allo zirconio
supporto in fibra di vetro e lamella singola

Esecuzione conica
PREMIUM LINE
EN 13743



	Ø mm	P	F mm	€		
11210A	115	40	22,23	3,10	10	112100004
11210A	115	60	22,23	3,10	10	112100006
11210A	115	80	22,23	3,10	10	112100008
11210A	115	120	22,23	3,10	10	112100012

	Ø mm	P	F mm	€		
11210B	125	40	22,23	3,75	10	112100104
11210B	125	60	22,23	3,75	10	112100106
11210B	125	80	22,23	3,75	10	112100108

11212A -11212B

dischi lamellari con tela abrasiva allo zirconio
supporto in plastica e lamella singola

Esecuzione piana
TOP LINE
EN 13743



	Ø mm	P	F mm	€		
11212A	115	40	22,23	3,85	10	112120004
11212A	115	60	22,23	3,85	10	112120006
11212A	115	80	22,23	3,85	10	112120008
11212A	115	120	22,23	3,85	10	112120012

	Ø mm	P	F mm	€		
11212B	125	40	22,23	4,75	10	112120104
11212B	125	60	22,23	4,75	10	112120106
11212B	125	80	22,23	4,75	10	112120108

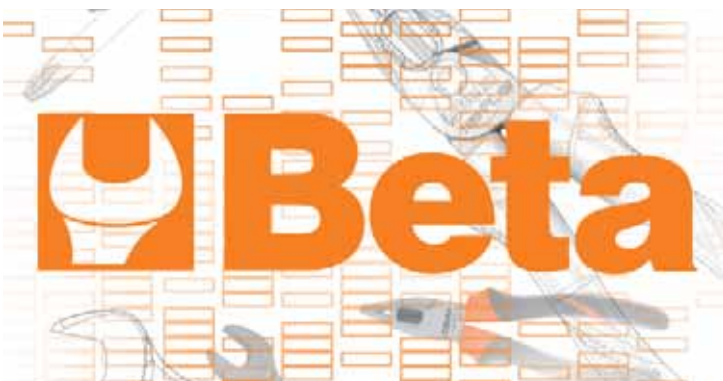

11214A÷11214C

dischi lamellari con tela abrasiva allo zirconio
supporto in plastica e lamella doppia

Esecuzione piana
TOP LINE
EN 13743

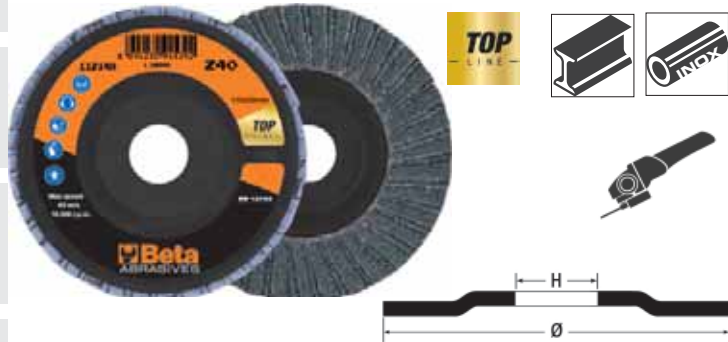

	Ø mm	P	F mm	€	📦	🖨️
11214A	115	40	22,23	3,85	10	112140004
11214A	115	60	22,23	3,85	10	112140006
11214A	115	80	22,23	3,85	10	112140008
11214A	115	120	22,23	3,85	10	112140012

	Ø mm	P	F mm	€	📦	🖨️
11214B	125	40	22,23	4,75	10	112140104
11214B	125	60	22,23	4,75	10	112140106
11214B	125	80	22,23	4,75	10	112140108

	Ø mm	P	F mm	€	📦	🖨️
11214C	180	40	22,23	9,70	10	112140204
11214C	180	60	22,23	9,70	10	112140206

11216A-11216B

dischi lamellari con tela abrasiva allo zirconio
supporto in fibra di vetro e lamella singola

Esecuzione piana
TOP LINE
EN 13743



	Ø mm	P	F mm	€	📦	🖨️
11216A	115	40	22,23	3,85	10	112160004
11216A	115	60	22,23	3,85	10	112160006
11216A	115	80	22,23	3,85	10	112160008
11216A	115	120	22,23	3,85	10	112160012

	Ø mm	P	F mm	€	📦	🖨️
11216B	125	40	22,23	4,75	10	112160104
11216B	125	60	22,23	4,75	10	112160106
11216B	125	80	22,23	4,75	10	112160108

11218A-11218B

dischi lamellari con tela abrasiva allo zirconio
supporto in fibra di vetro e lamella doppia

Esecuzione piana
TOP LINE
EN 13743



	Ø mm	P	F mm	€	📦	🖨️
11218A	115	40	22,23	3,85	10	112180004
11218A	115	60	22,23	3,85	10	112180006

	Ø mm	P	F mm	€	📦	🖨️
11218B	125	40	22,23	4,75	10	112180104
11218B	125	60	22,23	4,75	10	112180106

11220A-11220B

dischi lamellari con tela abrasiva allo zirconio
supporto in fibra di vetro e lamella singola

Esecuzione conica
TOP LINE
EN 13743



	Ø mm	P	F mm	€	📦	🖨️
11220A	115	40	22,23	3,85	10	112200004
11220A	115	60	22,23	3,85	10	112200006
11220A	115	80	22,23	3,85	10	112200008
11220A	115	120	22,23	3,85	10	112200012

	Ø mm	P	F mm	€	📦	🖨️
11220B	125	40	22,23	4,75	10	112200104
11220B	125	60	22,23	4,75	10	112200106
11220B	125	80	22,23	4,75	10	112200108

11222B

dischi lamellari con tela abrasiva allo zirconio
supporto in fibra di vetro e lamella doppia

Esecuzione conica
TOP LINE
EN 13743



	Ø mm	P	F mm	€		
11222B	125	40	22,23	4,75	10	112220104
11222B	125	60	22,23	4,75	10	112220106
11222B	125	80	22,23	4,75	10	112220108

11230A-11230B

dischi lamellari con tela abrasiva al corindone
supporto in plastica e lamella singola

Esecuzione piana
PREMIUM LINE
EN 13743



	Ø mm	P	F mm	€		
11230A	115	40	22,23	2,86	10	112300004
11230A	115	60	22,23	2,86	10	112300006
11230A	115	80	22,23	2,86	10	112300008
11230A	115	120	22,23	2,86	10	112300012

	Ø mm	P	F mm	€		
11230B	125	40	22,23	3,50	10	112300104
11230B	125	60	22,23	3,50	10	112300106

Beta

11232A

dischi lamellari con tela abrasiva al corindone
supporto in plastica e lamella doppia

Esecuzione piana
PREMIUM LINE
EN 13743



	Ø mm	P	F mm	€		
11232A	115	40	22,23	2,86	10	112320004
11232A	115	60	22,23	2,86	10	112320006
11232A	115	80	22,23	2,86	10	112320008
11232A	115	120	22,23	2,86	10	112320012

11234A

dischi lamellari con tela abrasiva al corindone
supporto in fibra di vetro e lamella singola

Esecuzione piana
TOP LINE
EN 13743



	Ø mm	P	F mm	€		
11234A	115	40	22,23	3,40	10	112340004
11234A	115	60	22,23	3,40	10	112340006
11234A	115	80	22,23	3,40	10	112340008
11234A	115	120	22,23	3,40	10	112340012

Beta

11240A-11240B

dischi lamellari con tela abrasiva allo zirconio ceramicato
supporto in plastica e lamella singola

Esecuzione piana
TOP LINE
EN 13743

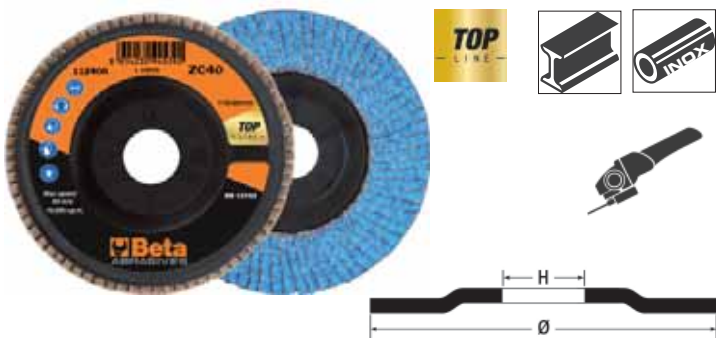

	Ø mm	P	F mm	€	10
11240A	115	40	22,23	5,40	10 112400004
11240A	115	60	22,23	5,40	10 112400006

	Ø mm	P	F mm	€	10
11240B	125	40	22,23	6,50	10 112400104
11240B	125	60	22,23	6,50	10 112400106

11242A-11242B

dischi lamellari con tela abrasiva allo zirconio ceramicato
supporto in fibra di vetro e lamella singola

Esecuzione piana
TOP LINE
EN 13743

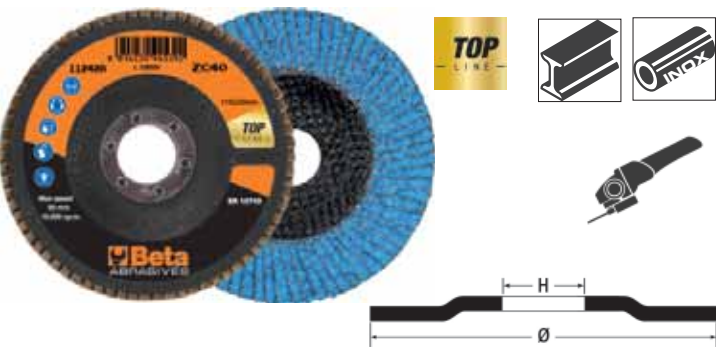

	Ø mm	P	F mm	€	10
11242A	115	40	22,23	5,40	10 112420004
11242A	115	60	22,23	5,40	10 112420006

	Ø mm	P	F mm	€	10
11242B	125	40	22,23	6,50	10 112420104
11242B	125	60	22,23	6,50	10 112420106

11246A

dischi lamellari con tela abrasiva ceramicata
supporto in plastica e lamella singola

Esecuzione piana
TOP LINE
EN 13743



	Ø mm	P	F mm	€	10
11246A	115	40	22,23	6,60	10 112460004
11246A	115	60	22,23	6,60	10 112460006

11248A-11248B

dischi lamellari con tela abrasiva ceramicata
supporto in fibra di vetro e lamella singola

Esecuzione piana
TOP LINE
EN 13743



	Ø mm	P	F mm	€	10
11248A	115	40	22,23	6,60	10 112480004
11248A	115	60	22,23	6,60	10 112480006

	Ø mm	P	F mm	€	10
11248B	125	40	22,23	8,60	10 112480104
11248B	125	60	22,23	8,60	10 112480106

11259

dischi lamellari con lamelle in feltro
supporto in fibra di vetro e lamella singola

Esecuzione piana
TOP LINE



	Ø mm	F mm	€	10
11259	115	22,23	10,80	10 112590115
11259	125	22,23	12,40	10 112590125



11260÷11268

ruote a lamelle con gambo
lamelle in tela abrasiva al corindone

EN 13743



	Ø mm	h mm	S mm	P	€		
11260	10	10	3	60	5,40	10	112600010
11260	15	15	3	60	4,30	10	112600015

	Ø mm	h mm	S mm	P	€		
11263	30	10	6	60	2,86	10	112630006
11263	30	15	6	60	2,86	10	112630016
11263	30	15	6	80	2,86	10	112630018
11263	30	20	6	40	2,86	10	112630024
11263	30	20	6	60	2,97	10	112630026
11263	30	20	6	80	2,97	10	112630028
11263	30	20	6	120	2,97	10	112630032

	Ø mm	h mm	S mm	P	€		
11264	40	15	6	60	3,10	10	112640006
11264	40	15	6	80	3,10	10	112640008
11264	40	15	6	120	3,10	10	112640012
11264	40	20	6	40	3,20	10	112640014
11264	40	20	6	60	3,20	10	112640016
11264	40	30	6	40	3,65	10	112640024
11264	40	30	6	60	3,65	10	112640026

	Ø mm	h mm	S mm	P	€		
11265	50	20	6	60	3,75	10	112650006
11265	50	20	6	80	3,75	10	112650008
11265	50	30	6	40	4,20	10	112650014
11265	50	30	6	60	4,20	10	112650016
11265	50	30	6	80	4,20	10	112650018
11265	50	30	6	120	4,40	10	112650022

	Ø mm	h mm	S mm	P	€		
11266	60	20	6	40	4,40	10	112660004
11266	60	20	6	60	4,40	10	112660006
11266	60	30	6	40	4,95	10	112660014
11266	60	30	6	60	4,95	10	112660016
11266	60	30	6	80	4,95	10	112660018
11266	60	30	6	120	5,40	10	112660022
11266	60	40	6	60	5,70	10	112660026
11266	60	40	6	80	5,70	10	112660028

	Ø mm	h mm	S mm	P	€		
11268	80	30	6	60	6,80	10	112680006
11268	80	30	6	80	6,80	10	112680008

Beta

11271A÷11271C

ruote in tessuto non tessuto abrasivo con gambo
tessuto in fibre sintetiche al corindone

gambo Ø 6 mm



	Ø mm	h mm	S mm	P	€		
11271A	40	20	6	C	7,15	10	112710001
11271A	40	20	6	M	7,15	10	112710002
11271A	40	20	6	F	7,15	10	112710003
11271A	40	20	6	VF	7,15	10	112710004

	Ø mm	h mm	S mm	P	€		
11271B	60	30	6	C	8,05	10	112710011
11271B	60	30	6	M	8,05	10	112710012
11271B	60	30	6	F	8,05	10	112710013
11271B	60	30	6	VF	8,05	10	112710014

	Ø mm	h mm	S mm	P	€		
11271C	80	50	6	C	8,90	10	112710021
11271C	80	50	6	M	8,90	10	112710022
11271C	80	50	6	F	8,90	10	112710023
11271C	80	50	6	VF	8,90	10	112710024

11276A÷11276C

ruote miste lamelle/tessuto non tessuto con gambo
lamelle in tela abrasiva alternata a tessuto in fibre sintetiche al corindone

gambo Ø 6 mm



	Ø mm	h mm	S mm	P	€		
11276A	40	20	6	M/60	8,15	10	112760006
11276A	40	20	6	M/80	8,15	10	112760008
11276A	40	20	6	M/120	8,15	10	112760012

	Ø mm	h mm	S mm	P	€		
11276B	60	30	6	M/60	8,90	10	112760016
11276B	60	30	6	M/80	8,90	10	112760018
11276B	60	30	6	M/120	8,90	10	112760022

	Ø mm	h mm	S mm	P	€		
11276C	80	50	6	M/60	10,70	10	112760036
11276C	80	50	6	M/80	10,70	10	112760038
11276C	80	50	6	M/120	10,70	10	112760042

Beta

11300A=11300G

ruote lamellari con tela al corindone con foro

EN 13743

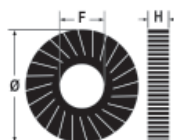

	Ø mm	H mm	P	F mm	€		
11300A	165	30	40	54	29,50	3	113000004
11300A	165	30	60	54	31,00	3	113000006
11300A	165	30	80	54	32,00	3	113000008
11300A	165	30	120	54	35,00	3	113000012
11300A	165	30	180	54	36,50	3	113000018
11300A	165	30	220	54	38,50	3	113000022

	Ø mm	H mm	P	F mm	€		
11300B	165	50	40	54	40,50	2	113000104
11300B	165	50	60	54	43,00	2	113000106
11300B	165	50	80	54	44,00	2	113000108
11300B	165	50	120	54	48,50	2	113000112
11300B	165	50	180	54	54,00	2	113000118
11300B	165	50	220	54	57,00	2	113000122

	Ø mm	H mm	P	F mm	€		
11300C	200	30	40	54	35,00	3	113000204
11300C	200	30	60	54	37,50	3	113000206
11300C	200	30	80	54	40,50	3	113000208
11300C	200	30	120	54	43,00	3	113000212
11300C	200	30	180	54	46,00	3	113000218

	Ø mm	H mm	P	F mm	€		
11300D	200	50	40	54	48,50	2	113000304
11300D	200	50	60	54	54,00	2	113000306
11300D	200	50	80	54	57,00	2	113000308
11300D	200	50	120	54	62,50	2	113000312
11300D	200	50	180	54	68,00	2	113000318
11300D	200	50	220	54	73,50	2	113000322

	Ø mm	H mm	P	F mm	€		
11300E	250	30	40	100	62,50	3	113000404
11300E	250	30	60	100	66,00	3	113000406
11300E	250	30	80	100	68,00	3	113000408
11300E	250	30	120	100	72,50	3	113000412

	Ø mm	H mm	P	F mm	€		
11300F	250	50	40	100	90,00	2	113000504
11300F	250	50	60	100	92,50	2	113000506
11300F	250	50	80	100	94,50	2	113000508
11300F	250	50	120	100	98,00	2	113000512
11300F	250	50	180	100	115,50	2	113000518
11300F	250	50	220	100	126,50	2	113000522

	Ø mm	H mm	P	F mm	€		
11300G	300	50	40	100	121,00	2	113000604
11300G	300	50	60	100	126,50	2	113000606
11300G	300	50	80	100	130,00	2	113000608

11320

ruote in tessuto non tessuto abrasivo con foro
tessuto in fibre sintetiche al corindone

Ø 200 x 50 mm



	Ø mm	H mm	P	F mm	€		
11320	200	50	C	76,2	36,50	2	113200006
11320	200	50	M	76,2	36,50	2	113200008
11320	200	50	F	76,2	36,50	2	113200012
11320	200	50	VF	76,2	36,50	2	113200024

11411

ruote lamellari con tela al corindone per satinatrici

Ø 100 x 100 mm

EN 13743

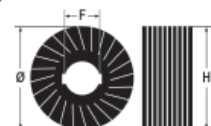

	Ø mm	H mm	P	F mm	€		
11411	100	100	40	19,1	31,00	2	114110004
11411	100	100	60	19,1	34,00	2	114110006
11411	100	100	80	19,1	35,00	2	114110008
11411	100	100	120	19,1	36,50	2	114110012
11411	100	100	240	19,1	37,50	2	114110024

11415B

ruote in tessuto non tessuto
fibre sintetiche al corindone per satinatrici

Ø 100 x 100 mm



	Ø mm	H mm	P	F mm	€		
11415B	100	100	C	19,1	26,50	2	114150106
11415B	100	100	M	19,1	26,50	2	114150108
11415B	100	100	F	19,1	26,50	2	114150112
11415B	100	100	VF	19,1	26,50	2	114150124

11420B

ruote miste lamelle/tessuto non tessuto per satinatrici
tela abrasiva alternata a fibre sintetiche al corindone

Ø 100 x 100 mm

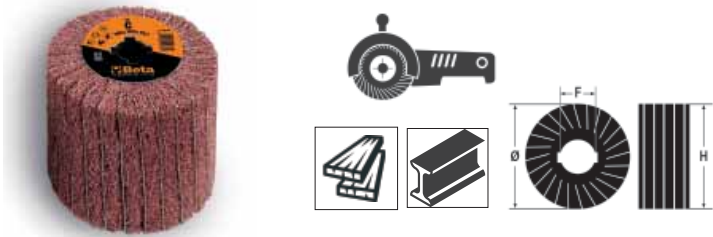

	Ø mm	H mm	P	F mm	€		
11420B	100	100	C/60	19,1	28,50	2	114200106
11420B	100	100	M/80	19,1	28,50	2	114200108
11420B	100	100	F/120	19,1	28,50	2	114200112
11420B	100	100	VF/240	19,1	28,50	2	114200124

11431

dischi radiali in tessuto non tessuto
fibre sintetiche al corindone

Ø 115 mm



	Ø mm	P	F mm	€		
11431	115	C	22,23	16,50	4	114310006
11431	115	M	22,23	16,50	4	114310008
11431	115	F	22,23	16,50	4	114310012
11431	115	VF	22,23	16,50	4	114310024

11440A÷11440C

dischi fibrati con tela allo zirconio

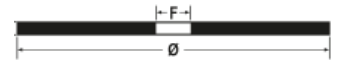

	Ø mm	P	F mm	€		
11440A	115	24	22	1,43	25	114400024
11440A	115	36	22	1,43	25	114400036
11440A	115	60	22	1,32	25	114400060
11440A	115	120	22	1,32	25	114400120

	Ø mm	P	F mm	€		
11440B	125	24	22	1,65	25	114400224
11440B	125	36	22	1,65	25	114400236
11440B	125	60	22	1,54	25	114400260
11440B	125	120	22	1,54	25	114400320

	Ø mm	P	F mm	€		
11440C	180	24	22	2,64	25	114400424
11440C	180	36	22	2,64	25	114400436
11440C	180	60	22	2,53	25	114400460
11440C	180	120	22	2,53	25	114400520

11450A÷11450C

dischi fibrati con tela al corindone

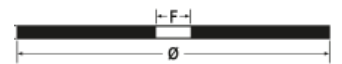

	Ø mm	P	F mm	€		
11450A	115	24	22	1,10	25	114500024
11450A	115	36	22	1,10	25	114500036
11450A	115	60	22	0,99	25	114500060
11450A	115	120	22	0,99	25	114500120

	Ø mm	P	F mm	€		
11450B	125	24	22	1,21	25	114500224
11450B	125	36	22	1,21	25	114500236
11450B	125	60	22	1,21	25	114500260
11450B	125	120	22	1,21	25	114500320

	Ø mm	P	F mm	€		
11450C	180	24	22	1,87	25	114500424
11450C	180	36	22	1,87	25	114500436
11450C	180	60	22	1,76	25	114500460
11450C	180	120	22	1,76	25	114500520

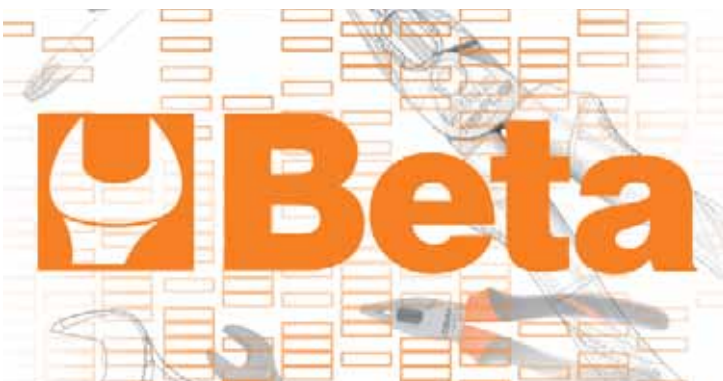

11488PF

plattrelli di fissaggio per dischi fibrati con ghiera M14



	∅ mm	€		
11488P	115	8,35	1	114880115
11488P	125	9,15	1	114880125
11488P	180	14,00	1	114880180

11491-11493-11495

rotoli antispreco in tela abrasiva al corindone



	H mm	L m	P	€		
11491	38	50	40	54,00	1	114910004
11491	38	50	60	53,00	1	114910006
11491	38	50	80	51,50	1	114910008
11491	38	50	100	50,50	1	114910010
11491	38	50	120	50,50	1	114910012
11491	38	50	150	50,50	1	114910015
11491	38	50	180	50,50	1	114910018
11491	38	50	220	50,50	1	114910022
11491	38	50	240	50,50	1	114910024
11491	38	50	320	50,50	1	114910032
11491	38	50	400	50,50	1	114910040

	H mm	L m	P	€		
11493	50	50	40	86,00	1	114930004
11493	50	50	60	78,00	1	114930006
11493	50	50	80	77,00	1	114930008
11493	50	50	100	72,50	1	114930010
11493	50	50	120	72,50	1	114930012
11493	50	50	150	72,50	1	114930015
11493	50	50	180	72,50	1	114930018
11493	50	50	220	72,50	1	114930022
11493	50	50	240	72,50	1	114930024
11493	50	50	320	72,50	1	114930032
11493	50	50	400	72,50	1	114930040

	H mm	L m	P	€		
11495	120	25	40	101,00	1	114950004
11495	120	25	60	98,50	1	114950006
11495	120	25	80	95,50	1	114950008
11495	120	25	100	93,50	1	114950010
11495	120	25	120	93,50	1	114950012
11495	120	25	180	93,50	1	114950018
11495	120	25	240	93,50	1	114950024
11495	120	25	400	93,50	1	114950040

11498

rotolo antispreco in tessuto non tessuto fibre sintetiche al corindone

h 100 mm x 10 m



	H mm	L m	P	€		
11498	100	10	M	45,00	1	114980008
11498	100	10	F	36,50	1	114980012
11498	100	10	VF	36,50	1	114980015
* 11498	100	10	UF	39,50	1	114980018

*Carburo di silicio



PINZE PER CAPICORDA E CAPICORDA

Codice		Capicorda	Matrice	Range (mm ²)	Utilizzo
1601/PC					Per capicorda telefonia e trasmissione dati 4P/6P/8P
1602				0,75-6	Per capicorda preisolati modello leggero
1602A				0-6	Per capicorda preisolati modello standard
1603				1,25-5,5	Per capicorda non isolati modello leggero
1603A				0-8	Per capicorda non isolati chiusi modello standard
1603B				0-8	Per capicorda non isolati aperti modello standard
1606/2				0,14-10	A grande effetto per capicorda a tubetto
1606A				0,5-6 6-16	Per capicorda a tubetto
1606T				0,1-10	Per capicorda a tubetto, crimpatura su 4 lati
1607				6,48 5,41 1,69	A grande effetto per connettori BNC per cavi coassiali RG 58, RG 59, RG 62, RG 71
1608				0,5-6	Per capicorda preisolati, con regolatore di pressione
1608A				0,75-6	A grande effetto per capicorda preisolati
1609				0,5-2,5	Per capicorda non isolati
1609A				0,5-6	A grande effetto per capicorda non isolati
1609B				10-120	Per capicorda non isolati



1601/PC

pinza a cricchetto per capicorda telefonia e trasmissione dati

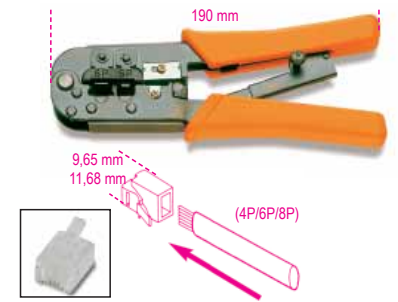

RJ11-RJ12-RJ45

€ 68,50

2 016010011

1602

pinza per capicorda preisolati modello leggero

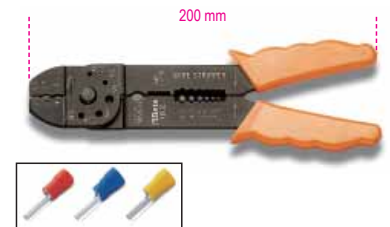

mm²
0,75-6

€ 17,10

5 016020001

1602/C9

pinza per capicorda 1602 con assortimento di 450 capicorda



1602/C9

€ 147,50

1 016020045

1602

BM00180	R/6,3	50	n.
BM00280	B/6,3	50	1
BM00380	G/6,3	50	
BM00191	R/6,3	50	
BM00291	B/6,3	50	
BM00392	G/6,3	50	
BM00160	R/1,6	50	
BM00260	B/2,3	50	
BM00360	G/3,6	50	

420x185x60 mm - 1,5 kg

1602A

pinza per capicorda preisolati
modello standard

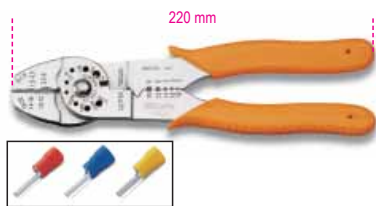

mm²
0÷6 € 62,50 2 016020005

1603

pinza per capicorda
non isolati modello leggero

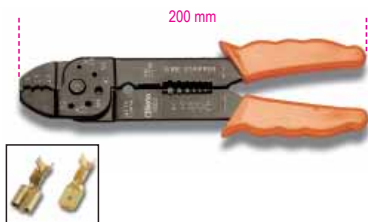

mm²
1,25÷5,5 € 17,10 5 016030001

1603A

pinza per capicorda non isolati chiusi
modello standard

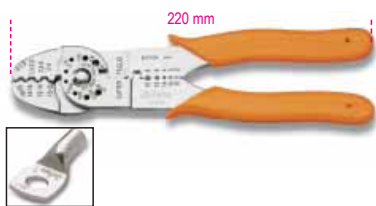

mm²
0÷8 € 62,50 2 016030005

1603B

pinza per capicorda non isolati aperti
modello standard

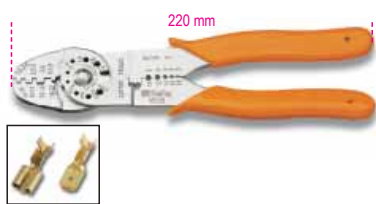

mm²
0÷8 € 64,00 2 016030010



1606/2

pinza a grande effetto
per capicorda a tubetto



mm²
0,14÷10 L 175 A 65 B 20 € 374,00 1 016060002

1606A

pinza per capicorda a tubetto



mm²
1606A6 0,5÷6 € 100,50 1 016060010
1606A16 6÷16 € 100,50 1 016060016

1606A/C9

Pinza per capicorda a tubetto 1606A6
con assortimento di 450 capicorda



1606A/C9 € 163,50 1 016060045

Model	Wire Size	Quantity
1606A6		1
BM00601	W/0,5	50
BM00604	N/1,5	100
BM00506	B/2,5	100
BM00508	G/4	100
BM00610	Y/6	100

420x185x60 mm - 2,5 kg



Beta

1606T

pinza per capicorda a tubetto,
crimpatura su 4 lati

minore sforzo alla leva



mm²
0,1÷10 L 173 A 61 B 13 € 334,00 1 016060005

1607

pinza a grande effetto per connettori BNC
per cavi coassiali RG 58, RG 59, RG 62,
RG 71



1607 L 220 A 73 B 19 € 329,00 1 016070001

1608

pinza per capicorda preisolati,
con regolatore di pressione

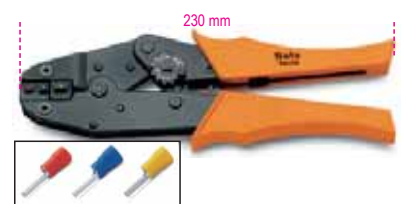

mm²
0,5÷6 € 128,50 1 016080001

1608/C9

pinza per capicorda 1608
con assortimento di 450 capicorda



1608/C9 € 259,00 1 016080045

1608		n.
BM00180	R/6,3	50
BM00280	B/6,3	50
BM00380	G/6,3	50
BM00191	R/6,3	50
BM00291	B/6,3	50
BM00392	G/6,3	50
BM00160	R/1,6	50
BM00260	B/2,3	50
BM00360	G/3,6	50

420x185x60 mm - 2 kg

1608A

pinza a grande effetto
per capicorda preisolati



mm² 0,75÷6 € 260,00 1 016080005

Beta

1609

pinza per capicorda non isolati



mm² 0,5÷2,5 € 128,50 1 016090001

1609A

pinza a grande effetto
per capicorda non isolati



mm² 0,5÷6 € 505,00 1 016090005

1609B

pinza per capicorda non isolati



L mm 600 mm² 10÷120 € 342,00 1 016090101

1609C/C5

pinza oleodinamica per capicorda

crimpature esagonali



mm² 50÷240 € 2.190,00 1 016090210
500x300x110 mm - 4 kg

1609M

coppia di matrici per 1609C

crimpature esagonali



	mm ²	€		
1609M/16	10-16	79,00	1	016090221
1609M/35	25-35	79,00	1	016090223
1609M/70	50-70	79,00	1	016090225
1609M/120	95-120	79,00	1	016090227
1609M/150	150	79,00	1	016090229
1609M/185	185	79,00	1	016090231
1609M/240	240	79,00	1	016090233

1639S

sonda tirafili in nylon

con teste intercambiabili



L m 10 Ø mm 4 € 22,10 1 016390010



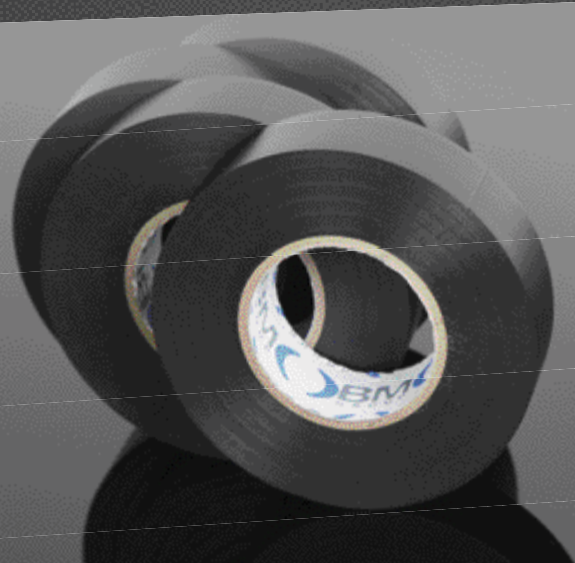
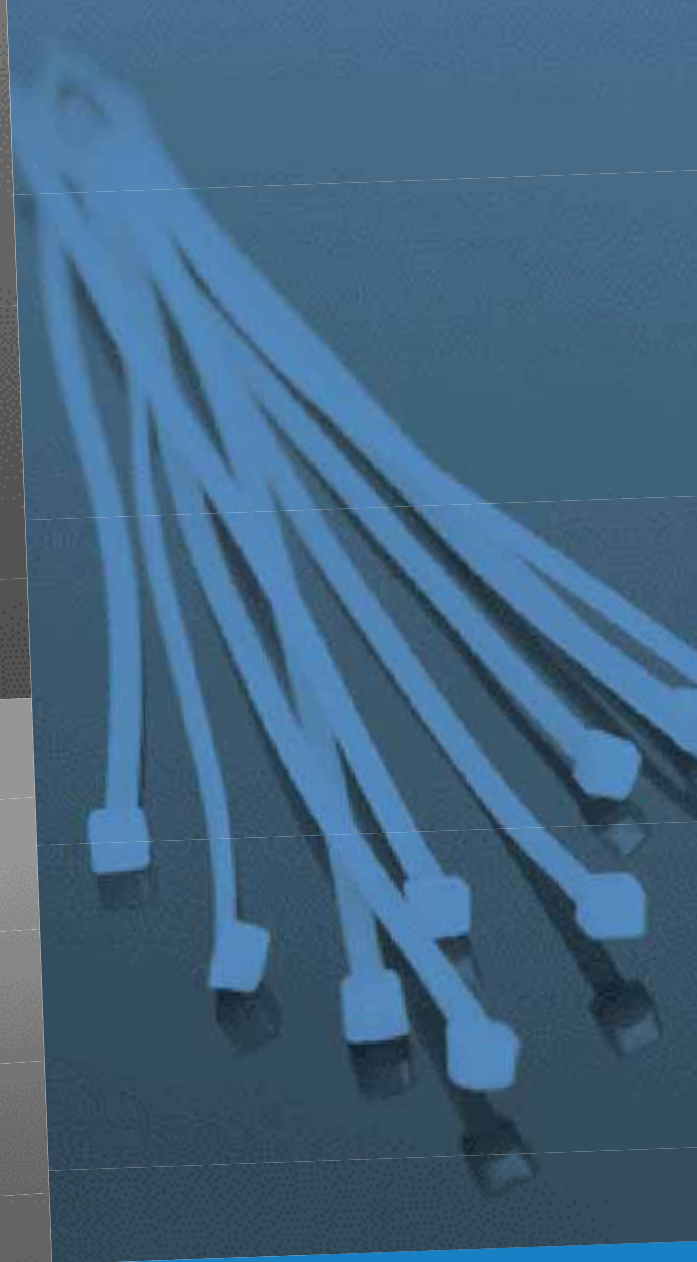
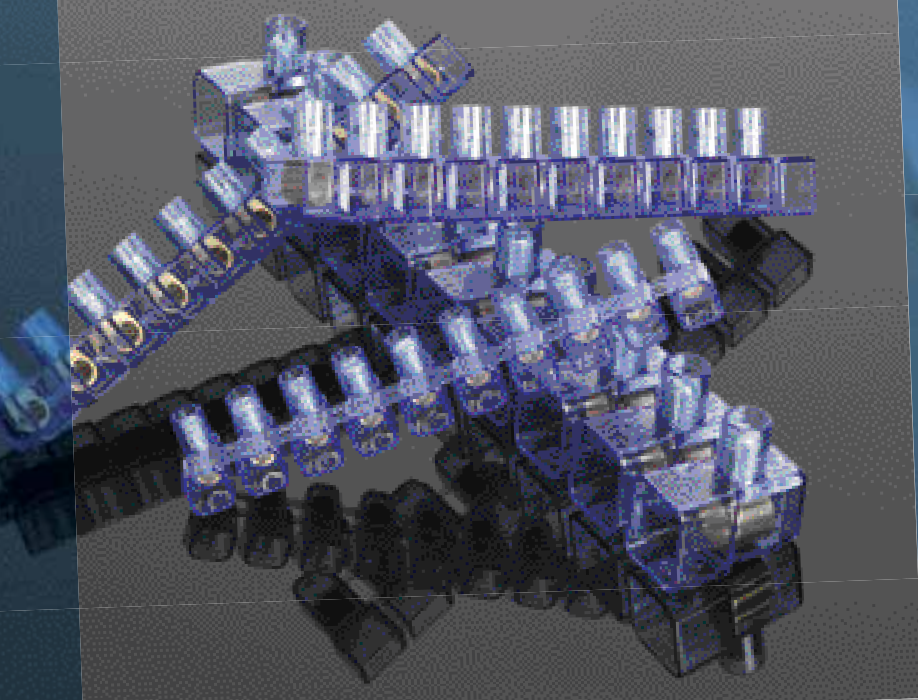

PRODOTTI A MARCHIO BM: TERMINALI, MORSETTIERE, FASCETTE, NASTRI ISOLANTI

BM Group progetta, produce e distribuisce elementi di connessione e prodotti per l'installazione elettrica, dal 1958. Qualità, sicurezza e affidabilità sono da sempre i valori di BM, quei valori che, insieme alla passione per l'eccellenza, hanno portato l'azienda a diventare, passo dopo passo, il punto di riferimento nel mercato del materiale elettrico. Dal 2018 BM Group è parte di Beta Utensili. Un'accurata selezione di prodotti a marchio BM è presentata in questa sezione, ad integrazione della gamma Beta.

QUALITÀ CERTIFICATA





1610-B terminali preisolati ad occhio



D mm	mm ²	L mm	€	100 pz	BM00
4	0,25-1,5	20,6	8,50	100	BM00119
5	0,25-1,5	21,8	8,40	100	BM00125
5	1,5-2,5	22,4	8,55	100	BM00225
6	1,5-2,5	26	9,60	100	BM00231
8	1,5-2,5	29,8	11,40	100	BM00237
6	4-6	29,1	15,00	50	BM00331
8	4-6	34,5	18,50	50	BM00337

- indicare nell'ordine il numero di terminali e non di confezioni
- i prezzi indicati sono relativi a 100 pezzi

1614-P terminali preisolati a puntale



D mm	mm ²	L mm	€	100 pz	BM00
1,9	0,25-1,5	19	8,50	100	BM00151
1,9	1,5-2,5	19	8,90	100	BM00251
2,7	4-6	28	14,80	50	BM00350

- indicare nell'ordine il numero di terminali e non di confezioni
- i prezzi indicati sono relativi a 100 pezzi

1616-SM terminali preisolati a spina maschio

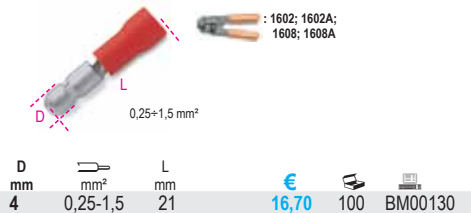

D mm	mm ²	L mm	€	100 pz	BM00
4	0,25-1,5	21	16,70	100	BM00130

- indicare nell'ordine il numero di terminali e non di confezioni
- i prezzi indicati sono relativi a 100 pezzi

1618-SF terminali preisolati a spina femmina



D mm	mm ²	L mm	€	100 pz	BM00
3,8	0,25-1,5	23,5	19,40	100	BM00140

- indicare nell'ordine il numero di terminali e non di confezioni
- i prezzi indicati sono relativi a 100 pezzi

1620-M terminali preisolati rapidi maschio

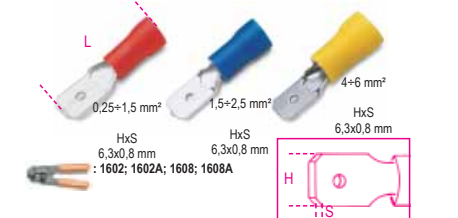

HxS mm	mm ²	L mm	€	100 pz	BM00
6,3x0,8	0,25-1,5	21	16,10	100	BM00180
6,3x0,8	1,5-2,5	21	16,70	100	BM00280
6,3x0,8	4-6	24,5	18,30	50	BM00380

- indicare nell'ordine il numero di terminali e non di confezioni
- i prezzi indicati sono relativi a 100 pezzi

1622-F terminali preisolati rapidi femmina

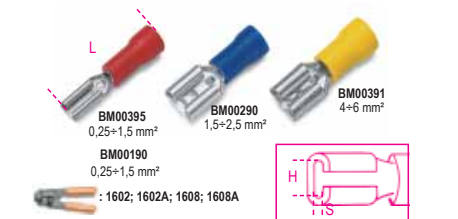

HxS mm	mm ²	L mm	€	100 pz	BM00
6,3x0,8	0,25-1,5	20,7	16,40	100	BM00190
2,8x0,5	0,25-1,5	18,5	13,80	100	BM00395
6,3x0,8	1,5-2,5	20,7	16,70	100	BM00290
6,3x0,8	4-6	24,5	23,70	50	BM00391

- indicare nell'ordine il numero di terminali e non di confezioni
- i prezzi indicati sono relativi a 100 pezzi

1624-FI terminali rapidi femmina isolati



HxS mm	mm ²	L mm	€	100 pz	BM00
6,3x0,8	0,25-1,5	22	18,10	100	BM00191
6,3x0,8	1,5-2,5	22	18,40	50	BM00291
6,3x0,8	4-6	25	23,00	50	BM00392

- indicare nell'ordine il numero di terminali e non di confezioni
- i prezzi indicati sono relativi a 100 pezzi

1628-C connettori di linea preisolati



D mm	mm ²	L mm	€	100 pz	BM00
1,8	0,25-1,5	25	13,60	100	BM00160
2,5	1,5-2,5	26,5	16,10	100	BM00260
3,7	4-6	27	22,30	50	BM00360

- indicare nell'ordine il numero di terminali e non di confezioni
- i prezzi indicati sono relativi a 100 pezzi

1630-CR connettori rapidi



mm ²	L mm	€	500 pz	BM00
0,25-1	15,3	14,10	500	BM00110
1,25-2,5	15,9	13,70	500	BM00210

- indicare nell'ordine il numero di terminali e non di confezioni
- i prezzi indicati sono relativi a 100 pezzi

1632-TS terminali a tubetto singoli



mm ²	L mm	€	500 pz	BM00
0,5	14	1,68	500	BM00601
0,75	14	1,68	500	BM00602
1	14	1,68	500	BM00603
1,5	14	1,68	500	BM00604
2,5	14	2,20	250	BM00506
4	17	3,50	200	BM00508
6	20	5,65	100	BM00610
0,5	14	1,61	500	BM00501
0,75	14	1,61	500	BM00502
1	14	1,61	500	BM00503
1,5	14	1,60	500	BM00504
6	20	5,40	100	BM00510

- indicare nell'ordine il numero di terminali e non di confezioni
- i prezzi indicati sono relativi a 100 pezzi

1634-TD terminali a tubetto doppi



mm ²	L mm	€	200 pz	BM00
2x0,5	15	5,55	200	BM00651
2x0,75	15	4,30	200	BM00652
2x1	15	4,30	200	BM00654
2x1,5	16	4,65	200	BM00656
2x2,5	18,5	5,25	100	BM00558
2x4	23	15,60	100	BM00560
2x6	26	20,40	50	BM00661
2X0,5	15	4,15	200	BM00551
2X0,75	15	4,15	200	BM00552
2X1	15	4,15	200	BM00554
2X1,5	16	4,40	200	BM00556
2X6	26	19,40	50	BM00561

- indicare nell'ordine il numero di terminali e non di confezioni
- i prezzi indicati sono relativi a 100 pezzi





1635-D

morsetti multipli in polipropilene, barrette da 12 poli
 Corpo isolante: polipropilene (PP) naturale
 Corpo conduttivo: ottone

Vite imperdibile: acciaio zincato
 Autoestinguenza: EN 60335-1: 2002+A2:2006 (par. 30.2.3), EN 60695-2-10 a 850°C, EN 60695-2-11
 Temperatura d'esercizio: max 85°C
 Grado di protezione: IP20
 Norme di riferimento: EN 60998-1: 2004, EN 60998-2-1: 2004, EN 60335-1: 2002 + A2: 2006 (par. 30.2.3), IEC/EN 60695-2-11

CE



mm²	L mm	L1 mm	mm²	€		
16	93,7	14,7	2,5	1,43	50	BM9200
20,5	116,5	17,2	4	1,77	50	BM9201
23,5	139,5	20,1	6	2,58	50	BM9202
25,3	175,5	22,5	16	4,55	25	BM9203
35,2	228	33,5	25	12,50	10	BM9204

1635-S

morsetti di coda per connessioni volanti, barrette da 10 poli

Corpo isolante: policarbonato trasparente UL94 V0
 Corpo conduttivo: ottone
 Vite imperdibile: acciaio zincato
 Autoestinguenza: EN60695-2-10 a 850°C, EN 60335-1:2002 +A2:2006, EN60695-2-11
 Temperatura d'esercizio: max 85°C
 Grado di protezione: IP20
 Norme di riferimento: EN60998-1: EN60998-2-1:2004

CE



mm²	L mm	L1 mm	S mm	mm²	N	€		
1.5	15	7.5	14.5	1.5	2	1,29	10	BM991
					1 2+3 0.75 2+4			
2.5	17.5	9	18.2	2.5	2	1,32	10	BM992
					1.5 2+3 1 2+4			
4	21	10.3	20	4	2	1,77	10	BM9924
					2.5 2+3 1.5 2+4			
6	22.5	11.8	23	6	2	2,06	10	BM993
					4 2+3 2.5 2+4			
10	26	14.7	26	10	2	3,50	10	BM994
					6 2+3 4 2+4			
16	31.8	18.8	32.2	16	2	8,30	10	BM995
					10 2+3 6 2+4			

i prezzi si riferiscono alla singola barretta

1635-S

CE



mm²	L mm	L1 mm	S mm	mm²	N	€		
25	36.3	22.5	41.9	25	2	3,85	25	BM9960
					16 2+3 10 2+4			
35	43.5	26.1	49.4	35	2	4,95	25	BM9961
					25 2+3 16 2+4			



1748-BV2

fascette in nylon, colore naturale

Materiale: Poliammide PA 6.6
 Classe di autoestinguenza: UL 94-V2
 Temperatura di esercizio: -40°C ÷ +85°C
 Temperatura minima d'installazione: -10°C
 Resistenza agli agenti chimici: Buona resistenza alle basi, agli olii, ai grassi, ai solventi di cloruro. Limitata resistenza agli acidi. Non resistente ai fenoli
 Norme di riferimento: EN 62275:2015-02
 Classificazione: tipo 1 (EN); tipo 21 (UL)

CE



A mm	L mm	Ø MAX mm	F MAX N	€		
2.5	80	14	80	1,41	100	BMB0824
2.5	100	20.5	80	1,31	100	BMB1025
2.5	120	27	80	2,30	100	BMB1225
2.5	160	40	80	3,10	100	BMB1625
2.5	200	52.5	80	3,40	100	BMB2025
3.6	140	33	180	3,50	100	BMB1436
3.6	200	52.5	180	4,80	100	BMB2036
3.6	300	106	180	6,75	100	BMB2936
3.6	370	105	180	10,70	100	BMB3736
4.6	120	24	220	4,70	100	BMB1248
4.6	160	36	220	5,00	100	BMB1648
4.8	188	46	220	6,00	100	BMB1948
4.8	200	50	220	5,90	100	BMB2048
4.8	250	65	220	8,55	100	BMB2548
4.8	300	81	220	8,75	100	BMB3048
4.8	370	103.5	220	11,10	100	BMB3748
4.8	390	110	220	15,10	100	BMB3948
4.8	430	122.5	220	19,50	100	BMB4348
4.8	530	160	220	32,50	100	BMB5348
7.6	150	24	550	16,10	100	BMB1576
7.6	200	51	550	16,60	100	BMB2076
7.6	300	83	550	18,50	100	BMB2976
7.6	370	103.5	550	22,40	100	BMB3776
7.6	450	130.5	550	38,00	100	BMB4576
7.6	540	159	550	49,00	100	BMB5476
7.6	750	226	550	78,00	100	BMB7576
8.8	550	163.5	800	46,00	100	BMB5390
8.8	710	195	800	65,00	100	BMB7190
8.8	780	235.5	800	72,50	100	BMB7890
9.0	430	130.5	800	38,50	100	BMB4390
9.0	810	245	800	86,50	100	BMB8190
9.0	1020	295	800	119,00	100	BMB1090
9.0	1220	375.5	800	154,50	100	BMB1290
9.0	1530	460	800	211,00	100	BMB1590

- indicare nell'ordine il numero di fascette e non di confezioni
 - i prezzi indicati sono relativi a 100 pezzi



1748V

fascette in nylon, colore verde

Materiale: Poliammide PA 6.6
 Classe di autoestinguenza: UL 94-V2
 Temperatura di esercizio: -40°C ÷ +85°C
 Temperatura minima d'installazione: -10°C
 Resistenza agli agenti chimici: Buona resistenza alle basi, agli olii, ai grassi, ai solventi di cloruro. Limitata resistenza agli acidi. Non resistente ai fenoli
 Norme di riferimento: EN 62275:2015-02
 Classificazione: tipo 1 (EN); tipo 21 (UL)

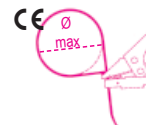

A mm	L mm	Ø MAX mm	F MAX N	€		
2.5	100	20.5	80	1,29	100	BMV1025
3.6	140	33	180	3,15	100	BMV1436
4.8	200	50	220	5,35	100	BMV2048
4.8	300	81	220	7,95	100	BMV3048

- indicare nell'ordine il numero di fascette e non di confezioni
 - i prezzi indicati sono relativi a 100 pezzi

1748N

fascette in nylon, colore nero

UV resistant

Materiale: Poliammide PA 6.6 + carbon black
 Classe di autoestinguenza: UL 94-V2
 Temperatura di esercizio: -40°C ÷ +85°C
 Temperatura minima d'installazione: -10°C
 Resistenza agli agenti chimici: Buona resistenza alle basi, agli olii, ai grassi, ai solventi di cloruro. Limitata resistenza agli acidi. Non resistente ai fenoli
 Norme di riferimento: EN 62275:2015-02
 Classificazione: tipo 1 (EN)

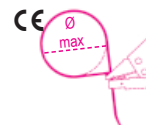

A mm	L mm	Ø mm	F MAX N	€		
2.5	80	14	80	1,41	100	BMN0824
2.5	100	20.5	80	1,31	100	BMN1025
2.5	120	27	80	2,33	100	BMN1225
2.5	160	40	80	3,10	100	BMN1625
2.5	200	52.5	80	3,40	100	BMN2025
3.6	140	33	180	3,50	100	BMN1436
3.6	200	52.5	180	4,80	100	BMN2036
3.6	300	106	180	6,75	100	BMN2936
3.6	370	105	180	10,90	100	BMN3736
4.6	120	24	220	4,70	100	BMN1248
4.6	160	36	220	5,10	100	BMN1648
4.8	188	46	220	6,05	100	BMN1948
4.8	200	50	220	5,90	100	BMN2048
4.8	250	65	220	8,55	100	BMN2548
4.8	300	81	220	8,75	100	BMN3048
4.8	370	103.5	220	11,10	100	BMN3748
4.8	390	110	220	15,10	100	BMN3948
4.8	430	122.5	220	19,50	100	BMN4348
4.8	530	160	220	32,50	100	BMN5348
7.6	150	24	550	16,10	100	BMN1576
7.6	200	51	550	16,60	100	BMN2076
7.6	300	83	550	18,50	100	BMN2976
7.6	370	103.5	550	22,00	100	BMN3776
7.6	450	130.5	550	38,00	100	BMN4576
7.6	540	159	550	49,00	100	BMN5476
7.6	750	226	550	78,00	100	BMN7576
8.8	550	163.5	800	46,00	100	BMN5390
8.8	710	195	800	65,00	100	BMN7190
8.8	780	235.5	800	72,50	100	BMN7890
9.0	430	130.5	800	38,50	100	BMN4390
9.0	810	245	800	86,00	100	BMN8190
9.0	1020	295	800	119,50	100	BMN1090
9.0	1220	375.5	800	154,50	100	BMN1290
9.0	1530	460	800	211,00	100	BMN1590

- indicare nell'ordine il numero di fascette e non di confezioni
 - i prezzi indicati sono relativi a 100 pezzi

1748-UL

fascette in nylon, per carichi pesanti,
colore nero
UV and IMPACT resistant

Materiale: Poliammide PA 6.6 + carbon black
Classe di autoestinguenza: UL 94-V2
Temperatura di esercizio: -40°C ÷ +85°C
Temperatura minima d'installazione: -10°C
Resistenza agli agenti chimici: Buona resistenza alle basi, agli olii, ai grassi, ai solventi di cloruro. Limitata resistenza agli acidi. Non resistente ai fenoli
Norme di riferimento: EN 62275:2015-02
Classificazione: tipo 1 (EN); tipo 21 (UL)

CE

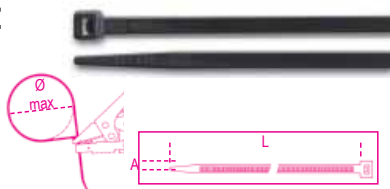

A mm	L mm	Ø MAX mm	F MAX N	€	📦	🖨️
12.4	230	57	1200	47,50	100	BMN2412
12.4	480	136.5	1200	82,00	100	BMN4912
12.4	730	216.1	1200	114,00	100	BMN7412
12.4	880	263.9	1200	136,50	100	BMN8912
12.4	1000	305	1200	163,00	100	BMN1012

- indicare nell'ordine il numero di fascette e non di confezioni
- i prezzi indicati sono relativi a 100 pezzi

1748-N2D

fascette in nylon,
colore nero
UV resistant

Materiale: Poliammide PA 6.6 + carbon black
Classe di autoestinguenza: UL 94-V2
Temperatura di esercizio: -40°C ÷ +85°C
Temperatura minima d'installazione: -10°C
Resistenza agli agenti chimici: Buona resistenza alle basi, agli olii, ai grassi, ai solventi di cloruro. Limitata resistenza agli acidi. Non resistente ai fenoli
Norme di riferimento: EN 62275:2015-02
Classificazione: tipo 1 (EN)

CE

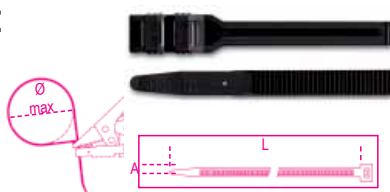

A mm	L mm	Ø MAX mm	F MAX N	€	📦	🖨️
9.0	180	40	400	24,70	100	BMN1890
9.0	265	62	540	38,50	100	BMN2690
9.0	360	93	540	46,50	100	BMN3690

- indicare nell'ordine il numero di fascette e non di confezioni
- i prezzi indicati sono relativi a 100 pezzi



1748-BV0

fascette in nylon autoestinguenza,
colore bianco

Materiale: Poliammide PA 6.6
Classe di autoestinguenza: UL 94-V0
Temperatura di esercizio: -40°C ÷ +85°C
Temperatura minima d'installazione: -10°C
Resistenza agli agenti chimici: Buona resistenza alle basi, agli olii, ai grassi, ai solventi di cloruro. Limitata resistenza agli acidi. Non resistente ai fenoli
Norme di riferimento: EN 62275:2015-02
Classificazione: tipo 1 (EN)

CE V0

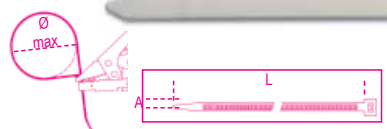

A mm	L mm	Ø MAX mm	F MAX N	€	📦	🖨️
2.5	100	20.5	80	2,05	100	BMB1025V0
3.6	150	36.0	180	4,95	100	BMB1536V0
3.6	200	52.5	180	7,10	100	BMB2036V0
4.8	200	49.5	230	7,75	100	BMB2048V0
4.8	300	81.0	230	11,30	100	BMB3048V0
4.8	370	106.7	230	16,20	100	BMB3848V0
7.6	370	106.7	540	28,50	100	BMB3876V0

- indicare nell'ordine il numero di fascette e non di confezioni
- i prezzi indicati sono relativi a 100 pezzi

1748-BX

fascette in nylon,
colore blu,
rilevabile da metal detector

Materiale: Poliammide PA 6.6 + polvere metallica
Classe di autoestinguenza: UL 94-V2
Temperatura di esercizio: -40°C ÷ +85°C
Temperatura minima d'installazione: -10°C
Resistenza agli agenti chimici: Buona resistenza alle basi, agli olii, ai grassi, ai solventi di cloruro. Limitata resistenza agli acidi. Non resistente ai fenoli
Norme di riferimento: EN 62275:2015-02
Classificazione: tipo 1 (EN)

CE

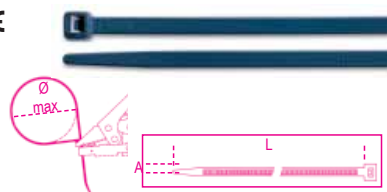

A mm	L mm	Ø MAX mm	F MAX N	€	📦	🖨️
2.5	100	20.5	80	2,46	100	BMBX1025
3.6	150	36.0	180	6,45	100	BMBX1536
3.6	200	52.5	180	8,70	100	BMBX2036
4.8	200	49.5	230	10,60	100	BMBX2048
4.8	300	81.0	230	15,40	100	BMBX3048
4.8	370	106.7	230	20,90	100	BMBX3848
7.6	370	106.7	540	38,00	100	BMBX3876

- indicare nell'ordine il numero di fascette e non di confezioni
- i prezzi indicati sono relativi a 100 pezzi

1748-BL

fascette in nylon con dente in acciaio,
colore naturale

Materiale: Poliammide PA 6.6 + acciaio
Classe di autoestinguenza: UL 94-V2
Temperatura di esercizio: -40°C ÷ +85°C
Temperatura minima d'installazione: -10°C
Resistenza agli agenti chimici: Buona resistenza alle basi, agli olii, ai grassi, ai solventi di cloruro. Limitata resistenza agli acidi. Non resistente ai fenoli
Norme di riferimento: EN 62275:2015-02
Classificazione: tipo 1 (EN)

CE

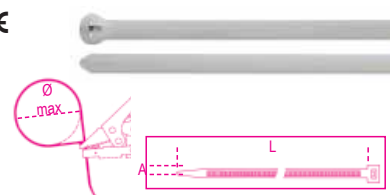

A mm	L mm	Ø MAX mm	F MAX N	€	📦	🖨️
2.5	100	20.5	180	4,90	100	BMBL1025
2.5	200	52.5	180	6,40	100	BMBL2025
3.6	140	33.0	250	11,00	100	BMBL1436
4.8	200	49.5	360	15,30	100	BMBL2048
4.8	300	81.0	360	19,60	100	BMBL3048
4.8	370	103.5	360	23,50	100	BMBL3748
7.6	370	103.5	780	44,50	100	BMBL3776

- indicare nell'ordine il numero di fascette e non di confezioni
- i prezzi indicati sono relativi a 100 pezzi

1748-NL

fascette in nylon con dente in acciaio,
colore nero,
UV resistant

Materiale: Poliammide PA 6.6 + acciaio + carbon black
Classe di autoestinguenza: UL 94-V2
Temperatura di esercizio: -40°C ÷ +85°C
Temperatura minima d'installazione: -10°C
Resistenza agli agenti chimici: Buona resistenza alle basi, agli olii, ai grassi, ai solventi di cloruro. Limitata resistenza agli acidi. Non resistente ai fenoli
Norme di riferimento: EN 62275:2015-02
Classificazione: tipo 1 (EN)

CE

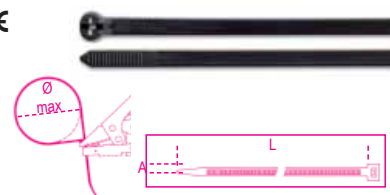

A mm	L mm	Ø MAX mm	F MAX N	€	📦	🖨️
2.5	100	20.5	180	4,90	100	BMNL1025
2.5	200	52.5	180	6,40	100	BMNL2025
3.6	140	33.0	250	11,00	100	BMNL1436
4.8	200	49.5	360	15,30	100	BMNL2048
4.8	300	81.0	360	19,60	100	BMNL3048
4.8	370	103.5	360	23,50	100	BMNL3748
7.6	370	103.5	780	43,50	100	BMNL3776

- indicare nell'ordine il numero di fascette e non di confezioni
- i prezzi indicati sono relativi a 100 pezzi



1748-BR

fascette in nylon **riutilizzabili**, colore naturale

Materiale: Poliammide PA 6.6
Classe di autoestinguenza: UL 94-V2
Temperatura di esercizio: -40°C ÷ +85°C
Temperatura minima d'installazione: -10°C
Resistenza agli agenti chimici: Buona resistenza alle basi, agli olii, ai grassi, ai solventi di cloruro. Limitata resistenza agli acidi. Non resistente ai fenoli
Norme di riferimento: EN 62275:2015-02
Classificazione: tipo 1 (EN); tipo 21 (UL)

CE

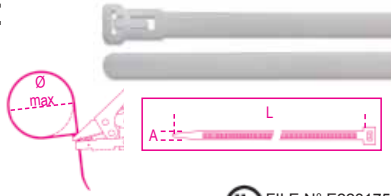

FILE N° E223175

A	L	Ø MAX	F MAX	€	100	BMBR
mm	mm	mm	N			
7.6	150	40	230	16,90	100	BMBR1576
7.6	200	55	230	18,10	100	BMBR2076
7.6	300	82	230	30,50	100	BMBR3076

- indicare nell'ordine il numero di fascette e non di confezioni
- i prezzi indicati sono relativi a 100 pezzi

1748-BH

fascette in nylon **con occhiello**, colore naturale

Materiale: Poliammide PA 6.6
Classe di autoestinguenza: UL 94-V2
Temperatura di esercizio: -40°C ÷ +85°C
Temperatura minima d'installazione: -10°C
Resistenza agli agenti chimici: Buona resistenza alle basi, agli olii, ai grassi, ai solventi di cloruro. Limitata resistenza agli acidi. Non resistente ai fenoli
Norme di riferimento: EN 62275:2015-02
Classificazione: tipo 1 (EN); tipo 21 (UL)

CE



FILE N° E223175

A	L	Ø MAX	F MAX	€	100	BMBH
mm	mm	mm	N			
2.5	110	19.0	80	4,50	100	BMBH1125
* 4.8	200	49.8	230	11,10	100	BMBH2048
* 7.6	305	78.7	550	36,50	100	BMBH3076

- indicare nell'ordine il numero di fascette e non di confezioni
- i prezzi indicati sono relativi a 100 pezzi

1748-BP

fascette in nylon **ad inserzione**, colore naturale

Materiale: Poliammide PA 6.6
Classe di autoestinguenza: UL 94-V2
Temperatura di esercizio: -40°C ÷ +85°C
Temperatura minima d'installazione: -10°C
Resistenza agli agenti chimici: Buona resistenza alle basi, agli olii, ai grassi, ai solventi di cloruro. Limitata resistenza agli acidi. Non resistente ai fenoli
Norme di riferimento: EN 62275:2015-02
Classificazione: tipo 1 (EN); tipo 21 (UL)

CE



FILE N° E223175

A	L	Ø MAX	F MAX	€	100	BMBP
mm	mm	mm	N			
3.6	155	37.9	180	6,85	100	BMBP1536
* 4.8	200	50.8	230	11,90	100	BMBP2048

- indicare nell'ordine il numero di fascette e non di confezioni
- i prezzi indicati sono relativi a 100 pezzi

1748-BT

fascette in nylon con targhetta trasversale 25x8mm, colore naturale

Materiale: Poliammide PA 6.6
Classe di autoestinguenza: UL 94-V2
Temperatura di esercizio: -40°C ÷ +85°C
Temperatura minima d'installazione: -10°C
Resistenza agli agenti chimici: Buona resistenza alle basi, agli olii, ai grassi, ai solventi di cloruro. Limitata resistenza agli acidi. Non resistente ai fenoli
Norme di riferimento: EN 62275:2015-02
Classificazione: tipo 1 (EN); tipo 21 (UL)

CE

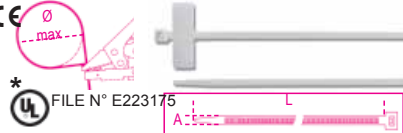

FILE N° E223175

A	L	Ø MAX	F MAX	€	100	BMBT
mm	mm	mm	N			
* 2.5	100	22.0	80	7,70	100	BMBT1025
2.5	200	53.5	80	12,10	100	BMBT22025

- indicare nell'ordine il numero di fascette e non di confezioni
- i prezzi indicati sono relativi a 100 pezzi

1748-BT2

fascette in nylon con targhetta longitudinale 13x27mm, colore naturale

Materiale: Poliammide PA 6.6
Classe di autoestinguenza: UL 94-V2
Temperatura di esercizio: -40°C ÷ +85°C
Temperatura minima d'installazione: -10°C
Resistenza agli agenti chimici: Buona resistenza alle basi, agli olii, ai grassi, ai solventi di cloruro. Limitata resistenza agli acidi. Non resistente ai fenoli
Norme di riferimento: EN 62275:2015-02
Classificazione: tipo 1 (EN)

CE



A	L	Ø MAX	F MAX	€	100	BMBT
mm	mm	mm	N			
4.8	190	51	230	14,30	100	BMBT12248

- indicare nell'ordine il numero di fascette e non di confezioni
- i prezzi indicati sono relativi a 100 pezzi

1748-BT3

fascette in nylon con targhetta esterna 20x9mm, colore naturale

Materiale: Poliammide PA 6.6
Classe di autoestinguenza: UL 94-V2
Temperatura di esercizio: -40°C ÷ +85°C
Temperatura minima d'installazione: -10°C
Resistenza agli agenti chimici: Buona resistenza alle basi, agli olii, ai grassi, ai solventi di cloruro. Limitata resistenza agli acidi. Non resistente ai fenoli
Norme di riferimento: EN 62275:2015-02
Classificazione: tipo 1 (EN)

CE

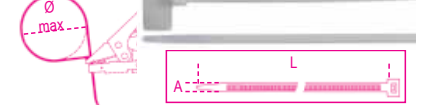

A	L	Ø MAX	F MAX	€	100	BMBT
mm	mm	mm	N			
2.5	110	22	80	7,85	100	BMBT11125

- indicare nell'ordine il numero di fascette e non di confezioni
- i prezzi indicati sono relativi a 100 pezzi

1748-BA1

basette di fissaggio

Materiale: Poliammide PA 6.6
Classe di autoestinguenza: UL 94-V2
Temperatura di esercizio: -40°C ÷ +85°C
Temperatura minima d'installazione: -10°C
Resistenza agli agenti chimici: Buona resistenza alle basi, agli olii, ai grassi, ai solventi di cloruro. Limitata resistenza agli acidi. Non resistente ai fenoli



SxDxH	Ø	F	€	100	BMB
mm	mm	mm			
15.2x9.4x6.8	3.3	3.6	10,70	100	BMB0905
22x16.2x10.8	5.2	9	24,20	100	BMB0906

- indicare nell'ordine il numero di basette e non di confezioni
- i prezzi indicati sono relativi a 100 pezzi

1748-NA1

basette di fissaggio

Materiale: Poliammide PA 6.6
Classe di autoestinguenza: UL 94-V2
Temperatura di esercizio: -40°C ÷ +85°C
Temperatura minima d'installazione: -10°C
Resistenza agli agenti chimici: Buona resistenza alle basi, agli olii, ai grassi, ai solventi di cloruro. Limitata resistenza agli acidi. Non resistente ai fenoli



SxDxH	Ø	F	€	100	BMN
mm	mm	mm			
15.2x9.4x6.8	3.3	3.6	11,00	100	BMN0905
22x16.2x10.8	5.2	9	19,60	100	BMN0906

- indicare nell'ordine il numero di basette e non di confezioni
- i prezzi indicati sono relativi a 100 pezzi



1748-BA2

basette di fissaggio bidirezionali

Materiale: Poliammide PA 6.6

Classe di autoestinguenza: UL 94-V2

Temperatura di esercizio: -40°C ÷ +85°C

Temperatura minima d'installazione: -10°C

Resistenza agli agenti chimici: Buona resistenza alle basi, agli olii, ai gras-si, ai solventi di cloruro. Limitata resistenza agli acidi. Non resistente ai fenoli

CE

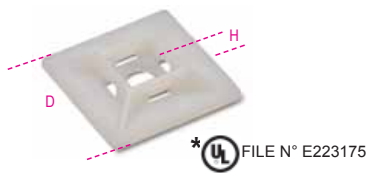

SxDxH mm	F mm	€		
19x19x5.4	3.6	13,30	100	BMB0901
* 28x28x7	4.8	18,40	100	BMB0902
* 28x28x5.8	4.8	16,80	100	BMB0903

- indicare nell'ordine il numero di basette e non di confezioni

- i prezzi indicati sono relativi a 100 pezzi

1748-NA2

basette di fissaggio bidirezionali

UV resistant

Materiale: Poliammide PA 6.6

Classe di autoestinguenza: UL 94-V2

Temperatura di esercizio: -40°C ÷ +85°C

Temperatura minima d'installazione: -10°C

Resistenza agli agenti chimici: Buona resistenza alle basi, agli olii, ai gras-si, ai solventi di cloruro. Limitata resistenza agli acidi. Non resistente ai fenoli

CE



SxDxH mm	F mm	€		
19x19x5.4	3.6	13,30	100	BMN0901
* 28x28x7	4.8	18,40	100	BMN0902
* 28x28x5.8	4.8	16,70	100	BMN0903

- indicare nell'ordine il numero di basette e non di confezioni

- i prezzi indicati sono relativi a 100 pezzi



1748-S

fascette autobloccanti in acciaio inossidabile

Materiale: acciaio inox AISI 304

Dispositivo di fissaggio: a sfera

Classe di autoestinguenza: non infiammabile

Plenum rating: AH-1

Resistenza ai raggi UV: eccellente

Temperatura di esercizio: -60°C ÷ +300°C

Temperatura minima d'installazione: -60°C

Resistenza agli agenti chimici: eccellente

Norme di riferimento: EN 62275:2015-02

Classificazione: tipo 2 (EN); tipo 2 (UL)

CE

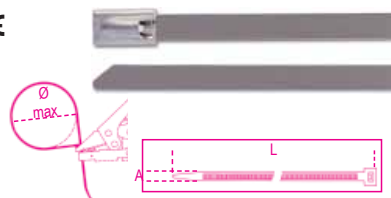

A mm	L mm	ØMAX mm	Trazione N	€		
4.6	125	38	890	81,00	100	BMS1345
4.6	200	61.9	890	84,00	100	BMS2045
7.9	200	61.9	1500	89,00	100	BMS2079
4.6	290	90.6	890	90,50	100	BMS3045
7.9	300	90.6	1500	103,00	100	BMS3079
4.6	360	112.8	890	98,50	100	BMS3745
7.9	360	112.8	1500	112,00	100	BMS3779
7.9	500	163.8	1500	133,00	100	BMS5079
4.6	520	163.8	890	98,50	100	BMS5245
4.6	680	214.8	890	104,50	100	BMS6845
7.9	680	214.8	1500	151,50	100	BMS6879
4.6	840	265.7	890	109,50	100	BMS8445
7.9	840	265.7	1500	179,50	100	BMS8479

- indicare nell'ordine il numero di fascette e non di confezioni

- i prezzi indicati sono relativi a 100 pezzi

1748-SC

fascette autobloccanti in acciaio inossidabile ,
rivestimento in poliestere nero

Materiale: acciaio inox AISI 304 + poliestere

Dispositivo di fissaggio: a sfera

Classe di autoestinguenza: non infiammabile

Plenum rating: AH-1

Resistenza ai raggi UV: eccellente

Temperatura di esercizio: -60°C ÷ +300°C

Temperatura minima d'installazione: -60°C

Resistenza agli agenti chimici: eccellente

Norme di riferimento: EN 62275:2015-02

Classificazione: tipo 2 (EN); tipo 2 (UL)

CE

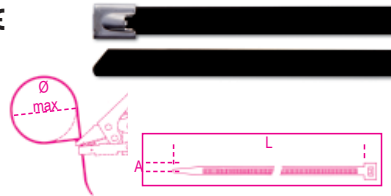

A mm	L mm	ØMAX mm	Trazione N	€		
4.6	125	38	450	84,00	100	BMSC1345
4.6	200	61.9	450	98,00	100	BMSC2045
7.9	200	61.9	800	99,50	100	BMSC2079
4.6	290	90.6	450	109,50	100	BMSC3045
7.9	300	90.6	800	117,00	100	BMSC3079
4.6	360	112.8	450	121,00	100	BMSC3745
7.9	360	112.8	800	132,00	100	BMSC3779
7.9	520	163.8	800	165,50	100	BMSC5079
4.6	520	163.8	450	122,50	100	BMSC5245
4.6	680	214.8	450	139,50	100	BMSC6845
7.9	680	214.8	800	188,50	100	BMSC6879
4.6	840	265.7	450	148,50	100	BMSC8445
7.9	840	265.7	800	226,50	100	BMSC8479

- indicare nell'ordine il numero di fascette e non di confezioni

- i prezzi indicati sono relativi a 100 pezzi

1748-BV

fascette in velcro, riapribili a strappo
colore bianco

Materiale: polietilene-poliamide (PE-PA)

Temperatura di esercizio: da -20°C a +60°C



A mm	L mm	Ø MAX mm	F MAX N	€		
12,7	229	55	180	237,00	10	BMBV2312
19	229	55	220	272,00	10	BMBV2319

- indicare nell'ordine il numero di fascette e non di confezioni

- i prezzi indicati sono relativi a 100 pezzi

1748-NV

fascette in velcro, riapribili a strappo
colore nero

Materiale: polietilene-poliamide (PE-PA)

Temperatura di esercizio: da -20°C a +60°C



A mm	L mm	Ø MAX mm	F MAX N	€		
12,7	229	55	180	237,50	10	BMNV2312

- indicare nell'ordine il numero di fascette e non di confezioni

- i prezzi indicati sono relativi a 100 pezzi

1743

pinza per fascette in Nylon

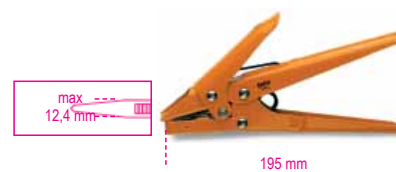

1743	€ 58,00		1	017430001
------	---------	--	---	-----------

1743T

pinza tagliafascette

• Adatta anche per il taglio di piccoli cavi
(3x1.5mm²; 1x17mm²)



1743T	€ 34,50		1	017430100
-------	---------	--	---	-----------



1748-N

pinze per fascette in nylon con larghezza da 2.5 a 4.8 mm

Taglio automatico al raggiungimento della tensione impostata.
Dotata di regolazione della tensione di serraggio

Materiale: struttura in polimero e fibra di vetro, parti interne in metallo



BM1100 € 64,50 1 BM1100

1748-ST

pinze automatiche per fascette in acciaio inossidabile,
per fascette con larghezza fino a 7,9mm e spessore fino a 0,35mm.

Taglio automatico al raggiungimento della tensione impostata.
Tensione di serraggio regolabile su 4 livelli

Materiale: in metallo con struttura in alluminio



BM1105 € 248,50 1 BM1105

1638M

guaine termorestringenti basso spessore, in minibox

Rapporto di restringimento: 2:1

Materiale: polietilene

Temperatura di esercizio: da -55°C a +125°C max

Temperatura di restringimento: da +70°C a +125°C

VRMS massima: 600 V

Grado di autoestinguenza della guaina: VW-1 (UL 224)

Privo di alogeni



L	Ø1	Ø2	€		
mm	m	mm	mm		
1,6	12	1,6	0,8	18,90	1 BMGBS016MNE
2,4	11	2,4	1,2	18,90	1 BMGBS024MNE
3,2	11	3,2	1,6	18,90	1 BMGBS032MNE
4,8	10	4,8	2,4	18,90	1 BMGBS048MNE
6,4	9	6,4	3,2	18,90	1 BMGBS064MNE
9,5	7	9,5	4,8	18,90	1 BMGBS095MNE
12,7	6	12,7	6,4	18,90	1 BMGBS127MNE
19	5	19,1	9,5	19,30	1 BMGBS190MNE
25,4	3,5	25,4	12,7	19,70	1 BMGBS254MNE

1639ESB

nastri isolanti in PVC

Temperatura d'esercizio: 0-90°C

Carico di rottura: 28N/cm equivalente a 18.6 N/mm²

Allungamento a rottura: 200%

Adesione all'acciaio: 2.2N/cm

Adesione al dorso: 2 N/cm

Rigidità dielettrica: 45kV/mm

Infiammabilità: ritardante la fiamma

Norme di riferimento: IEC 60454-2

Classificazione: CEI EN 60454-3-1-5/F-PVCP/90



S	A	L	€		
mm	mm	m			
0.15	15	10	0,87	10	BMESB1510BI
0.15	15	10	0,87	10	BMESB1510BL
0.15	15	10	0,87	10	BMESB1510GI
0.15	15	10	0,87	10	BMESB1510GR
0.15	15	10	0,97	10	BMESB1510GV
0.15	15	10	0,87	10	BMESB1510MA
0.15	15	10	0,87	10	BMESB1510NE
0.15	15	10	0,87	10	BMESB1510RO
0.15	15	10	0,87	10	BMESB1510VE
0.15	15	25	2,12	10	BMESB1525BI
0.15	15	25	2,12	10	BMESB1525BL
0.15	15	25	2,12	10	BMESB1525GI
0.15	15	25	2,12	10	BMESB1525GR
0.15	15	25	2,22	10	BMESB1525GV
0.15	15	25	2,12	10	BMESB1525MA
0.15	15	25	2,12	10	BMESB1525NE
0.15	15	25	2,12	10	BMESB1525RO
0.15	15	25	2,12	10	BMESB1525VE
0.15	19	25	2,32	10	BMESB1925BI
0.15	19	25	2,32	10	BMESB1925BL
0.15	19	25	2,32	10	BMESB1925GI
0.15	19	25	2,32	10	BMESB1925GR
0.15	19	25	2,41	10	BMESB1925GV
0.15	19	25	2,32	10	BMESB1925MA
0.15	19	25	2,32	10	BMESB1925NE
0.15	19	25	2,32	10	BMESB1925RO
0.15	19	25	2,32	10	BMESB1925VE
0.15	25	25	3,30	8	BMESB2525BI
0.15	25	25	3,30	8	BMESB2525BL
0.15	25	25	3,30	8	BMESB2525GI
0.15	25	25	3,30	8	BMESB2525GR
0.15	25	25	3,40	8	BMESB2525GV
0.15	25	25	3,30	8	BMESB2525MA
0.15	25	25	3,30	8	BMESB2525NE
0.15	25	25	3,30	8	BMESB2525RO
0.15	25	25	3,30	8	BMESB2525VE
0.15	50	25	5,00	4	BMESB5025NE

I prezzi si riferiscono al singolo nastro

1639ESC

nastri isolanti in PVC

Temperatura d'esercizio: 0-80°C

Carico di rottura: 28N/cm equivalente a 18.6 N/mm²

Allungamento a rottura: 200%

Adesione all'acciaio: 2.2N/cm

Adesione al dorso: 2.2 N/cm

Rigidità dielettrica: 38kV/mm

Infiammabilità: ritardante la fiamma

Norme di riferimento: ASTM-D-1000 ; UL510

Classificazione: CEI EN 60454-3-1-5/F-PVCP/90



S mm 0.18 A mm 19 L m 20 € 3,10 10 BMESC1920NE

I prezzi si riferiscono al singolo nastro

1639ETA

nastri isolanti in PVC per temperature estreme

Temperatura d'esercizio: -18 ÷ +105°C

Carico di rottura: 35N/cm equivalente a 19.4 N/mm²

Allungamento a rottura: 300%

Adesione all'acciaio: 3.1N/cm

Adesione al dorso: 2.7 N/cm

Rigidità dielettrica: 55.5kV/mm

Infiammabilità: ritardante la fiamma

Norme di riferimento: ASTM-D-1000 ; UL510

Classificazione: CEI EN 60454-3-1-5/F-PVCP/90



S mm 0.18 A mm 19 L m 20 € 9,25 1 BMETA1920NE

1639EAB

nastri isolanti autoagglomeranti a base di EPR

Temperatura d'esercizio: -40 ÷ +90°C

Carico di rottura: 2.4 N/mm²

Allungamento a rottura: 750%

Rigidità dielettrica: 29.5kV/mm

Infiammabilità: ritardante la fiamma

Norme di riferimento: ASTM-D-4388; ASTM-D-4325

Eccellente resistenza a: umidità, corrosione e agenti chimici



S mm 0.76 A mm 19 L m 9 € 18,90 1 BMEAB1909NE





GAMMA BLISTER

Per la tua vendita
a libero servizio!

- **Efficienza espositiva**
- **Migliore visibilità**
- **Codice a barre**



SUPPORTO BLISTER:

- PVC Antistrappo
- 4 formati
- Sistema di fissaggio di nuova generazione con fascetta elastica

42K



mm	€	↕	📦
5,5x5,5	8,90	5	000429505
6x6	9,05	5	000429506
7x7	9,10	5	000429507
8x8	9,45	5	000429508
9x9	9,85	5	000429509
10x10	10,10	5	000429510
11x11	10,60	5	000429511
12x12	10,70	5	000429512
13x13	10,80	5	000429513
14x14	12,30	5	000429514
15x15	13,60	5	000429515
16x16	14,10	5	000429516
17x17	14,70	5	000429517
18x18	15,70	5	000429518
19x19	16,20	5	000429519
20x20	18,20	3	000429520
21x21	19,60	3	000429521
22x22	20,00	3	000429522
23x23	21,60	3	000429523
24x24	22,90	3	000429524
25x25	24,10	2	000429525
26x26	26,00	2	000429526
27x27	28,00	2	000429527
28x28	28,50	2	000429528
29x29	31,50	2	000429529
30x30	33,00	2	000429530
32x32	36,50	2	000429532

55K



mm	€	↕	📦
6x7	5,80	5	000559012
8x9	5,90	5	000559021
10x11	6,20	5	000559030
10x12	8,35	5	000559033
10x13	9,15	5	000559035
12x13	6,95	5	000559042
12x14	9,35	5	000559045
13x17	11,00	5	000559051
14x15	8,70	5	000559054
14x17	11,80	5	000559057
16x17	9,95	5	000559060
17x19	13,20	2	000559063
18x19	11,60	2	000559066
19x22	14,90	2	000559069
20x22	13,20	2	000559075
21x23	14,00	2	000559078
22x24	16,20	2	000559081
24x26	16,60	2	000559087
24x27	18,10	2	000559090
25x28	18,90	2	000559096
27x29	21,20	2	000559099
27x30	24,40	2	000559102
30x32	23,50	2	000559108

90K



mm	€	↕	📦
6x7	10,70	5	000909006
8x9	11,40	5	000909012
10x11	12,60	5	000909018
12x13	13,70	5	000909027
14x15	14,90	5	000909033
16x17	17,00	5	000909039
18x19	19,90	5	000909045

mm	€	↕	📦
20x22	22,70	3	000909051
21x23	25,50	2	000909057
24x26	28,50	2	000909063
24x27	31,50	2	000909067
25x28	34,50	2	000909070
27x29	37,00	2	000909073
30x32	41,50	2	000909080

93K



mm	€	↕	📦
21x22	43,00	3	000939021

94K



mm	€	↕	📦
8x10	18,50	2	000949008
9x11	19,20	2	000949009
10x11	20,10	2	000949010
11x13	20,70	2	000949011
12x14	21,90	2	000949012
13x15	21,90	2	000949013
14x15	25,50	2	000949014
14x17	26,50	2	000949015
17x19	27,00	2	000949017
19x22	28,50	2	000949019
22x24	35,50	2	000949022
24x27	38,50	2	000949024
30x32	50,00	2	000949030

96/SC9



96/SC9	€	↕	📦
1,5-2-2,5-3-4-5-6-8-10 mm	21,80	1	000960374

96/ST6K



96/ST6K	€	↕	📦
2,5-3-4-5-6-8 mm	15,40	3	000969370

96N/ST6K



96N/ST6K	€	↕	📦
2,5-3-4-5-6-8 mm	10,90	3	000969640

96BPA/SC9



96BPA/SC9	€	↕	📦
1,5-2-2,5-3-4-5-6-8-10 mm	50,00	1	000961974

96BP-CL/SC9



96BP-CL/SC9	€	↕	📦
1,5-2-2,5-3-4-5-6-8-10 mm	55,50	1	000961619

96BPC/SC9



96BPC/SC9	€	↕	📦
1,5-2-2,5-3-4-5-6-8-10 mm	45,50	1	000960354

96C/AS



	€	↕	📦
1/16	1,79	20	000961702
3/32	2,48	20	000961706
1/8	2,61	20	000961710
5/32	3,05	20	000961714
3/16	3,45	20	000961716
7/32	3,90	20	000961718
1/4	4,35	20	000961720
5/16	4,85	10	000961724
3/8	6,00	10	000961728

96LBP/SC9



96LBP/SC9 € 53,00 1 000961354
1,5-2-2,5-3-4-5-6-8-10 mm

96/BGS7



96/BGS7 € 32,50 1 000960367
1,5-2-2,5-3-4-5-6 mm

96/BG7



96/BG7 € 34,50 1 000960368
2,5-3-4-5-6-8-10 mm

96TK



mm	€		
2	12,60	5	000969934
2,5	12,60	5	000969935
3	13,20	5	000969936
4	13,60	5	000969938
5	13,90	5	000969940
6	15,90	5	000969941
8	20,10	3	000969943
10	23,10	3	000969945

97BTX/SC8



97BTX/SC8 € 81,50 1 000970164
T9-T10-T15-T20-T25-T27-T30-T40

97BTXL/SC8



97BTXL/SC8 € 94,00 1 000970364
T9-T10-T15-T20-T25-T27-T30-T40

111E



L mm	€		
100	26,00	3	001110110
150	27,00	3	001110115
200	33,00	3	001110120
250	40,00	3	001110125
300	53,00	3	001110130
380	104,00	3	001110138
450	173,00	2	001110145
600	239,50	1	001110160

111EN



L mm	€		
100	23,80	3	001110410
150	24,90	3	001110415
200	29,00	3	001110420
250	36,00	3	001110425
300	48,50	3	001110430
380	96,00	3	001110438
450	163,50	2	001110445

111ER



L mm	€		
200	34,50	3	001110520
250	42,50	3	001110525
300	55,50	2	001110530



123/K4



123/K4 € 34,50 1 001230504

142K



mm	€		
6	18,70	3	001429006
7	18,70	3	001429007
8	19,30	3	001429008
9	20,50	3	001429009
10	21,00	3	001429010
11	21,70	3	001429011
12	22,50	3	001429012
13	24,20	3	001429013
14	25,00	2	001429014
15	26,50	2	001429015
16	28,50	2	001429016
17	29,50	2	001429017
18	31,50	2	001429018
19	32,00	2	001429019
21	41,50	1	001429021
22	43,00	1	001429022
24	50,00	1	001429024

192/S2



192/S2 € 67,00 1 001920070
8x10/12x13 mm
16x17/18x19 mm

195K



mm	€		
8x10	21,30	2	001959010
12x13	24,40	2	001959013
14x15	25,50	2	001959015
16x18	30,00	2	001959018
17x19	31,50	2	001959019

374K



L mm 240 € 40,00 1 003749024

850M0



L mm	€	1	008500910
233	25,50		

855P



L1 mm	€	1	008550010
240	77,00		

860/58K



L mm	€	1	008609884
126	82,00		

860LP



SxA mm	€	5	008600005
0,5x3	2,02		
0,6x4,5	2,02		
0,8x5,5	2,02		
1x5,5	2,02		
1,2x6,5	2,02		

860PH



PH	€	5	008600220
0	2,02		
1	2,02		
2	2,02		
3	2,02		
4	2,92		

860PZ



PZ	€	5	008600320
1	2,02		
2	2,02		
3	2,02		
4	2,92		

860PE



mm	€	5	008600101
2	2,15		
2,5	2,15		
3	2,15		
4	2,15		
5	2,15		
6	2,15		
8	2,70		
10	2,70		

860TX



°	€	5	008600704
T6	2,70		
T7	2,70		
T8	2,70		
T9	2,70		
T10	2,15		
T15	2,15		
T20	2,15		
T25	2,15		
T27	2,15		
T30	2,15		
T40	2,15		

860RTX



°	€	5	008600550
T9	2,92		
T10	2,92		
T15	2,92		
T20	2,92		
T25	2,92		
T27	2,92		
T30	2,92		
T40	2,92		

860/C27

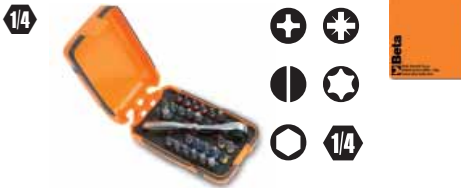

860/C27	€	1	008600880
	93,50		

860MIX/A10



860MIX/A10	€	1	008600900
	39,00		

860TX/A10



860TX/A10	€	1	008600970
	41,50		

860MIX/A31



860MIX/A31	€	1	008600902
	92,00		

862F/A7



862F/A7	€	1	008620950
	53,50		

900K



mm	€	10	009009040
4	4,45		
4,5	4,45		
5	4,45		
5,5	4,45		
6	4,45		
7	4,45		
8	4,45		
9	4,45		
10	4,45		
11	4,45		
12	4,45		
13	4,50		
14	4,60		

900/20LK



L mm	€	5	009009819
100	9,90		

900/25K



14"			
L mm	€		
41	18,30	5	009009830

900BG/30K



14"			
L mm	€		
128	9,60	5	009009834

900/55K



14"			
L mm	€		
125	49,00	5	009009870

900/55ZK



14"			
L mm	€		
125	49,00	3	009009882

900/58K



14"			
L mm	€		
126	74,50	2	009009884

910AK



3/8"			
mm	€		
6	7,10	5	009109006
7	7,10	5	009109007
8	7,10	5	009109008
9	7,10	5	009109009
10	7,10	5	009109010
11	7,10	5	009109011
12	7,30	5	009109012
13	7,30	5	009109013
14	7,30	5	009109014
15	7,30	5	009109015
16	8,20	5	009109016
17	8,20	5	009109017
18	8,20	5	009109018
19	8,20	5	009109019
20	8,80	5	009109020
21	8,80	5	009109021
22	8,90	5	009109022

910/21K



3/8"			
L mm	€		
125	12,70	5	009109822

910/25K



3/8"			
L mm	€		
54,6	22,60	5	009109830

910/55K





3/8"			
L mm	€		
200	53,00	3	009109882

910/58K



3/8"			
L mm	€		
222	81,50	1	009109884

920AK



12"			
mm	€		
10	7,15	10	009209010
11	7,15	10	009209011
12	7,15	10	009209012
13	7,40	10	009209013
14	7,40	10	009209014
15	7,40	10	009209015
16	8,35	10	009209016
17	8,35	10	009209017
18	8,35	10	009209018
19	8,35	10	009209019
20	9,10	5	009209020
21	9,10	5	009209021
22	9,10	5	009209022
23	10,60	5	009209023
24	10,60	5	009209024
25	10,60	5	009209025
26	10,80	5	009209026
27	10,80	5	009209027
28	10,80	5	009209028
29	11,30	5	009209029
30	11,30	5	009209030
32	11,80	5	009209032

920/21K



12"			
L mm	€		
125	17,20	5	009209822

920/25K



12"			
L mm	€		
75	27,00	5	009209830

920/55K



12"			
L mm	€		
275	64,50	3	009209882

920/58K





12"			
L mm	€		
281	97,00	1	009209926

935K



	€		
mm			
6x7	8,65	5	009359105
8x9	9,30	5	009359111
10x11	10,40	5	009359115
12x13	11,50	5	009359117
14x15	13,40	5	009359126
16x17	14,60	5	009359128
18x19	17,20	5	009359131
20x22	20,70	3	009359138

937K

	€		
mm			
6x6	9,30	5	009379006
7x7	9,70	5	009379007
8x8	10,10	5	009379008
9x9	10,70	5	009379009
10x10	11,00	5	009379010
11x11	11,50	5	009379011
12x12	12,90	5	009379012
13x13	13,20	5	009379013
14x14	14,40	5	009379014
15x15	15,90	5	009379015
16x16	17,10	5	009379016
17x17	17,80	5	009379017
18x18	18,20	5	009379018
19x19	18,90	5	009379019
20x20	21,20	5	009379020
21x21	23,20	3	009379021
22x22	24,40	3	009379022

943BXK



mm	€		
5,5	18,20	5	009439005
6	18,20	5	009439006
7	19,40	5	009439007
8	19,40	5	009439008
10	21,00	3	009439010
13	22,40	3	009439013

951K



mm	€		
2	20,10	5	009519521
2,5	20,10	5	009519525
3	20,10	5	009519530
3,5	20,70	5	009519535
4	20,70	5	009519540
4,5	22,70	5	009519545
5	22,70	5	009519550
6	26,00	5	009519560
8	28,00	5	009519580
10	35,50	5	009519610

1032K



L mm	€		
140x0,9	27,00	5	010329013
140x1,3	26,50	5	010329014
180	28,50	5	010329017

1033K



L mm	€		
140x0,9	30,50	5	010339013
140x1,3	29,50	5	010339014
180	31,00	5	010339017

1034K



L mm	€		
130x0,9	30,50	5	010349013
130x1,3	29,50	5	010349014
170	31,00	5	010349017

1036K



L mm	€		
140x0,9	29,00	5	010369013
140x1,3	28,50	5	010369014
175	29,50	5	010369017

1037K



L mm	€		
140x0,9	32,50	5	010379013
140x1,3	31,00	5	010379014
175	32,50	5	010379017

1038K



L mm	€		
135x0,9	32,50	5	010389013
135x1,3	31,00	5	010389014
175	32,50	5	010389017

1044NK



L mm	€		
250	31,50	5	010449025

1048NK



L mm	€		
175	34,00	3	010489910
250	36,50	5	010489915

1048VNK



L mm	€		
175	28,50	3	010489111
250	32,50	5	010489116

1052K



L mm	€		
140	29,00	3	010529014
190	32,50	3	010529019
240	35,50	3	010529024

1082K



L mm	€		
140	28,00	5	010829004
160	29,00	5	010829006

1082GK



L mm	€		
140	24,00	5	010829064
160	25,00	5	010829066

1082BMK



L mm	€		
140	35,00	3	010829034
160	38,00	3	010829036

1082GBMK



L mm	€		
140	30,50	3	010829264
160	34,50	3	010829266

1084K



L mm	€		
160	32,50	3	010849006

1084GK



L mm 160 € 28,50 5 010849066

1084BMK



L mm 160 € 39,50 3 010849036

1084GBMK



L mm 160 € 43,50 3 010849266

1088K



L mm 160 € 40,00 2 010889006

1088BMK



L mm 160 € 49,00 2 010889036

1096K



L mm 200 € 25,00 5 010969020

1098K



L mm 190 € 21,50 5 010989190
220 € 24,30 5 010989220

1098PLK



L mm 220 € 27,00 5 010989320

1112K



L mm 200 € 28,50 2 011129020

1122K



L mm 250 € 38,50 2 011229020

1123K



L mm 250 € 38,50 2 011239020

1124K



L mm 250 € 38,50 2 011249020

1128BAX



L mm 150 € 35,50 5 011280088

1128BMX



L mm 147 € 18,90 5 011280051

1128BSX



L mm 148 € 32,50 5 011280061

1128FX



L mm 145 € 34,50 5 011280090

1128FXS



L mm 145 € 41,00 5 011280095

1129BMK



L mm 145 € 18,40 5 011299000

1130BMX



L mm	€	Icon	Code
185	21,20	1	011300002

1132K



L mm	€	Icon	Code
170	54,50	2	011329107

1132BMK



L mm	€	Icon	Code
170	67,00	2	011329137

1142BMK



L mm	€	Icon	Code
160	44,00	3	011429036

1144T



L mm	€	Icon	Code
112	22,50	1	011440060

1149F



L mm	€	Icon	Code
175	18,60	1	011490010

1150K



L mm	€	Icon	Code
160	24,80	5	011509046
180	27,00	5	011509048
200	29,00	5	011509050
220	32,00	2	011509052

1150GK



L mm	€	Icon	Code
160	23,10	5	011509066
180	25,00	5	011509068
200	28,00	5	011509070
220	29,00	2	011509072

1150BMK



L mm	€	Icon	Code
160	30,50	3	011509146
180	34,00	3	011509148
200	37,00	3	011509150
220	39,50	2	011509152

1150GBMK



L mm	€	Icon	Code
160	28,50	3	011509266
180	30,50	3	011509268
200	35,00	3	011509270
220	37,00	2	011509272

1162K



L mm	€	Icon	Code
160	29,00	5	011629006
200	34,00	5	011629010

1162GK



L mm	€	Icon	Code
160	24,80	5	011629066
200	28,50	5	011629070

1162BMK



L mm	€	Icon	Code
160	35,50	3	011629036
200	39,50	3	011629040

1162GBMK



L mm	€	Icon	Code
160	30,50	3	011629266
200	36,00	3	011629270

1164K



L mm	€	Icon	Code
160	31,50	5	011649006
200	35,50	5	011649010

1164BMK



L mm	€	Icon	Code
160	38,50	3	011649036
200	43,50	3	011649040

1166K



L mm	€	Icon	Code
160	29,00	5	011669006
200	34,00	5	011669010

1166GK



L mm	€	🔧	📦
160	24,80	5	011669066
200	28,50	5	011669070

1166BMK



L mm	€	🔧	📦
160	35,50	3	011669036
200	39,50	3	011669040

1166GBMK



L mm	€	🔧	📦
160	30,50	3	011669266
200	36,00	3	011669270

1168K



L mm	€	🔧	📦
160	31,50	5	011689006
200	35,50	5	011689010

1168GK



L mm	€	🔧	📦
160	27,00	5	011689066
200	30,50	5	011689070

1168BMK



L mm	€	🔧	📦
160	38,50	3	011689036
200	43,50	3	011689040

1168GBMK



L mm	€	🔧	📦
160	34,50	3	011689266
200	38,50	3	011689270

1201E/K



SxAxL mm	€	🔧	📦
0,4x2,5x50	4,50	5	012019203
0,4x2,5x75	4,70	5	012019206
0,5x3x75	4,75	5	012019209
0,5x3x100	5,10	5	012019212
0,6x3,5x75	5,10	5	012019218
0,6x3,5x100	5,25	5	012019221
0,8x4x100	5,30	5	012019230
0,8x4x125	5,60	5	012019233
0,8x4x150	6,05	5	012019236
1,0x5,5x100	6,55	5	012019239
1,0x5,5x125	6,90	5	012019240
1,0x5,5x150	7,00	5	012019242
1,2x6,5x100	7,80	5	012019248
1,2x6,5x125	8,05	5	012019250
1,2x6,5x150	8,20	5	012019251
1,2x8x150	10,60	3	012019257
1,2x8x200	11,20	3	012019260
1,6x10x200	13,00	3	012019266

1201EN/K



SxAxL mm	€	🔧	📦
0,8x4x30	6,50	3	012019303
1,2x6,5x30	6,75	3	012019306

1202E/K



PHxDxL mm	€	🔧	📦
0x3x60	4,70	5	012029203
0x3x100	5,25	5	012029206
1x4,5x80	6,00	5	012029209
1x4,5x120	6,70	5	012029212
2x6x100	8,05	5	012029218
2x6x150	8,65	5	012029221
3x8x150	10,90	3	012029224
4x9,5x200	14,20	3	012029227



1202EN/K



PHxDxL mm	€	🔧	📦
1x4,5x30	6,50	3	012029303
2x6x30	6,75	3	012029306

1204E/K



SxDxL mm	€	🔧	📦
0,4x2,5x60	4,65	5	012049103
0,6x3x75	4,75	5	012049106
0,5x3x100	4,85	5	012049109
0,8x4x100	5,45	5	012049112
0,8x4x125	5,70	5	012049115
1,0x5x125	6,60	5	012049118
1,0x5x150	7,15	5	012049121
1,2x6,5x150	7,80	5	012049124

1207E TX/K



Type	€	🔧	📦
T5	6,90	5	012079105
T6	7,30	5	012079106
T7	7,45	5	012079107
T8	7,60	5	012079108
T9	7,95	5	012079109
T10	9,00	5	012079110
T15	9,10	5	012079115
T20	9,25	5	012079120
T25	9,50	5	012079125
T27	10,10	5	012079127
T30	10,20	5	012079130
T40	11,90	2	012079140
T45	13,10	2	012079145

1208E RTX/K



Type	€	🔧	📦
T9	8,05	5	012089109
T10	9,00	5	012089110
T15	9,50	5	012089115
T20	9,70	5	012089120
T25	9,90	5	012089125
T27	10,60	5	012089127
T30	11,10	5	012089130
T40	13,20	2	012089140

1209E PZ/K



Type	€	🔧	📦
PZ 0	5,45	5	012099200
PZ 1	7,00	5	012099203
PZ 2	9,00	5	012099206
PZ 3	13,50	3	012099209
PZ 4	14,70	3	012099212

1209EN-PZ/K



	€		
1	6,50	3	012099303
2	6,75	3	012099306

1253



SxAxL mm	€		
0,5x3,5x100	10,30	5	012530001

1254



SxAxL mm	€		
0,5x3x44	11,30	5	012540001

1260K



SxAxL	€		
0,4x2,5x50	6,25	5	012609003
0,4x2,5x75	6,45	5	012609006
0,5x3x75	6,60	5	012609009
0,5x3x100	6,85	5	012609012
0,6x3,5x75	7,05	5	012609018
0,6x3,5x100	7,15	5	012609021
0,8x4x100	7,80	5	012609030
0,8x4x125	8,10	5	012609033
0,8x4x150	8,45	5	012609036
1x5,5x100	8,90	5	012609039
1x5,5x150	9,95	5	012609042
1,5x6,5x100	10,60	5	012609048
1,2x6,5x150	11,40	5	012609051
1,2x8x150	13,90	3	012609057
1,2x8x200	14,30	3	012609060
1,6x10x200	17,30	3	012609066

1260NK



SxAxL mm	€		
0,8x4x30	8,20	5	012609103
1,2x6,5x30	9,15	5	012609106

1260EK



SxAxL mm	€		
1,2x6,5x150	14,70	3	012609156
1,2x8x175	18,10	3	012609157
1,6x10x200	20,70	2	012609159
2x12x250	24,00	2	012609162

1262K



PHxDxL mm	€		
0x3x60	6,60	5	012629003
0x3x100	7,00	5	012629006
1x4,5x80	8,65	5	012629009
1x4,5x120	9,40	5	012629012
2x6x100	10,60	5	012629018
2x6x150	11,50	5	012629021
3x8x150	15,30	3	012629024
4x10x200	19,50	3	012629027

1262NK



PHxDxL	€		
1x4,5x30	8,20	5	012629103
2x6x30	9,15	5	012629106

1262EK



PHxDxL mm	€		
2x6x150	14,70	3	012629153
3x8x175	17,90	3	012629156
4x10x200	22,30	3	012629159

1264K



SxDxL mm	€		
0,5x2,5x60	6,25	5	012649003
0,6x3x75	6,60	5	012649006
0,6x3x100	6,85	5	012649009
0,8x4x100	7,80	5	012649012
0,8x4x125	8,10	5	012649015
1x5x125	9,15	5	012649018
1x5x150	9,60	5	012649021
1,2x6,5x150	11,40	5	012649024

1267TXK



Ø	€		
T5	9,25	5	012679005
T6	9,60	5	012679006
T7	9,95	5	012679007
T8	10,40	5	012679008
T9	10,70	5	012679009
T10	11,10	5	012679010
T15	11,70	5	012679015
T20	12,30	5	012679020
T25	13,40	5	012679025
T27	13,90	5	012679027
T30	14,60	5	012679030
T40	16,90	2	012679040
T45	18,60	2	012679045

1268RTXK



Ø	€		
T9	11,60	3	012689009
T10	12,00	3	012689010
T15	12,30	3	012689015
T20	13,40	3	012689020
T25	13,70	3	012689025
T27	14,60	3	012689027
T30	14,80	3	012689030
T40	17,10	2	012689040

1269PZK



PZ	€		
0	7,55	5	012699000
1	9,80	5	012699001
2	11,60	5	012699002
3	16,50	3	012699003
4	20,90	3	012699004

1269N/PZK



PZ	€		
1	8,20	5	012699011
2	9,15	5	012699012

1290K



SxAxL mm	€	🔧	📦
0,4x2,5x50	7,95	5	012909003
0,4x2,5x75	8,20	5	012909006
0,5x3x75	8,40	10	012909009
0,5x3x100	8,80	10	012909012
0,6x3,5x75	9,50	10	012909018
0,6x3,5x100	9,70	10	012909021
0,8x4x100	9,80	10	012909030
0,8x4x125	10,10	10	012909033
0,8x4x150	10,60	10	012909036
1x5,5x100	10,80	10	012909039
1x5,5x150	11,90	10	012909042
1,2x6,5x100	13,40	10	012909048
1,2x6,5x150	14,10	10	012909051
1,2x8x150	17,60	3	012909057
1,2x8x200	18,70	3	012909060
1,6x10x200	21,70	3	012909066

1290NK



SxAxL mm	€	🔧	📦
0,8x4x30	10,30	5	012909103
1,2x6,5x30	11,30	5	012909106

1290K/INOX



SxAxL mm	€	🔧	📦
0,4x2,5x50	10,20	4	012909403
0,5x3x75	10,50	4	012909409
0,8x4x100	10,70	4	012909430
1,0x5,5x150	13,60	4	012909442
1,2x6,5x150	15,50	4	012909451

1292K



PHxDxL mm	€	🔧	📦
0x3x60	7,60	10	012929003
0x3x100	8,65	5	012929006
1x4,5x80	10,40	10	012929009
1x4,5x120	11,40	10	012929012
2x6x100	13,60	10	012929018
2x6x150	14,50	10	012929021
3x8x150	18,50	3	012929024
4x10x200	25,00	3	012929027

1292NK



PHxDxL mm	€	🔧	📦
1x4,5x30	9,90	5	012929103
2x6x30	10,70	5	012929106

1292K/INOX



PHxDxL mm	€	🔧	📦
0x3x60	9,50	4	012929403
1x4,5x80	11,10	4	012929409
2x6x100	13,60	4	012929418

1294K



SxDxL mm	€	🔧	📦
0,5x2,5x60	7,40	5	012949003
0,6x3x75	7,85	5	012949006
0,8x4x100	9,80	5	012949012
1x5x125	12,00	5	012949018

1298RTXK



	€	🔧	📦
T9	16,10	5	012989009
T10	16,40	5	012989010
T15	17,40	5	012989015
T20	17,50	5	012989020
T25	18,00	5	012989025
T27	19,30	5	012989027
T30	19,90	5	012989030
T40	21,30	2	012989040

1299PZK



PZ	€	🔧	📦
0	10,80	5	012999000
1	12,70	5	012999003
2	17,10	5	012999006

1299N/PZK



PZ	€	🔧	📦
1	12,20	5	012999021
2	13,60	5	012999024

1472VW



L mm	€	🔧	📦
200	49,50	1	014720051

1473P



A Max mm	€	🔧	📦
53	38,50	1	014730020

1497BS

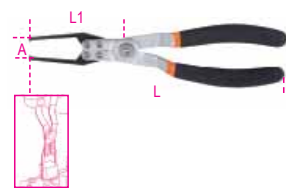

L mm	€	🔧	📦
230	24,60	1	014970190

1497SS



L mm	€	🔧	📦
245	22,40	1	014970195

Beta
Quality tools

1497RC



1497RC € 80,00 1 014970351

1600Q 8



1600Q 8 € 31,00 1 016000008

1600Q 10



1600Q 10 € 39,50 1 016000010

1603K



mm² 0÷8 € 18,00 5 016039001

1603BK



mm² 0÷8 € 66,50 2 016039010

1651DGTB

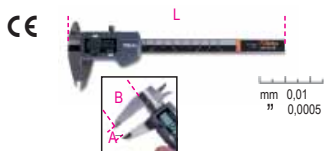

A Max mm	€		
150	109,00	1	016510211
200	142,00	1	016510212
300	185,50	1	016510213



1651DGTB/IP

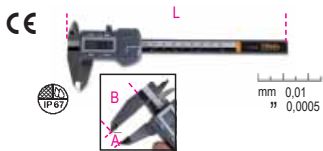

A Max mm 150 € 178,00 1 016510711

1691BM



L m	€		
5	17,00	1	016910205
8	25,50	1	016910208
10	31,00	1	016910210

1691MG



L m	€		
5	15,30	1	016910405
8	21,40	1	016910408
10	22,60	1	016910410

1692



L m	€		
2	8,25	5	016920052
3	10,30	5	016920053
5	14,70	5	016920055
8	21,20	5	016920058

1693

CE



IP54



H mm 100 € 130,50 1 016930020

1729CG



L mm 310 € 25,00 2 017290200

1729DM 450



L mm 450 € 28,50 4 017290450

1741U



Ø mm	2,4	3	3,2	4	4,8
Alluminio	•	•	•	•	•
Acciaio	•	•	•	•	
Inox	•	•	•	•	

1741U € 49,00 1 017410450



1741B



250 mm

Ø mm	2,4	3,2	4	4,8	5
Alluminio	•	•	•	•	•
Acciaio	•	•	•	•	•
Inox	•	•	•	•	•

1741B € 41,50 1 017410000

1760K

CE



180 mm

CAT III-1000V

1760K € 39,50 1 017600140

1762K



Ø mm
2-2,5-3
3,5-4-4,5

€ 34,00 2 017629001

1771



18 mm

170 mm

1771 € 9,95 10 017710000

1770BM



L mm
140

€ 13,40 10 017700050

1771BM



L mm
170

€ 21,70 10 017710050

1771HD



L mm
190

€ 24,40 5 017710100

1772R



L mm
125

€ 18,30 5 017720006

1773A



L mm
180

€ 19,30 10 017730000

1773S



L mm
190

€ 9,00 1 017730100

1777BMT



L mm
170

€ 29,50 5 017770050

1777T



L mm
160

€ 27,50 5 017770030

1778MT



L mm
180

€ 105,00 1 017780055

1783



L mm
215
240

€ 16,10
18,00

5
5

017830021
017830024

1820



CE

L=1,25 m
230V
Shuko

€ 51,50 1 018200003

1820 30
30W
L = 210mm

€ 59,00 1 018200006

1820 60
60W
L = 220mm

€ 83,50 1 018200008

1820 80
80W
L = 260mm



1822



1822 120 120W LxA = 250x125 mm	€ 127,50	1	018220012
1822 180 180W LxA = 250x125mm	€ 135,00	1	018220018
1822 320 320W LxA = 250x140mm	€ 168,00	1	018220032

1833XSW



L mm 145	€ 49,50	1	018330011
-------------	---------	---	-----------

1833S



L mm 150	€ 39,50	1	018330002
-------------	---------	---	-----------

1833M



L mm 162	€ 49,50	1	018330003
-------------	---------	---	-----------

1833MW



L mm 160	€ 90,50	1	018330013
-------------	---------	---	-----------



1833L



L mm 196	€ 82,50	1	018330004
-------------	---------	---	-----------

1833XL



L mm 300	€ 103,50	1	018330005
-------------	----------	---	-----------

1833L/USB



L mm 240	€ 121,50	1	018330054
-------------	----------	---	-----------

1836AW



1836AW	€ 74,50	1	018360051
--------	---------	---	-----------

1836B



1836B	€ 135,00	1	018360200
-------	----------	---	-----------

1837F



L mm 460	€ 89,50	1	018370050
-------------	---------	---	-----------

1837F/USB



L mm 460	€ 132,50	1	018370060
-------------	----------	---	-----------

1838COB



1838COB	€ 97,00	1	018380010
---------	---------	---	-----------



1838P



1838P	€ 83,00	1	018380005
-------	---------	---	-----------

1838POCKET



1838POCKET	€ 70,50	1	018380080
------------	---------	---	-----------

1838SLIM



1838SLIM	€ 75,50	1	018380221
----------	---------	---	-----------

1838SW



1838SW	€ 100,50	1	018380142
--------	----------	---	-----------

1839BRW



1839BRW	€ 95,00	1	018390002
---------	---------	---	-----------

1860M



1860M	€ 98,00	1	018600301
-------	---------	---	-----------

1875SP/K3



1875SP/K3	€ 19,40	1	018750010
-----------	---------	---	-----------

1949F2



1949F2	€ 18,00	1	019490028
--------	---------	---	-----------

1949XS



1949XS	€ 7,15	25	019490025
--------	--------	----	-----------

6888B1/4

supporto blister per bussole 1/4"



6888B1/4	€ 0,70	50	068880900
----------	--------	----	-----------

6888B3/8

supporto blister per bussole 3/8"



6888B3/8	€ 0,83	50	068880910
----------	--------	----	-----------

6888B1/2

supporto blister per bussole 1/2"



6888B1/2	€ 0,83	50	068880920
----------	--------	----	-----------



Beta



SOLUZIONI
ESPOSITIVE
PER IL PUNTO VENDITA

SHOP
in shop



PROGETTA il tuo corner Beta

www.beta-tools.com/planner3d/

38/DS1

espositore da parete
con 75 utensili a percussione

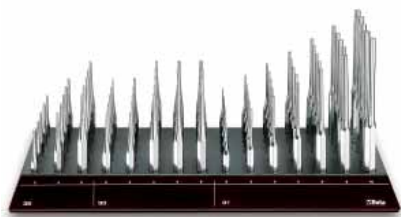

495x260x332 mm

Espositore
con assortimento
38/DS1 € 751,00 1 000380701

n.

30	Ø 2 - 3 - 4 - 5 - 6 mm	5
31	Ø 2 - 3 - 4 - 5 - 6 - 8 - 10 mm	5
32	Ø 3 - 4 - 5 mm	5

Espositore
vuoto
38/DVS1 € 117,50 1 000380751

38/DS2

espositore da parete
con 65 utensili a percussione

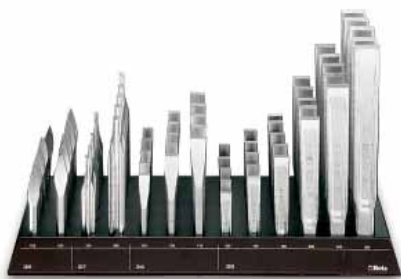

495x260x332 mm

Espositore
con assortimento
38/DS2 € 1.420,00 1 000380702

n.

34	125 - 150 - 175 mm	5
35	100 - 125 - 150 - 200 - 250 - 300 mm	5
36	125 - 150 mm	5
37	150 - 200 mm	5

Espositore
vuoto
38/DVS2 € 117,50 1 000380752

942BX/DG

espositore da parete
con 43 chiavi a bussola esagonale
con impugnatura tipo corto



330x260x332 mm

Espositore
con assortimento
942BX/DG € 753,00 1 009420701

n.

942BX	5 - 5,5 mm	3
	6 - 7 mm	6
	8 - 9 - 10 mm	5
	11 mm	2
	12 mm	3
	13 mm	5

Espositore
vuoto
942BX/DVG € 104,00 1 009420751

943BX/DG

espositore da parete
con 43 chiavi a bussola esagonale
con impugnatura tipo lungo



330x260x332 mm

Espositore
con assortimento
943BX/DG € 809,00 1 009430701

n.

943BX	5 - 5,5 mm	3
	6 - 7 mm	6
	8 - 9 - 10 mm	5
	11 mm	2
	12 mm	3
	13 mm	5

Espositore
vuoto
943BX/DVG € 104,00 1 009430751

944BX/DG

espositore da parete
con 43 chiavi a bussola esagonale profonda
con impugnatura tipo lungo



330x260x332 mm

Espositore
con assortimento
944BX/DG € 936,00 1 009440701

n.

944BX	5 - 5,5 mm	3
	6 - 7 mm	6
	8 - 9 - 10 mm	5
	11 mm	2
	12 mm	3
	13 mm	5

Espositore
vuoto
944BX/DVG € 104,00 1 009440751

943MQ/BG

espositore da parete
con 30 chiavi a bussola esagonale
con impugnatura



⚠1000 V ⚡

330x260x332 mm

Espositore
con assortimento
943MQ/BG € 657,00 1 009430281

n.

943MQ	5,5 - 6 - 7 - 8 - 10 - 13 mm	5
-------	------------------------------	---

Espositore
vuoto
943BG-MQ/DV € 104,00 1 009430285

1203/E1P

espositore da parete
con 82 giravite



495x260x310 mm

Espositore
con assortimento
1203E/E1P € 493,00 1 012031301

		n.
1201	0,4x2,5x50 - 0,5x3x75 - 0,6x3,5x100	7
	0,8x4x100 - 0,8x4x125 mm	6
	1,0x5,5x100 - 1,0x5,5x150 - 1,2x6,5x150 mm	6
	1,2x8x150 mm	5
1202	PH0x3x60 mm	7
	PH1x4,5x80 - PH2x6x100 mm	6
	PH3x8x150 mm	5

Espositore
vuoto
1203E/EV1P € 130,00 1 012031351

1203/E4P

espositore da parete
con 85 giravite



495x260x310 mm

Espositore
con assortimento
1203E/E4P € 474,00 1 012031304

		n.
1201	0,4x2,5x50 - 0,5x3x75 - 0,8x4x125 mm	7
	1,0x5,5x100 - 1,0x5,5x150 - 1,2x6,5x150 mm	6
1204	0,4x2,5x60 - 0,5x3x100 - 0,8x4x100 mm	7
	1,0x5x125 mm	6
1209PZ	PZ0x3x60 mm	7
	PZ1x4,5x80 - PZ2x6x100 mm	6

Espositore
vuoto
1203E/EV4P € 130,00 1 012031354

1203/E5P

espositore da parete
con 82 giravite



495x260x310 mm

Espositore
con assortimento
1203E/E5P € 502,00 1 012031305

		n.
1202	PH0x3x60 mm	7
	PH1x4,5x80 - PH1x4,5x120	6
	PH2x6x100 - PH2x6x150 mm	6
	PH3x8x150 mm	5
1204	0,4x2,5x60 - 0,5x3x100 - 0,8x4x100 mm	7
	1,0x5x125 mm	6
1209PZ	PZ0x3x60 mm	7
	PZ1x4,5x80 - PZ2x6x100 mm	6

Espositore
vuoto
1203E/EV5P € 130,00 1 012031355

1203/E10P

espositore da parete
con 80 giravite



495x260x310 mm

Espositore
con assortimento
1203E/E10P € 675,00 1 012031310

		n.
1207TX	T6	4
	T7	3
	T8	7
	T9 - T10 - T15 - T20 - T25	6
	T27 - T30	3
1208RTX	T9 - T10	3
	T15 - T20 - T25	6
	T27 - T30	3

Espositore
vuoto
1203E/EV10P € 130,00 1 012031360

1263/E78

Espositore da parete con 78 giravite



495x260x310 mm

Espositore
con assortimento
1263/E78 € 652,00 1 012630510

		n.
1260	2,5x75-3x75-3,5x100 mm	7
	4x100-4x125-5,5x100-5,5x150-6,5x150 mm	6
	8x150 mm	4
1262	PH0x60 mm	7
	PH1x80-PH2x100 mm	6
	PH3x150	4

Espositore
vuoto
1263/EV78 € 120,00 1 012630511

1263/E74

espositore da parete
con 74 giravite



495x260x310 mm

Espositore
con assortimento
1263/E74 € 610,00 1 012630540

		n.
1264	2,5x60 mm	7
	3x75 mm	3
	3x100 - 4x100 mm	4
	4x125 - 5x150 mm	2
	5x125 - 6,5x150 mm	4
1262	PH 8x150	3
	PH 3x60 - 3x100 mm	7
	PH 4,5x80 - 4,5x120 mm	6
	PH 6x100 mm	10
	PH 6x150 mm	5

Espositore
vuoto
1263/EV74 € 120,00 1 012630541

1263/E85

espositore da parete
con 85 giravite



495x260x377 mm

Espositore
con assortimento
1263/E85 € 726,00 1 012630550

	n.
● 1260 2,5x50 mm	7
2,5x75 mm	6
3x75 - 3x100 - 3,5x100 mm	7
4x100 - 4x125 - 5,5x125	6
5,5x150 - 6,5x150 mm	4
8x150 mm	4
● 1260E 10x200 mm	3
12x250 mm	2
4x30 - 6,5x30 mm	6

Espositore
vuoto
1263/EV85 € 120,00 1 012630551

1263/E70

espositore da parete
con 70 giravite



495x260x327 mm

Espositore
con assortimento
1263/E70 € 715,00 1 012630560

	n.
⊕ 1262 PH0x60 - PH0x100 mm	7
PH1x80 - PH1x120 mm	6
PH2x100 mm	9
PH2x150 - PH3x150 mm	5
PH4x200 mm	4
⊕ 1262E PH2x150 mm	5
PH3x175 mm	4
⊕ 1262N PH1x30 - PH2x30 mm	6

Espositore
vuoto
1263/EV70 € 120,00 1 012630561

1263/E50

espositore da parete
con 50 giravite



330x260x269 mm

Espositore
con assortimento
1263/E50 € 375,00 1 012630570

	n.
● 1264 2,5x60 - 3x75 - 3x100 mm	7
4x100 - 4x125 - 5x125 - 5x150 mm	6
6,5x150 mm	5

Espositore
vuoto
1263/EV50 € 104,00 1 012630571

1263/E62

espositore da parete
con 62 giravite



495x260x257 mm

Espositore
con assortimento
1263/E62 € 691,00 1 012630590

	n.
⊕ 1267TX T5	5
T6	6
T7	5
T8	6
T9	5
T10 - T15 - T20	6
T25	5
T27 - T30	4
T40 - T45	2

Espositore
vuoto
1263/EV62 € 120,00 1 012630591

1263/E39

espositore da parete
con 39 giravite



330x260x257 mm

Espositore
con assortimento
1263/E39 € 489,00 1 012630595

	n.
⊕ 1268RTX T9x60 - T10x80 - T15x80	6
T20x100 - T25x100 mm	4
T27x115 mm	3
T30x115 mm	2
T40x130 mm	2

Espositore
vuoto
1263/EV39 € 104,00 1 012630596

1263/E40

espositore da parete
con 40 giravite



330x260x327 mm

Espositore
con assortimento
1263/E40 € 434,00 1 012630580

	n.
⊕ 1269 PZ0x60 mm	7
PZ1x80 mm	6
PZ2x100 - PZ3x150 - PZ4x200 mm	5
⊕ 1269N PZ1x30 - PZ2x30 mm	6

Espositore
vuoto
1263/EV40 € 104,00 1 012630581

1273MQ/E1

espositore da parete
con 40 giravite



△ 1000 V ⚡

330x260x332 mm

Espositore
con assortimento
1273MQ/E1 € 551,00 1 012730312

	n.
➕ 1272MQ PH0x60 - PH1x80 mm	5
PH2x100 mm	3
PH3x150 mm	2
● 1274MQ 3x100 - 4x100 - 5,5x125 - 6,5x150 mm	5
8x175 mm	3
10x200 mm	2

Espositore
vuoto
1273BG-MQ/DV € 104,00 1 012730651

1273MQ/E4

espositore da parete
con 43 giravite



△ 1000 V ⚡

330x260x332 mm

espositore da parete
con assortimento
1273MQ/E4 € 748,00 1 012730315

➕ 1272MQF 4,5x80 - 6x100 mm	3
● 1274MQF 3,5x100 - 4,5x100 - 5,5x125 - 6,5x150 mm	3
➕ 1275MQ/C 4,5x80 - 6x100 mm	5
➕ 1276MQ/C 4,5x80 - 6x100 mm	5
➕ 1279MQ/F 4,5x80 mm	3
6x100 mm	2

Espositore
vuoto
1273BG-MQ/DV4 € 104,00 1 012730655

1293BX/DA

espositore da parete
con 90 giravite



495x260x332 mm

Espositore
con assortimento
1293BX/DA € 971,00 1 012930701

● 1290 3x75 - 3,5x100 - 4x100 - 4x125 5,5x100 - 5,5x150 mm	7
6,5x150 mm	6
8x150 mm	3
10x200 mm	2
● 1290N 4x30 - 6,5x30 mm	3
➕ 1292 PH0x60 - PH1x80 mm	7
PH2x100 mm	6
PH3x150 mm	5
➕ 1292N PH1x30 - PH2x30 mm	3

Espositore
vuoto
1293BX/DVA € 120,50 1 012930751

1293BX/DD

espositore da parete
con 48 giravite



330x260x332 mm

Espositore
con assortimento
1293BX/DD € 460,00 1 012930704

● 1294 2,5x60 - 3x75 - 3x100 - 4x100 4x150 - 5x125 mm	7
6,5x150 mm	6

Espositore
vuoto
1293BX/DVD € 105,00 1 012930754

1293BX/DE

espositore da parete
con 42 giravite



330x260x332 mm

Espositore
con assortimento
1293BX/DE € 686,00 1 012930705

➕ 1299PZ PZ0x60 - PZ1x80 mm	7
PZ2x100 mm	6
PZ3x150 - PZ4x200 mm	5
➕ 1299N/PZ PZ1x30 - PZ2x30 mm	6

Espositore
vuoto
1293BX/DVE € 105,00 1 012930755

1293BX/DF

espositore da parete
con 59 giravite



330x260x332 mm

Espositore
con assortimento
1293BX/DF € 908,00 1 012930706

● 1297TX T6 - T8 - T10 - T15 - T20 - T25 T27 - T30	7
T40	6
	5

Espositore
vuoto
1293BX/DVF € 105,00 1 012930756

C68

parete espositiva vuota Beta



1000x560x2200 mm

C68/1	1 m	2.235,00	1	068000001
C68/2	2 m	3.890,00	1	068000002
C68/3	3 m	5.550,00	1	068000003
C68/4	4 m	7.210,00	1	068000004
C68/5	5 m	8.860,00	1	068000005
C68/6	6 m	10.520,00	1	068000006
C68/7	7 m	12.180,00	1	068000007
C68/8	8 m	13.840,00	1	068000008
C68/9	9 m	15.490,00	1	068000009
C68/10	10 m	17.150,00	1	068000010

C68N

parete espositiva vuota Beta



1000x560x2200 mm

C68N/1	1 m	1.925,00	1	068000031
C68N/2	2 m	3.580,00	1	068000032
C68N/3	3 m	5.240,00	1	068000033
C68N/4	4 m	6.900,00	1	068000034
C68N/5	5 m	8.550,00	1	068000035
C68N/6	6 m	10.210,00	1	068000036
C68N/7	7 m	11.870,00	1	068000037
C68N/8	8 m	13.530,00	1	068000038
C68N/9	9 m	15.180,00	1	068000039
C68N/10	10 m	16.840,00	1	068000040

C68 G

gondola espositiva vuota



1000x1120x1600 mm

C68G/1	1 m	2.035,00	1	068000051
C68G/2	2 m	3.750,00	1	068000052
C68G/3	3 m	5.460,00	1	068000053
C68G/4	4 m	7.170,00	1	068000054

C88 R/1

parete espositiva vuota Robur



1000x560x2200 mm

C88R/1	1 m	2.235,00	1	088000001
--------	-----	----------	---	-----------

C88NR/1

parete espositiva vuota Robur



1000x560x2200 mm

C88NR/1	1 m	1.925,00	1	088000031
---------	-----	----------	---	-----------

C88VE

vasca espositiva per pareti C88 R/1

adatta ad alloggiare bobine di catena art.8120



C88VE		238,50	1	088000120
-------	--	--------	---	-----------

C88SE

espositore per bobine di catena genovese



C88SE		576,00	1	088000130
-------	--	--------	---	-----------

1700x600x600 mm



6888

ganci per espositori C60 - C61 - C68 - C88

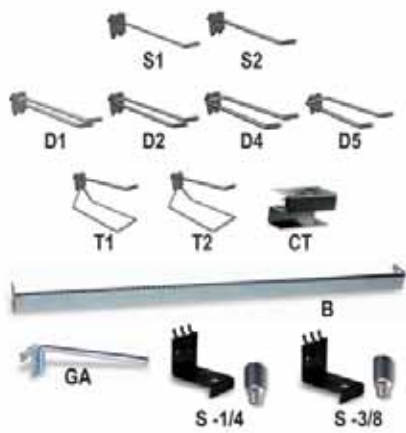

	€		
6888S1	4,60	10	068880011
6888S2	4,60	10	068880012
6888D1	7,25	5	068880021
6888D2	7,25	5	068880022
6888D4	7,45	5	068880024
6888D5	7,45	5	068880025
6888T1	10,30	5	068880031
6888T2	10,30	5	068880032
6888CT	19,40	1	068880044
6888B	69,00	1	068880100
6888GA	22,80	3	068880120
6888S-1/4	41,50	1	068880605
6888S-3/8	41,50	1	068880610

6800 VE

vetrina per parete espositiva C68 e C68 R/1



	€		
6800VE/1	1.115,00	1	068000401
6800VE/2	1.700,00	1	068000402
6800VE/3	2.285,00	1	068000403
6800VE/4	2.870,00	1	068000404
6800VE/5	3.460,00	1	068000405

ACCESSORI C68



	€		
6800AE	222,50	1	068000145
6800AI	460,00	1	068000140
6800AD/P	782,00	1	068000143



	€		
6800CB/100	257,00	1	068000104
6800FB/100	90,50	1	068000109
6800FO/100	62,00	1	068000108
6800PL	261,00	1	068000137
6800RP/100	82,50	1	068000150
6800GR/37	35,00	1	068000159

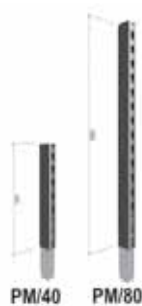

	€		
6800PM/40	82,50	1	068000171
6800PM/80	111,50	1	068000172

6600 M/14

assortimento 154 utensili, con ganci senza pannello

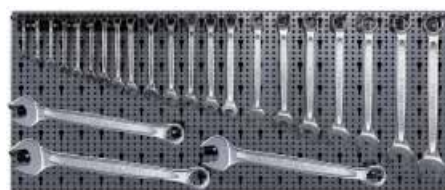

	€		
6600 M/14	2.490,00	1	066000014

6600 M/22

assortimento 108 utensili, con ganci senza pannello



	€		
6600 M/22	1.650,00	1	066000022

6600 M/27

assortimento 25 utensili, con ganci senza pannello



	€		
6600 M/27	1.148,00	1	066000027

6600 M/29

assortimento 173 utensili, con ganci senza pannello

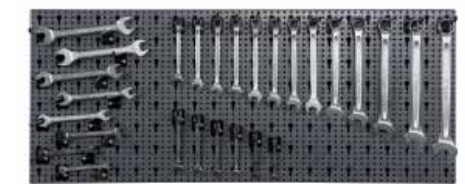

	€		
6600 M/29	2.195,00	1	066000029

6600 M/33

assortimento 37 utensili, con ganci senza pannello



	€		
6600 M/33	1.835,00	1	066000033

 Beta

6600 M/40

assortimento 100 utensili,
con ganci senza pannello

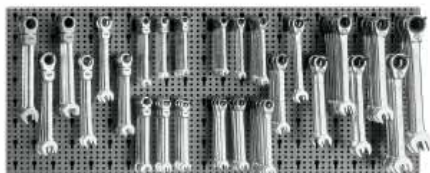

6600 M/40 € 2.730,00 1 066000040

6600 M/42

assortimento di 65 utensili,
con ganci senza pannello



6600 M/42 € 1.760,00 1 066000042

6600 M/44

assortimento 48 utensili,
con ganci senza pannello

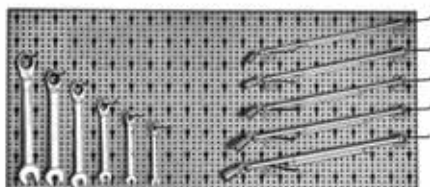

6600 M/44 € 1.525,00 1 066000044

6600 M/47

assortimento 65 utensili,
con ganci senza pannello



6600 M/47 € 1.635,00 1 066000047

6600 M/51

assortimento di 257 utensili
con ganci senza pannello



6600 M/51 € 2.910,00 1 066000051

6600 M/52

assortimento di 176 utensili
con ganci senza pannello



6600 M/52 € 1.900,00 1 066000052

6600 M/58

assortimento di 150 utensili
con ganci senza pannello



6600 M/58 € 2.065,00 1 066000058

6600 M/59

assortimento 220 utensili,
con ganci senza pannello



6600 M/59 € 2.200,00 1 066000059

6600 M/61

assortimento 71 utensili,
con ganci senza pannello

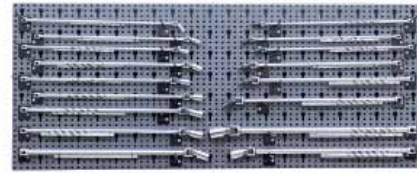

6600 M/61 € 2.630,00 1 066000061

6600 M/62

assortimento 28 utensili,
con ganci senza pannello

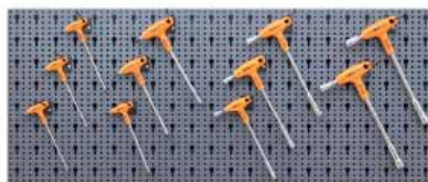

6600 M/62 € 618,00 1 066000062

6600 M/63

assortimento di 110 utensili
con ganci senza pannello

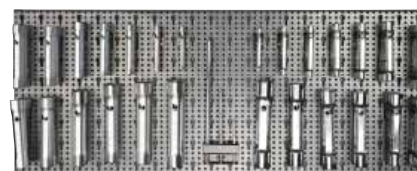

6600 M/63 € 2.390,00 1 066000063

6600 M/73

assortimento di 68 utensili
con ganci senza pannello

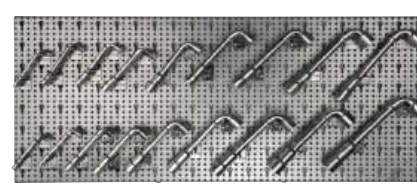

6600 M/73 € 1.560,00 1 066000073

6600 M/112

assortimento 329 utensili,
con ganci senza pannello



6600 M/112 € 2.590,00 1 066000112

6600 M/116

assortimento 306 utensili,
con ganci senza pannello



6600 M/116 € 2.420,00 1 066000116

6600 M/120

assortimento 163 utensili,
con ganci senza pannello



6600 M/120 € 1.775,00 1 066000120

6600 M/125

assortimento 133 utensili,
con ganci senza pannello



6600 M/125 € 1.530,00 1 066000125

6600 M/126

assortimento 58 utensili,
con ganci senza pannello



6600 M/126 € 925,00 1 066000126

6600 M/131

assortimento 92 utensili,
con ganci senza pannello



6600 M/131 € 2.910,00 1 066000131

6600 M/174

assortimento 13 utensili, con ganci senza
pannello



6600 M/174 € 4.360,00 1 066000174

6600 M/175

assortimento 12 utensili,
con ganci senza pannello



6600 M/175 € 3.150,00 1 066000175

6600 M/217

assortimento di 74 utensili
con ganci senza pannello



6600 M/217 € 2.840,00 1 066000217

6600 M/218

assortimento 58 utensili,
con ganci senza pannello

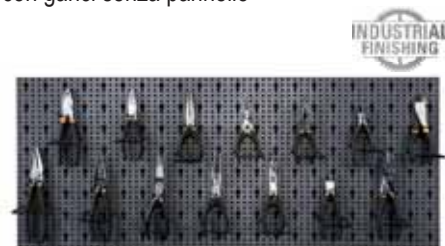

6600 M/218 € 1.500,00 1 066000218

6600 M/222

assortimento di 74 utensili,
con ganci senza pannello



6600 M/222 € 2.305,00 1 066000222

6600 M/223

assortimento 58 utensili,
con ganci senza pannello



6600 M/223 € 1.960,00 1 066000223

6600 M/230

assortimento 78 utensili,
con ganci senza pannello



6600 M/230 € 2.520,00 1 066000230

6600 M/236

assortimento 31 utensili,
con ganci senza pannello



6600 M/236 € 1.420,00 1 066000236

6600 M/241

assortimento di 43 utensili,
con ganci senza pannello



6600 M/241 € 1.220,00 1 066000241

6600 M/242

assortimento di 91 utensili
con ganci senza pannello



6600 M/242 € 2.940,00 1 066000242

6600 M/253

assortimento 60 utensili,
con ganci senza pannello



6600 M/253 € 2.060,00 1 066000253

6600 M/311

assortimento 114 utensili,
con ganci senza pannello



6600 M/311 € 1.240,00 1 066000311

6600 M/315

assortimento 149 utensili,
con ganci senza pannello

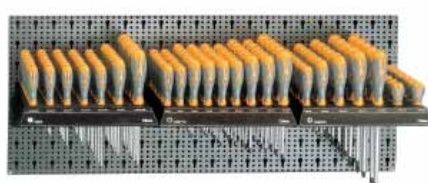

6600 M/315 € 2.055,00 1 066000315

6600 M/320

assortimento 98 utensili,
con ganci senza pannello

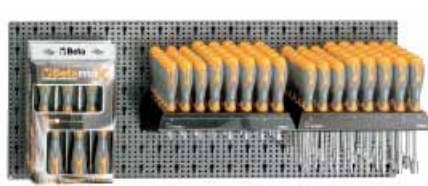

6600 M/320 € 1.785,00 1 066000320

6600 M/326

assortimento 155 utensili,
con ganci senza pannello



6600 M/326 € 1.440,00 1 066000326

6600 M/327

assortimento 101 utensili,
con ganci senza pannello



6600 M/327 € 1.180,00 1 066000327

6600 M/330

assortimento 110 utensili,
con ganci senza pannello

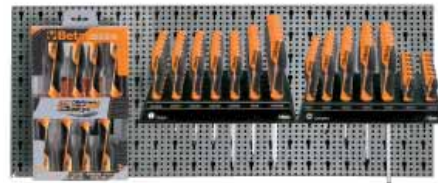

6600 M/330 € 969,00 1 066000330

6600 M/371

assortimento 162 utensili,
con ganci senza pannello



6600 M/371 € 1.169,00 1 066000371

6600 M/380

assortimento 71 utensili,
con ganci senza pannello



6600 M/380 € 751,00 1 066000380

6600 M/406

assortimento 107 utensili,
con ganci senza pannello

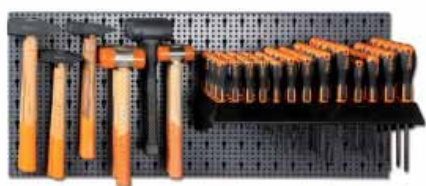

6600 M/406 € 1.260,00 1 066000406

6600 M/417

assortimento 43 utensili,
con ganci senza pannello



6600 M/417 € 1.091,00 1 066000417

6600 M/423

assortimento 29 utensili, con ganci senza pannello



6600 M/423 € 1.083,00 1 066000423

6600 M/424

assortimento 36 utensili, con ganci senza pannello



6600 M/424 € 1.152,00 1 066000424

6600 M/427

assortimento 24 utensili,
con ganci senza pannello



6600 M/427 € 1.176,00 1 066000427

6600 M/430

assortimento 29 utensili,
con ganci senza pannello



6600 M/430 € 1.148,00 1 066000430

6600 M/440

assortimento 140 utensili,
con ganci senza pannello

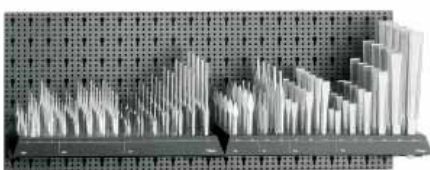

6600 M/440 € 2.170,00 1 066000440

6600 M/456

assortimento di 41 utensili,
con ganci senza pannello



6600 M/456 € 1.655,00 1 066000456

6600 M/465

assortimento 36 utensili, con ganci senza pannello



6600 M/465 € 1.990,00 1 066000465

6600 M/480

assortimento 18 utensili,
con ganci senza pannello



6600 M/480 € 1.255,00 1 066000480

6600 M/485

assortimento 12 utensili,
con ganci senza pannello



6600 M/485 € 904,00 1 066000485

6600 M/510

assortimento 16 utensili,
con ganci senza pannello



6600 M/510 € 1.245,00 1 066000510

6600 M/532

assortimento di 24 utensili
con ganci senza pannello



6600 M/532 € 1.016,00 1 066000532

6600 M/534

assortimento 51 utensili,
con ganci senza pannello



6600 M/534 € 1.625,00 1 066000534

6600 M/542

assortimento di 53 utensili,
con ganci senza pannello



6600 M/542 € 1.009,00 1 066000542

6600 M/548

assortimento di 37 utensili,
con ganci senza pannello



6600 M/548 € 921,00 1 066000548

6600 M/561

assortimento 60 utensili,
con ganci senza pannello



6600 M/561 € 1.325,00 1 066000561

6600 M/583

assortimento di 22 utensili
con ganci senza pannello



6600 M/583 € 924,00 1 066000583

6600 M/643

assortimento 90 utensili,
con ganci senza pannello



6600 M/643 € 2.225,00 1 066000643

6600 M/650

assortimento 28 utensili,
con ganci senza pannello

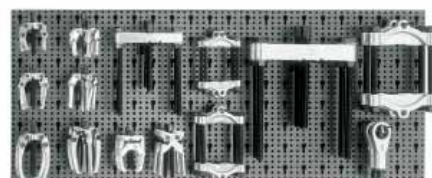

6600 M/650 € 2.720,00 1 066000650

6600 M/657

assortimento 17 utensili,
con ganci senza pannello

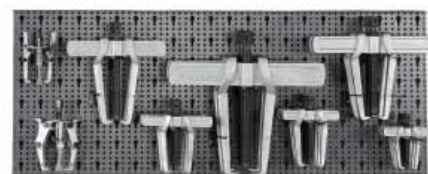

6600 M/657 € 2.205,00 1 066000657

6600 M/658

assortimento di 14 utensili
con ganci senza pannello

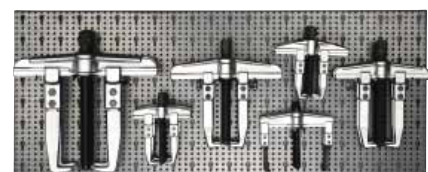

6600 M/658 € 2.465,00 1 066000658



6600 M/716

assortimento 64 utensili,
con ganci senza pannello



6600 M/716 € 2.740,00 1 066000716

6600 M/813

assortimento 25 utensili, con ganci senza
pannello



6600 M/813 € 1.255,00 1 066000813

6600 M/842

assortimento 36 utensili, con ganci senza
pannello



6600 M/842 € 1.630,00 1 066000842

6600 M/852

assortimento di 560 dischi abrasivi rigidi
con ganci senza pannello



6600 M/852 € 1.575,00 1 066000852

6600 M/856

assortimento di 560 dischi abrasivi rigidi
con ganci senza pannello



6600 M/856 € 1.655,00 1 066000856

6600 M/857

assortimento di 560 dischi abrasivi rigidi
con ganci senza pannello



6600 M/857 € 1.740,00 1 066000857

6600 M/871

assortimento di 120 dischi abrasivi lamellari
con ganci senza pannello



6600 M/871 € 706,00 1 066000871

6600 M/878

assortimento di 100 dischi abrasivi lamellari
con ganci senza pannello



6600 M/878 € 663,00 1 066000878

6600 M/881

assortimento di 410 ruote abrasive con gambo
con vasca espositiva



6600 M/881 € 1.960,00 1 066000881

Robur

8600 R/11

assortimento 374 accessori per funi,
con ganci senza pannello

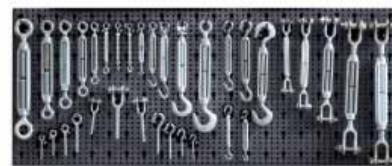

8600 R/11 € 1.725,00 1 086000011

8600 R/12

assortimento 259 accessori per funi,
con ganci senza pannello

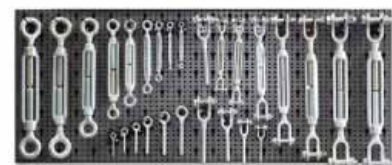

8600 R/12 € 1.685,00 1 086000012

6600 M/871 € 706,00 1 066000871



8600 R/13

assortimento 230 accessori per funi,
con ganci senza pannello



8600 R/13 € 1.425,00 1 086000013

8600 R/113

assortimento 1862 accessori per funi,
con ganci senza pannello



8600 R/113 € 1.990,00 1 086000113

8600 R/114

assortimento 1045 accessori per funi,
con ganci senza pannello



8600 R/114 € 1.960,00 1 086000114

8600 R/225

assortimento 64 accessori GRADO 8
con ganci senza pannello



8600 R/225 € 1.340,00 1 086000225

8600 R/412

assortimento 348 accessori INOX per funi,
con ganci senza pannello

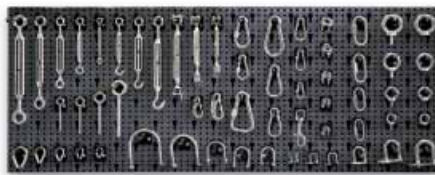

8600 R/412 € 1.975,00 1 086000412

8600 R/511

assortimento 11 bobine catena genovese
con vasca espositiva

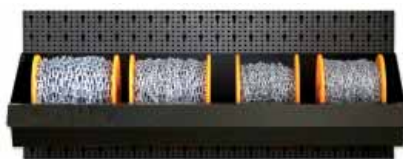

8600 R/511 € 1.645,00 1 086000511

8600 R/601

assortimento 50 cricchetti di ancoraggio
con griglie, ripiano e ganci
senza pannello



8600 R/601 € 1.087,00 1 086000601
C88/R601 € 322,00 1 088000160

8600 R/611

assortimento 52 fasce di sollevamento
con griglie, senza pannello



8600 R/611 € 860,00 1 086000611
C88/R611 € 188,00 1 088000161

Beta

CALZATURE ANTINFORTUNISTICHE

LEGENDA



Presenza lamina antiperforazione



Resistente alle flessioni ripetute > 60.000



Presenza puntale di protezione



Suola resistente al calore per contatto (300°C/min.)



Calzatura antistatica



Calzatura amagnetica, totalmente priva di componenti metallici



Assorbimento di energia nella zona del tallone



Calzatura sviluppata per assicurare la costante dissipazione delle cariche elettrostatiche dal corpo al suolo



Suola resistente agli olii, idrocarburi e solventi



Calzatura con ampia calzata (11) per garantire maggiore comfort



Suola antiscivolo



Calzatura sviluppata per garantire l'isolamento dal freddo (-20°C)

AVVERTENZE

Verificare prima dell'impiego che la calzatura corrisponda alle proprie esigenze di utilizzo e che la categoria di protezione sia corretta in funzione al tipo e al luogo di lavoro. Le calzature prodotte da Beta Utensili sono conformi alle NORMATIVE EUROPEE vigenti. La legge responsabilizza il datore di lavoro per quanto riguarda l'adeguatezza del DPI al tipo di rischio presente (caratteristica del DPI e categoria di appartenenza).

OBSOLESCENZA

A causa dei numerosi fattori (umidità durante l'immagazzinamento e modificazione della struttura dei materiali nel tempo) non è possibile stabilire con certezza la durata di immagazzinamento della scarpa. In generale, per calzature interamente in poliuretano o con fondo in poliuretano è comunque ipotizzabile una durata massima di **tre anni** dalla data di produzione. Per calzature **interamente in PVC** è ipotizzabile una durata di **cinque anni** dalla data di produzione, mentre per **calzature con tomaia in cuoio, calzature in gomma, materiale termoplastico e EVA** è ipotizzabile una durata massima di **dieci anni** dalla data di produzione. Tale termine si intende per calzature nuove, imballate e conservate in condizioni controllate, evitando forti escursioni termiche e di umidità relativa.

NORMATIVE EUROPEE

EN ISO 20345:2011 - EN ISO 20347:2012

CONFORMITÀ ALLA NORMATIVA EN ISO 20345:2011

La norma specifica i requisiti di base e supplementari (facoltativi) per le **calzature di Sicurezza** per usi generali. Le calzature conformi alla normativa EN ISO 20345:2011 sono contraddistinte dalla lettera **"S"** (Safety = Sicurezza) con resistenza del puntale a 200 Joule.

CONFORMITÀ ALLA NORMATIVA EN ISO 20347:2012

La norma specifica i requisiti di base e supplementari (facoltativi) per le **calzature da lavoro che non sono esposte a rischi meccanici** (urto o compressione). Le calzature conformi alla normativa EN ISO 20347:2012 sono contraddistinte dalla lettera **"O"** (Occupational = Professionale). Sono simili per caratteristiche alle calzature precedentemente indicate, le uniche differenze sono la mancanza del puntale di protezione e della lamina antiperforazione.

Oltre ai requisiti di base obbligatori secondo la norma EN ISO 20345:2011, le calzature possono soddisfare anche **requisiti aggiuntivi**. Tali requisiti devono essere identificati con simboli o classi e indicati sull'etichetta applicata alla linguetta della calzatura.

NUOVE NORMATIVE EUROPEE

EN ISO 20345:2022 - EN ISO 20347:2022

CONFORMITÀ ALLA NORMATIVA EN ISO 20345:2022

La norma specifica i requisiti di base e supplementari (facoltativi) per le **calzature di Sicurezza** per usi generali. Le calzature conformi alla normativa EN ISO 20345:2022 sono contraddistinte dalla lettera **"S"** (Safety = Sicurezza), sono munite di puntale atto a fornire una protezione contro gli urti di almeno 200 J e contro la compressione di almeno 15 kN.

CONFORMITÀ ALLA NORMATIVA EN ISO 20347:2022

La norma specifica i requisiti di base e supplementari (facoltativi) per le **calzature da lavoro che non sono esposte a rischi meccanici** (urto o compressione). Le calzature conformi alla normativa EN ISO 20347:2022 sono contraddistinte dalla lettera **"O"** (Occupational = Professionale). Sono simili per caratteristiche alle calzature precedentemente indicate, le uniche differenze sono la mancanza del puntale di protezione e della lamina antiperforazione.

Oltre ai requisiti di base obbligatori secondo la norma EN ISO 20345:2022, le calzature possono soddisfare anche **requisiti aggiuntivi**. Tali requisiti devono essere identificati con simboli o classi e indicati sulla calzatura.

Informazioni per calzature con inserto anti-perforazione

La resistenza alla perforazione della calzatura è misurata in laboratorio utilizzando chiodi e forza standardizzati. Chiodi di diametro inferiore e carichi statici o dinamici più elevati aumentano il rischio di perforazione. In tali circostanze, è necessario prendere in considerazione ulteriori misure preventive. Attualmente nelle calzature DPI sono disponibili tre diversi tipi di inserti resistenti alla perforazione. Essi possono essere inserti in metallo e inserti non metallici e devono essere scelti sulla base di una valutazione dei rischi legati al tipo lavoro. Tutti gli inserti offrono protezione contro il rischio di perforazione, ma ciascuno di essi presenta diversi vantaggi o svantaggi aggiuntivi, tra cui i seguenti:

- **Inserto anti-perforazione metallico:** la resistenza alla perforazione risente meno della forma dell'oggetto tagliente (ad esempio il diametro, la geometria o la forma appuntita), ma a causa di limitazioni nelle dimensioni necessarie per la produzione delle calzature, esso non copre l'intera superficie della parte inferiore della scarpa.
- **Inserto anti-perforazione non metallico:** può essere più leggero, più flessibile e fornire una maggiore area di copertura se confrontato con quello metallico, ma la resistenza alla perforazione può variare maggiormente a seconda della forma dell'oggetto tagliente (ad esempio il diametro, la geometria o la forma appuntita). Sono disponibili due tipi di protezione. Il tipo PS può offrire una protezione più adeguata da oggetti di diametro inferiore rispetto al tipo PL.

CLASSIFICAZIONE CALZATURE

- **Classe I:** Calzature in cuoio e altri materiali, escluso calzature interamente di gomma e le calzature interamente di materiale polimerico.
- **Classe II:** Calzature interamente in gomma (cioè interamente vulcanizzate) o interamente di materiale polimerico (cioè interamente iniettate).

REQUISITI DI BASE

- **Calzatura completa:** altezza del tomaio; zona del tallone; prestazioni costruttive della suola (costruzione e resistenza al distacco tomaio/ suola); protezione delle dita e caratteristiche del puntale (eccetto EN ISO 20347), proprietà antiscivolo.
- **Tomaia:** caratteristiche dei materiali del tomaio, fodera, linguetta, sottopiede (resistenza allo strappo, all'abrasione, caratteristiche di trazione, permeabilità al vapore acqueo, pH, assorbimento e deassorbimento per il sottopiede e per il plantare).
- **Suola:** costruzione e resistenze allo strappo, all'abrasione, alla flessione, all'idrolisi, al distacco strati della suola e agli olii idrocarburi.

CLASSE DI PROTEZIONE	EN ISO 20345:2011				EN ISO 20347:2012				EN ISO 20345:2011		EN ISO 20347:2012		VALORI MINIMI RICHIESTI	
	SB	S1	S2	S3	OB	O1	O2	O3	S4	S5	O4	O5		
	Zona del tallone chiusa	0	X	X	X	0	X	X	X	X	X	X	X	
	Resistenza all'urto del puntale 200 Joule	X	X	X	X	-	-	-	-	X	X	-	-	
A	Calzatura antistatica	0	X	X	X	0	X	X	X	X	X	X	X	Resistenza elettrica > 100 kΩ, ≤ 1000 MΩ
E	Assorbimento di energia nella zona tallone	0	X	X	X	0	X	X	X	X	X	X	X	> 20 Joule
WRU	Penetrazione e assorbimento dell'acqua nel tomaio	0	-	X	X	0	-	X	X	-	-	-	-	Penetrazione: < 0.2 g x 60 min Assorbimento: < 30% x 60 min.
P	Resistenza della suola alla perforazione	0	0	-	X	0	0	-	X	0	X	0	X	> 1100 N
CI	Isolamento dal freddo	0	0	0	0	0	0	0	0	0	0	0	0	Riduzione temp. superficie interna suola: < 10°C
HI	Isolamento dal calore	0	0	0	0	0	0	0	0	0	0	0	0	Aumento temp. superficie interna suola: < 22°C
HRO	Resistenza della suola al calore per contatto	0	0	0	0	0	0	0	0	0	0	0	0	Resistente fino a 300°C
WR	Calzatura resistente all'acqua	0	0	0	0	0	0	0	0	-	-	-	-	Assorbimento: < 3 cm ²
FO	Resistenza della suola agli idrocarburi	0	X	X	X	0	0	0	0	X	X	0	0	Aumento volume della suola < 12%
SRC	Resistenza della suola allo scivolamento	X	X	X	X	X	X	X	X					Requisito SRA + SRB

X	Requisito obbligatorio della categoria di protezione
O	Requisito facoltativo unito a quelli obbligatori, se indicato nella marcatura
-	Requisito non obbligatorio , controllare marcatura scarpa

Calzature antistatiche:

Le calzature antistatiche vanno utilizzate quando sussiste la necessità di ridurre al minimo l'accumulo di cariche elettrostatiche in modo da escludere il pericolo di combustione di sostanze infiammabili e vapori e nel caso in cui persista il rischio di scosse elettriche provenienti da elementi sotto tensione. Le calzature antistatiche non forniscono una protezione contro lo shock elettrico in quanto creano unicamente una resistenza elettrica tra il pavimento e il piede. Qualora non si possa escludere completamente il pericolo di uno shock elettrico, si dovrà ricorrere a precauzioni aggiuntive che dovrebbero fare parte di un programma periodico di prevenzione degli infortuni sul posto di lavoro. Al fine di preservare i requisiti di antistaticità, le calzature non dovranno subire modifiche.

Calzature elettricamente isolanti:

Le calzature elettricamente isolate forniscono protezione limitata elettrica da contatti accidentali con tensioni fino a 1000 V con la riserva che le condizioni di impiego dovranno essere tali da non modificare o alterare la resistenza elettrica con l'influenza dell'umidità. Va specificato che la resistenza elettrica è riferita solamente al fondo della calzatura e non al tomaio.

Classi elettriche calzature:

Classe 00 500V CA oppure 750V CC

Classe 0 1000V CA oppure 1500V CC

Calzature dissipative per ambienti EPA:

Le calzature dissipative sono specifiche per ambienti EPA (ESDS) e permettono alle cariche elettrostatiche presenti sul corpo di chi le indossa di essere dissipate in modo continuo e controllato, in modo da proteggere i componenti e i dispositivi elettronici dai fenomeni elettrostatici. Il valore di riferimento della resistenza al suolo secondo CEI EN 61340-5-1: 2016, per chi lo indossa / calzature / pavimento, è tra < 1 × 10⁹ Ω.

CLASSIFICAZIONE CALZATURE

- **Classe I:** Calzature in cuoio e altri materiali, escluso calzature interamente di gomma e le calzature interamente di materiale polimerico.
- **Classe II:** Calzature interamente in gomma (cioè interamente vulcanizzate) o interamente di materiale polimerico (cioè interamente inietate).

REQUISITI DI BASE

- **Calzatura completa:** altezza del tomaio; zona del tallone; prestazioni costruttive della suola (costruzione e resistenza al distacco tomaio/ suola); protezione delle dita e caratteristiche del puntale (eccetto EN ISO 20347), proprietà antiscivolo.
- **Tomaia:** caratteristiche dei materiali del tomaio, fodera, linguetta, sottopiede (resistenza allo strappo, all'abrasione, caratteristiche di trazione, permeabilità al vapore acqueo, pH, assorbimento e deassorbimento per il sottopiede e per il plantare).
- **Suola:** costruzione e resistenze allo strappo, all'abrasione, alla flessione, all'idrolisi, al distacco strati della suola e agli olii idrocarburi.

CLASSE DI PROTEZIONE	EN ISO 20345:2022											EN ISO 20347:2022						VALORI MINIMI RICHIESTI
	SB	S1	S2	S3	S3L	S3S	S6	S7	S7L	S7S	OB	O1	O2	O3	O3L	O3S		
Classe	I o II	I	I	I	I	I	I	I	I	I	I o II	I	I	I	I	I		
Zona del tallone chiusa	0	X	X	X	X	X	X	X	X	X	0	X	X	X	X	X		
Resistenza all'urto del puntale 200 Joule	X	X	X	X	X	X	X	X	X	X	-	-	-	-	-	-		
Suola tassellata	0	0	0	X	X	X	0	X	X	X	0	0	0	X	X	X		
P Resistenza alla perforazione (inserto metallico P)	0	0	0	X	-	-	0	X	-	-	0	0	0	X	-	-	Forza di perforazione ≥ 1100N	
PL Resistenza alla perforazione (inserto non-metallico, prova con chiodo Ø 4,5 mm)	0	0	0	-	X	-	0	-	X	-	0	0	0	-	X	-		
PS Resistenza alla perforazione (inserto non-metallico, prova con chiodo Ø 3,0 mm)	0	0	0	-	-	X	0	-	-	X	0	0	0	-	-	X		
A Calzature antistatiche	0	X	X	X	X	X	X	X	X	X	0	X	X	X	X	X	Resistenza elettrica > 100 kΩ ≤ 1000 kΩ	
HI Isolamento dal calore del complesso soletta	0	0	0	0	0	0	0	0	0	0	0	0	0	0	0	0	Incremento T ≤ 22°C quando appoggiata su piastra alla T di 150°C per 30'	
CI Isolamento dal freddo del complesso soletta	0	0	0	0	0	0	0	0	0	0	0	0	0	0	0	0	Decremento T ≤ 10°C in ambiente a -17°C per 30'	
E Assorbimento di energia nella zona del tallone	0	X	X	X	X	X	X	X	X	X	0	X	X	X	X	X	> 20 Joule	
WR Resistenza all'acqua	0	0	0	0	0	0	X	X	X	X	0	0	0	0	0	0	Nessuna penetrazione dell'acqua	
SC Resistenza all'abrasione del copri punta	0	0	0	0	0	0	0	0	0	0	0	0	0	0	0	0	Nessun foro per tutto lo spessore dopo 8.000 cicli	
SR Resistenza allo scivolamento su pavimento in ceramica con glicerina	X	X	X	X	X	X	X	X	X	X	X	X	X	X	X	X	Prova su piano in ceramica con glicerina.	
WPA Penetrazione ed assorbimento di acqua	0	0	X	X	X	X	-	-	-	-	0	0	X	X	X	X	Assorbimento H2O dopo 60' ≤ 30%	
HRO Resistenza al calore per contatto	0	0	0	0	0	0	0	0	0	0	0	0	0	0	0	0	Contatto a 300°C per 60" - non fonde	
FO Resistenza agli idrocarburi	0	0	0	0	0	0	0	0	0	0	0	0	0	0	0	0	Incremento di volume del campione di suola < 12 %	
LG Grip sulla scala	0	0	0	0	0	0	0	0	0	0	0	0	0	0	0	0	Larghezza zona centrale della suola > 35 mm	

X	Requisito obbligatorio della categoria di protezione
O	Requisito facoltativo unito a quelli obbligatori, se indicato nella marcatura
-	Requisito non obbligatorio , controllare marcatura scarpa

Calzature parzialmente conduttive

Le calzature parzialmente conduttive devono essere utilizzate se è necessario ridurre al minimo le cariche elettrostatiche nel più breve tempo possibile, ad esempio durante la manipolazione di esplosivi.

Non devono essere utilizzate se non è stato completamente eliminato il rischio di scosse da apparecchiature elettriche o parti sotto tensione con tensione alternata o continua. Per garantire che questa calzatura sia parzialmente conduttiva, è stato specificato che il limite superiore di resistenza è di 100 kΩ nel suo nuovo stato.

Calzature antistatiche

Le calzature antistatiche vanno utilizzate quando sussiste la necessità di ridurre al minimo l'accumulo di cariche elettrostatiche in modo da escludere il pericolo di combustione di sostanze infiammabili e vapori e nel caso in cui persista il rischio di scosse elettriche provenienti da elementi sotto tensione. Le calzature antistatiche non forniscono una protezione contro lo shock elettrico in quanto creano unicamente una resistenza elettrica tra il pavimento e il piede. Qualora non si possa escludere completamente il pericolo di uno shock elettrico, si dovrà ricorrere a precauzioni aggiuntive che dovrebbero fare parte di un programma periodico di prevenzione degli infortuni sul posto di lavoro.

Al fine di preservare i requisiti di antistaticità, le calzature non dovranno subire modifiche.

NB Tutte le calzature certificate con la vecchia normativa mantengono la validità del certificato fino alla scadenza dello stesso.

EN ISO 20345:2011		S1P SRC										
LINEA	ARTICOLO	REQUISITI					SETTORI CONSIGLIATI					📄
		REQUISITI SUPPLEMENTARI		METAL FREE	AUTOMOTIVE	EDILIZIA	ELETTRICITÀ	INDUSTRIA	LOGISTICA SERVIZI	TERMOIDRAULICA		
	7212G	ESD	X	X	X	X	X	X	X	X	635	
	7212B	ESD	X	X	X	X	X	X	X	634		
	7213G	ESD	X	X	X	X	X	X	X	635		
	7222PEK		X	X	X	X	X	X	X	633		
	7223PEK		X	X	X	X	X	X	X	633		
	7241BK			X	X	X	X	X	X	630		
	7243BK			X	X	X	X	X	X	630		
	7246BK			X	X	X	X	X	X	632		
	7247BK			X	X	X	X	X	X	632		
	7246E			X	X	X	X	X	629			
	7249GK	RS		X	X	X	X	X	X	638		
	7314AF		X	X	X	X	X	X	X	639		
	7316NB	ESD	X	X	X	X	X	X	X	639		
	7316NG	ESD	X	X	X	X	X	X	X	640		
	7317NA		X	X	X	X	X	X	X	640		
	7352A	HRO	X	X	X	X	X	X	X	642		
	7352B	HRO	X	X	X	X	X	X	X	642		
	7352G	HRO ESD	X	X	X	X	X	X	X	642		
	7353Y	HRO		X	X	X	X	X	X	643		
	7372B	HRO	X	X	X	X	X	X	X	646		
	7376A	HRO	X	X	X	X	X	X	X	646		
	7352LG	HRO	X	X	X	X	X	X	643			

EN ISO 20347:2012		O1 SRC									
	7362B	FO HRO	X	X	X	X	X	X	X	X	645

EN ISO 20345:2022		S1PS SR									
	7371V	HRO FO ESD	X	X	X	X	X	X	X	X	645

EN ISO 20347:2012		O2 SRC									
	7243FT	FO		X	X	X	X	X	X	X	631
	7363N	FO HRO	X	X	X	X	X	X	X	X	645

EN ISO 20345:2011		S3 SRC										
LINEA	ARTICOLO	REQUISITI					SETTORI CONSIGLIATI					📄
		REQUISITI SUPPLEMENTARI		METAL FREE	AGRICOLTURA	AUTOMOTIVE	EDILIZIA	INDUSTRIA	ELETTRICITÀ	LOGISTICA SERVIZI	OIL & GAS	
	7214FN		X	X	X	X	X	X	X	X	635	
	7214G	ESD	X	X	X	X	X	X	X	X	636	
	7215FN		X	X	X	X	X	X	X	X	636	
	7218FN	RS	X	X	X	X	X	X	X	X	636	
	7218G	RS ESD	X	X	X	X	X	X	X	X	636	
	7220PEK		X	X	X	X	X	X	X	X	633	
	7221PEK	RS	X	X	X	X	X	X	X	X	633	
	7236BK	RS		X	X	X	X	X	X	X	638	
	7238WR	RS HRO WR		X	X	X	X	X	X	X	638	
	7241EN			X	X	X	X	X	X	X	629	
	7243EN	RS		X	X	X	X	X	X	X	629	
	7241CK			X	X	X	X	X	X	X	630	
	7243CK	RS		X	X	X	X	X	X	X	631	
	7243CR	RS HRO		X	X	X	X	X	X	X	631	
	7245BK	RS		X	X	X	X	X	X	X	631	
	7293HM	HRO HI	X	X	X	X	X	X	X	X	647	
	7294HM	HRO HI	X	X	X	X	X	X	X	X	647	
	7294HMC	HRO HI CI WR	X	X	X	X	X	X	X	X	647	
	7315AN		X	X	X	X	X	X	X	X	639	
	7318AN		X	X	X	X	X	X	X	X	640	
	7320NA		X	X	X	X	X	X	X	X	640	
	7321NA	RS	X	X	X	X	X	X	X	X	641	
	7322SA		X	X	X	X	X	X	X	X	641	
	7323SA	RS	X	X	X	X	X	X	X	X	641	
	7354N	HRO	X	X	X	X	X	X	X	X	643	
	7355V	HRO	X	X	X	X	X	X	X	X	643	
	7356G	HRO	X	X	X	X	X	X	X	X	644	
	7357G	HRO	X	X	X	X	X	X	X	X	644	
	7356V	HRO	X	X	X	X	X	X	X	X	644	
	7357V	HRO	X	X	X	X	X	X	X	X	645	
	7356LN	HRO	X	X	X	X	X	X	X	644		
	7381N	HRO WR	X	X	X	X	X	X	X	X	646	
	7382N	HRO WR	X	X	X	X	X	X	X	X	646	

EN ISO 20345:2011		S5 SRC									
	7328A			X	X	X	X	X	X	X	632
	7328N			X	X	X	X	X	X	X	632

EASY



7241EN

scarpe in pelle idrorepellente

- Puntale in acciaio
- Lamina antiperforazione in acciaio elastico

**EN ISO
20345
2011**

EU	UK	mm	€		
35	2,5	230	40,00	1	072410835
36	3,5	237	40,00	1	072410836
37	4,5	244	40,00	1	072410837
38	5	250	40,00	1	072410838
39	6	257	40,00	1	072410839
40	6,5	264	40,00	1	072410840
41	7	270	40,00	1	072410841
42	8	277	40,00	1	072410842
43	9	284	40,00	1	072410843
44	10	290	40,00	1	072410844
45	10,5	297	40,00	1	072410845
46	11	304	40,00	1	072410846
47	12	310	40,00	1	072410847
48	13	317	40,00	1	072410848

CE



S3 SRC



7243EN

scarpe alte in pelle idrorepellente
con rapido sfilamento

- Puntale in acciaio
- Lamina antiperforazione in acciaio elastico

**EN ISO
20345
2011**

EU	UK	mm	€		
35	2,5	230	41,00	1	072430835
36	3,5	237	41,00	1	072430836
37	4,5	244	41,00	1	072430837
38	5	250	41,00	1	072430838
39	6	257	41,00	1	072430839
40	6,5	264	41,00	1	072430840
41	7	270	41,00	1	072430841
42	8	277	41,00	1	072430842
43	9	284	41,00	1	072430843
44	10	290	41,00	1	072430844
45	10,5	297	41,00	1	072430845
46	11	304	41,00	1	072430846
47	12	310	41,00	1	072430847
48	13	317	41,00	1	072430848

CE



S3 RS SRC



7246E

scarpe basse in pelle scamosciata traforata

- Puntale in acciaio
- Lamina antiperforazione in acciaio elastico

**EN ISO
20345
2011**

EU	UK	mm	€		
35	2,5	230	41,00	1	072460435
36	3,5	237	41,00	1	072460436
37	4,5	244	41,00	1	072460437
38	5	250	41,00	1	072460438
39	6	257	41,00	1	072460439
40	6,5	264	41,00	1	072460440
41	7	270	41,00	1	072460441
42	8	277	41,00	1	072460442
43	9	284	41,00	1	072460443
44	10	290	41,00	1	072460444
45	10,5	297	41,00	1	072460445
46	11	304	41,00	1	072460446
47	12	310	41,00	1	072460447
48	13	317	41,00	1	072460448

CE



S1P SRC



BASIC



7241BK

scarpe in pelle

- Punta in acciaio
- Lamina antiperforazione in fibra composita

**EN ISO
20345
2011**

EU	UK	mm	€		
35	2,5	228	48,00	1	072411235
36	3,5	235	48,00	1	072411236
37	4,5	242	48,00	1	072411237
38	5	248	48,00	1	072411238
39	6	255	48,00	1	072411239
40	6,5	262	48,00	1	072411240
41	7	268	48,00	1	072411241
42	8	275	48,00	1	072411242
43	9	282	48,00	1	072411243
44	10	288	48,00	1	072411244
45	10,5	295	48,00	1	072411245
46	11	302	48,00	1	072411246
47	12	308	48,00	1	072411247
48	13	315	48,00	1	072411248



CE

S1P SRC



7241CK

scarpe in pelle idrorepellente

- Punta in acciaio
- Lamina antiperforazione in fibra composita

**EN ISO
20345
2011**

EU	UK	mm	€		
35	2,5	228	49,00	1	072411535
36	3,5	235	49,00	1	072411536
37	4,5	242	49,00	1	072411537
38	5	248	49,00	1	072411538
39	6	255	49,00	1	072411539
40	6,5	262	49,00	1	072411540
41	7	268	49,00	1	072411541
42	8	275	49,00	1	072411542
43	9	282	49,00	1	072411543
44	10	288	49,00	1	072411544
45	10,5	295	49,00	1	072411545
46	11	302	49,00	1	072411546
47	12	308	49,00	1	072411547
48	13	315	49,00	1	072411548



CE

S3 SRC



7243BK

scarpe alte in pelle

- Punta in acciaio
- Lamina antiperforazione in fibra composita

**EN ISO
20345
2011**

EU	UK	mm	€		
35	2,5	228	49,00	1	072431235
36	3,5	235	49,00	1	072431236
37	4,5	242	49,00	1	072431237
38	5	248	49,00	1	072431238
39	6	255	49,00	1	072431239
40	6,5	262	49,00	1	072431240
41	7	268	49,00	1	072431241
42	8	275	49,00	1	072431242
43	9	282	49,00	1	072431243
44	10	288	49,00	1	072431244
45	10,5	295	49,00	1	072431245
46	11	302	49,00	1	072431246
47	12	308	49,00	1	072431247
48	13	315	49,00	1	072431248



CE

S1P SRC



7243CK

scarpe alte in pelle idrorepellente
con rapido sfilamento

- Puntale in acciaio
- Lamina antiperforazione in fibra composita

EU	UK	mm	€		
35	2,5	228	50,50	1	072431335
36	3,5	235	50,50	1	072431336
37	4,5	242	50,50	1	072431337
38	5	248	50,50	1	072431338
39	6	255	50,50	1	072431339
40	6,5	262	50,50	1	072431340
41	7	268	50,50	1	072431341
42	8	275	50,50	1	072431342
43	9	282	50,50	1	072431343
44	10	288	50,50	1	072431344
45	10,5	295	50,50	1	072431345
46	11	302	50,50	1	072431346
47	12	308	50,50	1	072431347
48	13	315	50,50	1	072431348



CE

S3 RS SRC

EN ISO
20345
2011



7243CR

scarpe alte in pelle idrorepellente
con suola in gomma ad alta resistenza
e rapido sfilamento

- Puntale in acciaio
- Lamina antiperforazione in acciaio elastico

EU	UK	mm	€		
35	2,5	231	74,50	1	072430735
36	3,5	238	74,50	1	072430736
37	4,5	245	74,50	1	072430737
38	5	251	74,50	1	072430738
39	6	258	74,50	1	072430739
40	6,5	265	74,50	1	072430740
41	7	271	74,50	1	072430741
42	8	278	74,50	1	072430742
43	9	285	74,50	1	072430743
44	10	291	74,50	1	072430744
45	10,5	298	74,50	1	072430745
46	11	305	74,50	1	072430746
47	12	311	74,50	1	072430747
48	13	318	74,50	1	072430748



CE

S3 RS HRO SRC

EN ISO
20345
2011



7243FT

scarpe alte in pelle idrorepellente
senza puntale e lamina antiperforazione

- Senza puntale
- Senza lamina antiperforazione

EU	UK	mm	€		
35	2,5	228	44,00	1	072430635
36	3,5	235	44,00	1	072430636
37	4,5	242	44,00	1	072430637
38	5	248	44,00	1	072430638
39	6	255	44,00	1	072430639
40	6,5	262	44,00	1	072430640
41	7	268	44,00	1	072430641
42	8	275	44,00	1	072430642
43	9	282	44,00	1	072430643
44	10	288	44,00	1	072430644
45	10,5	295	44,00	1	072430645
46	11	302	44,00	1	072430646
47	12	308	44,00	1	072430647
48	13	315	44,00	1	072430648



CE

O2 FO SRC

EN ISO
20347
2012



7245BK

scarpe alte "saldatore" stringate in pelle idrorepellente con
rapido sfilamento
e protezione frontale con chiusura a strappo

- Puntale in acciaio
- Lamina antiperforazione in fibra composita

EU	UK	mm	€		
35	2,5	228	58,00	1	072451235
36	3,5	235	58,00	1	072451236
37	4,5	242	58,00	1	072451237
38	5	248	58,00	1	072451238
39	6	255	58,00	1	072451239
40	6,5	262	58,00	1	072451240
41	7	268	58,00	1	072451241
42	8	275	58,00	1	072451242
43	9	282	58,00	1	072451243
44	10	288	58,00	1	072451244
45	10,5	295	58,00	1	072451245
46	11	302	58,00	1	072451246
47	12	308	58,00	1	072451247
48	13	315	58,00	1	072451248



CE

S3 RS SRC

EN ISO
20345
2011



7246BK
scarpe in pelle scamosciata traforata

- Punta in acciaio
- Lamina antiperforazione in fibra composita

EU	UK	mm	€		
35	2,5	228	50,50	1	072461235
36	3,5	235	50,50	1	072461236
37	4,5	242	50,50	1	072461237
38	5	248	50,50	1	072461238
39	6	255	50,50	1	072461239
40	6,5	262	50,50	1	072461240
41	7	268	50,50	1	072461241
42	8	275	50,50	1	072461242
43	9	282	50,50	1	072461243
44	10	288	50,50	1	072461244
45	10,5	295	50,50	1	072461245
46	11	302	50,50	1	072461246
47	12	308	50,50	1	072461247
48	13	315	50,50	1	072461248



CE

S1P SRC

**EN ISO
20345
2011**



7247BK
sandali in pelle traforata

- Punta in acciaio
- Lamina antiperforazione in fibra composita

EU	UK	mm	€		
35	2,5	228	50,00	1	072471235
36	3,5	235	50,00	1	072471236
37	4,5	242	50,00	1	072471237
38	5	248	50,00	1	072471238
39	6	255	50,00	1	072471239
40	6,5	262	50,00	1	072471240
41	7	268	50,00	1	072471241
42	8	275	50,00	1	072471242
43	9	282	50,00	1	072471243
44	10	288	50,00	1	072471244
45	10,5	295	50,00	1	072471245
46	11	302	50,00	1	072471246
47	12	308	50,00	1	072471247
48	13	315	50,00	1	072471248



CE

S1P SRC

**EN ISO
20345
2011**



7328A
stivali di sicurezza "alta visibilità" in PVC nitrilico.
Con battistrada antiscivolo autopulente.

- Punta in acciaio
- Lamina antiperforazione in acciaio elastico

EU	UK	mm	€		
38	5	253	39,50	1	073280638
39	6	260	39,50	1	073280639
40	6,5	267	39,50	1	073280640
41	7	273	39,50	1	073280641
42	8	280	39,50	1	073280642
43	9	287	39,50	1	073280643
44	10	293	39,50	1	073280644
45	10,5	300	39,50	1	073280645
46	11	307	39,50	1	073280646
47	12	313	39,50	1	073280647



CE

S5 SRC

**EN ISO
20345
2011**



7328N
stivali di sicurezza in PVC nitrilico.
Con battistrada antiscivolo autopulente.

- Punta in acciaio
- Lamina antiperforazione in acciaio elastico

EU	UK	mm	€		
38	5	253	39,50	1	073280838
39	6	260	39,50	1	073280839
40	6,5	267	39,50	1	073280840
41	7	273	39,50	1	073280841
42	8	280	39,50	1	073280842
43	9	287	39,50	1	073280843
44	10	293	39,50	1	073280844
45	10,5	300	39,50	1	073280845
46	11	307	39,50	1	073280846
47	12	313	39,50	1	073280847



CE

S5 SRC

**EN ISO
20345
2011**



EASY PLUS



7220PEK

scarpe in pelle idrorepellente con inserti in nylon e rinforzo antiabrasione nella zona del puntale

- Puntale in composito
- Lamina antiperforazione in fibra composita

EU	UK	mm	€		
35	2,5	228	66,50	1	072200235
36	3,5	235	66,50	1	072200236
37	4,5	242	66,50	1	072200237
38	5	248	66,50	1	072200238
39	6	255	66,50	1	072200239
40	6,5	262	66,50	1	072200240
41	7	268	66,50	1	072200241
42	8	275	66,50	1	072200242
43	9	282	66,50	1	072200243
44	10	288	66,50	1	072200244
45	10,5	295	66,50	1	072200245
46	11	302	66,50	1	072200246
47	12	308	66,50	1	072200247
48	13	315	66,50	1	072200248

CE



S3 SRC

EN ISO
20345
2011

METAL
FREE



7221PEK

scarpe alte in pelle idrorepellente con inserti in nylon, rinforzo antiabrasione nella zona del puntale e rapido sfilamento

- Puntale in composito
- Lamina antiperforazione in fibra composita

EU	UK	mm	€		
35	2,5	228	69,50	1	072210235
36	3,5	235	69,50	1	072210236
37	4,5	242	69,50	1	072210237
38	5	248	69,50	1	072210238
39	6	255	69,50	1	072210239
40	6,5	262	69,50	1	072210240
41	7	268	69,50	1	072210241
42	8	275	69,50	1	072210242
43	9	282	69,50	1	072210243
44	10	288	69,50	1	072210244
45	10,5	295	69,50	1	072210245
46	11	302	69,50	1	072210246
47	12	308	69,50	1	072210247
48	13	315	69,50	1	072210248

CE



S3 RS SRC

EN ISO
20345
2011

METAL
FREE



7222PEK

scarpe in pelle scamosciata traforata con inserti in mesh ad alta traspirabilità

- Puntale in composito
- Lamina antiperforazione in fibra composita

EU	UK	mm	€		
35	2,5	228	64,00	1	072220135
36	3,5	235	64,00	1	072220136
37	4,5	242	64,00	1	072220137
38	5	248	64,00	1	072220138
39	6	255	64,00	1	072220139
40	6,5	262	64,00	1	072220140
41	7	268	64,00	1	072220141
42	8	275	64,00	1	072220142
43	9	282	64,00	1	072220143
44	10	288	64,00	1	072220144
45	10,5	295	64,00	1	072220145
46	11	302	64,00	1	072220146
47	12	308	64,00	1	072220147
48	13	315	64,00	1	072220148

CE



S1P SRC

EN ISO
20345
2011

METAL
FREE



7223PEK

scarpe in pelle scamosciata con inserti in mesh ad alta traspirazione e rinforzo antiabrasione nella zona del puntale

- Puntale in composito
- Lamina antiperforazione in fibra composita

**EN ISO
20345
2011**

METAL
FREE



EU	UK	mm	€		
35	2,5	228	69,00	1	072230135
36	3,5	235	69,00	1	072230136
37	4,5	242	69,00	1	072230137
38	5	248	69,00	1	072230138
39	6	255	69,00	1	072230139
40	6,5	262	69,00	1	072230140
41	7	268	69,00	1	072230141
42	8	275	69,00	1	072230142
43	9	282	69,00	1	072230143
44	10	288	69,00	1	072230144
45	10,5	295	69,00	1	072230145
46	11	302	69,00	1	072230146
47	12	308	69,00	1	072230147
48	13	315	69,00	1	072230148



CE

S1P SRC

FLEX

7212B

scarpe in pelle scamosciata, con inserti in mesh. Con inserto antiabrasione nella zona del puntale. Estremamente flessibili e leggere - peso indicativo misura 42: 490 g

- Puntale in composito
- Lamina antiperforazione in fibra composita

**EN ISO
20345
2011**

ESD

METAL
FREE



EU	UK	mm	€		
35	2,5	228	74,00	1	072120235
36	3,5	235	74,00	1	072120236
37	4,5	242	74,00	1	072120237
38	5	248	74,00	1	072120238
39	6	255	74,00	1	072120239
40	6,5	262	74,00	1	072120240
41	7	268	74,00	1	072120241
42	8	275	74,00	1	072120242
43	9	282	74,00	1	072120243
44	10	288	74,00	1	072120244
45	10,5	295	74,00	1	072120245
46	11	302	74,00	1	072120246
47	12	308	74,00	1	072120247
48	13	315	74,00	1	072120248



CE

S1P SRC ESD

Beta

7212G

scarpe in pelle scamosciata traforata.

Con inserto antiabrasione nella zona del puntale

Estremamente flessibili e leggere - peso indicativo misura 42:

490 g

EU	UK	mm	€		
35	2.5	228	74,00	1	072120335
36	3.5	235	74,00	1	072120336
37	4.5	242	74,00	1	072120337
38	5	248	74,00	1	072120338
39	6	255	74,00	1	072120339
40	6.5	262	74,00	1	072120340
41	7	268	74,00	1	072120341
42	8	275	74,00	1	072120342
43	9	282	74,00	1	072120343
44	10	288	74,00	1	072120344
45	10.5	295	74,00	1	072120345
46	11	302	74,00	1	072120346
47	12	308	74,00	1	072120347
48	13	315	74,00	1	072120348

- Puntale in composito
- Lamina antiperforazione in fibra composita

EN ISO
20345
2011



CE

S1P SRC ESD

7213G

scarpe in pelle scamosciata traforata con inserti in mesh ad alta traspirazione

Estremamente flessibili e leggere - peso indicativo misura 42:

490 g

EU	UK	mm	€		
35	2.5	228	74,00	1	072130135
36	3.5	235	74,00	1	072130136
37	4.5	242	74,00	1	072130137
38	5	248	74,00	1	072130138
39	6	255	74,00	1	072130139
40	6.5	262	74,00	1	072130140
41	7	268	74,00	1	072130141
42	8	275	74,00	1	072130142
43	9	282	74,00	1	072130143
44	10	288	74,00	1	072130144
45	10.5	295	74,00	1	072130145
46	11	302	74,00	1	072130146
47	12	308	74,00	1	072130147
48	13	315	74,00	1	072130148

- Puntale in composito
- Lamina antiperforazione in fibra composita

EN ISO
20345
2011



CE

S1P SRC ESD

7214FN

scarpe in action nabuk idrorepellente

con inserto antiabrasione nella zona del puntale

Estremamente flessibili e leggere - peso indicativo misura 42:

500 g

EU	UK	mm	€		
35	2.5	228	80,00	1	072140035
36	3.5	235	80,00	1	072140036
37	4.5	242	80,00	1	072140037
38	5	248	80,00	1	072140038
39	6	255	80,00	1	072140039
40	6.5	262	80,00	1	072140040
41	7	268	80,00	1	072140041
42	8	275	80,00	1	072140042
43	9	282	80,00	1	072140043
44	10	288	80,00	1	072140044
45	10.5	295	80,00	1	072140045
46	11	302	80,00	1	072140046
47	12	308	80,00	1	072140047
48	13	315	80,00	1	072140048

- Puntale in composito
- Lamina antiperforazione in fibra composita

EN ISO
20345
2011



CE

S3 SRC

Beta

7214G

scarpe in action nabuk idrorepellente
con inserto antiabrasione nella zona del puntale
Estremamente flessibili e leggere - peso indicativo misura 42:

500 g

EU	UK	mm	€		
35	2.5	228	80,00	1	072140235
36	3.5	235	80,00	1	072140236
37	4.5	242	80,00	1	072140237
38	5	248	80,00	1	072140238
39	6	255	80,00	1	072140239
40	6.5	262	80,00	1	072140240
41	7	268	80,00	1	072140241
42	8	275	80,00	1	072140242
43	9	282	80,00	1	072140243
44	10	288	80,00	1	072140244
45	10.5	295	80,00	1	072140245
46	11	302	80,00	1	072140246
47	12	308	80,00	1	072140247
48	13	315	80,00	1	072140248

- Puntale in composito
- Lamina antiperforazione in fibra composita



CE



EN ISO
20345
2011



S3 SRC ESD

7215FN

mocassini in action nabuk idrorepellente
con inserto antiabrasione nella zona del puntale
Estremamente flessibili e leggere - peso indicativo misura 42:

490 g

EU	UK	mm	€		
35	2.5	228	81,00	1	072150135
36	3.5	235	81,00	1	072150136
37	4.5	242	81,00	1	072150137
38	5	248	81,00	1	072150138
39	6	255	81,00	1	072150139
40	6.5	262	81,00	1	072150140
41	7	268	81,00	1	072150141
42	8	275	81,00	1	072150142
43	9	282	81,00	1	072150143
44	10	288	81,00	1	072150144
45	10.5	295	81,00	1	072150145
46	11	302	81,00	1	072150146
47	12	308	81,00	1	072150147
48	13	315	81,00	1	072150148

- Puntale in composito
- Lamina antiperforazione in fibra composita



CE



EN ISO
20345
2011



S3 SRC

7218FN

scarpe alte in action nabuk idrorepellente con inserto
antiabrasione nella zona del puntale e rapido sfilamento
Estremamente flessibili e leggere - peso indicativo misura 42:

510 g

EU	UK	mm	€		
35	2.5	228	83,50	1	072180035
36	3.5	235	83,50	1	072180036
37	4.5	242	83,50	1	072180037
38	5	248	83,50	1	072180038
39	6	255	83,50	1	072180039
40	6.5	262	83,50	1	072180040
41	7	268	83,50	1	072180041
42	8	275	83,50	1	072180042
43	9	282	83,50	1	072180043
44	10	288	83,50	1	072180044
45	10.5	295	83,50	1	072180045
46	11	302	83,50	1	072180046
47	12	308	83,50	1	072180047
48	13	315	83,50	1	072180048

- Puntale in composito
- Lamina antiperforazione in fibra composita



CE



EN ISO
20345
2011



S3 RS SRC

7218G

scarpe alte in action nabuk idrorepellente con inserto
antiabrasione nella zona del puntale. Con rapido sfilamento
Estremamente flessibili e leggere - peso indicativo misura 42:

550 g

EU	UK	mm	€		
35	2.5	228	83,50	1	072180135
36	3.5	235	83,50	1	072180136
37	4.5	242	83,50	1	072180137
38	5	248	83,50	1	072180138
39	6	255	83,50	1	072180139
40	6.5	262	83,50	1	072180140
41	7	268	83,50	1	072180141
42	8	275	83,50	1	072180142
43	9	282	83,50	1	072180143
44	10	288	83,50	1	072180144
45	10.5	295	83,50	1	072180145
46	11	302	83,50	1	072180146
47	12	308	83,50	1	072180147
48	13	315	83,50	1	072180148

- Puntale in composito
- Lamina antiperforazione in fibra composita



CE



EN ISO
20345
2011



S3 RS SRC ESD

BASIC PLUS



7201BKK

scarpe alte in pelle pieno fiore idrorepellente
NON DISPONIBILE PER LA VENDITA

- Puntale in composito
- Lamina antiperforazione in fibra composita

**EN ISO
20345
2011**

EU	UK	mm	
35	2,5	228	1 072010435
36	3,5	235	1 072010436
37	4,5	242	1 072010437
38	5	248	1 072010438
39	6	255	1 072010439
40	6,5	262	1 072010440
41	7	268	1 072010441
42	8	275	1 072010442
43	9	282	1 072010443
44	10	288	1 072010444
45	10,5	295	1 072010445
46	11	302	1 072010446
47	12	308	1 072010447
48	13	315	1 072010448



ARTICOLO NON
DISPONIBILE IN ITALIA

METAL
FREE



CE

S3 SRC

7210BKK

scarpe in morbida pelle scamosciata traforata
NON DISPONIBILE PER LA VENDITA

- Puntale in composito
- Lamina antiperforazione in fibra composita

**EN ISO
20345
2011**

EU	UK	mm	
35	2,5	228	1 072100335
36	3,5	235	1 072100336
37	4,5	242	1 072100337
38	5	248	1 072100338
39	6	255	1 072100339
40	6,5	262	1 072100340
41	7	268	1 072100341
42	8	275	1 072100342
43	9	282	1 072100343
44	10	288	1 072100344
45	10,5	295	1 072100345
46	11	302	1 072100346
47	12	308	1 072100347
48	13	315	1 072100348



ARTICOLO NON
DISPONIBILE IN ITALIA

METAL
FREE



CE

S1P SRC

7216BKK

sandali in morbida pelle scamosciata
con chiusura a strappo
NON DISPONIBILE PER LA VENDITA

- Puntale in composito
- Lamina antiperforazione in fibra composita

**EN ISO
20345
2011**

EU	UK	mm	
35	2,5	228	1 072160335
36	3,5	235	1 072160336
37	4,5	242	1 072160337
38	5	248	1 072160338
39	6	255	1 072160339
40	6,5	262	1 072160340
41	7	268	1 072160341
42	8	275	1 072160342
43	9	282	1 072160343
44	10	288	1 072160344
45	10,5	295	1 072160345
46	11	302	1 072160346
47	12	308	1 072160347
48	13	315	1 072160348



ARTICOLO NON
DISPONIBILE IN ITALIA

METAL
FREE



CE

S1P SRC

TREKKING



7236BK

scarpe alte in action nabuk idrorepellente con rapido sfilamento e copripuntale di rinforzo in poliuretano

- Punta in acciaio
- Lamina antiperforazione in fibra composita

EU	UK	mm	€		
35	2,5	228	76,00	1	072360335
36	3,5	235	76,00	1	072360336
37	4,5	242	76,00	1	072360337
38	5	248	76,00	1	072360338
39	6	255	76,00	1	072360339
40	6,5	262	76,00	1	072360340
41	7	268	76,00	1	072360341
42	8	275	76,00	1	072360342
43	9	282	76,00	1	072360343
44	10	288	76,00	1	072360344
45	10,5	295	76,00	1	072360345
46	11	302	76,00	1	072360346
47	12	308	76,00	1	072360347
48	13	315	76,00	1	072360348

CE



S3 RS SRC

**EN ISO
20345
2011**



7238WR

scarpe alte in pelle scamosciata con inserti in nylon, suola in gomma ad alta resistenza e rapido sfilamento Calzatura **WR** resistente all'acqua: sottoposta a prova, in una vasca con 3 cm di acqua, dopo 100 lunghezze, l'area totale bagnata all'interno della calzatura non deve superare i 3 cm² (macchia)

- Punta in composito
- Lamina antiperforazione in fibra composita

EU	UK	mm	€		
35	2,5	228	102,00	1	072380235
36	3,5	235	102,00	1	072380236
37	4,5	242	102,00	1	072380237
38	5	248	102,00	1	072380238
39	6	255	102,00	1	072380239
40	6,5	262	102,00	1	072380240
41	7	268	102,00	1	072380241
42	8	275	102,00	1	072380242
43	9	282	102,00	1	072380243
44	10	288	102,00	1	072380244
45	10,5	295	102,00	1	072380245
46	11	302	102,00	1	072380246
47	12	308	102,00	1	072380247
48	13	315	102,00	1	072380248

CE



S3 RS WR HRO SRC

**EN ISO
20345
2011**



7249GK

scarpe alte in pelle scamosciata con inserti in nylon, rapido sfilamento e copripuntale di rinforzo in poliuretano

- Punta in acciaio
- Lamina antiperforazione in fibra composita

EU	UK	mm	€		
35	2,5	231	64,00	1	072490235
36	3,5	238	64,00	1	072490236
37	4,5	245	64,00	1	072490237
38	5	251	64,00	1	072490238
39	6	258	64,00	1	072490239
40	6,5	265	64,00	1	072490240
41	7	271	64,00	1	072490241
42	8	278	64,00	1	072490242
43	9	285	64,00	1	072490243
44	10	291	64,00	1	072490244
45	10,5	298	64,00	1	072490245
46	11	305	64,00	1	072490246
47	12	311	64,00	1	072490247
48	13	318	64,00	1	072490248

CE



S1P RS SRC

**EN ISO
20345
2011**



ACTIVE



7314AF

scarpe in pelle scamosciata
con inserti in nylon mesh e carbon

- Puntale in composito
- Lamina antiperforazione in fibra composita

**EN ISO
20345
2011**

EU	UK	mm	€		
35	2,5	228	101,50	1	073140235
36	3,5	235	101,50	1	073140236
37	4,5	242	101,50	1	073140237
38	5	248	101,50	1	073140238
39	6	255	101,50	1	073140239
40	6,5	262	101,50	1	073140240
41	7	268	101,50	1	073140241
42	8	275	101,50	1	073140242
43	9	282	101,50	1	073140243
44	10	288	101,50	1	073140244
45	10,5	295	101,50	1	073140245
46	11	302	101,50	1	073140246
47	12	308	101,50	1	073140247
48	13	315	101,50	1	073140248



CE

S1P SRC

METAL
FREE



7315AN

scarpe in pelle scamosciata e microfibra
idrorepellenti con inserti in carbon

- Puntale in composito
- Lamina antiperforazione in fibra composita

**EN ISO
20345
2011**

EU	UK	mm	€		
35	2,5	228	117,00	1	073150535
36	3,5	235	117,00	1	073150536
37	4,5	242	117,00	1	073150537
38	5	248	117,00	1	073150538
39	6	255	117,00	1	073150539
40	6,5	262	117,00	1	073150540
41	7	268	117,00	1	073150541
42	8	275	117,00	1	073150542
43	9	282	117,00	1	073150543
44	10	288	117,00	1	073150544
45	10,5	295	117,00	1	073150545
46	11	302	117,00	1	073150546
47	12	308	117,00	1	073150547
48	13	315	117,00	1	073150548



CE

S3 SRC

METAL
FREE



7316NB

scarpe in mesh ad alta traspirazione e pelle scamosciata
con supporto di stabilità al tallone

- Puntale in composito
- Lamina antiperforazione in fibra composita

**EN ISO
20345
2011**

EU	UK	mm	€		
35	2,5	228	88,00	1	073160735
36	3,5	235	88,00	1	073160736
37	4,5	242	88,00	1	073160737
38	5	248	88,00	1	073160738
39	6	255	88,00	1	073160739
40	6,5	262	88,00	1	073160740
41	7	268	88,00	1	073160741
42	8	275	88,00	1	073160742
43	9	282	88,00	1	073160743
44	10	288	88,00	1	073160744
45	10,5	295	88,00	1	073160745
46	11	302	88,00	1	073160746
47	12	308	88,00	1	073160747
48	13	315	88,00	1	073160748



CE

S1P SRC ESD

ESD

METAL
FREE



7316NG

scarpe in mesh ad alta traspirazione e pelle scamosciata con supporto di stabilità al tallone

- Punta in composito
- Lamina antiperforazione in fibra composita

EU	UK	mm	€		
35	2.5	228	88,00	1	073160635
36	3.5	235	88,00	1	073160636
37	4.5	242	88,00	1	073160637
38	5	248	88,00	1	073160638
39	6	255	88,00	1	073160639
40	6.5	262	88,00	1	073160640
41	7	268	88,00	1	073160641
42	8	275	88,00	1	073160642
43	9	282	88,00	1	073160643
44	10	288	88,00	1	073160644
45	10.5	295	88,00	1	073160645
46	11	302	88,00	1	073160646
47	12	308	88,00	1	073160647
48	13	315	88,00	1	073160648

CE



S1P SRC ESD



7317NA

scarpe in pelle scamosciata traforata con supporto di stabilità al tallone

- Punta in composito
- Lamina antiperforazione in fibra composita

EU	UK	mm	€		
35	2.5	228	75,50	1	073170135
36	3.5	235	75,50	1	073170136
37	4.5	242	75,50	1	073170137
38	5	248	75,50	1	073170138
39	6	255	75,50	1	073170139
40	6.5	262	75,50	1	073170140
41	7	268	75,50	1	073170141
42	8	275	75,50	1	073170142
43	9	282	75,50	1	073170143
44	10	288	75,50	1	073170144
45	10.5	295	75,50	1	073170145
46	11	302	75,50	1	073170146
47	12	308	75,50	1	073170147
48	13	315	75,50	1	073170148

CE



S1P SRC



EN ISO 20345 2011

7318AN

scarpe alte in pelle scamosciata e microfibra idrorepellenti con inserti in carbon

- Punta in composito
- Lamina antiperforazione in fibra composita

EU	UK	mm	€		
35	2.5	228	121,50	1	073180535
36	3.5	235	121,50	1	073180536
37	4.5	242	121,50	1	073180537
38	5	248	121,50	1	073180538
39	6	255	121,50	1	073180539
40	6.5	262	121,50	1	073180540
41	7	268	121,50	1	073180541
42	8	275	121,50	1	073180542
43	9	282	121,50	1	073180543
44	10	288	121,50	1	073180544
45	10.5	295	121,50	1	073180545
46	11	302	121,50	1	073180546
47	12	308	121,50	1	073180547
48	13	315	121,50	1	073180548

CE



S3 SRC

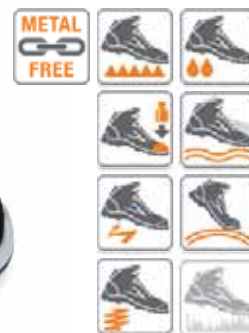

EN ISO 20345 2011

7320NA

scarpe in action nabuk idrorepellente con rinforzo antiabrasione nella zona del puntale e supporto di stabilità al tallone

- Punta in composito
- Lamina antiperforazione in fibra composita

EU	UK	mm	€		
35	2.5	228	79,50	1	073200435
36	3.5	235	79,50	1	073200436
37	4.5	242	79,50	1	073200437
38	5	248	79,50	1	073200438
39	6	255	79,50	1	073200439
40	6.5	262	79,50	1	073200440
41	7	268	79,50	1	073200441
42	8	275	79,50	1	073200442
43	9	282	79,50	1	073200443
44	10	288	79,50	1	073200444
45	10.5	295	79,50	1	073200445
46	11	302	79,50	1	073200446
47	12	308	79,50	1	073200447
48	13	315	79,50	1	073200448

CE



S3 SRC

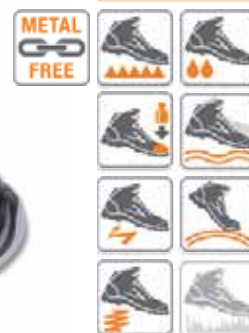

EN ISO 20345 2011

7321NA

scarpe alte in action nabuk idrorepellente
con rapido sfilamento, rinforzo antiabrasione
nella zona del puntale e supporto di stabilità al tallone

- Puntale in composito
- Lamina antiperforazione in fibra composita

EU	UK	mm	€		
35	2,5	228	82,00	1	073210435
36	3,5	235	82,00	1	073210436
37	4,5	242	82,00	1	073210437
38	5	248	82,00	1	073210438
39	6	255	82,00	1	073210439
40	6,5	262	82,00	1	073210440
41	7	268	82,00	1	073210441
42	8	275	82,00	1	073210442
43	9	282	82,00	1	073210443
44	10	288	82,00	1	073210444
45	10,5	295	82,00	1	073210445
46	11	302	82,00	1	073210446
47	12	308	82,00	1	073210447
48	13	315	82,00	1	073210448



CE

S3 RS SRC



EN ISO 20345 2011



7322SA

scarpe in tessuto altamente resistente all'abrasione
con supporto di stabilità al tallone

- Puntale in composito
- Lamina antiperforazione in fibra composita

EU	UK	mm	€		
35	2,5	228	86,00	1	073220435
36	3,5	235	86,00	1	073220436
37	4,5	242	86,00	1	073220437
38	5	248	86,00	1	073220438
39	6	255	86,00	1	073220439
40	6,5	262	86,00	1	073220440
41	7	268	86,00	1	073220441
42	8	275	86,00	1	073220442
43	9	282	86,00	1	073220443
44	10	288	86,00	1	073220444
45	10,5	295	86,00	1	073220445
46	11	302	86,00	1	073220446
47	12	308	86,00	1	073220447
48	13	315	86,00	1	073220448



CE

S3 SRC



EN ISO 20345 2011



7323SA

scarpe alte in tessuto altamente resistente all'abrasione
con rapido sfilamento e supporto di stabilità al tallone

- Puntale in composito
- Lamina antiperforazione in fibra composita

EU	UK	mm	€		
35	2,5	228	88,50	1	073230435
36	3,5	235	88,50	1	073230436
37	4,5	242	88,50	1	073230437
38	5	248	88,50	1	073230438
39	6	255	88,50	1	073230439
40	6,5	262	88,50	1	073230440
41	7	268	88,50	1	073230441
42	8	275	88,50	1	073230442
43	9	282	88,50	1	073230443
44	10	288	88,50	1	073230444
45	10,5	295	88,50	1	073230445
46	11	302	88,50	1	073230446
47	12	308	88,50	1	073230447
48	13	315	88,50	1	073230448



CE

S3 RS SRC



EN ISO 20345 2011



Beta

O-GRAVITY

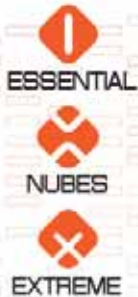

7352A

scarpe in tessuto mesh ad alta traspirazione con inserti in TPU
Supporto di stabilità tallone, collare "slip on" elasticizzato per facilitare la calzatura e suola in EVA con battistrada in gomma nitrilica ad alta resistenza

- Puntale in composito
- Lamina antiperforazione in fibra composita
- **LEGGEREZZA STRAORDINARIA:** peso indicativo misura 42: 450 grammi

EN ISO 20345 2011

EU	UK	mm	€	Art.	Art.
38	5	254	132,00	1	073520038
39	6	261	132,00	1	073520039
40	6,5	268	132,00	1	073520040
41	7	274	132,00	1	073520041
42	8	281	132,00	1	073520042
43	9	288	132,00	1	073520043
44	10	294	132,00	1	073520044
45	10,5	301	132,00	1	073520045
46	11	308	132,00	1	073520046
47	12	314	132,00	1	073520047
48	13	321	132,00	1	073520048



METAL FREE



CE

S1P HRO SRC

7352B

scarpe in tessuto mesh ad alta traspirazione con inserti in TPU
Supporto di stabilità tallone, collare "slip on" elasticizzato per facilitare la calzatura e suola in EVA con battistrada in gomma nitrilica ad alta resistenza

- Puntale in composito
- Lamina antiperforazione in fibra composita
- **LEGGEREZZA STRAORDINARIA:** peso indicativo misura 42: 450 grammi

EN ISO 20345 2011

EU	UK	mm	€	Art.	Art.
38	5	254	132,00	1	073520138
39	6	261	132,00	1	073520139
40	6,5	268	132,00	1	073520140
41	7	274	132,00	1	073520141
42	8	281	132,00	1	073520142
43	9	288	132,00	1	073520143
44	10	294	132,00	1	073520144
45	10,5	301	132,00	1	073520145
46	11	308	132,00	1	073520146
47	12	314	132,00	1	073520147
48	13	321	132,00	1	073520148



METAL FREE



CE

S1P HRO SRC

7352G

scarpe in tessuto mesh ad alta traspirazione con inserti in TPU
Supporto di stabilità tallone, **allacciatura tradizionale e calzatura ampia.**
Suola in EVA con battistrada in gomma nitrilica ad alta resistenza

- Puntale in composito
- Lamina antiperforazione in fibra composita
- **LEGGEREZZA STRAORDINARIA:** peso indicativo misura 42: 450 grammi

EN ISO 20345 2011

EU	UK	mm	€	Art.	Art.
38	5	254	136,50	1	073520338
39	6	261	136,50	1	073520339
40	6,5	268	136,50	1	073520340
41	7	274	136,50	1	073520341
42	8	281	136,50	1	073520342
43	9	288	136,50	1	073520343
44	10	294	136,50	1	073520344
45	10,5	301	136,50	1	073520345
46	11	308	136,50	1	073520346
47	12	314	136,50	1	073520347
48	13	321	136,50	1	073520348



METAL FREE



CE

S1P HRO SRC ESD

7352LG

scarpe basse da donna in tessuto mesh ad alta traspirazione con inserti in TPU

Tomaia dotata di speciali maglie riflettenti ad alta visibilità

Supporto di stabilità tallone, collare "slip on" elasticizzato per facilitare la calzata

e suola in EVA con battistrada in gomma nitrilica ad alta resistenza

- Puntale in composito
- Lamina antiperforazione in fibra composita
- **LEGGEREZZA STRAORDINARIA:** peso indicativo misura 38: **390 grammi**

EN ISO 20345 2011

EU	UK	mm	€		
34	2	228	136,00	1	073520234
35	2,5	234	136,00	1	073520235
36	3,5	241	136,00	1	073520236
37	4,5	248	136,00	1	073520237
38	5	254	136,00	1	073520238
39	6	261	136,00	1	073520239
40	6,5	268	136,00	1	073520240
41	7	274	136,00	1	073520241
42	8	281	136,00	1	073520242



lady



METAL FREE



CE

S1P HRO SRC

7353Y

scarpe in tessuto mesh ad alta traspirazione con inserti in TPU

Tomaia dotata di speciali maglie riflettenti ad alta visibilità

Supporto di stabilità tallone, collare "slip on" elasticizzato per facilitare la calzata

e suola in EVA con battistrada in gomma nitrilica ad alta resistenza

- Puntale in fibra di carbonio
- Lamina antiperforazione in fibra composita
- **LEGGEREZZA STRAORDINARIA:** peso indicativo misura 42: **420 grammi**

EN ISO 20345 2011

EU	UK	mm	€		
38	5	254	169,50	1	073530038
39	6	261	169,50	1	073530039
40	6,5	268	169,50	1	073530040
41	7	274	169,50	1	073530041
42	8	281	169,50	1	073530042
43	9	288	169,50	1	073530043
44	10	294	169,50	1	073530044
45	10,5	301	169,50	1	073530045
46	11	308	169,50	1	073530046
47	12	314	169,50	1	073530047
48	13	321	169,50	1	073530048



CE

S1P HRO SRC

7354N

scarpe in tessuto mesh idrorepellente con inserti in TPU

Supporto di stabilità tallone, collare "slip on" elasticizzato per facilitare la calzata

e suola in EVA con battistrada in gomma nitrilica ad alta resistenza

- Puntale in composito
- Lamina antiperforazione in fibra composita
- **LEGGEREZZA STRAORDINARIA:** peso indicativo misura 42: **460 grammi**

EN ISO 20345 2011

EU	UK	mm	€		
38	5	254	136,00	1	073540038
39	6	261	136,00	1	073540039
40	6,5	268	136,00	1	073540040
41	7	274	136,00	1	073540041
42	8	281	136,00	1	073540042
43	9	288	136,00	1	073540043
44	10	294	136,00	1	073540044
45	10,5	301	136,00	1	073540045
46	11	308	136,00	1	073540046
47	12	314	136,00	1	073540047
48	13	321	136,00	1	073540048



METAL FREE



CE

S3 HRO SRC

7355V

scarpe alte in tessuto mesh idrorepellente con inserti in TPU

Supporto di stabilità tallone, collare "slip on" elasticizzato per facilitare la calzata

e suola in EVA con battistrada in gomma nitrilica ad alta resistenza

- Puntale in composito
- Lamina antiperforazione in fibra composita
- **LEGGEREZZA STRAORDINARIA:** peso indicativo misura 42: **465 grammi**

EN ISO 20345 2011

EU	UK	mm	€		
38	5	254	145,50	1	073550038
39	6	261	145,50	1	073550039
40	6,5	268	145,50	1	073550040
41	7	274	145,50	1	073550041
42	8	281	145,50	1	073550042
43	9	288	145,50	1	073550043
44	10	294	145,50	1	073550044
45	10,5	301	145,50	1	073550045
46	11	308	145,50	1	073550046
47	12	314	145,50	1	073550047
48	13	321	145,50	1	073550048



METAL FREE



CE

S3 HRO SRC

7356G

scarpe in microfibra idrorepellente con inserti in TPU
Supporto di stabilità tallone, collare "slip on" elasticizzato per facilitare la calzatura e suola in EVA con battistrada in gomma nitrilica ad alta resistenza

- Puntale in composito
- Lamina antiperforazione in fibra composita
- **LEGGEREZZA STRAORDINARIA:** peso indicativo misura 42: 460 grammi

**EN ISO
20345
2011**

EU	UK	mm	€		
38	5	254	140,50	1	073560038
39	6	261	140,50	1	073560039
40	6,5	268	140,50	1	073560040
41	7	274	140,50	1	073560041
42	8	281	140,50	1	073560042
43	9	288	140,50	1	073560043
44	10	294	140,50	1	073560044
45	10,5	301	140,50	1	073560045
46	11	308	140,50	1	073560046
47	12	314	140,50	1	073560047
48	13	321	140,50	1	073560048



**METAL
FREE**



CE

S3 HRO SRC

7356V

scarpe in microfibra idrorepellente con inserti in TPU
Supporto di stabilità tallone, collare "slip on" elasticizzato per facilitare la calzatura e suola in EVA con battistrada in gomma nitrilica ad alta resistenza

- Puntale in composito
- Lamina antiperforazione in fibra composita
- **LEGGEREZZA STRAORDINARIA:** peso indicativo misura 42: 460 grammi

**EN ISO
20345
2011**

EU	UK	mm	€		
38	5	254	140,50	1	073560138
39	6	261	140,50	1	073560139
40	6,5	268	140,50	1	073560140
41	7	274	140,50	1	073560141
42	8	281	140,50	1	073560142
43	9	288	140,50	1	073560143
44	10	294	140,50	1	073560144
45	10,5	301	140,50	1	073560145
46	11	308	140,50	1	073560146
47	12	314	140,50	1	073560147
48	13	321	140,50	1	073560148



**METAL
FREE**



CE

S3 HRO SRC

7356LN

scarpe basse da donna in microfibra idrorepellente con inserti in TPU
Supporto di stabilità tallone, collare "slip on" elasticizzato per facilitare la calzatura e suola in EVA con battistrada in gomma nitrilica ad alta resistenza

- Puntale in composito
- Lamina antiperforazione in fibra composita
- **LEGGEREZZA STRAORDINARIA:** peso indicativo misura 38: 400 grammi

**EN ISO
20345
2011**

EU	UK	mm	€		
34	2	228	139,50	1	073560234
35	2,5	234	139,50	1	073560235
36	3,5	241	139,50	1	073560236
37	4,5	248	139,50	1	073560237
38	5	254	139,50	1	073560238
39	6	261	139,50	1	073560239
40	6,5	268	139,50	1	073560240
41	7	274	139,50	1	073560241
42	8	281	139,50	1	073560242



lady



**METAL
FREE**



CE

S3 HRO SRC

7357G

scarpe alte in microfibra idrorepellente con inserti in TPU
Supporto di stabilità tallone e suola in EVA con battistrada in gomma nitrilica ad alta resistenza

- Puntale in composito
- Lamina antiperforazione in fibra composita
- **LEGGEREZZA STRAORDINARIA:** peso indicativo misura 42: 480 grammi

**EN ISO
20345
2011**

EU	UK	mm	€		
38	5	254	155,50	1	073570038
39	6	261	155,50	1	073570039
40	6,5	268	155,50	1	073570040
41	7	274	155,50	1	073570041
42	8	281	155,50	1	073570042
43	9	288	155,50	1	073570043
44	10	294	155,50	1	073570044
45	10,5	301	155,50	1	073570045
46	11	308	155,50	1	073570046
47	12	314	155,50	1	073570047
48	13	321	155,50	1	073570048



**METAL
FREE**



CE

S3 HRO SRC

7357V

scarpe alte in microfibra idrorepellente con inserti in TPU
Supporto di stabilità tallone, collare elasticizzato per facilitare la calzatura e suola in EVA con battistrada in gomma nitrilica ad alta resistenza

- Puntale in composito
- Lamina antiperforazione in fibra composita
- **LEGGEREZZA STRAORDINARIA:** peso indicativo misura 42: 480 grammi

EN ISO 20345 2011

EU	UK	mm	€		
38	5	254	155,50	1	073570138
39	6	261	155,50	1	073570139
40	6,5	268	155,50	1	073570140
41	7	274	155,50	1	073570141
42	8	281	155,50	1	073570142
43	9	288	155,50	1	073570143
44	10	294	155,50	1	073570144
45	10,5	301	155,50	1	073570145
46	11	308	155,50	1	073570146
47	12	314	155,50	1	073570147
48	13	321	155,50	1	073570148

CE



S3 HRO SRC



7362B

scarpe "occupational" in tessuto mesh ad alta traspirazione con inserti in TPU
Supporto di stabilità tallone, collare "slip on" elasticizzato per facilitare la calzatura e suola in EVA con battistrada in gomma nitrilica ad alta resistenza

- Senza puntale
- Senza lamina antiperforazione
- **LEGGEREZZA STRAORDINARIA:** peso indicativo misura 42: 330 grammi

EN ISO 20347 2012

EU	UK	mm	€		
39	6	261	119,50	1	073620039
40	6,5	268	119,50	1	073620040
41	7	274	119,50	1	073620041
42	8	281	119,50	1	073620042
43	9	288	119,50	1	073620043
44	10	294	119,50	1	073620044
45	10,5	301	119,50	1	073620045
46	11	308	119,50	1	073620046
47	12	314	119,50	1	073620047
48	13	321	119,50	1	073620048

CE



01 FO HRO SRC



7363N

scarpe "occupational" in tessuto mesh idrorepellente con inserti in TPU
Supporto di stabilità tallone, collare "slip on" elasticizzato per facilitare la calzatura e suola in EVA con battistrada in gomma nitrilica ad alta resistenza

- Senza puntale
- Senza lamina antiperforazione
- **LEGGEREZZA STRAORDINARIA:** peso indicativo misura 42: 330 grammi

EN ISO 20347 2012

EU	UK	mm	€		
39	6	261	124,50	1	073630039
40	6,5	268	124,50	1	073630040
41	7	274	124,50	1	073630041
42	8	281	124,50	1	073630042
43	9	288	124,50	1	073630043
44	10	294	124,50	1	073630044
45	10,5	301	124,50	1	073630045
46	11	308	124,50	1	073630046
47	12	314	124,50	1	073630047
48	13	321	124,50	1	073630048

CE



02 FO HRO SRC



7371V

scarpe in tessuto mesh ad altissima traspirazione.
Supporto di stabilità tallone, allacciatura tradizionale e calzatura ampia. Suola in EVA con battistrada in gomma nitrilica ad alta resistenza.

- Puntale in composito
- Lamina antiperforazione in fibra composita
- **LEGGEREZZA STRAORDINARIA:** peso indicativo misura 42: 450 grammi

EN ISO 20345 2022

EU	UK	mm	€		
38	5	254	136,50	1	073710038
39	6	261	136,50	1	073710039
40	6,5	268	136,50	1	073710040
41	7	274	136,50	1	073710041
42	8	281	136,50	1	073710042
43	9	288	136,50	1	073710043
44	10	294	136,50	1	073710044
45	10,5	301	136,50	1	073710045
46	11	308	136,50	1	073710046
47	12	314	136,50	1	073710047
48	13	321	136,50	1	073710048

CE



S1PS HRO FO SR ESD



7372B

scarpe in tessuto intrecciato resistente e ad altissima traspirazione. Supporto di stabilità tallone, **allacciatura tradizionale e calzata ampia**. Suola in EVA con battistrada in gomma nitrilica ad alta resistenza.

- Puntale in composito
- Lamina antiperforazione in fibra composita
- **LEGGEREZZA STRAORDINARIA: peso indicativo misura 42: 450 grammi**

EN ISO 20345 2011

EU	UK	mm	€		
38	5	254	139,50	1	073720038
39	6	261	139,50	1	073720039
40	6,5	268	139,50	1	073720040
41	7	274	139,50	1	073720041
42	8	281	139,50	1	073720042
43	9	288	139,50	1	073720043
44	10	294	139,50	1	073720044
45	10,5	301	139,50	1	073720045
46	11	308	139,50	1	073720046
47	12	314	139,50	1	073720047
48	13	321	139,50	1	073720048



CE

S1P HRO SRC

7376A

sandalo in microfibra traforata e mesh ad alta traspirazione. Supporto di stabilità tallone, **allacciatura tradizionale con lacci elasticizzati e calzata ampia**. Suola in EVA con battistrada in gomma nitrilica ad alta resistenza.

- Puntale in composito
- Lamina antiperforazione in fibra composita
- **LEGGEREZZA STRAORDINARIA: peso indicativo misura 42: 490 grammi**

EN ISO 20345 2011

EU	UK	mm	€		
38	5	254	141,50	1	073760038
39	6	261	141,50	1	073760039
40	6,5	268	141,50	1	073760040
41	7	274	141,50	1	073760041
42	8	281	141,50	1	073760042
43	9	288	141,50	1	073760043
44	10	294	141,50	1	073760044
45	10,5	301	141,50	1	073760045
46	11	308	141,50	1	073760046
47	12	314	141,50	1	073760047
48	13	321	141,50	1	073760048



CE

S1P HRO SRC

7381N

scarpe impermeabili in tessuto altamente **resistente all'abrasione** con inserti in TPU. Supporto di stabilità tallone, allacciatura tradizionale e **calzata ampia**. Suola in EVA con battistrada in gomma nitrilica ad alta resistenza.

- Puntale in composito
- Lamina antiperforazione in fibra composita
- Membrana impermeabilizzante Beta TECH, con sistema "bootie"
- **LEGGERE: peso indicativo misura 42: 500 grammi**

EN ISO 20345 2011

EU	UK	mm	€		
38	5	254	162,00	1	073810038
39	6	261	162,00	1	073810039
40	6,5	268	162,00	1	073810040
41	7	274	162,00	1	073810041
42	8	281	162,00	1	073810042
43	9	288	162,00	1	073810043
44	10	294	162,00	1	073810044
45	10,5	301	162,00	1	073810045
46	11	308	162,00	1	073810046
47	12	314	162,00	1	073810047
48	13	321	162,00	1	073810048



CE

S3 SRC HRO WR

7382N

scarpe alte **impermeabili** in tessuto altamente **resistente all'abrasione** con inserti in TPU. Supporto di stabilità tallone, allacciatura tradizionale e **calzata ampia**. Suola in EVA con battistrada in gomma nitrilica ad alta resistenza.

- Puntale in composito
- Lamina antiperforazione in fibra composita
- Membrana impermeabilizzante Beta TECH, con sistema "bootie"
- **LEGGERE: peso indicativo misura 42: 550 grammi**

EN ISO 20345 2011

EU	UK	mm	€		
38	5	254	181,50	1	073820038
39	6	261	181,50	1	073820039
40	6,5	268	181,50	1	073820040
41	7	274	181,50	1	073820041
42	8	281	181,50	1	073820042
43	9	288	181,50	1	073820043
44	10	294	181,50	1	073820044
45	10,5	301	181,50	1	073820045
46	11	308	181,50	1	073820046
47	12	314	181,50	1	073820047
48	13	321	181,50	1	073820048



CE

S3 SRC HRO WR

HEAVY DUTY



7293HM

scarpe in pelle pieno fiore ingrassata idrorepellente con battistrada in gomma VIBRAM® ad alte prestazioni, inserto antiabrasione sul tallone e copripuntale di rinforzo in poliuretano

- Puntale in fibra di vetro
- Lamina antiperforazione in fibra composita

**EN ISO
20345
2011**

EU	UK	mm	€	SA	PC
39	6	263	181,50	1	072930639
40	6,5	270	181,50	1	072930640
41	7	276	181,50	1	072930641
42	8	283	181,50	1	072930642
43	9	289	181,50	1	072930643
44	10	296	181,50	1	072930644
45	10,5	302	181,50	1	072930645
46	11	309	181,50	1	072930646
47	12	315	181,50	1	072930647
48	13	322	181,50	1	072930648

CE



S3 HRO HI SRC



7294HM

scarpe alte in pelle pieno fiore ingrassata idrorepellente con battistrada in gomma VIBRAM® ad alte prestazioni, inserto antiabrasione sul tallone e copripuntale di rinforzo in poliuretano

- Puntale in fibra di vetro
- Lamina antiperforazione in fibra composita

**EN ISO
20345
2011**

EU	UK	mm	€	SA	PC
39	6	263	192,00	1	072940639
40	6,5	270	192,00	1	072940640
41	7	276	192,00	1	072940641
42	8	283	192,00	1	072940642
43	9	289	192,00	1	072940643
44	10	296	192,00	1	072940644
45	10,5	302	192,00	1	072940645
46	11	309	192,00	1	072940646
47	12	315	192,00	1	072940647
48	13	322	192,00	1	072940648

CE



S3 HRO HI SRC



7294HMC

scarpe alte in pelle pieno fiore ingrassata idrorepellente con battistrada in gomma VIBRAM® ad alte prestazioni, inserto antiabrasione sul tallone e copripuntale di rinforzo in poliuretano. Dotate di membrana Tepor, waterproof, antivento ed estremamente traspirante

- Puntale in fibra di vetro
- Lamina antiperforazione in fibra composita

**EN ISO
20345
2011**

EU	UK	mm	€	SA	PC
39	6	263	214,00	1	072940739
40	6,5	270	214,00	1	072940740
41	7	276	214,00	1	072940741
42	8	283	214,00	1	072940742
43	9	289	214,00	1	072940743
44	10	296	214,00	1	072940744
45	10,5	302	214,00	1	072940745
46	11	309	214,00	1	072940746
47	12	315	214,00	1	072940747
48	13	322	214,00	1	072940748

CE



S3 HRO HI CI WR SRC



ACCESSORIES

7398 0/G

sottopiedi anatomici in schiuma di EVA con cuscinetto ammortizzante nella zona del tallone (ricambio consigliato per la linea di calzature 0-Gravity)



EU	UK	€	👤	📦
38	5	7,35	1	073981238
39	6	7,35	1	073981239
40	6,5	7,35	1	073981240
41	7	7,35	1	073981241
42	8	7,35	1	073981242
43	9	7,35	1	073981243
44	10	7,35	1	073981244
45	10,5	7,35	1	073981245
46	11	7,35	1	073981246
47	12	7,35	1	073981247
48	13	7,35	1	073981248

7398ESD

sottopiede anatomico, traspirante, strato superiore antibatterico, previene dalla formazione di cattivi odori. Ricambio per calzature con certificazione ESD (ElectroStatic Discharge)



EU	UK	€	👤	📦
35	2,5	8,45	1	073981435
36	3,5	8,45	1	073981436
37	4,5	8,45	1	073981437
38	5	8,45	1	073981438
39	6	8,45	1	073981439
40	6,5	8,45	1	073981440
41	7	8,45	1	073981441
42	8	8,45	1	073981442
43	9	8,45	1	073981443
44	10	8,45	1	073981444
45	10,5	8,45	1	073981445
46	11	8,45	1	073981446
47	12	8,45	1	073981447
48	13	8,45	1	073981448

7398T

sottopiede anatomico con isolamento termico WINTHERM. 70% poliestere alluminizzato 30% polietilene, accoppiato con tessuto non tessuto in fibre sintetiche. Antistatico, traspirante, rapida assorbenza, antiodore, antibatterico, antifungo.



WINDTHERM

EU	UK	€	👤	📦
35	2,5	14,70	1	073981335
36	3,5	14,70	1	073981336
37	4,5	14,70	1	073981337
38	5	14,70	1	073981338
39	6	14,70	1	073981339
40	6,5	14,70	1	073981340
41	7	14,70	1	073981341
42	8	14,70	1	073981342
43	9	14,70	1	073981343
44	10	14,70	1	073981344
45	10,5	14,70	1	073981345
46	11	14,70	1	073981346
47	12	14,70	1	073981347
48	13	14,70	1	073981348

7398U

sottopiedi anatomici in TPR GEL con elevato effetto ammortizzante, supporto dell'arco plantare e cuscinetto nella zona del tallone



EU	UK	€	👤	📦
36 - 40	3,5 - 6,5	13,60	1	073980058
41 - 46	7 - 11	13,60	1	073980063



7398UP

sottopiedi anatomici in TPE GEL con profumo agrumato, design anatomico e supporto dell'arco plantare



EU	UK	€	👤	📦
36 - 40	3,5 - 6	12,40	1	073980076
41 - 46	7 - 11	12,40	1	073980081

7398GEL

sottopiedi anatomici con inserto in gel



EU	UK	€	👤	📦
35	2,5	4,50	1	073980835
36	3,5	4,50	1	073980836
37	4,5	4,50	1	073980837
38	5	4,50	1	073980838
39	6	4,50	1	073980839
40	6,5	4,50	1	073980840
41	7	4,50	1	073980841
42	8	4,50	1	073980842
43	9	4,50	1	073980843
44	10	4,50	1	073980844
45	10,5	4,50	1	073980845
46	11	4,50	1	073980846
47	12	4,50	1	073980847
48	13	4,50	1	073980848

7398EF

sottopiedi anatomici in schiuma di poliuretano con rialzo ammortizzante nella zona del tallone



EU	UK	€		
35	2,5	8,60	1	073981135
36	3,5	8,60	1	073981136
37	4,5	8,60	1	073981137
38	5	8,60	1	073981138
39	6	8,60	1	073981139
40	6,5	8,60	1	073981140
41	7	8,60	1	073981141
42	8	8,60	1	073981142
43	9	8,60	1	073981143
44	10	8,60	1	073981144
45	10,5	8,60	1	073981145
46	11	8,60	1	073981146
47	12	8,60	1	073981147
48	13	8,60	1	073981148

7399 A/N...

confezione 10 paia di stringhe



cm	€		
100	16,20	1	073990010
120	19,10	1	073990012
140	23,30	1	073990017

I prezzi indicati sono relativi a 10 paia

7421

calze lunghe in spugna elastocompressiva con rinforzi in nylon e cotone su punta e tallone
Pianta in fibra di bamboo, resistente, antimicotico e traspirante



	EU	€		
M	39-42	17,20	1	074210002
L	43-46	17,20	1	074210004

7422P

calze corte in spugna di cotone riciclato, con punta e tallone in spugna con effetto tremor

2 paia

varianti colore:

- nero con inserti grigi, arancione e marrone
- grigio con inserti neri, arancione e marrone



	EU	€		
M	39-42	15,00	1	074220102
L	43-46	15,00	1	074220104

7425

calze corte con inserti in texture traspirante e rinforzi in nylon/cotone su punta e tallone
Pianta in nylon intrecciato con fibra di bamboo, resistente, antimicotico e traspirante



	EU	€		
M	39-42	11,30	1	074250002
L	43-46	11,30	1	074250004

7426P

calze maxi sneaker in cotone riciclato, con pianta in spugna di cotone, punta e tallone con effetto tremor

2 paia

varianti colore:

- grigio con inserti neri e blu elettrico
- nero con inserti blu elettrico e grigi



	EU	€		
M	39-42	14,00	1	074260102
L	43-46	14,00	1	074260104

7427

calze maxi sneaker con inserti protettivi e traspiranti su zona tibia e collo del piede.
Rinforzi in nylon e cotone su punta e tallone e pianta in fibra di bamboo, resistente, antimicotico e traspirante



	EU	€		
M	39-42	9,55	1	074270002
L	43-46	9,55	1	074270004

7430T

calze sneakers in cotone riciclato, con punta e tallone in spugna con effetto tremor

3 paia

varianti colore:

- grigio melange con inserti neri e bordeaux
- nero con inserti grigi
- grigio melange con inserti neri



	EU	€		
M	39-42	18,00	1	074300202
L	43-46	18,00	1	074300204

7431P

due paia di calzini sneaker con inserti in texture traspirante e rinforzi in nylon/cotone su punta e tallone
Pianta in nylon intrecciato con fibra di bamboo, resistente, antimicotico e traspirante.
Un paio di colore nero/arancio e un paio di colore nero/grigio



	EU	€		
M	39-42	8,45	1	074310102
L	43-46	8,45	1	074310104

ABBIGLIAMENTO DA LAVORO



La linea di abbigliamento da lavoro ha conquistato nel corso degli anni la fiducia e la preferenza dei professionisti più esigenti. Il successo del prodotto ha generato la costante evoluzione e l'ampliamento della gamma di offerta.

I capi di abbigliamento prodotti da Beta Utensili S.p.a. sono conformi alla seguente normativa: **EN ISO 13688:2013**

Il DPI protegge l'utilizzatore dai rischi fisici di lieve entità come: piccole abrasioni, raggi solari, vento, freddo polveri non nocive ed imbrattamento da materiali non tossici. Tale protezione è riconducibile alla prima categoria del DDL 475 del 04/12/1992.

ISTRUZIONI PER L'UTILIZZO E LA CONSERVAZIONE

Il capo va indossato correttamente in modo che possa proteggere le parti del corpo dell'utilizzatore. Il capo va conservato in un luogo fresco ed asciutto, nel suo imballaggio originale, al riparo da fonti di calore, luce solare, polvere ed agenti atmosferici.

RESTRINGIMENTO

Tutte le fibre naturali si restringono dopo il lavaggio in acqua. Il restringimento può variare dall'1% al 5% in funzione di diversi parametri, in particolare il tipo di fibra e la temperatura dell'acqua.

CORRISPONDENZA TAGLIE

		UOMO						DONNA							
		I	F	D	E	UK	USA			I	F	D	E	UK	USA
UOMO	XS	46	38	42	40	30	32	DONNA	XS	38	34	32	34	6	2
	S	48	40	44	42	32	34		S	40	36	34	36	8	4
	M	50	42	46	44	34	36		M	42	38	36	38	10	6
	L	52	44	48	46	36	38		L	44	40	38	40	12	8
	XL	54	46	50	48	38	40		XL	46	42	40	42	14	10
	2XL	56	48	52	50	40	42		2XL	48	44	42	44	16	12
3XL	58	50	54	52	42	44	3XL	50	46	44	46	18	14		
4XL	60	52	56	54	44	46									
5XL	62	54	58	56	46	48									

MISURE ANATOMICHE EN ISO 13688:2013

UOMO		A		B		H				
		XS	S	M	L	XL	2XL	3XL	4XL	5XL
A	88-92	92-96	96-104	104-108	108-116	116-124	124-132	132-140	140-148	
B	79-83	83-87	87-91	91-95	95-100	100-107	107-112	112-120	120-128	
H	158-164	164-170	170-176	176-182	182-188	188-194	194-200	200-206	206-212	

DONNA		A		B		H		
		XS	S	M	L	XL	2XL	3XL
A	72-77	77-82	82-87	87-93	93-99	99-105	105-111	
B	162-165	164-167	168-171	170-173	172-175	174-177	176-179	

GUIDA ALLA SCELTA ABBIGLIAMENTO LISTINO 2024

Categoria	Codice Articolo	Linea	Pag	Colore	Abbinamenti suggeriti (tessuto e colore uguali al pantalone)									
					Bermuda	Pag	Salopette	Pag	Tuta	Pag	Gilet	Pag	Giacca	Pag
PANTALONI DA LAVORO LEGGERI	7610G	Trekking	653	■	7611G	657								
	7610N		653	■										
	7660B	Top Line	653	■	7661B	657								
	7660G		653	■	7661G	657								
	7830SN	Stretch	654	■	7831SN	657								
	7860G	Beta Easy	655	■	7861G	658	7863G	658	7865G	659	7867G	661	7869G	660
	7860B		655	■	7861B	658			7865B	659	7867B	661		
	7930MG	Cotton	656	■	7931MG	658			7935MG	659	7937MG	662		
PANTALONI DA LAVORO 4 STAGIONI	7600G	Trekking	652	■										
	7600N		652	■										
	7650	Top Line	653	■								7653G	660	
	7650B		653	■										
	7818BL		654	■										
	7818CM		654	■	7815CM	657								
	7818G		654	■										
	7819G		654	■										
	7830ST	Stretch	655	■	7831ST	657								
	7840BL	Beta Easy	655	■								7849BL	660	
	7850G		655	■										
	7880SC	Stretch	655	■										
	7900B	Beta Easy	656	■								7909B	660	
	7900G		656	■	7901G	658	7903G	659	7905G	659	7907G	662	7909G	660
	7900P		656	■			7903P	659					7909P	660
7900V	656		■									7909V	660	
7940	Multiprotezione	656	■								7949	661		
7818LN	Lady	654	■											

GUIDA ALLA SCELTA ABBIGLIAMENTO LISTINO 2024

Categoria	Codice Articolo	Linea	Pag	Colore	Abbinamenti suggeriti (tessuto e colore uguali al pantalone)									
					Bermuda	Pag	Salopette	Pag	Tuta	Pag	Gilet	Pag	Giacca	Pag
JEANS DA LAVORO	7530		652											
	7528		652		7529	657								
	7527		652											
POLO	7547AZ		664		ABBINABILI A TUTTI GLI ALTRI CAPI IN FUNZIONE DEGLI ACCOSTAMENTI CROMATICI									
	7547BL		665											
	7547G		665											
	7547N		665											
	7547R		665											
7557BL		666												
T-SHIRT	7548M		665		ABBINABILI A TUTTI GLI ALTRI CAPI IN FUNZIONE DEGLI ACCOSTAMENTI CROMATICI									
	7548C		665											
	7549AZ		665											
	7549BL		665											
	7549G		665											
	7549N		666											
	7549NE		666											
	7549R		666											
	7550G	Top Line	666											
7550N	Top Line	666												
CAMICIE	7545F		664											
FELPE	7637G		663		ABBINABILI A TUTTI GLI ALTRI CAPI IN FUNZIONE DEGLI ACCOSTAMENTI CROMATICI									
	7642G		663											
	7664G	Top Line	664											
	7664N		664											
	7665G		664											
7665N	664													
PILE E MICROPILE	7636N		663											
	7654B	Top Line	663											
	7654N		664											
	7657B		664											
7657N	667													
GILET	7575N		661		ABBINABILI A TUTTI GLI ALTRI CAPI IN FUNZIONE DEGLI ACCOSTAMENTI CROMATICI									
	7579QN		661											
	7673NG	Top Line	661											
GIACCHE E SOFTSHELL	7658CM	Top Line	662		ABBINABILI A TUTTI GLI ALTRI CAPI IN FUNZIONE DEGLI ACCOSTAMENTI CROMATICI									
	7659N		662											
	7669N		662											
GIUBBOTTI IMBOTTITI	7670G	Top Line	662		ABBINABILI A TUTTI GLI ALTRI CAPI IN FUNZIONE DEGLI ACCOSTAMENTI CROMATICI									
	7674NG		663											
	7780QN		663											
	7750N		663											

GUIDA ALLA SCELTA ABBIGLIAMENTO LISTINO 2024

Categoria	Codice Articolo	Tipologia di capo	Pag	Colore	Abbinamenti suggeriti (tessuto e colore uguali al pantalone)									
					Bermuda	Pag	Salopette	Pag	Tuta	Pag	Gilet	Pag	Giacca	Pag
ABBIGLIAMENTO ANTIPIOGGIA	7970	Pantalone	666										7979	667
	7971L	Pantalone	667										7978L	667
	7981N	Cappellino anti pioggia	668											
ACCESSORI	7980NC	Berretto	668											
	7980RN	Berretto	668											
	7980L	Berretto con luce	668											
	7982N	Cappellino	668											
	7984EG	Cintura	668											
	7984G	Cintura	668											
	7985N	Scaldacollo	668											
7996N	Set intimo tecnico	667												

PANTS



7527
jeans da lavoro
in 70% cotone, 27% poliestere e 3% tessuto
elastico
Regular fit

CE
Jeans



taglia	l	€	1	075270046
XS	46	55,00	1	075270046
S	48	55,00	1	075270048
M	50	55,00	1	075270050
L	52	55,00	1	075270052
XL	54	55,00	1	075270054
XXL	56	55,00	1	075270056
XXXL	58	55,00	1	075270058

7528
jeans da lavoro elasticizzati
in 98% cotone e 2% tessuto elasticizzato
Slim fit

CE
Jeans



taglia	l	€	1	075280046
XS	46	60,50	1	075280046
S	48	60,50	1	075280048
M	50	60,50	1	075280050
L	52	60,50	1	075280052
XL	54	60,50	1	075280054
XXL	56	60,50	1	075280056
XXXL	58	60,50	1	075280058

7530
jeans da lavoro elasticizzati
in 98% cotone e 2% tessuto elasticizzato, con
rinforzi in poliestere
Slim fit

CE
Jeans



taglia	l	€	1	075300046
XS	46	71,00	1	075300046
S	48	71,00	1	075300048
M	50	71,00	1	075300050
L	52	71,00	1	075300052
XL	54	71,00	1	075300054
XXL	56	71,00	1	075300056
XXXL	58	71,00	1	075300058

7600G
pantaloni "work trekking" HEAVY
90% nylon, 10% tessuto elasticizzato, 265 g,
tessuto rinforzato su ginocchia e retro, fondo
gamba elasticizzato con chiusura zip verticale
Grigio scuro con dettagli verde fluo
Slim fit

CE
**TREKKING
HEAVY**



taglia	l	€	1	076000000
XS	46	74,00	1	076000000
S	48	74,00	1	076000001
M	50	74,00	1	076000002
L	52	74,00	1	076000003
XL	54	74,00	1	076000004
XXL	56	74,00	1	076000005
XXXL	58	74,00	1	076000006

7600N
pantaloni "work trekking" HEAVY
90% nylon, 10% tessuto elasticizzato, 265 g,
tessuto rinforzato su ginocchia e retro, fondo
gamba elasticizzato con chiusura zip verticale
Nero con dettagli verde fluo
Slim fit

CE
**TREKKING
HEAVY**



taglia	l	€	1	076000100
XS	46	74,00	1	076000100
S	48	74,00	1	076000101
M	50	74,00	1	076000102
L	52	74,00	1	076000103
XL	54	74,00	1	076000104
XXL	56	74,00	1	076000105
XXXL	58	74,00	1	076000106

7610G

pantaloni "work trekking" LIGHT
90% nylon, 10% tessuto elasticizzato, 140 g,
tessuto rinforzato su ginocchia e retro, fondo
gamba elasticizzato e regolabile con coulisse
Grigio scuro con dettagli in giallo
Slim fit

CE

TREKKING
LIGHT

Taglie	I	€	Articolo
XS	46	72,00	1 076100000
S	48	72,00	1 076100001
M	50	72,00	1 076100002
L	52	72,00	1 076100003
XL	54	72,00	1 076100004
XXL	56	72,00	1 076100005
XXXL	58	72,00	1 076100006

7610N

pantaloni "work trekking" LIGHT
90% nylon, 10% tessuto elasticizzato, 140 g,
tessuto rinforzato su ginocchia e retro, fondo
gamba elasticizzato e regolabile con coulisse
Nero con dettagli in giallo
Slim fit

CE

TREKKING
LIGHT

Taglie	I	€	Articolo
XS	46	72,00	1 076100100
S	48	72,00	1 076100101
M	50	72,00	1 076100102
L	52	72,00	1 076100103
XL	54	72,00	1 076100104
XXL	56	72,00	1 076100105
XXXL	58	72,00	1 076100106

7650

pantaloni da lavoro multitasche elasticizzati
90% Nylon -10% spandex, **260 g, antracite**
Tasche per ginocchiere, tasche posteriori e
fondo gamba rinforzati in poliesteri 600D,
cavallo antistrappo
Slim fit

CE

TOP
line

Taglie	I	€	Articolo
XS	46	93,50	1 076500000
S	48	93,50	1 076500001
M	50	93,50	1 076500002
L	52	93,50	1 076500003
XL	54	93,50	1 076500004
XXL	56	93,50	1 076500005
XXXL	58	93,50	1 076500006

7650B

pantaloni da lavoro multitasche elasticizzati
90% Nylon -10% spandex, **260 g, blu**
Tasche per ginocchiere, tasche posteriori e
fondo gamba rinforzati in poliesteri 600D,
cavallo antistrappo
Slim fit

CE

TOP
line

Taglie	I	€	Articolo
XS	46	93,50	1 076500100
S	48	93,50	1 076500101
M	50	93,50	1 076500102
L	52	93,50	1 076500103
XL	54	93,50	1 076500104
XXL	56	93,50	1 076500105
XXXL	58	93,50	1 076500106

7660B

pantaloni da lavoro leggeri, multitasche
elasticizzati
86% Nylon - 14% spandex, **140 g, blu**
Tasche per ginocchiere, tasche posteriori
rinforzate in poliesteri 300D, cavallo
antistrappo
Slim fit

CE

TOP
line

Taglie	I	€	Articolo
XS	46	80,50	1 076600100
S	48	80,50	1 076600101
M	50	80,50	1 076600102
L	52	80,50	1 076600103
XL	54	80,50	1 076600104
XXL	56	80,50	1 076600105
XXXL	58	80,50	1 076600106

7660G

pantaloni da lavoro leggeri, multitasche
elasticizzati
86% Nylon - 14% spandex, **140 g, antracite**
Tasche per ginocchiere, tasche posteriori
rinforzate in poliesteri 300D, cavallo
antistrappo
Slim fit

CE

TOP
line

Taglie	I	€	Articolo
XS	46	80,50	1 076600000
S	48	80,50	1 076600001
M	50	80,50	1 076600002
L	52	80,50	1 076600003
XL	54	80,50	1 076600004
XXL	56	80,50	1 076600005
XXXL	58	80,50	1 076600006

7818G

pantaloni da lavoro multitasche in T/C Canvas 260 g, grigio

Tasche per ginocchiere e fondo gamba rinforzati in poliestere 300D, cavallo antistrappo ed inserto in tessuto elasticizzato nell'interno gamba e nella zona lombare per facilitare i movimenti

CE



Dimensione	I	€	Art.
XS	46	72,00	1 078180000
S	48	72,00	1 078180001
M	50	72,00	1 078180002
L	52	72,00	1 078180003
XL	54	72,00	1 078180004
XXL	56	72,00	1 078180005
XXXL	58	72,00	1 078180006

7818BL

pantaloni da lavoro multitasche in T/C Canvas 260 g, blu

Tasche per ginocchiere e fondo gamba rinforzati in poliestere 300D, cavallo antistrappo ed inserto in tessuto elasticizzato nell'interno gamba e nella zona lombare per facilitare i movimenti

CE



Dimensione	I	€	Art.
XS	46	72,00	1 078180100
S	48	72,00	1 078180101
M	50	72,00	1 078180102
L	52	72,00	1 078180103
XL	54	72,00	1 078180104
XXL	56	72,00	1 078180105
XXXL	58	72,00	1 078180106

7818CM

pantaloni da lavoro multitasche in T/C Canvas 260 g, camouflage grigio

Tasche per ginocchiere e fondo gamba rinforzati in poliestere 300D, cavallo antistrappo ed inserto in tessuto elasticizzato nell'interno gamba e nella zona lombare per facilitare i movimenti

CE



Dimensione	I	€	Art.
XS	46	76,00	1 078180300
S	48	76,00	1 078180301
M	50	76,00	1 078180302
L	52	76,00	1 078180303
XL	54	76,00	1 078180304
XXL	56	76,00	1 078180305
XXXL	58	76,00	1 078180306

7818LN

pantaloni da lavoro **da donna** multitasche, neri con dettagli rosa

100% cotone elasticizzato, 220 g

Tasche per ginocchiere e fondo gamba rinforzati in poliestere 300D, cavallo antistrappo ed inserto in tessuto elasticizzato nell'interno gamba per facilitare i movimenti

CE

lady



Dimensione	I	€	Art.
XS	38	72,00	1 078180200
S	40	72,00	1 078180201
M	42	72,00	1 078180202
L	44	72,00	1 078180203
XL	46	72,00	1 078180204
XXL	48	72,00	1 078180205
XXXL	50	72,00	1 078180206

7819G

pantaloni da lavoro multitasche con tasche removibili flying pockets, in T/C Canvas 260 g, grigio

Tasche per ginocchiere e fondo gamba rinforzati in poliestere 300D, cavallo antistrappo ed inserto in tessuto elasticizzato nell'interno gamba e nella zona lombare per facilitare i movimenti

CE



Dimensione	I	€	Art.
XS	46	72,00	1 078190000
S	48	72,00	1 078190001
M	50	72,00	1 078190002
L	52	72,00	1 078190003
XL	54	72,00	1 078190004
XXL	56	72,00	1 078190005
XXXL	58	72,00	1 078190006

7830SN

pantaloni da lavoro elasticizzati in T/C Twill 200 g, nero

Slim fit, cavallo antistrappo e vita elasticizzata ai lati

CE

STRETCH



Dimensione	I	€	Art.
XS	46	64,00	1 078300100
S	48	64,00	1 078300101
M	50	64,00	1 078300102
L	52	64,00	1 078300103
XL	54	64,00	1 078300104
XXL	56	64,00	1 078300105
XXXL	58	64,00	1 078300106

7830ST

pantaloni da lavoro elasticizzati
in T/C Twill 250 g, grigio
Slim fit, cavallo antistrappo e vita elasticizzata
ai lati

CE



	I	€		
XS	46	64,00	1	078300000
S	48	64,00	1	078300001
M	50	64,00	1	078300002
L	52	64,00	1	078300003
XL	54	64,00	1	078300004
XXL	56	64,00	1	078300005
XXXL	58	64,00	1	078300006

7840BL

pantaloni da lavoro in T/C twill 245 g, blu
Vita elasticizzata ai lati

CE

BetaEASY



	I	€		
XS	46	41,00	1	078400100
S	48	41,00	1	078400101
M	50	41,00	1	078400102
L	52	41,00	1	078400103
XL	54	41,00	1	078400104
XXL	56	41,00	1	078400105
XXXL	58	41,00	1	078400106
XXXXL	60	41,00	1	078400107

7850G

pantaloni da lavoro cargo,
in 100% cotone, 240 g/m²,
vita elasticizzata ai lati e tasconi laterali con
inserti reflex,
grigio con dettagli verdi fluo
Slim fit

CE



	I	€		
XS	46	46,50	1	078500100
S	48	46,50	1	078500101
M	50	46,50	1	078500102
L	52	46,50	1	078500103
XL	54	46,50	1	078500104
XXL	56	46,50	1	078500105
XXXL	58	46,50	1	078500106
XXXXL	60	46,50	1	078500107

7860B

pantaloni leggeri da lavoro
in T/C twill 180 g con inserti in Oxford, blu

CE



	I	€		
XS	46	53,00	1	078600700
S	48	53,00	1	078600701
M	50	53,00	1	078600702
L	52	53,00	1	078600703
XL	54	53,00	1	078600704
XXL	56	53,00	1	078600705
XXXL	58	53,00	1	078600706
XXXXL	60	53,00	1	078600707
5XL	62	53,00	1	078600708

7860G

pantaloni leggeri da lavoro
in T/C twill 180 g con inserti in Oxford, grigio

CE

BetaEASY

LIGHT



	I	€		
XS	46	53,00	1	078600800
S	48	53,00	1	078600801
M	50	53,00	1	078600802
L	52	53,00	1	078600803
XL	54	53,00	1	078600804
XXL	56	53,00	1	078600805
XXXL	58	53,00	1	078600806
XXXXL	60	53,00	1	078600807
5XL	62	53,00	1	078600808

7880SC

pantaloni da lavoro elasticizzati
in T/C Canvas 290 g, nero
Slim fit, cavallo antistrappo e vita elasticizzata
ai lati

CE



	I	€		
XS	46	65,00	1	078800000
S	48	65,00	1	078800001
M	50	65,00	1	078800002
L	52	65,00	1	078800003
XL	54	65,00	1	078800004
XXL	56	65,00	1	078800005
XXXL	58	65,00	1	078800006

7900B
pantaloni da lavoro
in T/C canvas 260 g con inserti in Oxford, blu

CE

Beta EASY



Taglia	l	€	Articolo
XS	46	58,50	1 079000700
S	48	58,50	1 079000701
M	50	58,50	1 079000702
L	52	58,50	1 079000703
XL	54	58,50	1 079000704
XXL	56	58,50	1 079000705
XXXL	58	58,50	1 079000706
XXXXL	60	58,50	1 079000707

7900G
pantaloni da lavoro
in T/C canvas 260 g con inserti in Oxford, grigio

CE

Beta EASY



Taglia	l	€	Articolo
XS	46	58,50	1 079000800
S	48	58,50	1 079000801
M	50	58,50	1 079000802
L	52	58,50	1 079000803
XL	54	58,50	1 079000804
XXL	56	58,50	1 079000805
XXXL	58	58,50	1 079000806
XXXXL	60	58,50	1 079000807

7900P
pantaloni da lavoro
in T/C canvas 260 g con inserti in Oxford, petrol

CE

Beta EASY



Taglia	l	€	Articolo
XS	46	58,50	1 079000600
S	48	58,50	1 079000601
M	50	58,50	1 079000602
L	52	58,50	1 079000603
XL	54	58,50	1 079000604
XXL	56	58,50	1 079000605
XXXL	58	58,50	1 079000606
XXXXL	60	58,50	1 079000607

7900V
pantaloni da lavoro
in T/C canvas 260 g con inserti in Oxford, verde

CE

Beta EASY



Taglia	l	€	Articolo
XS	46	58,50	1 079000500
S	48	58,50	1 079000501
M	50	58,50	1 079000502
L	52	58,50	1 079000503
XL	54	58,50	1 079000504
XXL	56	58,50	1 079000505
XXXL	58	58,50	1 079000506
XXXXL	60	58,50	1 079000507

7930MG
pantaloni da lavoro multitasche in 97% cotone
3% tessuto elasticizzato, 220 g/m², grigio

CE

Cotton



Taglia	l	€	Articolo
XS	46	59,50	1 079300400
S	48	59,50	1 079300401
M	50	59,50	1 079300402
L	52	59,50	1 079300403
XL	54	59,50	1 079300404
XXL	56	59,50	1 079300405
XXXL	58	59,50	1 079300406

7940
pantalone da lavoro multiprotezione
in T/C Twill 250 g, blu
protezione da calore, fiamme, arco elettrico,
rischi derivanti da saldatura e protezione da
agenti chimici.

CE



DPI: III^a Categoria
EN ISO 11611:2015 - Classe 1
EN ISO 11612:2015 - A1 B1 C1
EN 1149-5:2018
EN13034:2005+A1:2009 - Type 6
IEC 61482-2:2018 - APC 1

Taglia	l	€	Articolo
XS	46	85,50	1 079400000
S	48	85,50	1 079400001
M	50	85,50	1 079400002
L	52	85,50	1 079400003
XL	54	85,50	1 079400004
XXL	56	85,50	1 079400005
XXXL	58	85,50	1 079400006
XXXXL	60	85,50	1 079400007

BERMUDA



7529

bermuda jeans da lavoro elasticizzati
in 98% cotone e 2% tessuto elasticizzato
Slim fit

CE

Jeans



	I	€		
XS	46	48,00	1	075290046
S	48	48,00	1	075290048
M	50	48,00	1	075290050
L	52	48,00	1	075290052
XL	54	48,00	1	075290054
XXL	56	48,00	1	075290056
XXXL	58	48,00	1	075290058

7611G

bermuda "work trekking" LIGHT
90% nylon, 10% tessuto elasticizzato, 140 g,
tessuto rinforzato su retro.
Grigio scuro con dettagli in giallo
Slim fit

CE

TREKING
LIGHT



	I	€		
XS	46	55,00	1	076110000
S	48	55,00	1	076110001
M	50	55,00	1	076110002
L	52	55,00	1	076110003
XL	54	55,00	1	076110004
XXL	56	55,00	1	076110005
XXXL	58	55,00	1	076110006

7661B

bermuda leggeri da lavoro, multitasche
elasticizzati
86% Nylon - 14% spandex, 140 g, blu
Tasche posteriori rinforzate in poliestere 300D,
cavallo antistrappo
Slim fit

CE



TOP
line



	I	€		
XS	46	70,00	1	076610100
S	48	70,00	1	076610101
M	50	70,00	1	076610102
L	52	70,00	1	076610103
XL	54	70,00	1	076610104
XXL	56	70,00	1	076610105
XXXL	58	70,00	1	076610106

7661G

bermuda leggeri da lavoro, multitasche
elasticizzati
86% Nylon - 14% spandex, 140 g, antracite
Tasche posteriori rinforzate in poliestere 300D,
cavallo antistrappo
Slim fit

CE



TOP
line



	I	€		
XS	46	70,00	1	076610000
S	48	70,00	1	076610001
M	50	70,00	1	076610002
L	52	70,00	1	076610003
XL	54	70,00	1	076610004
XXL	56	70,00	1	076610005
XXXL	58	70,00	1	076610006



7815CM

bermuda da lavoro multitasche in T/C Canvas
260 g, camouflage grigio, cavallo antistrappo
ed inserto in tessuto elasticizzato nell'interno
gamba e nella zona lombare per facilitare i
movimenti

CE



	I	€		
XS	46	59,50	1	078150300
S	48	59,50	1	078150301
M	50	59,50	1	078150302
L	52	59,50	1	078150303
XL	54	59,50	1	078150304
XXL	56	59,50	1	078150305
XXXL	58	59,50	1	078150306

7831SN

bermuda da lavoro elasticizzati
in T/C Twill 200 g, nero
Slim fit, cavallo antistrappo e vita elasticizzata
ai lati

CE



	I	€		
XS	46	48,50	1	078310100
S	48	48,50	1	078310101
M	50	48,50	1	078310102
L	52	48,50	1	078310103
XL	54	48,50	1	078310104
XXL	56	48,50	1	078310105
XXXL	58	48,50	1	078310106

7831ST

bermuda da lavoro elasticizzati
in T/C Twill 250 g, grigio
Slim fit, cavallo antistrappo e vita elasticizzata
ai lati

CE



	I	€		
XS	46	48,50	1	078310000
S	48	48,50	1	078310001
M	50	48,50	1	078310002
L	52	48,50	1	078310003
XL	54	48,50	1	078310004
XXL	56	48,50	1	078310005
XXXL	58	48,50	1	078310006

7861G

bermuda leggeri da lavoro
in T/C twill 180 g con inserti in Oxford, grigio



Dimensione	I	€	Articolo
XS	46	44,00	1 078610800
S	48	44,00	1 078610801
M	50	44,00	1 078610802
L	52	44,00	1 078610803
XL	54	44,00	1 078610804
XXL	56	44,00	1 078610805
XXXL	58	44,00	1 078610806
XXXXL	60	44,00	1 078610807
5XL	62	44,00	1 078610808

7861B

bermuda leggeri da lavoro
in T/C twill 180 g con inserti in Oxford, blu



Dimensione	I	€	Articolo
XS	46	44,00	1 078610700
S	48	44,00	1 078610701
M	50	44,00	1 078610702
L	52	44,00	1 078610703
XL	54	44,00	1 078610704
XXL	56	44,00	1 078610705
XXXL	58	44,00	1 078610706
XXXXL	60	44,00	1 078610707
5XL	62	44,00	1 078610708

7901G

bermuda da lavoro
in T/C canvas 260 g con inserti in Oxford, grigio



Dimensione	I	€	Articolo
XS	46	47,50	1 079010800
S	48	47,50	1 079010801
M	50	47,50	1 079010802
L	52	47,50	1 079010803
XL	54	47,50	1 079010804
XXL	56	47,50	1 079010805
XXXL	58	47,50	1 079010806
XXXXL	60	47,50	1 079010807

7931MG

bermuda da lavoro in 97% cotone 3% tessuto
elasticozzato, 220 g/m², grigio



Dimensione	I	€	Articolo
XS	46	48,00	1 079310400
S	48	48,00	1 079310401
M	50	48,00	1 079310402
L	52	48,00	1 079310403
XL	54	48,00	1 079310404
XXL	56	48,00	1 079310405
XXXL	58	48,00	1 079310406



OVERALLS



7863G

Salopette leggera da lavoro
in T/C twill 180 g con inserti in Oxford, grigio



Dimensione	I	€	Articolo
XS		65,00	1 078630800
S		65,00	1 078630801
M		65,00	1 078630802
L		65,00	1 078630803
XL		65,00	1 078630804
XXL		65,00	1 078630805
XXXL		65,00	1 078630806
XXXXL		65,00	1 078630807
5XL		65,00	1 078630808

7903G

Salopette da lavoro
in T/C canvas 260 g con inserti in Oxford,
grigio

CE

BetaEASY



	€		
XS	73,50	1	079030800
S	73,50	1	079030801
M	73,50	1	079030802
L	73,50	1	079030803
XL	73,50	1	079030804
XXL	73,50	1	079030805
XXXL	73,50	1	079030806
XXXXL	73,50	1	079030807

7903P

Salopette da lavoro
in T/C canvas 260 g con inserti in Oxford,
petrol

CE

BetaEASY



	€		
XS	73,50	1	079030600
S	73,50	1	079030601
M	73,50	1	079030602
L	73,50	1	079030603
XL	73,50	1	079030604
XXL	73,50	1	079030605
XXXL	73,50	1	079030606
XXXXL	73,50	1	079030607

7865B

tuta leggera da lavoro
in T/C twill 180 g con inserti in Oxford, blu

CE

BetaEASY

LIGHT



	€		
XS	84,50	1	078650700
S	84,50	1	078650701
M	84,50	1	078650702
L	84,50	1	078650703
XL	84,50	1	078650704
XXL	84,50	1	078650705
XXXL	84,50	1	078650706
XXXXL	84,50	1	078650707
5XL	84,50	1	078650708

7865G

Tuta leggera da lavoro
in T/C twill 180 g con inserti in Oxford, grigio

CE

BetaEASY

LIGHT



	€		
XS	84,50	1	078650800
S	84,50	1	078650801
M	84,50	1	078650802
L	84,50	1	078650803
XL	84,50	1	078650804
XXL	84,50	1	078650805
XXXL	84,50	1	078650806
XXXXL	84,50	1	078650807
5XL	84,50	1	078650808

7905G

Tuta da lavoro
in T/C canvas 260 g con inserti in Oxford,
grigio

CE

BetaEASY



	€		
XS	91,50	1	079050800
S	91,50	1	079050801
M	91,50	1	079050802
L	91,50	1	079050803
XL	91,50	1	079050804
XXL	91,50	1	079050805
XXXL	91,50	1	079050806
XXXXL	91,50	1	079050807

7935MG

tuta da lavoro in 97% cotone 3% tessuto
elasticizzato, 220 g/m², grigio

CE

Cotton



	€		
XS	104,50	1	079350400
S	104,50	1	079350401
M	104,50	1	079350402
L	104,50	1	079350403
XL	104,50	1	079350404
XXL	104,50	1	079350405
XXXL	104,50	1	079350406

WORK JACKETS



7653G

giacca da lavoro multitasche elasticizzate
90% Nylon -10% spandex, 260g/m², grigio
antracite

CE



TOP
line



taglia	€	1	076530000
XS	94,00	1	076530000
S	94,00	1	076530001
M	94,00	1	076530002
L	94,00	1	076530003
XL	94,00	1	076530004
XXL	94,00	1	076530005
XXXL	94,00	1	076530006

7849BL

giacca da lavoro in T/C twill 245 g, blu
Fascia in vita elasticizzata

CE

Beta EASY



taglia	€	1	078490100
XS	44,00	1	078490100
S	44,00	1	078490101
M	44,00	1	078490102
L	44,00	1	078490103
XL	44,00	1	078490104
XXL	44,00	1	078490105
XXXL	44,00	1	078490106
XXXXL	44,00	1	078490107

7869G

giacca leggera da lavoro
in T/C twill 180 g con inserti in Oxford, grigio

CE

Beta EASY

LIGHT



taglia	€	1	078690800
XS	57,50	1	078690800
S	57,50	1	078690801
M	57,50	1	078690802
L	57,50	1	078690803
XL	57,50	1	078690804
XXL	57,50	1	078690805
XXXL	57,50	1	078690806
XXXXL	57,50	1	078690807
5XL	57,50	1	078690808

7909B

giacca da lavoro
in T/C canvas 260 g con inserti in Oxford, blu

CE

Beta EASY



taglia	€	1	079090700
XS	65,00	1	079090700
S	65,00	1	079090701
M	65,00	1	079090702
L	65,00	1	079090703
XL	65,00	1	079090704
XXL	65,00	1	079090705
XXXL	65,00	1	079090706
XXXXL	65,00	1	079090707

7909G

giacca da lavoro
in T/C canvas 260 g con inserti in Oxford,
grigio

CE

Beta EASY



taglia	€	1	079090800
XS	65,00	1	079090800
S	65,00	1	079090801
M	65,00	1	079090802
L	65,00	1	079090803
XL	65,00	1	079090804
XXL	65,00	1	079090805
XXXL	65,00	1	079090806
XXXXL	65,00	1	079090807

7909P

giacca da lavoro
in T/C canvas 260 g con inserti in Oxford,
petrol

CE

Beta EASY



taglia	€	1	079090600
XS	65,00	1	079090600
S	65,00	1	079090601
M	65,00	1	079090602
L	65,00	1	079090603
XL	65,00	1	079090604
XXL	65,00	1	079090605
XXXL	65,00	1	079090606
XXXXL	65,00	1	079090607

7909V

giacca da lavoro
in T/C canvas 260 g con inserti in Oxford,
verde

CE

Beta EASY



taglia	€	1	079090500
XS	65,00	1	079090500
S	65,00	1	079090501
M	65,00	1	079090502
L	65,00	1	079090503
XL	65,00	1	079090504
XXL	65,00	1	079090505
XXXL	65,00	1	079090506
XXXXL	65,00	1	079090507



7949

giacca da lavoro multiprotezione
in T/C Twill 250 g, blu
protezione da calore, fiamme, arco elettrico,
rischi derivanti da saldatura e protezione da
agenti chimici.

CE

DPI: III^a Categoria
EN ISO 11611:2015 - Classe 1
EN ISO 11612:2015 - A1 B1 C1
EN 1149-5:2018
EN13034:2005+A1:2009 - Type 6
IEC 61482-2:2018 - APC 1



	€		
XS	98,50	1	079490000
S	98,50	1	079490001
M	98,50	1	079490002
L	98,50	1	079490003
XL	98,50	1	079490004
XXL	98,50	1	079490005
XXXL	98,50	1	079490006
XXXXL	98,50	1	079490007

SLEEVELESS JACKETS



7575N

gilet softshell
in 90% nylon, 10% tessuto elasticizzato, 250 g



	€		
S	86,50	1	075750301
M	86,50	1	075750302
L	86,50	1	075750303
XL	86,50	1	075750304
XXL	86,50	1	075750305
XXXL	86,50	1	075750306

7579QN

gilet da lavoro multitasca in doppio materiale.
100% nylon impermeabilizzato 300D e tessuto
softshell 96% poliestere, 4% spandex,
imbottitura in poliestere 160 g
nero/grigio antracite

CE



	€		
S	74,50	1	075790201
M	74,50	1	075790202
L	74,50	1	075790203
XL	74,50	1	075790204
XXL	74,50	1	075790205
XXXL	74,50	1	075790206

7673NG

gilet da lavoro con imbottitura in GRAPHENE
80 g,
parte frontale rinforzata in tessuto softshell
96% poliestere, 4% spandex, parte retro in
100% nylon 20D
grigio antracite (fronte), nero (retro)
Insero elastico sul giromanica
Antistatico, antibatterico, antivento,
termoregolatore

CE



	€		
S	95,00	1	076730001
M	95,00	1	076730002
L	95,00	1	076730003
XL	95,00	1	076730004
XXL	95,00	1	076730005
XXXL	95,00	1	076730006



7867B

gilet leggero da lavoro
in T/C twill 180 g con inserti in Oxford, blu

CE



	€		
XS	49,00	1	078670700
S	49,00	1	078670701
M	49,00	1	078670702
L	49,00	1	078670703
XL	49,00	1	078670704
XXL	49,00	1	078670705
XXXL	49,00	1	078670706
XXXXL	49,00	1	078670707
5XL	49,00	1	078670708

7867G

gilet leggero da lavoro
in T/C twill 180 g con inserti in Oxford, grigio

CE



	€		
XS	49,00	1	078670800
S	49,00	1	078670801
M	49,00	1	078670802
L	49,00	1	078670803
XL	49,00	1	078670804
XXL	49,00	1	078670805
XXXL	49,00	1	078670806
XXXXL	49,00	1	078670807
5XL	49,00	1	078670808

7907G

gilet da lavoro
in T/C canvas 260 g con inserti in Oxford,
grigio

CE

Beta EASY



Dimensione	€	Articolo
XS	54,50	1 079070800
S	54,50	1 079070801
M	54,50	1 079070802
L	54,50	1 079070803
XL	54,50	1 079070804
XXL	54,50	1 079070805
XXXL	54,50	1 079070806
XXXXL	54,50	1 079070807

7937MG

gilet da lavoro in 97% cotone 3% tessuto
elasticizzato, 220 g/m², grigio

CE

Cotton



Dimensione	€	Articolo
XS	55,50	1 079370400
S	55,50	1 079370401
M	55,50	1 079370402
L	55,50	1 079370403
XL	55,50	1 079370404
XXL	55,50	1 079370405
XXXL	55,50	1 079370406

JACKETS



7658CM

giacca softshell 94% poliestere, 6% spandex,
290 g, camouflage grigio
Dotato di membrana TPU impermeabile,
antivento e traspirante
(resistenza a colonne d'acqua 8.000 mm -
traspirabilità 8.000 mvp)

TOP line



Dimensione	€	Articolo
S	118,00	1 076580101
M	118,00	1 076580102
L	118,00	1 076580103
XL	118,00	1 076580104
XXL	118,00	1 076580105
XXXL	118,00	1 076580106

7659N

giacca softshell 94% poliestere, 6% spandex, 290
g con cappuccio e maniche staccabili, nero
Dotato di membrana TPU impermeabile, antivento
e traspirante (resistenza a colonne d'acqua 8.000
mm - traspirabilità 8.000 mvp)

TOP line



Dimensione	€	Articolo
S	152,00	1 076590001
M	152,00	1 076590002
L	152,00	1 076590003
XL	152,00	1 076590004
XXL	152,00	1 076590005
XXXL	152,00	1 076590006

7669N

giacca da lavoro leggera, multitasche,
elasticizzata, 86% Nylon, 14% spandex, 140
g, nero
Con maniche staccabili e cappuccio a
scomparsa.
Resistente all'acqua, antivento

4-WAY
STRETCH

TOP line



Dimensione	€	Articolo
XS	106,00	1 076690000
S	106,00	1 076690001
M	106,00	1 076690002
L	106,00	1 076690003
XL	106,00	1 076690004
XXL	106,00	1 076690005
XXXL	106,00	1 076690006

7670G

giaccone in poliestere Oxford 300D
impermeabilizzato, con spalmatura in PU,
grigio antracite
Dotato di cappuccio staccabile e rinforzi sulle
maniche.
Impermeabile, antivento e traspirante
(resistenza a colonne d'acqua 2.000 mm -
traspirabilità 2.000 mvp)
Fodera in poliestere 210T, imbottitura in
poliestere 120 g corpo, 100 g maniche

CE

TOP line



Dimensione	€	Articolo
S	106,00	1 076700001
M	106,00	1 076700002
L	106,00	1 076700003
XL	106,00	1 076700004
XXL	106,00	1 076700005
XXXL	106,00	1 076700006

Beta

Beta



7674NG

piumino da lavoro con imbottitura in **GRAPHENE 80 g**, parte frontale e dell'avambraccio rinforzata in tessuto softshell 96% poliestere, 4% spandex, parte retro e maniche in 100% nylon 20D **grigio antracite (fronte), nero (retro)** polsini elasticizzati Antistatico, antibatterico, antivento, termoregolatore

CE
TOP
live



	€		
S	118,00	1	076740001
M	118,00	1	076740002
L	118,00	1	076740003
XL	118,00	1	076740004
XXL	118,00	1	076740005
XXXL	118,00	1	076740006

7780QN

bomber da lavoro multitasche in doppio materiale. 100% nylon impermeabilizzato 300D e tessuto softshell 96% poliestere, 4% spandex, imbottitura in poliestere 160 g con cappuccio fisso nero/grigio antracite

CE



	€		
S	126,00	1	077800201
M	126,00	1	077800202
L	126,00	1	077800203
XL	126,00	1	077800204
XXL	126,00	1	077800205
XXXL	126,00	1	077800206

7750N

bomber da lavoro multitasche in 100% poliestere, imbottitura in 100% poliestere 120 g nero

CE



	€		
XS	79,50	1	077500000
S	79,50	1	077500001
M	79,50	1	077500002
L	79,50	1	077500003
XL	79,50	1	077500004
XXL	79,50	1	077500005
XXXL	79,50	1	077500006
XXXXL	79,50	1	077500007

FLEECE



7636N

micropile con zip corta 180 g/m² nero con dettagli reflex



	€		
XS	26,00	1	076360500
S	26,00	1	076360501
M	26,00	1	076360502
L	26,00	1	076360503
XL	26,00	1	076360504
XXL	26,00	1	076360505
XXXL	26,00	1	076360506

7637G

felpa tecnica zip lunga 250 g, c/cappuccio fleece 100% poliestere con inserti in tessuto softshell 100D con fleece accoppiato 270 g **grigio melange/nero**



	€		
XS	84,00	1	076370000
S	84,00	1	076370001
M	84,00	1	076370002
L	84,00	1	076370003
XL	84,00	1	076370004
XXL	84,00	1	076370005
XXXL	84,00	1	076370006

7642G

felpa girocollo 240 g/m², 60% cotone, 40% poliestere **grigio melange e inserti neri**



	€		
XS	32,00	1	076420000
S	32,00	1	076420001
M	32,00	1	076420002
L	32,00	1	076420003
XL	32,00	1	076420004
XXL	32,00	1	076420005
XXXL	32,00	1	076420006

7654B

micropile zip corta elasticizzato 180 g, blu 95% poliestere, 5% spandex

4-WAY STRETCH

TOP
live



	€		
XS	45,00	1	076540100
S	45,00	1	076540101
M	45,00	1	076540102
L	45,00	1	076540103
XL	45,00	1	076540104
XXL	45,00	1	076540105
XXXL	45,00	1	076540106

7654N
micropile zip corta elasticizzato 180 g, nero
95% poliestere, 5% spandex



TOP
line



taglia	€	colore	codice
XS	45,00	1	076540000
S	45,00	1	076540001
M	45,00	1	076540002
L	45,00	1	076540003
XL	45,00	1	076540004
XXL	45,00	1	076540005
XXXL	45,00	1	076540006

7657B
pile zip lunga elasticizzato 280 g, blu
95% poliestere, 5% spandex



TOP
line



taglia	€	colore	codice
XS	57,50	1	076570100
S	57,50	1	076570101
M	57,50	1	076570102
L	57,50	1	076570103
XL	57,50	1	076570104
XXL	57,50	1	076570105
XXXL	57,50	1	076570106

7657N
pile zip lunga elasticizzato 280 g, nero
95% poliestere, 5% spandex



TOP
line



taglia	€	colore	codice
XS	57,50	1	076570000
S	57,50	1	076570001
M	57,50	1	076570002
L	57,50	1	076570003
XL	57,50	1	076570004
XXL	57,50	1	076570005
XXXL	57,50	1	076570006

7664G
felpa con zip lunga 280 g, grigio
60% cotone, 40% poliestere

TOP
line



taglia	€	colore	codice
XS	52,50	1	076640100
S	52,50	1	076640101
M	52,50	1	076640102
L	52,50	1	076640103
XL	52,50	1	076640104
XXL	52,50	1	076640105
XXXL	52,50	1	076640106

7664N
felpa zip lunga 280 g, nero
60% cotone, 40% poliestere

TOP
line



taglia	€	colore	codice
XS	52,50	1	076640000
S	52,50	1	076640001
M	52,50	1	076640002
L	52,50	1	076640003
XL	52,50	1	076640004
XXL	52,50	1	076640005
XXXL	52,50	1	076640006

7665G
felpa zip lunga, con cappuccio 280 g, grigio
60% cotone, 40% poliestere

TOP
line



taglia	€	colore	codice
XS	56,50	1	076650100
S	56,50	1	076650101
M	56,50	1	076650102
L	56,50	1	076650103
XL	56,50	1	076650104
XXL	56,50	1	076650105
XXXL	56,50	1	076650106

7665N
felpa zip lunga, con cappuccio 280 g, nero
60% cotone, 40% poliestere

TOP
line



taglia	€	colore	codice
XS	56,50	1	076650000
S	56,50	1	076650001
M	56,50	1	076650002
L	56,50	1	076650003
XL	56,50	1	076650004
XXL	56,50	1	076650005
XXXL	56,50	1	076650006

SHIRT &
T-SHIRT

7545F
camicia da lavoro a quadretti in flanella,
in 100% cotone, 190 g.



taglia	€	colore	codice
XS	40,00	1	075450200
S	40,00	1	075450201
M	40,00	1	075450202
L	40,00	1	075450203
XL	40,00	1	075450204
XXL	40,00	1	075450205
XXXL	40,00	1	075450206

7547AZ
polo 3 bottoni
in 100% cotone 200 g, azzurro



taglia	€	colore	codice
XS	29,00	2	075470500
S	29,00	2	075470501
M	29,00	2	075470502
L	29,00	2	075470503
XL	29,00	2	075470504
XXL	29,00	2	075470505
XXXL	29,00	2	075470506

7547BL
 polo 3 bottoni
 in 100% cotone 200 g, blu



	€		
XS	29,00	2	075470200
S	29,00	2	075470201
M	29,00	2	075470202
L	29,00	2	075470203
XL	29,00	2	075470204
XXL	29,00	2	075470205
XXXL	29,00	2	075470206

7547G
 polo 3 bottoni
 in 100% cotone 200 g, grigio



	€		
XS	29,00	2	075470300
S	29,00	2	075470301
M	29,00	2	075470302
L	29,00	2	075470303
XL	29,00	2	075470304
XXL	29,00	2	075470305
XXXL	29,00	2	075470306

7547N
 polo 3 bottoni
 in 100% cotone 200 g, nero



	€		
XS	29,00	2	075470400
S	29,00	2	075470401
M	29,00	2	075470402
L	29,00	2	075470403
XL	29,00	2	075470404
XXL	29,00	2	075470405
XXXL	29,00	2	075470406

7547R
 polo 3 bottoni
 in 100% cotone 200 g, rosso



	€		
XS	29,00	2	075470600
S	29,00	2	075470601
M	29,00	2	075470602
L	29,00	2	075470603
XL	29,00	2	075470604
XXL	29,00	2	075470605
XXXL	29,00	2	075470606

7548M
 t-shirt con stampa moderna, 100% cotone,
 150 g/m², nero



	€		
XS	25,00	1	075480400
XL	25,00	1	075480404
S	25,00	1	075480401
M	25,00	1	075480402
L	25,00	1	075480403
XXL	25,00	1	075480405
XXXL	25,00	1	075480406

7548C
 t-shirt con stampa classica, 100% cotone,
 150 g/m², nero



	€		
XS	25,00	1	075480500
S	25,00	1	075480501
M	25,00	1	075480502
L	25,00	1	075480503
XL	25,00	1	075480504
XXL	25,00	1	075480505
XXXL	25,00	1	075480506

7549AZ
 t-shirt work in 100% cotone 150 g, azzurro



	€		
XS	19,00	5	075490500
S	19,00	5	075490501
M	19,00	5	075490502
L	19,00	5	075490503
XL	19,00	5	075490504
XXL	19,00	5	075490505
XXXL	19,00	5	075490506

7549BL
 t-shirt work in 100% cotone 150 g, blu



	€		
XS	19,00	5	075490200
S	19,00	5	075490201
M	19,00	5	075490202
L	19,00	5	075490203
XL	19,00	5	075490204
XXL	19,00	5	075490205
XXXL	19,00	5	075490206

7549G
 t-shirt work in 100% cotone 150 g, grigio



	€		
XS	19,00	5	075490300
S	19,00	5	075490301
M	19,00	5	075490302
L	19,00	5	075490303
XL	19,00	5	075490304
XXL	19,00	5	075490305
XXXL	19,00	5	075490306

7549NE
t-shirt work in 100% cotone 150 g, nero



Taglie	€	Quantità	Articolo
XS	19,00	5	075490700
S	19,00	5	075490701
M	19,00	5	075490702
L	19,00	5	075490703
XL	19,00	5	075490704
XXL	19,00	5	075490705
XXXL	19,00	5	075490706

7549N
t-shirt work in 100% cotone 150 g, nero



Taglie	€	Quantità	Articolo
XS	19,00	5	075490400
S	19,00	5	075490401
M	19,00	5	075490402
L	19,00	5	075490403
XL	19,00	5	075490404
XXL	19,00	5	075490405
XXXL	19,00	5	075490406

7549R
t-shirt work in 100% cotone 150 g, rosso



Taglie	€	Quantità	Articolo
XS	19,00	5	075490600
S	19,00	5	075490601
M	19,00	5	075490602
L	19,00	5	075490603
XL	19,00	5	075490604
XXL	19,00	5	075490605
XXXL	19,00	5	075490606

7550G
t-shirt tecnica da lavoro in poliestere, 120 g con tecnologia 37.5°, grigio con dettagli neri, arancioni e reflex



Taglie	€	Quantità	Articolo
XS	40,50	1	075500400
S	40,50	1	075500401
M	40,50	1	075500402
L	40,50	1	075500403
XL	40,50	1	075500404
XXL	40,50	1	075500405
XXXL	40,50	1	075500406

7550N
t-shirt tecnica da lavoro in poliestere, 120 g con tecnologia 37.5°, nero con dettagli grigi, arancioni e reflex



Taglie	€	Quantità	Articolo
XS	40,50	1	075500500
S	40,50	1	075500501
M	40,50	1	075500502
L	40,50	1	075500503
XL	40,50	1	075500504
XXL	40,50	1	075500505
XXXL	40,50	1	075500506

7557BL
polo a maniche lunghe, 3 bottoni in 100% cotone 200 g, blu



Taglie	€	Quantità	Articolo
XS	34,50	1	075570200
S	34,50	1	075570201
M	34,50	1	075570202
L	34,50	1	075570203
XL	34,50	1	075570204
XXL	34,50	1	075570205
XXXL	34,50	1	075570206



7970
pantaloni impermeabili in PVC Tricot, blu
DISPONIBILE FINO AD ESAURIMENTO SCORTE

CE



EN 343

Taglie	€	Quantità	Articolo
XS	44,00	1	079700000
S	44,00	1	079700001
M	44,00	1	079700002
L	44,00	1	079700003
XL	44,00	1	079700004
XXL	44,00	1	079700005
XXXL	44,00	1	079700006



7971L

pantaloni impermeabili in poliestere spalmato PVC
 con cuciture termonastrate, blu
 Dotato di elastico in vita e fondo gamba regolabile con bottoni automatici

CE



EN 343

	€		
XS	24,60	1	079710100
S	24,60	1	079710101
M	24,60	1	079710102
L	24,60	1	079710103
XL	24,60	1	079710104
XXL	24,60	1	079710105
XXXL	24,60	1	079710106

7979

giacca impermeabile in PVC Tricot,
 blu
 DISPONIBILE FINO AD ESAURIMENTO SCORTE

CE



EN 343

	€		
S	72,00	1	079790001
M	72,00	1	079790002
L	72,00	1	079790003
XL	72,00	1	079790004
XXL	72,00	1	079790005
XXXL	72,00	1	079790006

UNDERWEAR

7978L

cappotto impermeabile in poliestere spalmato PVC con cappuccio fisso e cuciture termonastrate, blu
 dotato di bottoni automatici che permettono di accorciarlo a 3/4

CE



EN 343

	€		
XS	34,00	1	079780100
S	34,00	1	079780101
M	34,00	1	079780102
L	34,00	1	079780103
XL	34,00	1	079780104
XXL	34,00	1	079780105
XXXL	34,00	1	079780106

7996N

set abbigliamento intimo tecnico maglia intima tecnica maniche lunghe + calzamaglia intima tecnica, 92% poliestere, 8%spandex, 160 g/m², nero



	€		
XS-S	41,00	1	079960000
M-L	41,00	1	079960002
XL-XXL	41,00	1	079960004



ACCESSORIES

7800G

coppia ginocchieri da lavoro



7800G € 14,70 1 078000500

7980L

berretto invernale con luce LED ricaricabile, con risvolto in 100% acrilico
luce LED con 3 intensità luminose, fino a 60 Lumen
taglia unica
nero

- Ricaricabile tramite attacco USB
- Intensità luminosa: fino a 60 Lumen
- Tempo di ricarica: 80 minuti
- Autonomia: 85 ÷ 290 minuti



7980L € 14,10 10 079800200

7980NC

berretto invernale in pile, 100% poliestere, reversibile (double face), nero - camouflage



7980NC € 12,90 10 079800112

7980RN

berretto invernale con risvolto in 100% acrilico interno foderato con **3M Thinsulate™**, taglia unica
nero



7980RN € 12,10 10 079800120

7981N

cappellino anti pioggia
100% nylon spalmato PU
con trattamento water repellent,
nero



L = Ø 58 cm € 21,10 1 079810158
XL = Ø 60 cm € 21,10 1 079810160

7982N

cappellino con visiera curva, 100% cotone,
chiusura con cinturino,
nero



7982N € 9,90 10 079820000

7984EG

cintura da lavoro in tessuto elasticizzato e fibbia ad uncino in metallo zinco satinato,
taglia unica 120 cm accorciabile, larghezza 37 mm,
grigia



7984EG € 24,90 1 079840520

7984G

cintura da lavoro in 100% TPE e fibbia in metallo zinco cromato
taglia unica 125 cm accorciabile, larghezza 35 mm,
nero



7984G € 17,20 1 079840525

7985N

scaldacollo in micropile con regolatore a coulisse,
utilizzabile anche come berretto
nero con dettagli grigi e reflex



7985N € 12,10 10 079850000



7104 90

colonnine in plastica con base riempibile



7104 90 H mm 90 € 27,00 4 071040004

7105 6

catena plastica di delimitazione



7105 6 Ø mm 6 L m 25 € 65,00 1 071050006

7109A

cartelli di avvertenza in alluminio



	H mm	€		
7109A 1	140	11,30	1	071090001
7109A 2	140	11,30	1	071090002
7109A 3	140	11,30	1	071090003
7109A 4	140	11,30	1	071090004

7109D

cartelli di divieto



	H mm	€		
7109D 1	115	11,30	1	071090051
7109D 2	115	11,30	1	071090052
7109D 3	115	11,30	1	071090053

7061TC

occhiali di protezione con lenti in policarbonato trasparente

CE **EASY**



EN166:2001
EN170
2C-1.2 1F

7061TC € 9,50 1 070610001

7076BC

occhiali di protezione con lenti in policarbonato trasparente

CE **SPORT**



EN166:2001
EN172
5-1.7 1F

7076BC € 21,70 1 070760009

7076BD

occhiali di protezione con lenti in policarbonato scuro

CE **SPORT**



EN166:2001
EN172
5-3.1 1F

7076BD € 21,70 1 070760019

7076BP

occhiali di protezione con lenti in policarbonato polarizzato scuro

CE **SPORT**



EN ISO 12312-1:2013+A1:2015
EN 1836
3P

7076BP € 34,50 1 070760029

7076BU

occhiali di protezione con lenti in policarbonato arancioni

CE



EN ISO 12311:2013
UV 500

7076BU € 17,80 1 070760039

7093BC

occhiali di protezione con lenti in policarbonato trasparente

CE **IMPACT**



EN166:2001
EN170
2C-1.2 1F

7093BC € 32,50 1 070930009

7093BD

occhiali di protezione con lenti in policarbonato scuro

CE **IMPACT**



EN166:2001
EN172
5-3.1 1F

7093BD € 32,50 1 070930019



C62M/WW

espositore a manichino, dimensioni realistiche, base in metallo



185 cm

C62M/WW € 251,00 1 062000362

C64

parete espositiva vuota abbigliamento e calzature



2400 mm

560 mm

L	€	
1 m	1.405,00	1 064000021
2 m	2.550,00	1 064000022
3 m	3.690,00	1 064000023
4 m	4.830,00	1 064000024

C64G

gondola espositiva vuota abbigliamento e calzature

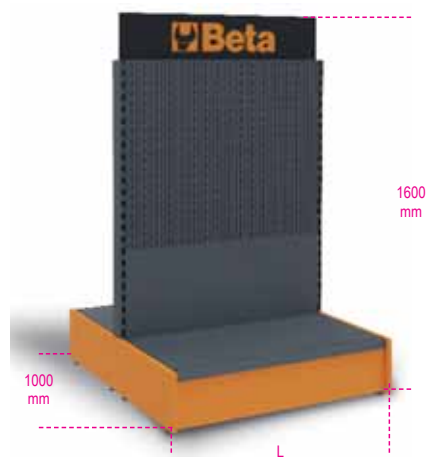

L	€		
1 m	1.730,00	1	064000051
2 m	3.140,00	1	064000052

C64CW

camerino



C64CW	€		
	598,00	1	064000610

6200AP/S10

set da 10 grucce



6200AP/S10	€		
	43,00	1	062000331

6800BA

barra abbigliamento



6800BA	€		
	125,50	1	068000130

6800RS

rastrelliera scarpe



6800RS	€		
	108,00	1	068000135

6888GS

gancio scarpe per espositore C64



6888GS	€		
	27,00	2	068880122
			170x120 mm

6888GW

gancio per espositore C64



6888GW	€		
	7,50	2	068880121
			400 mm

9562TB

tappeto prova calzature,
con retro gommato antiscivolo



9562TB	L	H	€		
	800	600	49,50	1	095620500

9565S

seduta in lamiera d'acciaio
con sedile in ecopelle sfoderabile



9565S	H	ø	€		
	60	38	219,00	1	095650300

Beta



Robur

Dal 1930, Robur produce linee di accessori per funi allineandosi alla riconosciuta qualità di Beta Utensili, di cui è complemento produttivo.

Esperienza, organizzazione e tecnologia sono i requisiti di un continuo sviluppo determinato dall'attenzione alle esigenze del mercato.

Dal 1984, Robur ha sede in un moderno stabilimento a Sulmona.

 **Confezioni speciali per libero servizio**

CARICHI

WLL: carico massimo di esercizio (per accessori di sollevamento)

WFL: forza limite di lavoro (per accessori non destinati al sollevamento)

BF: forza massima raggiunta dall'articolo durante la prova di trazione statica

LC: tensione di ancoraggio

novità 2024

8134

Sollevatori magnetici permanenti

CE

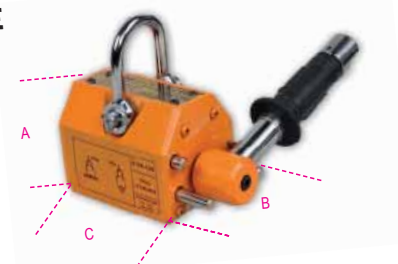

EN13155

Dati tecnici:

- Coefficiente di sicurezza: 3
- Piastra di identificazione seriale

Certificati disponibili:

- Certificato del Fabbricante
- Dichiarazione di Conformità CE
- Rapporto di Prova tipo 2.2 UNI EN10204
- Manuale d'uso e manutenzione

misura

numero utensili nella confezione

prezzo unitario

numero codice

WLL kg	A mm	B mm	C mm	€	numero utensili nella confezione	numero codice
100	70	64	92	457,00	1	081340010
300	96	88	165	802,00	1	081340030
600	120	118	230	1.490,00	1	081340060
1000	168	168	264	2.465,00	1	081340100

8105
tenditori a due occhi ad alta resistenza
zincati a caldo

CE

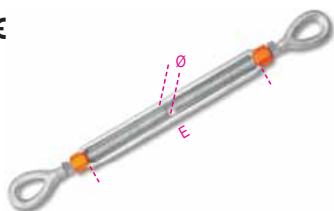

DATI TECNICI

- coefficiente di sicurezza: 5
- trattamento termico canaula: normalizzazione
- trattamento termico anelli: bonifica
- codice lotto di fabbricazione

ANALISI DI LABORATORIO

- analisi chimica
- test di trazione
- carico di collaudo 2 x WFL

CERTIFICATI DISPONIBILI

- Specifica Prodotto
- Rapporto di Prova tipo 2.2 UNI EN10204
- Certificato di Controllo tipo 3.1 UNI EN10204
- Dichiarazione di Conformità CE

ØxE "	≈ mm	WLL kg	€	📦	🚚
3/8x6	M10x150	540	14,40	5	081050010
1/2x6	M12x150	1000	23,70	5	081050011
1/2x9	M12x230	1000	30,50	5	081050012
5/8x6	M16x150	1590	36,50	2	081050014
5/8x9	M16x230	1590	45,00	2	081050016
5/8x12	M16x300	1590	54,00	2	081050015
3/4x6	M20x150	2360	58,00	2	081050017
3/4x9	M20x230	2360	67,50	2	081050020
3/4x12	M20x300	2360	80,50	2	081050018
3/4x18	M20x460	2360	106,00	2	081050021
7/8x12	M22x300	3270	114,00	1	081050022
1x6	M24x150	4540	121,00	1	081050024
1x12	M24x300	4540	174,00	1	081050025
1x18	M24x460	4540	204,50	1	081050026
1.1/4x12	M33x300	6900	297,00	1	081050031
1.1/4x18	M33x460	6900	306,00	1	081050032
1.1/4x24	M33x610	6900	415,00	1	081050033
1.1/2x12	M39x300	9710	367,00	1	081050034
1.1/2x18	M39x460	9710	446,00	1	081050035
1.3/4x18	M45x460	12700	675,00	1	081050036

confezioni appendibili



ØxE "	📦	€	🚚
3/8x6	1	15,70	1
1/2x9	1	32,00	1



8109
tenditori a due forcelle ad alta resistenza
zincati a caldo

CE

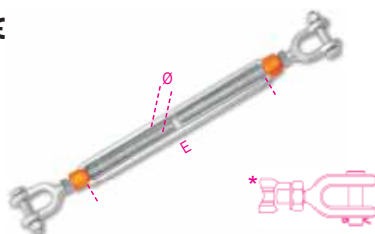

DATI TECNICI

- coefficiente di sicurezza: 5
- trattamento termico canaula: normalizzazione
- trattamento termico anelli: bonifica
- codice lotto di fabbricazione

ANALISI DI LABORATORIO

- analisi chimica
- test di trazione

CERTIFICATI DISPONIBILI

- Specifica Prodotto
- Rapporto di Prova tipo 2.2 UNI EN10204
- Certificato di Controllo tipo 3.1 UNI EN10204
- Dichiarazione di Conformità CE

ØxE "	≈ mm	WLL kg	€	📦	🚚
3/8x6	M10x150	540	18,70	5	081090010
1/2x6	M12x150	1000	31,00	5	081090011
1/2x9	M12x230	1000	37,00	5	081090012
1/2x12	M12x300	1000	47,00	5	081090013
5/8x6	M16x150	1590	56,50	2	081090015
5/8x9	M16x230	1590	67,00	2	081090016
5/8x12	M16x300	1590	75,00	2	081090017
3/4x6	M20x150	2360	79,00	2	081090018
3/4x9	M20x230	2360	91,50	2	081090020
3/4x12	M20x300	2360	102,00	2	081090019
3/4x18	M20x460	2360	121,50	2	081090021
7/8x12	M22x300	3270	153,00	1	081090022
7/8x18	M22x460	3270	185,00	1	081090023
1x6	M24x150	4540	151,50	1	081090024
1x12	M24x300	4540	217,50	1	081090025
1x18	M24x460	4540	251,00	1	081090026
* 1.1/4x12	M33x300	6900	353,00	1	081090031
* 1.1/4x18	M33x460	6900	396,00	1	081090032
* 1.1/4x24	M33x610	6900	549,00	1	081090033
* 1.1/2x12	M39x300	9710	512,00	1	081090034
* 1.1/2x18	M39x460	9710	586,00	1	081090038
* 1.1/2x24	M39x610	9710	702,00	1	081090039
* 1.3/4x18	M45x460	12700	854,00	1	081090036

confezioni appendibili



ØxE "	📦	€	🚚
3/8x6	1	20,00	1
1/2x9	1	38,00	1

8110
tenditori ad occhio e forcella ad alta resistenza
zincati a caldo

CE



DATI TECNICI

- coefficiente di sicurezza: 5
- trattamento termico canaula: normalizzazione
- trattamento termico anelli: bonifica
- codice lotto di fabbricazione

ANALISI DI LABORATORIO

- analisi chimica
- test di trazione

CERTIFICATI DISPONIBILI

- Specifica Prodotto
- Rapporto di Prova tipo 2.2 UNI EN10204
- Certificato di Controllo tipo 3.1 UNI EN10204
- Dichiarazione di Conformità CE

ØxE "	≈ mm	WLL kg	€	📦	🚚
3/8x6	M10x150	540	17,00	5	081100004
1/2x6	M12x150	1000	27,00	5	081100006
1/2x9	M12x230	1000	33,50	5	081100010
5/8x6	M16x150	1590	47,00	2	081100014
5/8x9	M16x230	1590	55,00	2	081100015
5/8x12	M16x300	1590	64,00	2	081100016
3/4x6	M20x150	2360	69,50	2	081100019
3/4x9	M20x230	2360	80,00	2	081100020
3/4x12	M20x300	2360	91,00	2	081100021
7/8x12	M22x300	3270	133,00	1	081100022
1x6	M24x150	4540	136,50	1	081100027
1x12	M24x300	4540	195,50	1	081100029
* 1.1/4x12	M33x300	6900	326,00	1	081100034
* 1.1/4x18	M33x460	6900	387,00	1	081100035
* 1.1/4x24	M33x610	6900	480,00	1	081100036
* 1.1/2x12	M39x300	9710	457,00	1	081100038
* 1.1/2x18	M39x460	9710	518,00	1	081100039
* 1.3/4x18	M45x460	12700	790,00	1	081100044

* forcella con perno passante e copiglia



TENDITORI



L'originale design degli storici tenditori **Robur** è tra i più apprezzati dai progettisti e strutturisti italiani, in virtù delle precise tolleranze dimensionali, dei valori di resistenza superiori ai modelli DIN 1480 e della tracciabilità garantita dal produttore e dal codice identificativo sulla canala.

La zincatura elettrolitica di alta qualità, con deposito uniforme e privo di cromo esavalente, garantisce resistenza agli agenti atmosferici e aspetto curato per incorporazioni strutturali a vista.



8005Z

tenditori a due occhi zincati

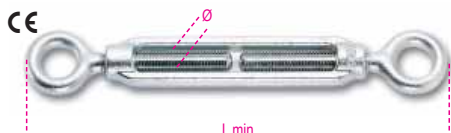

DATI TECNICI

- coefficiente di sicurezza: 4
- ANALISI DI LABORATORIO
- analisi chimica
- test di trazione
- CERTIFICATI DISPONIBILI
- Specifica Prodotto
- Rapporto di Prova tipo 2.2 UNI EN10204
- Dichiarazione di Conformità CE

Ø mm	≈	L min mm	WFL kg	€	📦	🚚
M5	3/16	118	115	2,40	400	080050105
M6	1/4	130	160	2,65	300	080050106
M8	5/16	158	300	4,05	200	080050108
M10	3/8	192	470	5,80	100	080050110
M11	7/16	206	580	7,60	80	080050111
M12	1/2	226	690	8,90	60	080050112
M14	9/16	256	940	12,20	15	080050114
M16	5/8	290	1290	18,40	10	080050116
M18	11/16	358	1660	27,00	1	080050118
M20	3/4	358	2130	30,50	1	080050120
M22	7/8	400	2630	42,00	1	080050122
M24	1"	436	3060	52,50	1	080050124
M27	1 1/8	474	4000	76,50	1	080050125
M30	1 3/16	498	4860	92,50	1	080050130
M33	1 1/4	516	6040	107,50	1	080050126
M36	1 3/8	532	6500	133,50	1	080050136
M39	1 1/2	544	7900	157,50	1	080050139

confezioni speciali



Ø mm	≈	📦	€	🚚	🚚
M5	3/16	30	81,00	1	080050705
M6	1/4	30	89,50	1	080050706
M8	5/16	20	91,00	1	080050708
M10	3/8	15	98,00	1	080050710
M11	7/16	15	128,00	1	080050711
M12	1/2	15	150,00	1	080050712

confezioni appendibili



Ø mm	📦	€	🚚	🚚
M5	2	5,65	1	080059305
M6	2	6,45	1	080059306
M8	1	5,35	1	080059108
M10	1	7,05	1	080059110
M11	1	9,15	1	080059111
M12	1	10,20	1	080059112
M14	1	13,20	1	080059114
M16	1	19,70	1	080059116

8005TZ

tenditori a due occhi FORGIATI A CALDO canala a tubo DIN 1478 zincati



DATI TECNICI

- coefficiente di sicurezza: 4
- ANALISI DI LABORATORIO
- analisi chimica
- test di trazione
- CERTIFICATI DISPONIBILI
- Specifica Prodotto
- Rapporto di Prova tipo 2.2 UNI EN10204
- Dichiarazione di Conformità CE

Ø mm	≈	WFL kg	€	📦	🚚
M12	1/2	690	12,10	15	080050512
M16	5/8	1290	20,80	1	080050516
M20	3/4	2130	30,00	1	080050520
M24	1"	3060	54,50	1	080050524
M27	1 1/8	4000	74,00	1	080050527
M30	1 3/16	4860	85,50	1	080050530
M36	1 3/8	6500	137,00	1	080050536

confezioni appendibili



Ø mm	📦	€	🚚	🚚
M12	1	14,40	1	080059512



Robur

8006Z

tenditori ad occhio e gancio zincati

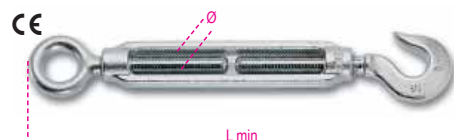

DATI TECNICI

- coefficiente di sicurezza: 4
- ANALISI DI LABORATORIO
- analisi chimica
- test di trazione
- CERTIFICATI DISPONIBILI
- Specifica Prodotto
- Rapporto di Prova tipo 2.2 UNI EN10204
- Dichiarazione di Conformità CE

Ø mm	≈	L min mm	WFL kg	€	📦	🚚
M5	3/16	121	25	2,55	400	080060105
M6	1/4	132	45	2,80	250	080060106
M8	5/16	170	95	4,25	180	080060108
M10	3/8	204	140	6,30	100	080060110
M11	7/16	221	165	8,25	15	080060111
M12	1/2	244	300	9,75	15	080060112
M14	9/16	284	420	14,00	10	080060114
M16	5/8	322	570	20,70	1	080060116
M18	11/16	373	700	30,00	1	080060118
M20	3/4	391	900	36,00	1	080060120
M22	7/8	433	1100	48,00	1	080060122
M24	1"	470	1300	64,50	1	080060124
M27	1 1/8	503	2300	88,00	1	080060127

confezioni speciali



Ø mm	≈	📦	€	🚚	🚚
M5	3/16	30	86,00	1	080060705
M6	1/4	30	94,50	1	080060706
M8	5/16	20	95,50	1	080060708
M10	3/8	15	106,50	1	080060710

confezioni appendibili



Ø mm	📦	€	🚚	🚚
M5	2	6,40	1	080069305
M6	2	7,15	1	080069306
M8	1	5,45	1	080069108
M10	1	7,45	1	080069110
M11	1	9,55	1	080069111
M12	1	10,80	1	080069112
M14	1	15,50	1	080069114

8007Z

tenditori a due ganci
zincati

CE

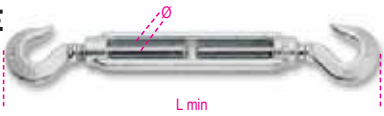

DATI TECNICI

- coefficiente di sicurezza: 4
- ANALISI DI LABORATORIO
- analisi chimica
- test di trazione
- CERTIFICATI DISPONIBILI
- Specifica Prodotto
- Rapporto di Prova tipo 2.2 UNI EN10204
- Dichiarazione di Conformità CE

Ø mm	≈ "	L min mm	WFL kg	€		
M5	3/16	124	25	2,70	30	080070105
M6	1/4	134	45	2,95	30	080070106
M8	5/16	181	95	4,50	20	080070108
M10	3/8	211	140	6,80	15	080070110
M11	7/16	231	165	8,90	15	080070111
M12	1/2	262	300	10,70	15	080070112
M14	9/16	312	420	15,90	1	080070114
M16	5/8	354	570	22,90	1	080070116
M18	11/16	388	700	32,50	1	080070118
M20	3/4	424	900	42,00	1	080070120
M22	7/8	466	1100	54,00	1	080070122
M24	1"	504	1300	76,50	1	080070124
M27	1 1/8	532	2300	99,50	1	080070127

confezioni appendibili

Ø mm	≈ "	€		
M5	2	6,70	1	080079305
M6	2	7,15	1	080079306
M8	1	5,40	1	080079108
M10	1	7,30	1	080079110
M11	1	9,90	1	080079111
M12	1	11,70	1	080079112

8008N

tenditori a due tronchi
neri

CE

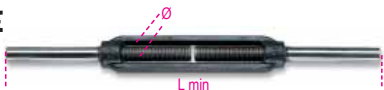

DATI TECNICI

- coefficiente di sicurezza: 4
- ANALISI DI LABORATORIO
- analisi chimica
- test di trazione
- CERTIFICATI DISPONIBILI
- Specifica Prodotto
- Rapporto di Prova tipo 2.2 UNI EN10204
- Dichiarazione di Conformità CE

Ø mm	≈ "	L min mm	WFL kg	€		
M5	3/16	160	115	2,35	30	080080205
M6	1/4	180	160	2,60	30	080080206
M8	5/16	210	300	3,60	20	080080208
M10	3/8	250	470	4,85	15	080080210
M12	1/2	280	690	7,20	15	080080212
M14	9/16	340	940	10,10	5	080080214
M16	5/8	380	1290	13,60	5	080080216
M18	11/16	410	1660	20,20	3	080080218
M20	3/4	440	2130	23,90	3	080080220
M22	7/8	480	2630	30,00	2	080080222
M24	1"	520	3060	39,00	2	080080224
M27	1 1/8	560	4000	61,00	1	080080227
M30	1 3/16	560	4860	76,50	1	080080230
M33	1 1/4	600	6040	82,00	1	080080233
M36	1 3/8	600	6500	106,00	1	080080236
M39	1 1/2	600	7900	121,00	1	080080239

confezioni appendibili



Ø mm	≈ "	€		
M5	2	6,50	1	080089305
M6	2	6,60	1	080089306
M8	1	4,85	1	080089208
M10	1	6,40	1	080089210
M12	1	8,10	1	080089212
M14	1	11,30	1	080089214

8008TZN

tenditori a due tronchi
canaula a tubo DIN 1478
terminali neri, corpo zincato

CE



DATI TECNICI

- coefficiente di sicurezza: 4
- ANALISI DI LABORATORIO
- analisi chimica
- test di trazione
- CERTIFICATI DISPONIBILI
- Specifica Prodotto
- Rapporto di Prova tipo 2.2 UNI EN10204
- Dichiarazione di Conformità CE

Ø mm	≈ "	WFL kg	€		
M12	1/2	690	9,95	10	080080512
M16	5/8	1290	16,40	1	080080516
M20	3/4	2130	24,20	1	080080520
M24	1	3060	42,50	1	080080524
M27	1.1/8	4000	62,00	1	080080527
M30	1.3/16	4860	73,50	1	080080530
M36	1.3/8	6500	115,50	1	080080536

8009Z

tenditori a due forcelle
zincati

CE



DATI TECNICI

- coefficiente di sicurezza: 4
- ANALISI DI LABORATORIO
- analisi chimica
- test di trazione
- CERTIFICATI DISPONIBILI
- Specifica Prodotto
- Rapporto di Prova tipo 2.2 UNI EN10204
- Dichiarazione di Conformità CE

Ø mm	≈ "	L min mm	WFL kg	€		
M8	5/16	192	300	13,20	15	080090008
M10	3/8	234	470	15,80	15	080090010
M12	1/2	274	690	21,20	15	080090012
M14	9/16	342	940	29,50	1	080090014
M16	5/8	372	1290	34,50	1	080090016
M18	11/16	406	1660	50,50	1	080090018
M20	3/4	406	2130	53,50	1	080090020
M22	7/8	466	2630	74,00	1	080090022
M24	1"	486	3060	86,50	1	080090024
M27	1 1/8	510	4000	135,50	1	080090027
M30	1 3/16	566	4860	174,00	1	080090030

confezioni speciali



Ø mm	≈ "	€		
M8	5/16	74,00	1	080090708
M10	3/8	89,00	1	080090710
M12	1/2	119,00	1	080090712

confezioni appendibili



Ø mm	≈ "	€		
M8	1	15,00	1	080099008
M10	1	17,10	1	080099010
M12	1	23,10	1	080099012

8009TZ

tenditori a due forcelle
canaula a tubo DIN 1478
zincati

CE



DATI TECNICI

- coefficiente di sicurezza: 4
- ANALISI DI LABORATORIO
- analisi chimica
- test di trazione
- CERTIFICATI DISPONIBILI
- Specifica Prodotto
- Rapporto di Prova tipo 2.2 UNI EN10204
- Dichiarazione di Conformità CE

Ø mm	≈ "	WFL kg	€		
M12	1/2	690	23,80	10	080090512
M16	5/8	1290	37,00	1	080090516
M20	3/4	2130	52,50	1	080090520
M24	1	3060	88,00	1	080090524
M27	1.1/8	4000	133,00	1	080090527
M30	1.3/16	4860	167,00	1	080090530

confezioni appendibili



Ø mm	≈ "	€		
M12	1	23,70	1	080099512



8010Z

tenditori ad occhio e forcella zincati



DATI TECNICI

- coefficiente di sicurezza: 4

ANALISI DI LABORATORIO

- analisi chimica
- test di trazione

CERTIFICATI DISPONIBILI

- Specifica Prodotto
- Rapporto di Prova tipo 2.2 UNI EN10204
- Dichiarazione di Conformità CE

Ø mm	≈	L min mm	WFL kg	€	📦	🚚
M8	5/16	175	300	8,65	20	080100008
M10	3/8	215	470	10,80	15	080100010
M12	1/2	250	690	15,10	10	080100012
M14	9/16	299	940	20,80	10	080100014
M16	5/8	331	1290	26,50	1	080100016
M18	11/16	382	1660	38,50	1	080100018
M20	3/4	382	2130	42,00	1	080100020
M22	7/8	433	2630	58,00	1	080100022
M24	1"	461	3060	69,50	1	080100024
M27	1 1/8	492	4000	106,00	1	080100027
M30	1 3/16	529	4860	133,50	1	080100030

confezioni appendibili



Ø mm	📦	€	📦	🚚
M8	1	9,70	1	080109008
M10	1	12,00	1	080109010
M12	1	16,30	1	080109012
M14	1	23,10	1	080109014

8010TZ

tenditori ad occhio e forcella canaule a tubo DIN 1478 zincati



DATI TECNICI

- coefficiente di sicurezza: 4

ANALISI DI LABORATORIO

- analisi chimica
- test di trazione

CERTIFICATI DISPONIBILI

- Specifica Prodotto
- Rapporto di Prova tipo 2.2 UNI EN10204
- Dichiarazione di Conformità CE

Ø mm	≈	WFL kg	€	📦	🚚
M12	1/2	690	17,70	10	080100612
M16	5/8	1290	29,00	1	080100616
M20	3/4	2130	41,50	1	080100620
M24	1	3060	71,00	1	080100624
M27	1.1/8	4000	103,50	1	080100627
M30	1.3/16	4860	126,00	1	080100630

8011Z

tenditori gancio e forcella zincati



DATI TECNICI

- coefficiente di sicurezza: 4

ANALISI DI LABORATORIO

- analisi chimica
- test di trazione

CERTIFICATI DISPONIBILI

- Specifica Prodotto
- Rapporto di Prova tipo 2.2 UNI EN10204
- Dichiarazione di Conformità CE

Ø mm	≈	L min mm	WFL kg	€	📦	🚚
M12	1/2	270	300	13,60	1	080110112
M16	5/8	360	570	28,00	1	080110116
M20	3/4	420	900	46,50	1	080110120
M24	1"	490	1300	78,00	1	080110124
M27	1 1/8	500	2300	108,00	1	080110127

8011TZ

tenditori gancio e forcella canaule a tubo DIN 1478 zincati



DATI TECNICI

- coefficiente di sicurezza: 4

ANALISI DI LABORATORIO

- analisi chimica
- test di trazione

CERTIFICATI DISPONIBILI

- Specifica Prodotto
- Rapporto di Prova tipo 2.2 UNI EN10204
- Dichiarazione di Conformità CE

Ø mm	≈	L min mm	WFL kg	€	📦	🚚
M12	1/2	260	300	15,60	1	080110612
M16	5/8	350	570	28,50	1	080110616
M20	3/4	400	900	43,50	1	080110620
M24	1"	490	1300	75,00	1	080110624
M27	1 1/8	500	2300	99,50	1	080110627

8001Z

canaule per tenditori zincate



DATI TECNICI

- coefficiente di sicurezza: 5

codice lotto di fabbricazione ANALISI DI LABORATORIO

- analisi chimica
- test di trazione

CERTIFICATI DISPONIBILI

- Specifica Prodotto
- Rapporto di Prova tipo 2.2 UNI EN10204
- Certificato di Controllo tipo 3.1 UNI EN10204

• Dichiarazione di Conformità CE

Ø mm	≈	L mm	WFL kg	€	📦	🚚
M5	3/16	80	115	1,44	100	080010105
M6	1/4	80	160	1,51	100	080010106
M8	5/16	105	300	2,37	25	080010108
M10	3/8	125	470	3,05	20	080010110
M11	7/16	135	580	3,75	15	080010111
M12	1/2	140	690	4,05	20	080010112
M14	9/16	170	940	5,70	15	080010114
M16	5/8	190	1290	7,75	15	080010116
M18	11/16	205	1660	12,30	10	080010118

Ø mm	≈	L mm	WFL kg	€	📦	🚚
M20	3/4	220	2130	14,20	10	080010120
M22	7/8	240	2630	18,00	8	080010122
M24	1"	260	3060	22,00	5	080010124
M27	1 1/8	270	4000	34,50	1	080010127
M30	1 3/16	280	4860	43,50	1	080010130
M33	1 1/4	290	6040	48,00	1	080010133
M36	1 3/8	300	6500	61,50	1	080010136
M39	1 1/2	300	7900	73,50	1	080010139

confezioni appendibili



Ø mm	📦	€	📦	🚚
M5	2	4,35	1	080019305
M6	2	4,75	1	080019306
M8	1	3,75	1	080019108
M10	1	4,40	1	080019110
M11	1	5,30	1	080019111
M12	1	5,50	1	080019112
M14	1	7,30	1	080019114
M16	1	9,30	1	080019116
M18	1	13,80	1	080019118
M20	1	15,50	1	080019120
M22	1	19,60	1	080019122
M24	1	23,50	1	080019124

8001TZ

canaule a tubo per tenditori zincate



DIN 1478

DATI TECNICI

- coefficiente di sicurezza: 5

- codice lotto di fabbricazione

ANALISI DI LABORATORIO

- analisi chimica
- test di trazione

CERTIFICATI DISPONIBILI

- Specifica Prodotto
- Rapporto di Prova tipo 2.2 UNI EN10204
- Certificato di Controllo tipo 3.1 UNI EN10204
- Dichiarazione di Conformità CE

Ø mm	≈	L mm	WFL kg	€	📦	🚚
M12	1/2	125	690	6,70	10	080010512
M16	5/8	170	1290	10,20	5	080010516
M20	3/4	200	2130	13,50	5	080010520
M24	1	255	3060	23,70	3	080010524
M27	1.1/8	255	4000	32,00	1	080010527
M30	1.3/16	255	4860	36,00	1	080010530
M36	1.3/8	295	6500	65,00	1	080010536
M42	1.5/8	330	9700	91,50	1	080010542

* misure non contemplate nella norma.

da M12 a M27 acciaio S235JR

da M30 a M42 acciaio S355JR

confezioni appendibili



Ø mm	📦	€	📦	🚚
M12	1	8,05	1	080019512
M16	1	11,30	1	080019516
M20	1	14,70	1	080019520
M24	1	24,60	1	080019524

8002ZD

anelli per tenditori,
filettatura destra, zincati

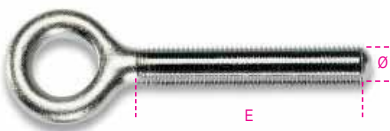

DATI TECNICI

• coefficiente di sicurezza: 4

ANALISI DI LABORATORIO

• analisi chimica

• test di trazione

CERTIFICATI DISPONIBILI

• Specifica Prodotto

• Rapporto di Prova tipo 2.2 UNI EN10204

Ø mm	≈ "	E mm	WFL kg	€		
M5	3/16	37	115	0,50	200	080020105
M6	1/4	40	160	0,61	150	080020106
M8	5/16	52	300	0,90	100	080020108
M10	3/8	60	470	1,44	100	080020110
M11	7/16	65	580	2,04	1	080020111
M12	1/2	72	690	2,55	50	080020112
M14	9/16	85	940	3,15	1	080020114
M16	5/8	95	1290	5,30	1	080020116
M18	11/16	103	1660	7,75	1	080020118
M20	3/4	110	2130	8,70	1	080020120
M22	7/8	120	2630	12,70	1	080020122
M24	1"	130	3060	16,10	1	080020124
M27	1 1/8	135	4000	22,20	1	080020127
M30	1 1/4	140	4860	26,00	1	080020130
M33	1 1/4	148	6040	31,50	1	080020133
M36	1 3/8	150	6500	38,00	1	080020198
M39	1 1/2	150	7900	44,50	1	080020199

filetto sinistrorso

Ø mm	≈ "	E mm	WFL kg	€		
M5	3/16	37	115	0,50	1	080020305
M6	1/4	40	160	0,61	1	080020306
M8	5/16	52	300	0,90	1	080020308
M10	3/8	60	470	1,44	1	080020310
M11	7/16	65	580	2,04	1	080020311
M12	1/2	72	690	2,55	1	080020312
M14	9/16	85	940	3,15	1	080020314
M16	5/8	95	1290	5,30	1	080020316
M18	11/16	103	1660	7,75	1	080020318
M20	3/4	110	2130	8,70	1	080020320
M22	7/8	120	2630	12,70	1	080020322
M24	1"	130	3060	16,10	1	080020324
M27	1 1/8	135	4000	22,20	1	080020327
M30	1 1/4	140	4860	26,00	1	080020330
M33	1 1/4	148	6040	31,50	1	080020333
M36	1 3/8	150	6500	38,00	1	080020398
M39	1 1/2	150	7900	44,50	1	080020399



8003ZD

ganci per tenditori,
filettatura destra, zincati



DATI TECNICI

• coefficiente di sicurezza: 4

ANALISI DI LABORATORIO

• analisi chimica

• test di trazione

CERTIFICATI DISPONIBILI

• Specifica Prodotto

• Rapporto di Prova tipo 2.2 UNI EN10204

Ø mm	≈ "	E mm	WFL kg	€		
M5	3/16	40	25	0,66	150	080030105
M6	1/4	40	45	0,75	120	080030106
M8	5/16	52	95	1,11	100	080030108
M10	3/8	60	140	1,98	70	080030110
M11	7/16	65	165	2,70	1	080030111
M12	1/2	70	300	3,45	30	080030112
M14	9/16	85	420	5,30	1	080030114
M16	5/8	95	570	7,90	1	080030116
M18	11/16	103	700	10,60	1	080030118
M20	3/4	110	900	14,40	1	080030120
M22	7/8	120	1100	18,70	1	080030122
M24	1"	130	1300	28,50	1	080030124
M27	1 1/8	135	2300	34,00	1	080030127

filetto sinistrorso

Ø mm	≈ "	WFL kg	E mm	€		
M5	3/16	40	25	0,66	1	080030305
M6	1/4	40	45	0,75	1	080030306
M8	5/16	52	95	1,11	1	080030308
M10	3/8	60	140	1,98	1	080030310
M11	7/16	65	165	2,70	1	080030311
M12	1/2	70	300	3,45	1	080030312
M14	9/16	85	420	5,30	1	080030314
M16	5/8	95	570	7,90	1	080030316
M18	11/16	103	700	10,60	1	080030318
M20	3/4	110	900	14,40	1	080030320
M22	7/8	120	1100	18,70	1	080030322
M24	1"	130	1300	28,50	1	080030324
M27	1 1/8	135	2300	34,00	1	080030327

8004ND

tronchi per tenditori
destrì - neri



DATI TECNICI

• coefficiente di sicurezza: 4

ANALISI DI LABORATORIO

• analisi chimica

• test di trazione

CERTIFICATI DISPONIBILI

• Specifica Prodotto

• Rapporto di Prova tipo 2.2 UNI EN10204

Ø mm	≈ "	E mm	WFL kg	€		
M5	3/16	40	115	0,52	1	080040005
M6	1/4	44	160	0,61	1	080040006
M8	5/16	53	300	0,72	1	080040008
M10	3/8	63	470	1,06	1	080040010
M12	1/2	70	690	1,77	1	080040012
M14	9/16	85	940	2,43	1	080040014
M16	5/8	95	1290	3,35	1	080040016
M18	11/16	103	1660	4,55	1	080040018
M20	3/4	110	2130	5,70	1	080040020
M22	7/8	120	2630	7,05	1	080040022
M24	1"	130	3060	10,00	1	080040024
M27	1 1/8	135	4000	16,00	1	080040027
M30	1 1/4	140	4860	19,80	1	080040030
M33	1 1/4	150	6040	20,40	1	080040033
M36	1 3/8	150	6500	27,00	1	080040098
M39	1 1/2	150	7900	29,00	1	080040099

filetto sinistrorso

Ø mm	≈ "	E mm	WFL kg	€		
M5	3/16	40	115	0,52	1	080040105
M6	1/4	44	160	0,61	1	080040106
M8	5/16	53	300	0,72	1	080040108
M10	3/8	63	470	1,06	1	080040110
M12	1/2	70	690	1,77	1	080040112
M14	9/16	85	940	2,43	1	080040114
M16	5/8	95	1290	3,35	1	080040116
M18	11/16	103	1660	4,55	1	080040118
M20	3/4	110	2130	5,70	1	080040120
M22	7/8	120	2630	7,05	1	080040122
M24	1"	130	3060	10,00	1	080040124
M27	1 1/8	135	4000	16,00	1	080040127
M30	1 1/4	140	4860	19,80	1	080040130
M33	1 1/4	150	6040	20,40	1	080040133
M36	1 3/8	150	6500	27,00	1	080040198
M39	1 1/2	150	7900	29,00	1	080040199



8009FD

forcelle per tenditori
destre - zincate



DATI TECNICI

- coefficiente di sicurezza: 4
- ANALISI DI LABORATORIO
- analisi chimica
- test di trazione
- CERTIFICATI DISPONIBILI
- Specifica Prodotto
- Rapporto di Prova tipo 2.2 UNI EN10204

Ø	≈	E	WFL	€		
mm	"	mm	kg			
M8	5/16	53	300	5,60	1	080090208
M10	3/8	63	470	6,60	1	080090210
M12	1/2	70	690	8,90	1	080090212
M14	9/16	85	940	12,30	1	080090214
M16	5/8	95	1290	14,00	1	080090216
M18	11/16	103	1660	19,80	1	080090218
M20	3/4	110	2130	20,40	1	080090220
M22	7/8	120	2630	29,00	1	080090222
M24	1"	130	3060	33,50	1	080090224
M27	1 1/8	135	4000	52,50	1	080090227
M30	1 3/16	140	4860	68,00	1	080090230

filetto sinistrorso

Ø	≈	WFL	G	€		
mm	"	kg	mm			
M8	5/16	53	300	5,60	1	080090408
M10	3/8	63	470	6,60	1	080090410
M12	1/2	70	690	8,90	1	080090412
M14	9/16	85	940	12,30	1	080090414
M16	5/8	95	1290	14,00	1	080090416
M18	11/16	103	1660	19,80	1	080090418
M20	3/4	110	2130	20,40	1	080090420
M22	7/8	120	2630	29,00	1	080090422
M24	1"	130	3060	33,50	1	080090424
M27	1 1/8	135	4000	52,50	1	080090427
M30	1 3/16	140	4860	68,00	1	080090430

8048

tiranti ad occhio
destri
neri



UNI 6058

ØxL	WFL	F	E	€		
mm	kg	mm	mm			
M8x50	430	6	39	3,50	20	080480108
M8x65	430	6	54	3,75	20	080480109
M10x80	690	8	66	5,85	10	080480110
M10x100	690	8	86	5,85	10	080480210
M10x130	690	8	116	6,60	10	080480111
M12x70	1020	10	53	6,05	8	080480212
M12x95	1020	10	78	6,20	8	080480112
M12x125	1020	10	108	7,60	8	080480113
M14x110	1420	12	91	8,55	6	080480114
M16x100	1980	14	79	7,05	6	080480115
M16x130	1980	14	109	7,30	6	080480116
M18x150	2390	16	126	16,50	2	080480118
M20x160	3100	18	134	20,40	2	080480120
M22x180	3890	18	152	32,00	1	080480122
M24x200	4460	20	168	36,50	1	080480124
M24x220	4460	20	188	39,00	1	080480125
M27x220	5900	22	185	47,50	1	080480127

8302Z

viti ad occhio per tasselli
filettatura destra
zincate

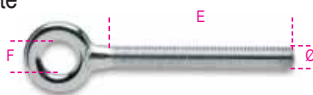

DATI TECNICI

- coefficiente di sicurezza: 4
- CERTIFICATI DISPONIBILI
- Specifica Prodotto
- Rapporto di Prova tipo 2.2 UNI EN10204

Ø	E	F	WFL	€		
mm	mm	mm	kg			
M5	48	8	115	0,56	200	083020005
M6	55	10	160	0,68	150	083020006
M8	60	12	300	0,92	100	083020008
M10	73	14	470	1,57	100	083020010
M12	90	17	690	3,05	50	083020012

confezioni speciali



Ø	E	€		
mm	mm			
M5	48	100	63,00	1 083020705
M6	55	75	57,50	1 083020706
M8	60	50	51,50	1 083020708
M10	73	50	88,50	1 083020710
M12	90	25	85,50	1 083020712

8303Z

ganci per tasselli
filettatura destra
zincati



DATI TECNICI

- coefficiente di sicurezza: 4
- CERTIFICATI DISPONIBILI
- Specifica Prodotto
- Rapporto di Prova tipo 2.2 UNI EN10204

Ø	C	E	WFL	€		
mm	mm	mm	kg			
M5	6,0	48	25	0,66	120	083030005
M6	8,0	55	45	0,72	100	083030006
M8	10,0	60	95	1,17	75	083030008
M10	12,5	73	140	1,98	50	083030010
M12	16,0	90	220	3,30	20	083030012

confezioni speciali



Ø	C	€		
mm	mm			
M5	6,0	60	44,50	1 083030705
M6	8,0	50	40,50	1 083030706
M8	10,0	30	39,50	1 083030708
M10	12,5	25	55,50	1 083030710
M12	16,0	10	37,00	1 083030712

8702N - 8702Z - 8702ZC

capicorda a pressare in acciaio forgiato
terminale ad occhio
neri



DATI TECNICI

- codice lotto di fabbricazione
- ANALISI DI LABORATORIO
- analisi chimica
- test di trazione
- CERTIFICATI DISPONIBILI
- Specifica Prodotto
- Certificato di Controllo tipo 3.1 UNI EN10204

M	Ø B	Ø A	Ø D	€		
	mm	mm	mm			
6	6,8	13	19	47,50	1	087020106
8	8,8	20	22	57,00	1	087020108
9	9,8	20	22	57,00	1	087020109
10	10,8	20	22	57,00	1	087020110
11	11,8	25	27	70,50	1	087020111
12	12,8	25	27	70,50	1	087020112
13	13,8	25	27	70,50	1	087020113
14	14,8	32	32	98,00	1	087020114
15	15,9	32	32	98,00	1	087020115
16	17,0	32	32	98,00	1	087020116
18	19,0	39	37	127,00	1	087020118
19	20,0	39	37	127,00	1	087020119
20	21,1	39	37	127,00	1	087020120
22	23,2	43	43	176,50	1	087020122
24	25,4	50	52	203,50	1	087020124
25	26,4	50	52	203,50	1	087020125
26	27,4	50	52	203,50	1	087020126

La pressatura dei capicorda richiede presse e stampi idonei e può essere eseguita esclusivamente da personale specializzato.

8702Z zincati

M	Ø B	Ø A	Ø D	€		
	mm	mm	mm			
6	6,8	13	19	49,50	1	087020306
8	8,8	20	22	60,00	1	087020308
9	9,8	20	22	60,00	1	087020309
10	10,8	20	22	60,00	1	087020310
11	11,8	25	27	73,50	1	087020311
12	12,8	25	27	73,50	1	087020312
13	13,8	25	27	73,50	1	087020313
14	14,8	32	32	103,00	1	087020314
15	15,9	32	32	103,00	1	087020315
16	17,0	32	32	103,00	1	087020316
18	19,0	39	37	133,00	1	087020318
19	20,0	39	37	133,00	1	087020319
20	21,1	39	37	133,00	1	087020320
22	23,2	43	43	182,50	1	087020322
24	25,4	50	52	212,50	1	087020324
25	26,4	50	52	212,50	1	087020325
26	27,4	50	52	212,50	1	087020326

8702ZC zincati a caldo

M	Ø B	Ø A	Ø D	€		
	mm	mm	mm			
6	6,8	13	19	52,50	1	087020206
8	8,8	20	22	65,00	1	087020208
9	9,8	20	22	65,00	1	087020209
10	10,8	20	22	65,00	1	087020210
11	11,8	25	27	80,50	1	087020211
12	12,8	25	27	80,50	1	087020212
13	13,8	25	27	80,50	1	087020213
14	14,8	32	32	119,00	1	087020214
15	15,9	32	32	119,00	1	087020215
16	17,0	32	32	119,00	1	087020216
18	19,0	39	37	153,50	1	087020218
19	20,0	39	37	153,50	1	087020219
20	21,1	39	37	153,50	1	087020220
22	23,2	43	43	208,50	1	087020222
24	25,4	50	52	243,50	1	087020224
25	26,4	50	52	243,50	1	087020225
26	27,4	50	52	243,50	1	087020226

8709N - 8709Z - 8709ZC

capicorda a pressare in acciaio forgiato
terminale a forcella
neri



DATI TECNICI

• codice lotto di fabbricazione

ANALISI DI LABORATORIO

• analisi chimica

• test di trazione

CERTIFICATI DISPONIBILI

• Specifica Prodotto

• Certificato di Controllo tipo 3.1 UNI EN10204

M	ØB mm	ØA mm	ØC mm	€	📦	🖨️
6	6,8	13	17	65,00	1	087090106
8	8,8	20	21	84,00	1	087090108
9	9,8	20	21	84,00	1	087090109
10	10,8	20	21	84,00	1	087090110
11	11,8	25	25	105,00	1	087090111
12	12,8	25	25	105,00	1	087090112
13	13,8	25	25	105,00	1	087090113
14	14,8	32	30	146,50	1	087090114
15	15,9	32	30	146,50	1	087090115
16	17,0	32	30	146,50	1	087090116
18	19,0	39	35	190,00	1	087090118
19	20,0	39	35	190,00	1	087090119
20	21,1	39	35	190,00	1	087090120
22	23,2	43	41	242,50	1	087090122
24	25,4	50	51	249,50	1	087090124
25	26,4	50	51	249,50	1	087090125
26	27,4	50	51	249,50	1	087090126

La pressatura dei capicorda richiede presse e stampi idonei e può essere eseguita esclusivamente da personale specializzato.

8709Z zincati

M	ØB mm	ØA mm	ØC mm	€	📦	🖨️
6	6,8	13	17	67,00	1	087090306
8	8,8	20	21	88,00	1	087090308
9	9,8	20	21	88,00	1	087090309
10	10,8	20	21	88,00	1	087090310
11	11,8	25	25	109,50	1	087090311
12	12,8	25	25	109,50	1	087090312
13	13,8	25	25	109,50	1	087090313
14	14,8	32	30	153,50	1	087090314
15	15,9	32	30	153,50	1	087090315
16	17,0	32	30	153,50	1	087090316
18	19,0	39	35	199,00	1	087090318
19	20,0	39	35	199,00	1	087090319
20	21,0	39	35	199,00	1	087090320
22	23,2	43	41	261,00	1	087090322
24	25,4	50	51	261,00	1	087090324
25	26,4	50	51	261,00	1	087090325
26	27,4	50	51	261,00	1	087090326

8709ZC zincati a caldo

M	ØB mm	ØA mm	ØC mm	€	📦	🖨️
6	6,8	13	17	69,50	1	087090206
8	8,8	20	21	92,50	1	087090208
9	9,8	20	21	92,50	1	087090209
10	10,8	20	21	92,50	1	087090210
11	11,8	25	25	119,50	1	087090211
12	12,8	25	25	119,50	1	087090212
13	13,8	25	25	119,50	1	087090213
14	14,8	32	30	173,50	1	087090214
15	15,9	32	30	173,50	1	087090215
16	17,0	32	30	173,50	1	087090216
18	19,0	39	35	221,00	1	087090218
19	20,0	39	35	221,00	1	087090219
20	21,1	39	35	221,00	1	087090220
22	23,2	43	41	282,00	1	087090222
24	25,4	50	51	310,00	1	087090224
25	26,4	50	51	310,00	1	087090225
26	27,4	50	51	310,00	1	087090226

MORSETTI



I morsetti professionali consentono la formazione di asole di funi metalliche a trefoli con anima in acciaio, da impiegare per l'ancoraggio e il tensionamento. A differenza di molti prodotti presenti sul mercato, il nostro morsetto 8016 NON ha un corpo in ghisa.

Infatti, al fine di garantire le migliori prestazioni meccaniche anche in impieghi gravosi, la base è forgiata a caldo ed ha un peso mediamente superiore a quello di articoli simili.

La zincatura elettrolitica di qualità, priva di cromo esavalente, garantisce una buona resistenza alla corrosione e ne impreziosisce l'estetica.

Nel corso di decenni di storia aziendale, tutte queste caratteristiche distintive hanno reso l'articolo 8016 l'icona del marchio **Robur** e contraddistinguono, nel mondo, il morsetto "tipo italiano".

8015

morsetti tipo pesante
corpo in acciaio
zincati a caldo

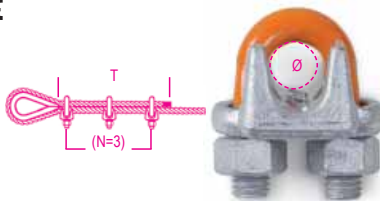

dimensioni EN 13411-5 tipo B

Dati tecnici

• Codice di identificazione

Analisi di laboratorio

• Analisi chimica

• Test coppia di serraggio

Certificati disponibili

• Specifica Prodotto

• Rapporto di Prova tipo 2.2 UNI EN10204

• Certificato del Fabbricante UNI EN13411-5

• Dichiarazione di Conformità CE

Ø mm	Ø "	NxT	Nm	€	📦	🖨️
8	5/16	3x133	40,7	2,37	12	080150808
10	3/8	3x165	61	3,30	12	080150810
13	1/2	3x292	88	5,10	6	080150813
16	5/8	3x305	129	7,20	6	080150816
20	3/4	4x460	176	9,90	6	080150820
22	7/8	4x480	305	15,70	6	080150822
26	1	5x660	305	17,10	5	080150826
30	1-1/8	6x860	305	18,30	2	080150830

8016

morsetti in acciaio
zincati

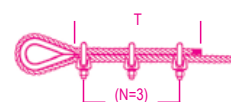

Caratteristiche tecniche:

• Cavallotto in acciaio classe di resistenza 4.6

• Corpo in acciaio S235JR

• Dado in acciaio classe di resistenza 6

• Trattamento superficiale: zincatura elettrolitica A2E EN ISO 4042 senza cromo esavalente

Certificati disponibili:

• Specifica Prodotto

• Rapporto di Prova tipo 2.2 UNI EN10204

• Certificato di Conformità CE

Ø mm	Ø "	NxT	Nm	€	📦	🖨️
3	1/8	3x80	1,53	0,64	500	080160003
5	3/16	3x110	3,02	0,81	300	080160005
6	1/4	3x120	5,19	0,90	200	080160006
8	5/16	5x210	5,19	1,11	150	080160008
10	3/8	5x240	12,54	1,67	70	080160010
11	7/16	5x260	12,54	1,80	70	080160011
12-13	1/2	5x300	24,76	2,41	40	080160013
14	9/16	5x295	24,76	2,62	35	080160014
16	5/8	5x335	24,76	3,10	30	080160016
18	11/16	5x380	42,42	4,20	30	080160018
20	3/4	5x540	42,42	4,55	30	080160020
22	7/8	7x595	42,42	5,30	25	080160022
24-26	1"	7x700	67,56	7,30	15	080160026
28	1"1/16	8x840	67,56	9,10	5	080160028
30-32	1"1/8	8x990	67,56	9,15	5	080160030
34-36	1"1/4	8x1155	105,80	12,10	4	080160034
38-40	1"1/2	8x1320	105,80	16,30	2	080160040
45-50	2"	8x1500	206	25,00	1	080160050

confezioni speciali



Ø mm	Ø "	NxT	Nm	€	📦	🖨️
3	1/8	100		72,00	1	080160703
5	3/16	50		45,50	1	080160705
6	1/4	50		50,50	1	080160706
8	5/16	30		37,50	1	080160708
10	3/8	30		56,50	1	080160710
11	7/16	25		50,50	1	080160711
12-13	1/2	15		40,50	1	080160713

confezioni appendibili



Ø mm	📦	€	🖨️
3	6	4,80	1 080169403
5	4	4,25	1 080169405
6	4	4,75	1 080169406
8	4	5,50	1 080169408
10	2	4,40	1 080169410
11	1	3,20	1 080169011
12-13	1	3,75	1 080169013
14	1	3,95	1 080169014
16	1	4,40	1 080169016
18	1	5,60	1 080169018
20	1	5,70	1 080169020
22	1	6,70	1 080169022
24-26	1	8,80	1 080169026

8016FR

morsetti in acciaio,
corpo stampato a freddo
zincati

CE

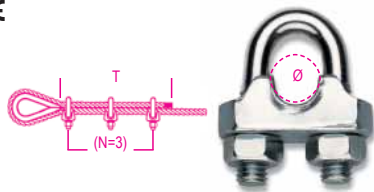

ANALISI DI LABORATORIO

- analisi chimica
- CERTIFICATI DISPONIBILI
- Specifica Prodotto
- Rapporto di Prova tipo 2.2 UNI EN10204
- Certificato di Conformità CE

Ø mm	Ø mm	N x T	Nm	€		
3	1/8	3x80	1,25	0,59	500	080160253
5	3/16	3x110	2,46	0,70	300	080160255
6	1/4	3x120	4,24	0,85	200	080160256
8	5/16	5x210	4,24	0,99	150	080160258

8018E

morsetti tipo ENEL, dado alto
corpo in acciaio zincato a caldo
cavallotti e dadi zincati e sigillati



ANALISI DI LABORATORIO

- analisi chimica
- CERTIFICATI DISPONIBILI
- Specifica Prodotto
- Rapporto di Prova tipo 2.2 UNI EN10204

Ø mm	A mm	L mm	Nm	€		
4÷6	M6	34	4,24	1,29	100	080180001

Robur

8016U2

morsetti
corpo in ghisa malleabile
zincati

CE

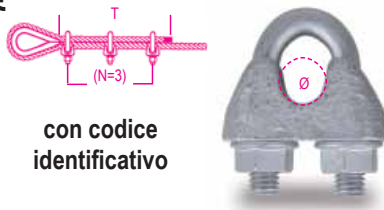

con codice
identificativo

dimensioni EN 13411-5 tipo A

DATI TECNICI

- codice di identificazione
- ANALISI DI LABORATORIO
- analisi chimica
- test coppia di serraggio
- CERTIFICATI DISPONIBILI
- Specifica Prodotto
- Rapporto di Prova tipo 2.2 UNI EN10204
- Certificato del Fabbricante UNI EN13411-5
- Dichiarazione di Conformità CE

Ø mm	Ø mm	N x T	Nm	€		
5	3/16	3x156	2,0	0,35	300	080160855
6,5	1/4	3x192	3,5	0,47	150	080160856
8	5/16	4x320	6	0,96	70	080160858
10	3/8	4x320	9	1,00	60	080160860
12	1/2	4x384	20	1,90	25	080160862
14	9/16	4x448	33	2,96	15	080160864
16	5/8	4x512	49	4,40	10	080160866
19	3/4	4x512	68	5,10	10	080160869
22	7/8	5x680	107	7,30	10	080160872
26	1	5x760	147	13,20	5	080160876
30	1.1/8	6x984	212	16,90	5	080160880
34	1.1/4	6x1080	296	23,20	5	080160884
40	1.1/2	6x1176	363	28,50	5	080160890

confezioni appendibili

Ø mm		€		
5	4	4,20	1	080169805
6	4	5,30	1	080169806
8	4	8,15	1	080169808
10	2	5,50	1	080169810
12	1	5,30	1	080169612
14	1	6,05	1	080169614
16	1	8,15	1	080169616
19	1	8,90	1	080169619
22	1	11,60	1	080169622
26	1	19,00	1	080169626

8016UGK

morsetti
in ghisa malleabile
corpo ZINCATO A CALDO
cavalotto e dadi GEOMET-GEOKOTE

CE



- elevata resistenza
alla corrosione
- codice
identificativo

dimensioni EN 13411-5 tipo A

DATI TECNICI

- codice di identificazione
- ANALISI DI LABORATORIO
- analisi chimica
- test coppia di serraggio
- CERTIFICATI DISPONIBILI
- Specifica Prodotto
- Rapporto di Prova tipo 2.2 UNI EN10204
- Certificato del Fabbricante UNI EN13411-5
- Dichiarazione di Conformità CE

Ø mm	Ø mm	N x T	Nm	€		
8	5/16	4x320	6	1,90	70	080160758
10	3/8	4x320	9	2,10	60	080160760
12	1/2	4x448	33	3,75	25	080160762
14	9/16	4x384	20	5,50	15	080160764
16	5/8	4x512	49	8,15	10	080160766
19	3/4	4x512	68	9,15	10	080160769
22	7/8	5x680	107	13,20	10	080160772
26	1	5x760	147	21,60	5	080160776
30	1,1/8	6x984	212	26,00	1	080160780
34	1,1/4	6x1080	296	37,00	1	080160784
40	1,1/2	6x1176	363	46,00	1	080160790

8018T

morsetti tipo TELECOM,
corpo in ghisa malleabile
zincato a caldo



RUM-MU-21:1980

ANALISI DI LABORATORIO

- analisi chimica
- CERTIFICATI DISPONIBILI
- Specifica Prodotto
- Rapporto di Prova tipo 2.2 UNI EN10204

Ø mm	A mm	L mm	Nm	€		
8÷10	M8	42	10,20	1,32	200	080180003

Robur

Robur

8020A

radance tipo leggero
zincate

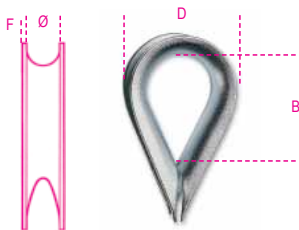

CERTIFICATI DISPONIBILI

- Specifica Prodotto
- Rapporto di Prova tipo 2.2 UNI EN10204

Ø mm	F mm	B mm	D mm	€		
2-3	1,0	20	18	0,24	150	080200503
4	1,2	23	19	0,25	150	080200504
5	1,2	24	23	0,29	100	080200505
6	1,2	27	28	0,30	100	080200506
8	1,4	33	32	0,47	50	080200508
10	1,8	41	38	0,69	30	080200510
12	2,2	44	45	0,91	30	080200512
14	2,2	52	49	1,17	50	080200514
16	3,0	58	58	1,64	50	080200516
18	3,7	64	68	2,31	50	080200518
20	3,7	73	74	2,99	35	080200520
22	3,7	83	79	3,35	30	080200522
24	3,7	93	88	4,40	20	080200525

confezioni speciali



Ø mm	S mm	€		
2-3	0,8	36,00	1	080200703
4	1,0	37,50	1	080200704
5	1,0	29,00	1	080200705
6	1,0	30,00	1	080200706
8	1,2	23,50	1	080200708
10	1,5	20,70	1	080200710

8021A

radance tipo pesante
per funi in acciaio
zincate

rispetto alla versione leggera, il maggior spessore della lamiera garantisce una superiore resistenza alla deformazione e consente di sfruttare al meglio le proprietà meccaniche delle funi di acciaio.

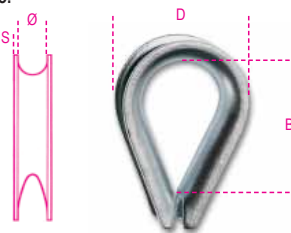

CERTIFICATI DISPONIBILI

- Specifica Prodotto
- Rapporto di Prova tipo 2.2 UNI EN10204

Ø mm	S mm	B mm	D mm	€		
2-3	0,6	15	16	0,39	150	080210103
5	1,7	29	28	0,56	120	080210105
6	1,8	33	30	0,62	100	080210106
8	2,5	36	37	0,84	100	080210108
10	2,5	42	43	1,02	80	080210110
12	2,5	48	50	1,32	100	080210112
14	2,7	58	57	1,77	70	080210114
16	3	61	62	2,16	50	080210116
18	3,5	71	71	2,82	70	080210118
20	4	79	79	4,20	30	080210120
22	4	87	84	4,85	25	080210122
24	4	93	92	5,70	25	080210124
26	4	103	103	7,05	20	080210126
28	5	107	116	16,50	1	080210128
30	5	118	121	16,50	1	080210130
32	5,5	138	135	19,80	1	080210132
35	6	140	147	27,50	1	080210135
40	6,0	174	170	39,00	1	080210140

GRILLI



I grilli **Robur** ad alta resistenza, a differenza di prodotti analoghi, sono interamente realizzati in acciaio legato al Cromo Molibdeno, bonificato, e sono progettati per superare 20.000 cicli a pieno carico nei test di laboratorio. Per queste ragioni si collocano ai vertici della propria categoria e possono essere la migliore opzione per impieghi gravosi, avendo un coefficiente di sicurezza superiore alla norma di riferimento (6:1 anziché 5:1) e un'ottima resilienza anche a basse temperature.

I grilli **Robur** in acciaio dolce sono garanzia di affidabilità ed efficacia nel tempo, grazie alla qualità della materia prima, alla cura delle lavorazioni meccaniche e al trattamento termico di normalizzazione, che permettono di raggiungere un carico di lavoro e un fattore di sicurezza superiori a quelli di prodotti simili sul mercato. La marcatura chiara e indelebile su ogni pezzo consente di identificare l'origine del grillo anche nel caso di ispezione da parte di società di verifica o di Enti competenti.

8026R

grilli diritti per sollevamento, perno a vite,
acciaio legato ad alta resistenza, Grado 6
staffa zincata a caldo

CE

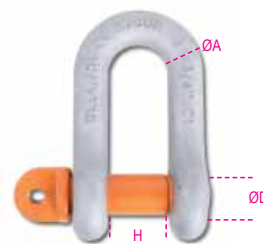

EN 13889

DATI TECNICI

- coefficiente di sicurezza minimo: 6
- trattamento termico: bonifica
- codice lotto fabbricazione su perno e staffa
- ANALISI DI LABORATORIO
- analisi chimica • analisi metallografica
- test di trazione • test di fatica (min.20.000 cicli)
- test carico di collaudo (2 x wll)

CERTIFICATI DISPONIBILI

- Specifica Prodotto • Rapporto di Prova tipo 2.2 UNI EN10204
- Certificato di Controllo tipo 3.1 UNI EN10204
- Dichiarazione di Conformità CE

ØD mm	ØA mm	H mm	WLL kg	€		
11	10	17	1000	6,40	5	080260210
16	13	21	2000	11,90	5	080260212
19	16	27	3250	20,10	3	080260216
22	19	32	4750	29,00	2	080260219
25	22	37	6500	44,50	2	080260222

confezioni appendibili



ØD mm	€		
16	13,00	1	080269212
19	21,60	1	080269216

8029R

grilli per sollevamento a lira, perno a vite
acciaio legato ad alta resistenza, Grado 6
staffa zincata a caldo

CE

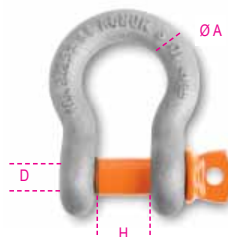

EN 13889

DATI TECNICI

- coefficiente di sicurezza minimo: 6
- trattamento termico: bonifica
- codice lotto fabbricazione su perno e staffa
- ANALISI DI LABORATORIO

ANALISI DI LABORATORIO

- analisi chimica
- analisi metallografica
- test di trazione
- test di fatica (min.20.000 cicli)
- test carico di collaudo (2 x wll)

CERTIFICATI DISPONIBILI

- Specifica Prodotto
- Rapporto di Prova tipo 2.2 UNI EN10204
- Certificato di Controllo tipo 3.1 UNI EN10204
- Dichiarazione di Conformità CE

ØD mm	ØA mm	H mm	WLL kg	€		
8	6	13	500	3,90	20	080290106
10	8	13,5	750	4,75	15	080290108
11	10	17	1000	6,70	15	080290110
13	11	18,5	1500	8,90	10	080290111
16	13	20,5	2000	9,15	8	080290112
19	16	27	3250	15,70	8	080290116
22	19	32	4750	23,10	4	080290120
25	22	37	6500	34,50	4	080290122
28	26	43,5	8500	47,50	1	080290124

ØD mm	ØA mm	H mm	WLL kg	€	📦	🚚
32	29	48	9500	88,50	1	080290128
35	32	53	12000	118,50	1	080290132
38	35	59	13500	155,50	1	080290135
42	38	62	17000	203,50	1	080290138
50	45	75	25000	348,00	1	080290145
57	50	83	35000	609,00	1	080290150
65	57	95	42500	1.049,00	1	080290157
70	65	105	55000	1.200,00	1	080290165

confezioni appendibili



ØD mm	📦	€	📦	🚚
8	1	5,30	1	080299106
10	1	6,05	1	080299108
11	1	8,15	1	080299110
13	1	10,30	1	080299111
16	1	10,50	1	080299112
19	1	17,70	1	080299116

confezioni speciali



ØD mm	ØA mm	📦	€	📦	🚚
8	6	10	44,00	1	080290706
10	8	10	53,50	1	080290708
11	10	10	75,50	1	080290710
13	11	5	50,00	1	080290711
16	13	4	41,00	1	080290712
19	16	4	70,50	1	080290716
22	19	2	52,00	1	080290720
25	22	2	77,50	1	080290722

8031R

grilli per sollevamento a lira con dado e copiglia
acciaio legato ad alta resistenza, Grado 6
staffa zincata a caldo

CE



EN 13889

DATI TECNICI

- coefficiente di sicurezza minimo: 6
 - trattamento termico: bonifica
 - codice lotto fabbricazione su perno e staffa
- ANALISI DI LABORATORIO**
- analisi chimica • analisi metallografica
 - test di trazione
 - test di fatica (min.20.000 cicli)
 - test carico di collaudo (2 x wll)
- CERTIFICATI DISPONIBILI**
- Specifica Prodotto
 - Rapporto di Prova tipo 2.2 UNI EN10204
 - Certificato di Controllo tipo 3.1 UNI EN10204
 - Dichiarazione di Conformità CE

ØD mm	ØA mm	H mm	WLL kg	€	📦	🚚
11	10	17	1000	7,20	5	080310110
13	11	18	1500	11,10	5	080310111
16	13	21	2000	11,30	5	080310112
19	16	27	3250	19,40	3	080310116
22	19	32	4750	27,50	2	080310120
25	22	37	6500	38,00	2	080310122
28	26	43	8500	56,50	1	080310124

ØA mm	ØD mm	H mm	WLL kg	€	📦	🚚
29	32	48	9500	97,00	1	080310128
32	35	53	12000	125,50	1	080310132
35	38	59	13500	176,50	1	080310135
38	42	62	17000	215,50	1	080310138
45	50	75	25000	377,00	1	080310145
50	57	83	35000	662,00	1	080310150
65	70	105	55000	1.355,00	1	080310165
75	83	127	85000	2.055,00	1	080310183

confezioni appendibili



ØD mm	📦	€	📦	🚚
16	1	14,00	1	080319112
19	1	23,70	1	080319116

8032

grilli a lira per sollevamento, perno a foro quadro
acciaio legato ad alta resistenza, Grado 6
staffa zincata a caldo

CE



DATI TECNICI

- coefficiente di sicurezza minimo: 6
 - trattamento termico: bonifica
 - codice lotto fabbricazione su perno e staffa
- ANALISI DI LABORATORIO**
- analisi chimica
 - analisi metallografica
 - test di trazione
 - test di fatica (min.20.000 cicli)
 - test carico di collaudo (2 x wll)
- CERTIFICATI DISPONIBILI**
- Specifica Prodotto
 - Rapporto di Prova tipo 2.2 UNI EN10204
 - Certificato di Controllo tipo 3.1 UNI EN10204
 - Dichiarazione di Conformità CE

ØD mm	ØA mm	H mm	WLL kg	€	📦	🚚
11	10	17	1000	8,55	5	080320010
16	13	21	2000	10,80	5	080320012
19	16	27	3250	19,70	3	080320016
22	19	32	4750	34,00	2	080320020
25	22	37	6500	49,50	2	080320022

confezioni appendibili



ØD mm	📦	€	📦	🚚
16	1	13,00	1	080329012
19	1	21,60	1	080329016



8025

grilli per sollevamento dritti, tipo largo
acciaio al carbonio, Grado 4
zincati

CE

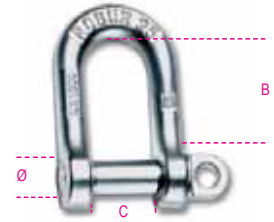

DATI TECNICI

- coefficiente di sicurezza: 5
- trattamento termico: normalizzazione
- codice lotto di fabbricazione

ANALISI DI LABORATORIO

- analisi chimica
- analisi metallografica
- test di trazione

CERTIFICATI DISPONIBILI

- Specifica Prodotto
- Rapporto di Prova tipo 2.2 UNI EN10204
- Certificato di Controllo tipo 3.1 UNI EN10204
- Dichiarazione di Conformità CE

Ø mm	≈ "	B x C mm	WLL kg	€	📦	🚚
5	3/16	21x10	70	1,51	250	080250005
6	1/4	25x12	100	2,04	250	080250006
8	5/16	33x16	250	3,40	150	080250008
10	3/8	42x20	400	3,75	180	080250010
11	7/16	46x22	500	4,60	130	080250011
12	1/2	50x24	600	4,95	100	080250012
14	9/16	57x28	800	6,45	70	080250014
16	5/8	61x32	1000	8,40	10	080250016
18	11/16	65x36	1300	12,20	10	080250018
20	3/4	70x40	1600	14,30	10	080250020
22	7/8	74x44	2000	19,80	10	080250022
25	1"	80x48	2800	26,50	2	080250025

confezioni speciali



Ø mm	≈ "	📦	€	📦	🚚
5	3/16	25	42,50	1	080250705
6	1/4	25	57,50	1	080250706
8	5/16	25	95,50	1	080250708
10	3/8	15	63,00	1	080250710
11	7/16	12	62,00	1	080250711
12	1/2	12	67,00	1	080250712
14	9/16	10	72,50	1	080250714

confezioni appendibili



Ø mm	📦	€	📦	🚚
5	4	7,60	1	080259205
6	4	9,70	1	080259206
8	2	8,10	1	080259208
10	2	8,70	1	080259210
11	1	5,70	1	080259011
12	1	6,20	1	080259012
14	1	7,60	1	080259014
16	1	9,55	1	080259016
18	1	14,30	1	080259018
20	1	16,10	1	080259020
22	1	21,00	1	080259022
25	1	27,50	1	080259025

8026A

grilli per sollevamento dritti, tipo UNI
acciaio al carbonio, Grado 4
zincati

CE

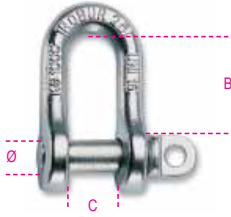

DATI TECNICI

- coefficiente di sicurezza: 5
- trattamento termico: normalizzazione
- codice lotto di fabbricazione

ANALISI DI LABORATORIO

- analisi chimica
- analisi metallografica
- test di trazione

CERTIFICATI DISPONIBILI

- Specifica Prodotto
- Rapporto di Prova tipo 2.2 UNI EN10204
- Certificato di Controllo tipo 3.1 UNI EN10204
- Dichiarazione di Conformità CE

Ø mm	≈ "	B x C mm	WLL kg	€	📦	🚚
12	1/2	42x20	630	4,75	35	080260012
14	9/16	46x22	800	5,90	30	080260014
16	5/8	50x24	1000	7,60	20	080260016
18	11/16	54x26	1300	10,70	15	080260018
20	3/4	58x28	1600	13,50	10	080260020
22	7/8	69x32	2000	17,70	10	080260022
25	1"	79x36	2500	25,00	5	080260025
28	1.1/8	90x40	3150	34,50	2	080260028
32	1.1/4	100x45	4000	47,50	1	080260032
36	1.3/8	110x50	5000	68,00	1	080260036
40	1.9/16	120x55	6300	94,00	1	080260040
42	1.5/8	131x60	8000	128,50	1	080260042
45	1.3/4	143x65	10000	175,50	1	080260045
50	2"	155x70	12500	218,00	1	080260050

confezioni appendibili



Ø mm	📦	€	📦	🚚
12	1	6,10	1	080269012
14	1	7,30	1	080269014
16	1	8,55	1	080269016
18	1	13,00	1	080269018
20	1	15,50	1	080269020
22	1	19,80	1	080269022
25	1	27,50	1	080269025



8028

grilli per sollevamento a lira
acciaio al carbonio, Grado 4
zincati

CE

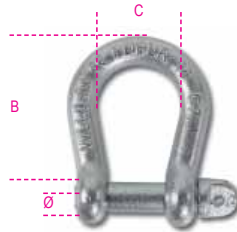

DATI TECNICI

- coefficiente di sicurezza: 5
- trattamento termico: normalizzazione
- codice lotto di fabbricazione

ANALISI DI LABORATORIO

- analisi chimica
- analisi metallografica
- test di trazione

CERTIFICATI DISPONIBILI

- Specifica Prodotto
- Rapporto di Prova tipo 2.2 UNI EN10204
- Certificato di Controllo tipo 3.1 UNI EN10204
- Dichiarazione di Conformità CE

Ø mm	≈ "	B x C mm	WLL kg	€	📦	🚚
5	3/16	20x16	80	1,30	100	080280105
6	1/4	24x20	100	1,94	70	080280106
8	5/16	32x24	200	3,35	35	080280108
10	3/8	40x33	300	3,85	25	080280110
12	1/2	48x39	500	6,10	15	080280112
14	9/16	56x46	600	8,70	7	080280114
16	5/8	64x46	800	13,10	10	080280116
18	11/16	71x59	950	16,10	5	080280118
20	3/4	80x65	1100	23,10	5	080280120
22	7/8	88x72	1500	29,00	5	080280122
25	1"	100x81	2000	44,50	2	080280125
28	1.1/8	112x91	2600	69,00	1	080280128
32	1.1/4	128x104	3200	94,50	1	080280132
38	1.1/2	152x124	4500	188,00	1	080280138

confezioni appendibili



Ø mm	📦	€	📦	🚚
5	4	6,45	1	080289305
6	4	9,30	1	080289306
8	2	8,35	1	080289308
10	2	9,00	1	080289310
12	1	7,45	1	080289112
14	1	10,00	1	080289114
16	1	14,20	1	080289116
18	1	18,00	1	080289118
20	1	24,90	1	080289120
22	1	32,00	1	080289122

8049 WLL (t)

	A°	M8	M10	M12	M16	M20	M24	M30
	0°	0,3	0,6	1	1,6	2,5	4	6,3
	0°	0,6	1,2	2	3,2	5	8	12,6
	90°	0,3	0,6	1	1,6	2,5	4	6,3
	90°	0,6	1,2	2	3,2	5	8	12,6
	0°	0,4	0,8	1,4	2,2	3,5	5,6	8,8
	45°	0,3	0,6	1	1,6	2,5	4	6,3
	60°	0,3	0,6	1	1,6	2,5	4	6,3
	0°	0,6	1,3	2,1	3,4	5,3	8,4	13,2
	45°	0,3	0,6	1	1,6	2,3	4	6,3
	60°	0,3	0,6	1	1,6	2,3	4	6,3

8049

golfari maschio per sollevamento,
orientabili a doppia articolazione,
acciaio legato ad alta resistenza

CE

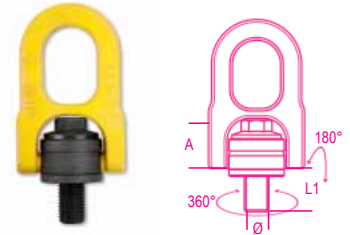

DATI TECNICI

- coefficiente di sicurezza: 5
- trattamento termico: bonifica
- codice lotto fabbricazione

ANALISI DI LABORATORIO

- analisi chimica
- analisi metallografica
- test di trazione

CERTIFICATI DISPONIBILI

- Specifica Prodotto
- Rapporto di Prova tipo 2.2 UNI EN10204
- Certificato di Controllo tipo 3.1 UNI EN10204
- Dichiarazione di Conformità CE

Ø mm	A mm	L1 mm	WLL 90° kg	€	📦	🚚
M8	31,5	14	300	130,00	1	080490008
M10	31,5	17	600	135,50	1	080490010
M12	31,5	21	1000	139,00	1	080490012
M16	45	27	1600	160,00	1	080490016
M20	45	30	2500	164,00	1	080490020
M24	60,5	36	4000	281,00	1	080490024
M30	60,5	45	6300	293,00	1	080490030



8049A WLL (kg)										
	Ø"	M6	M8	M10	M12	M16	M20	M24	M30	M36
	0°	400	600	900	1000	2000	4000	6300	10000	11000
	0°	800	1200	1800	2000	4000	8000	12600	21200	23600
	90°	200	300	450	500	1120	2000	3150	5300	8000
	90°	400	600	900	1000	2000	4000	6300	10600	16000
	0°	250	400	600	700	1400	2800	4250	7100	10700
	45°	200	300	450	500	1120	2000	3150	5300	8000
	60°	200	300	450	500	1120	2000	3150	5300	8000
	0°	400	600	900	1000	2100	4200	6300	11200	16000
	45°	250	400	600	750	1500	3000	4750	8000	10700
	60°	250	400	600	750	1500	3000	4750	8000	10700

8049A

golfari maschio per sollevamento a doppia articolazione, girevole sotto carico con anello saldato in acciaio legato ad alta resistenza

Golfare girevole a 360° e staffa orientabile

CE



DATI TECNICI

- coefficiente di sicurezza: 4
 - trattamento termico: bonifica
 - codice lotto fabbricazione
- ANALISI DI LABORATORIO
- analisi chimica
 - analisi metallografica
 - test di trazione
 - test di fatica (20.000 cicli)
 - carico di collaudo (100% del lotto)

CERTIFICATI DISPONIBILI

- Specifica Prodotto
- Rapporto di Prova tipo 2.2 UNI EN10204
- Certificato di Controllo tipo 3.1 UNI EN10204
- Dichiarazione di Conformità CE

Ø	E	A	WLL 90°	€		
mm	mm	mm	kg			
M6	13	30	200	43,00	1	080490106
M8	13	30	300	44,00	1	080490108
M10	19	30	450	46,00	1	080490110
M12	19	30	500	49,00	1	080490112
M16	20	30	1120	52,00	1	080490116
M20	30	40	2000	75,00	1	080490120
M24	30	40	3150	110,00	1	080490124
M30	35	50	5300	190,00	1	080490130
M36	54	50	8000	200,00	1	080490136

Robur

8049V

golfari maschio per sollevamento con staffa disassata, acciaio legato ad alta resistenza

Golfare girevole a 360° e staffa orientabile

CE



Dati tecnici

- Coefficiente di sicurezza: 4
 - Trattamento termico: bonifica
 - Codice lotto fabbricazione
- Analisi di laboratorio
- Analisi chimica
 - Analisi metallografica
 - Test di trazione
 - Test di fatica (20.000 cicli)
 - Carico di collaudo (100% del lotto)

Certificati disponibili:

- Specifica Prodotto
- Rapporto di Prova tipo 2.2 UNI EN10204
- Certificato di Controllo tipo 3.1 UNI EN10204
- Dichiarazione di Conformità CE

Ø	E	B	WLL	€		
mm	mm	mm	kg			
M10	13,5	37	630	72,00	1	080490310
M12	18	37,5	1000	88,00	1	080490312
M16	24	37,5	1500	94,00	1	080490316
M20	35,5	54	2500	136,50	1	080490320
M24	35,5	54	4000	140,50	1	080490324

8068S

staffe a saldare per sollevamento a base singola con molla di posizionamento, corpo in acciaio legato ad alta resistenza

- Minimo ingombro per operazioni di sollevamento
- Dimensionate per 20.000 cicli di lavoro a pieno carico
- Carico di Collaudo applicato sul 100% dei pezzi prima della vendita
- Coefficiente di sicurezza 4 in tutte le direzioni

CE



DATI TECNICI

- Coefficiente di sicurezza: 4
 - Trattamento termico: bonifica
 - Codice lotto fabbricazione
- ANALISI DI LABORATORIO
- Analisi chimica
 - Analisi metallografica
 - Test di trazione
 - Test di fatica (20.000 cicli)
 - Carico di collaudo (100% del lotto)

CERTIFICATI DISPONIBILI

- Specifica Prodotto
- Rapporto di Prova tipo 2.2 UNI EN10204
- Certificato di Controllo tipo 3.1 UNI EN10204
- Dichiarazione di Conformità CE

WLL	B	M	A	€		
Kg	mm	mm	mm			
1500	78	37	41	10,60	1	080680115
2500	88	40	42	13,90	1	080680125
4000	94	42	45	19,90	1	080680140
6700	118	51	55	37,00	1	080680167

Attenzione:

- L'elemento di accoppiamento deve garantire un'adeguata resistenza meccanica e deve essere idoneo alla saldatura.
- La saldatura deve essere eseguita da personale competente, adeguatamente formato.

8041

golfari maschio per sollevamento, acciaio legato ad alta resistenza grado 8

CE



DATI TECNICI

- coefficiente di sicurezza: 4
 - trattamento termico: bonifica
 - codice lotto fabbricazione
- ANALISI DI LABORATORIO
- analisi chimica
 - analisi metallografica
 - test di trazione
 - test di fatica (20.000 cicli)
 - carico di collaudo (100% del lotto)

CERTIFICATI DISPONIBILI

- Specifica Prodotto
- Rapporto di Prova tipo 2.2 UNI EN10204
- Certificato di Controllo tipo 3.1 UNI EN10204
- Dichiarazione di Conformità CE

Ø	E	WLL	€			
mm	mm	kg				
M6	11	400	3,50	10	080410206	
* M8	1,25	13	800	3,50	10	080410208
* M10	1,5	17	1000	5,40	6	080410210
* M12	1,75	20,5	1600	8,15	4	080410212
M14	2	20,5	3000	13,50	2	080410214
M16	2,5	27	4000	20,40	2	080410217
M18	2,5	27	5000	20,40	2	080410218
M20	3,0	30	6000	38,00	2	080410221
M22	2,5	30	7000	38,00	2	080410222
M24	3	36	8000	46,00	2	080410225
M27	3	41	10000	70,00	1	080410227
* M30	3,5	45	12000	70,00	1	080410230

(* Caratteristiche meccaniche e materiali EN1677-1

confezioni appendibili



Ø	€		
mm			
* M8	5,60	1	080419208
* M10	7,85	1	080419210
* M12	10,80	1	080419212

Robur

8043

golfari femmina per sollevamento,
acciaio legato ad alta resistenza
grado 8

CE

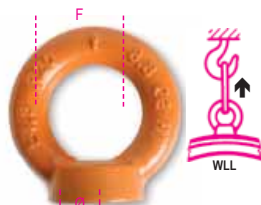

DATI TECNICI

- coefficiente di sicurezza: 4
 - trattamento termico: bonifica
 - codice lotto fabbricazione
- ANALISI DI LABORATORIO
- analisi chimica
 - analisi metallografica
 - test di trazione
 - test di fatica (20.000 cicli)
 - carico di collaudo (100% del lotto)

CERTIFICATI DISPONIBILI

- Specifica Prodotto
- Rapporto di Prova tipo 2.2 UNI EN10204
- Certificato di Controllo tipo 3.1 UNI EN10204
- Dichiarazione di Conformità CE

Ø	F	WLL	€	Icona	Icona
mm	mm	kg			
* M6	1	20	400	3,40	10 080430206
* M8	1,25	20	800	3,40	10 080430208
* M10	1,50	25	1000	5,30	6 080430210
* M12	1,75	30	1600	8,05	4 080430212
M14	2	35	3000	13,20	2 080430214
M16	2	40	4000	19,10	2 080430217
M18	2,5	40	5000	19,10	2 080430218
M20	2,5	50	6000	37,00	2 080430221
M22	2,5	50	7000	37,00	2 080430222
M24	3	55	8000	43,00	2 080430225
* M27	3	60	10000	67,00	1 080430227
* M30	3,5	60	12000	67,00	1 080430230

(* Caratteristiche meccaniche e materiali EN1677-1

confezioni appendibili

Ø	€	Icona	Icona
mm			
* M8	5,30	1	080439208
* M10	7,60	1	080439210
* M12	10,30	1	080439212

GOLFARI

I golfari **Robur**

in acciaio dolce al carbonio sono costruiti con l'aggiunta di una percentuale minima di alluminio e devono rispettare rigorosi parametri relativi alla dimensione dei grani del materiale, come richiesto dalle norme DIN580-582.

Anche la cura nelle lavorazioni meccaniche contribuisce a fare la differenza: la raggatura del collarino alla base del golfare facilita infatti l'aderenza e il pieno contatto con la superficie del corpo da sollevare. Queste qualità distintive rendono i nostri golfari adatti a sollevamenti complessi e a un utilizzo intensivo, come in ambienti in cui si opera a ciclo continuo o ad un range di temperatura compreso tra -20°C/+200°C.



8040EZ

golfari per sollevamento
maschio, zincati

CE

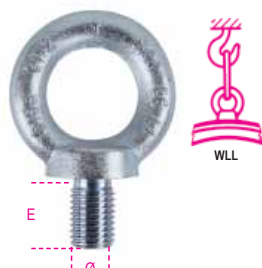

DIN 580:2018-04(**)

DATI TECNICI

- Coefficiente di sicurezza: 6
 - Trattamento termico: normalizzazione
 - Codice lotto di fabbricazione
- ANALISI DI LABORATORIO
- Analisi chimica
 - Analisi metallografica
 - Test di trazione

CERTIFICATI DISPONIBILI

- Specifica Prodotto
- Rapporto di Prova tipo 2.2 UNI EN10204
- Certificato di Controllo tipo 3.1 UNI EN10204
- Dichiarazione di Conformità CE

Ø	F	E	WLL	€	Icona	Icona
mm	mm	mm	kg			
* M6	1	11	90	1,90	60	080400406
M8	1,25	13	140	1,90	60	080400408
M10	1,5	17	230	2,55	40	080400410
M12	1,75	20,5	340	3,40	20	080400412
* M14	2	20,5	480	4,50	20	080400414
M16	2	27	700	5,60	10	080400416
* M18	2,5	27	930	6,80	10	080400418
M20	2,5	30	1200	8,70	10	080400420
* M22	2,5	30	1450	11,20	10	080400422
M24	3	36	1800	16,50	5	080400424
* M27	3	41	2400	20,40	5	080400427
M30	3,5	45	3200	34,00	2	080400430
* M33	3,5	54	3900	47,50	2	080400433
* M33F	2	54	3900	47,50	2	080400434
M36	4	54	4600	49,00	2	080400436
* M36F	3	54	4600	49,00	2	080400437
M42	4,5	63	6300	90,00	1	080400442
* M42F	3	63	6300	90,00	1	080400443
M48	5	68	8600	144,50	1	080400448
* M48F	3	68	8600	144,50	1	080400449
M56	5,5	78	11500	236,00	1	080400456
* M56F	4	78	11500	236,00	1	080400457
M64	6	90	16000	347,00	1	080400464
* M64F	4	90	16000	347,00	1	080400465

*Misure dimensionate secondo Fascicolo Tecnico Robur

**Caratteristiche meccaniche e materiali

confezioni speciali



Ø	F	€	Icona	Icona
mm	mm			
M6	1	20	42,50	1 080400906
M8	1,25	20	42,50	1 080400908
M10	1,5	20	57,50	1 080400910
M12	1,75	15	57,50	1 080400912

confezioni appendibili

Ø	€	Icona	Icona
mm			
M6	9,45	1	080409606
M8	9,45	1	080409608
M10	7,05	1	080409610
M12	4,85	1	080409412
* M14	5,70	1	080409414
M16	7,05	1	080409416
* M18	8,30	1	080409418
M20	10,00	1	080409420

Ø	€	Icona	Icona
mm			
* M22	13,20	1	080409422
M24	17,80	1	080409424
* M27	22,30	1	080409427
M30	35,00	1	080409430

8040EN

golfari per sollevamento
maschio, neri

CE



DIN 580:2018-04(**)

DATI TECNICI

- Coefficiente di sicurezza: 6
 - Trattamento termico: normalizzazione
 - Codice lotto di fabbricazione
- ANALISI DI LABORATORIO
- Analisi chimica
 - Analisi metallografica
 - Test di trazione

CERTIFICATI DISPONIBILI

- Specifica Prodotto
- Rapporto di Prova tipo 2.2 UNI EN10204
- Certificato di Controllo tipo 3.1 UNI EN10204
- Dichiarazione di Conformità CE

Ø	F	E	WLL	€	Icona	Icona
mm	mm	mm	kg			
* M6	1	11	90	1,83	60	080400306
M8	1,25	13	140	1,83	60	080400308
M10	1,5	17	230	2,49	40	080400310
M12	1,75	20,5	340	3,40	20	080400312
* M14	2	20,5	480	4,25	20	080400314
M16	2	27	700	5,30	10	080400316
* M18	2,5	27	930	6,60	10	080400318
M20	2,5	30	1200	8,15	10	080400320
* M22	2,5	30	1450	10,70	10	080400322
M24	3	36	1800	15,10	5	080400324
* M27	3	41	2400	19,00	5	080400327
M30	3,5	45	3200	32,00	2	080400330
* M33	3,5	54	3900	44,50	2	080400333
* M33F	2	54	3900	44,50	2	080400334
M36	4	54	4600	47,00	2	080400336
* M36F	3	54	4600	47,00	2	080400337
M42	4,5	63	6300	86,50	1	080400342
* M42F	3	63	6300	86,50	1	080400343
M48	5	68	8600	141,50	1	080400348
* M48F	3	68	8600	141,50	1	080400349
M56	5,5	78	11500	225,50	1	080400356
* M56F	4	78	11500	225,50	1	080400357
M64	6	90	16000	328,00	1	080400364
* M64F	4	90	16000	328,00	1	080400365

*Misure dimensionate secondo Fascicolo Tecnico Robur

**Caratteristiche meccaniche e materiali

confezioni appendibili

Ø	€	Icona	Icona
mm			
M6	8,90	1	080409506
M8	8,90	1	080409508
M10	6,50	1	080409510
M12	4,60	1	080409312
* M14	5,50	1	080409314
M16	6,50	1	080409316
* M18	7,75	1	080409318
M20	9,00	1	080409320
* M22	12,30	1	080409322
M24	16,50	1	080409324
* M27	20,40	1	080409327
M30	33,00	1	080409330

8042EZ

golfari per sollevamento
femmina, zincati

CE

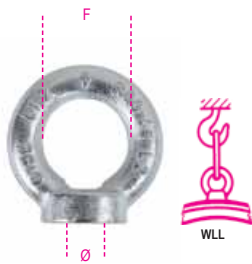

DIN582:2018-04(**)

DATI TECNICI

- Coefficiente di sicurezza: 6
- Trattamento termico: normalizzazione
- Codice lotto di fabbricazione

ANALISI DI LABORATORIO

- Analisi chimica
- Analisi metallografica
- Test di trazione

CERTIFICATI DISPONIBILI

- Specifica Prodotto
- Rapporto di Prova tipo 2.2 UNI EN10204
- Certificato di Controllo tipo 3.1 UNI EN10204
- Dichiarazione di Conformità CE

Ø mm	mm	F mm	WLL kg	€		
* M6	1	14	90	1,90	60	080420406
M8	1,25	20	140	1,90	60	080420408
M10	1,5	25	230	2,55	40	080420410
M12	1,75	30	340	3,50	30	080420412
* M14	2	30	480	4,50	30	080420414
M16	2	35	700	5,60	20	080420416
* M18	2,5	35	930	6,80	20	080420418
M20	2,5	40	1200	8,55	10	080420420
* M22	2,5	40	1450	11,10	10	080420422
M24	3	50	1800	16,50	5	080420424
* M27	3	55	2400	19,80	5	080420427
M30	3,5	60	3200	32,00	3	080420430
* M36	4	70	4600	48,50	2	080420436
* M36F	3	70	4600	48,50	2	080420437
M42	4,5	80	6300	88,00	1	080420442
* M42F	3	80	6300	88,00	1	080420443
M48	5	90	8600	142,50	1	080420448
* M48F	3	90	8600	142,50	1	080420449

*Misure dimensionate secondo Fascicolo Tecnico Robur

**Caratteristiche meccaniche e materiali

confezioni speciali



Ø mm	mm	F mm	WLL kg	€		
M6	1	20		41,00	1	080420906
M8	1,25	20		41,00	1	080420908
M10	1,5	20		56,00	1	080420910
M12	1,75	15		57,50	1	080420912

confezioni appendibili

Ø mm	mm	F mm	WLL kg	€		
M6	4			9,15	1	080429606
M8	4			9,15	1	080429608
M10	2			6,60	1	080429610
M12	1			4,85	1	080429412
* M14	1			5,50	1	080429414
M16	1			6,80	1	080429416
* M18	1			7,85	1	080429418
M20	1			9,70	1	080429420
* M22	1			12,30	1	080429422
M24	1			19,00	1	080429424
* M27	1			21,00	1	080429427
M30	1			32,50	1	080429430



8042EN

golfari per sollevamento
femmina, neri

CE

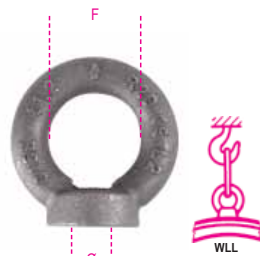

DIN582:2018-04(**)

DATI TECNICI

- Coefficiente di sicurezza: 6
- Trattamento termico: normalizzazione
- Codice lotto di fabbricazione

ANALISI DI LABORATORIO

- Analisi chimica
- Analisi metallografica
- Test di trazione

CERTIFICATI DISPONIBILI

- Specifica Prodotto
- Rapporto di Prova tipo 2.2 UNI EN10204
- Certificato di Controllo tipo 3.1 UNI EN10204
- Dichiarazione di Conformità CE

Ø mm	mm	F mm	WLL kg	€		
* M6	1	14	90	1,83	60	080420306
M8	1,25	20	140	1,83	60	080420308
M10	1,5	25	230	2,43	40	080420310
M12	1,75	30	340	3,40	30	080420312
* M14	2	30	480	4,35	30	080420314
M16	2	35	700	5,10	20	080420316
* M18	2,5	35	930	6,50	20	080420318
M20	2,5	40	1200	7,85	10	080420320
* M22	2,5	40	1450	10,50	10	080420322
M24	3	50	1800	15,10	5	080420324
* M27	3	55	2400	18,30	5	080420327
M30	3,5	60	3200	29,00	3	080420330
* M36	4	70	4600	44,50	2	080420336
* M36F	3	70	4600	44,50	2	080420337
* M42F	3	80	6300	82,50	1	080420342
M48	5	90	8600	135,50	1	080420348
* M48F	3	90	8600	135,50	1	080420349

*Misure dimensionate secondo Fascicolo Tecnico Robur

**Caratteristiche meccaniche e materiali

confezioni appendibili

Ø mm	mm	F mm	WLL kg	€		
M6	4			8,90	1	080429506
M8	4			8,90	1	080429508
M10	2			6,50	1	080429510
M12	1			4,50	1	080429312
* M14	1			5,30	1	080429314
M16	1			6,50	1	080429316
* M18	1			7,60	1	080429318
M20	1			9,15	1	080429320
* M22	1			11,90	1	080429322
M24	1			17,10	1	080429324
* M27	1			20,40	1	080429327
M30	1			31,00	1	080429330

8044

golfari per sollevamento
femmina, neri

CE



UNI 2948

DATI TECNICI

- coefficiente di sicurezza: 4
- trattamento termico: normalizzazione
- codice lotto di fabbricazione

ANALISI DI LABORATORIO

- analisi chimica
- analisi metallografica
- test di trazione

CERTIFICATI DISPONIBILI

- Specifica Prodotto
- Rapporto di Prova tipo 2.2 UNI EN10204
- Certificato di Controllo tipo 3.1 UNI EN10204
- Dichiarazione di Conformità CE

Ø mm	mm	WLL kg	€		
M8	1,25	80	2,43	4	080440008
M10	1,5	160	3,95	4	080440010
M12	1,75	250	6,95	4	080440012
M14	2	250	11,20	2	080440014
M16	2	400	11,30	2	080440016
M20	2,5	630	19,00	2	080440020
M24	3	1000	33,00	2	080440024



PENDENTI DI CATENA Grado 8

Ø D mm	WLL Ton		
	0° < β ≤ 45°	45° < β ≤ 60°	60° < β ≤ 90°
6	1,12	1,6	1,12
7	1,5	2,12	1,5
8	2	2,8	2
10	3,15	4,25	3,15
13	5,3	7,5	5,3
16	8	11,2	8

Ø D mm	WLL 3	
	0° < β ≤ 45°	45° < β ≤ 60°
6	2,36	1,7
7	3,15	2,24
8	4,25	3
10	6,7	4,75
13	11,2	8
16	17	11,2

8091

pendenti per sollevamento
catena a 1 braccio
grado 8

CE

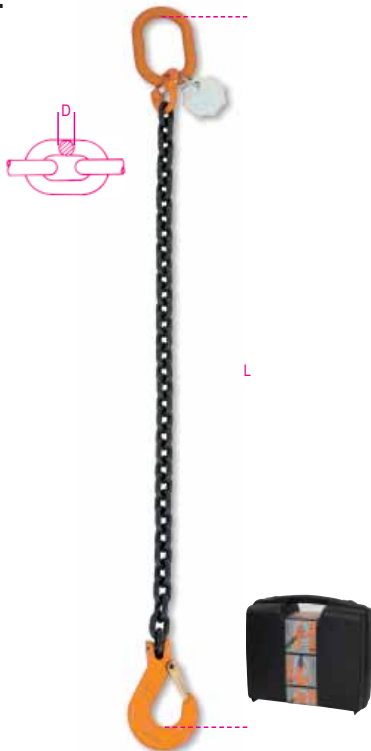

UNI EN 818-4

DATI TECNICI

- coefficiente di sicurezza: 4
- piastrina di identificazione seriale CERTIFICATI ALLEGATI
- Certificato del Fabbricante UNI EN818-4
- Dichiarazione di Conformità CE CERTIFICATI DISPONIBILI
- Specifica Prodotto

D mm	L m	WLL ton	€		
6*	1	1,12	85,50	1	080910001
6*	2	1,12	105,00	1	080910002
6*	3	1,12	124,00	1	080910003
6*	4	1,12	143,00	1	080910004
7*	1	1,5	93,50	1	080910021
7*	2	1,5	118,00	1	080910022
7*	3	1,5	142,50	1	080910023
7*	4	1,5	167,00	1	080910024
8*	1	2	104,50	1	080910041
8*	2	2	133,50	1	080910042
8*	3	2	162,50	1	080910043
8*	4	2	204,50	1	080910044
10*	1	3,15	133,50	1	080910051
10*	2	3,15	176,50	1	080910052
10*	3	3,15	232,50	1	080910053
10*	4	3,15	276,00	1	080910054
13*	1	5,3	215,00	1	080910131
13*	2	5,3	289,00	1	080910132
13*	3	5,3	359,00	1	080910133
13*	4	5,3	433,00	1	080910134
16*	1	8	421,00	1	080910161
16*	2	8	530,00	1	080910162
16*	3	8	642,00	1	080910163
16*	4	8	754,00	1	080910164
20	1	12,5	822,00	1	080910171
20	2	12,5	1.034,00	1	080910172
20	3	12,5	1.245,00	1	080910173
20	4	12,5	1.460,00	1	080910174

* Imballo in valigetta

8091SL

pendenti per sollevamento
catena a 1 braccio, gancio Self-Locking
grado 8

CE

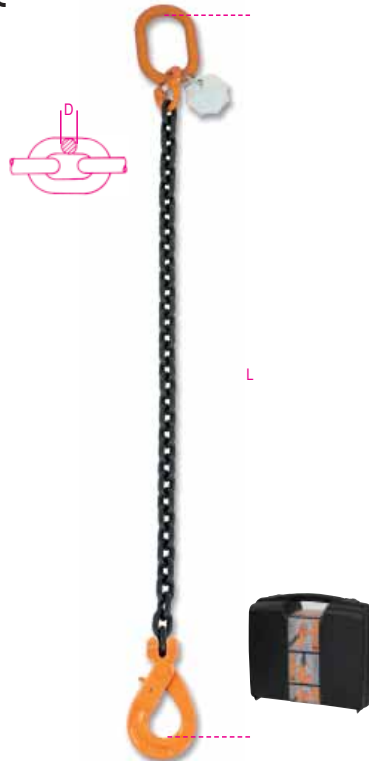

UNI EN 818-4

DATI TECNICI

- coefficiente di sicurezza: 4
- piastrina di identificazione seriale CERTIFICATI ALLEGATI
- Certificato del Fabbricante UNI EN818-4
- Dichiarazione di Conformità CE CERTIFICATI DISPONIBILI
- Specifica Prodotto

D mm	L m	WLL ton	€		
6*	1	1,12	108,00	1	080910201
6*	2	1,12	127,00	1	080910202
6*	3	1,12	146,00	1	080910203
6*	4	1,12	165,00	1	080910204
7*	1	1,5	123,50	1	080910221
7*	2	1,5	148,00	1	080910222
7*	3	1,5	172,50	1	080910223
7*	4	1,5	197,00	1	080910224
8*	1	2	134,50	1	080910241
8*	2	2	157,50	1	080910242
8*	3	2	192,50	1	080910243
8*	4	2	234,50	1	080910244
10*	1	3,15	168,00	1	080910251
10*	2	3,15	211,00	1	080910252
10*	3	3,15	267,00	1	080910253
10*	4	3,15	323,00	1	080910254
13*	1	5,3	295,00	1	080910331
13*	2	5,3	391,00	1	080910332
13*	3	5,3	442,00	1	080910333
13*	4	5,3	535,00	1	080910334
16*	1	8	555,00	1	080910361
16*	2	8	698,00	1	080910362
16*	3	8	777,00	1	080910363
16*	4	8	922,00	1	080910364
20	1	12,5	1.300,00	1	080910401
20	2	12,5	1.510,00	1	080910402
20	3	12,5	1.725,00	1	080910403
20	4	12,5	1.935,00	1	080910404

* Imballo in valigetta

8092

pendenti per sollevamento
catena a 2 bracci
grado 8

CE



UNI EN 818-4

DATI TECNICI

- coefficiente di sicurezza: 4
- piastrina di identificazione seriale CERTIFICATI ALLEGATI
- Certificato del Fabbricante UNI EN818-4
- Dichiarazione di Conformità CE CERTIFICATI DISPONIBILI
- Specifica Prodotto

D mm	L m	WLL ton	€		
6*	1	1,6	125,50	1	080920001
6*	2	1,6	164,00	1	080920002
6*	3	1,6	202,00	1	080920003
6*	4	1,6	253,00	1	080920004
7*	1	2,12	146,00	1	080920021
7*	2	2,12	195,00	1	080920022
7*	3	2,12	257,00	1	080920023
7*	4	2,12	306,00	1	080920024
8*	1	2,8	165,50	1	080920041
8*	2	2,8	223,50	1	080920042
8*	3	2,8	294,00	1	080920043
8*	4	2,8	352,00	1	080920044
10*	1	4,25	239,50	1	080920051
10*	2	4,25	325,00	1	080920052
10*	3	4,25	409,00	1	080920053
10*	4	4,25	495,00	1	080920054
13*	1	7,5	381,00	1	080920131
13*	2	7,5	526,00	1	080920132
13	3	7,5	652,00	1	080920133
13	4	7,5	850,00	1	080920134
16*	1	11,2	764,00	1	080920161
16	2	11,2	1.018,00	1	080920162
16	3	11,2	1.240,00	1	080920163
16	4	11,2	1.465,00	1	080920164
20	2	17,0	2.055,00	1	080920172
20	3	17,0	2.480,00	1	080920173
20	4	17,0	2.910,00	1	080920174

* Imballo in valigetta





8092SL

pendenti per sollevamento
catena a 2 bracci, ganci Self-Locking
grado 8

CE



UNI EN 818-4

DATI TECNICI

- coefficiente di sicurezza: 4
 - piastrina di identificazione seriale
- CERTIFICATI ALLEGATI**
- Certificato del Fabbricante UNI EN818-4
 - Dichiarazione di Conformità CE
- CERTIFICATI DISPONIBILI**
- Specifica Prodotto

D mm	L m	WLL ton	€		
6*	1	1,6	170,00	1	080920201
6*	2	1,6	200,50	1	080920202
6*	3	1,6	239,00	1	080920203
6*	4	1,6	298,00	1	080920204
7*	1	2,12	205,00	1	080920221
7*	2	2,12	244,50	1	080920222
7*	3	2,12	316,00	1	080920223
7*	4	2,12	365,00	1	080920224
8*	1	2,8	213,50	1	080920241
8*	2	2,8	284,00	1	080920242
8*	3	2,8	342,00	1	080920243
8*	4	2,8	412,00	1	080920244
10*	1	4,25	334,00	1	080920251
10*	2	4,25	394,00	1	080920252
10*	3	4,25	478,00	1	080920253
10*	4	4,25	589,00	1	080920254
13*	1	7,5	586,00	1	080920331
13*	2	7,5	691,00	1	080920332
13*	3	7,5	857,00	1	080920333
13*	4	7,5	1.054,00	1	080920334
16*	1	11,2	1.100,00	1	080920361
16*	2	11,2	1.355,00	1	080920362
16*	3	11,2	1.580,00	1	080920363
16*	4	11,2	1.800,00	1	080920364
20	2	17,0	3.330,00	1	080920402
20	3	17,0	3.750,00	1	080920403
20	4	17,0	4.180,00	1	080920404

* Imballo in valigetta

8094

pendenti per sollevamento
catena a 4 bracci
grado 8

CE



UNI EN 818-4

DATI TECNICI

- coefficiente di sicurezza: 4
 - piastrina di identificazione seriale
- CERTIFICATI ALLEGATI**
- Certificato del Fabbricante UNI EN818-4
 - Dichiarazione di Conformità CE
- CERTIFICATI DISPONIBILI**
- Specifica Prodotto

D mm	L m	WLL ton	€		
6*	1	2,36	261,00	1	080940001
6*	2	2,36	350,00	1	080940002
6*	3	2,36	427,00	1	080940003
6*	4	2,36	500,00	1	080940004
7*	1	3,15	306,00	1	080940021
7*	2	3,15	404,00	1	080940022
7*	3	3,15	499,00	1	080940023
7*	4	3,15	597,00	1	080940024
8*	1	4,25	369,00	1	080940041
8*	2	4,25	482,00	1	080940042
8*	3	4,25	598,00	1	080940043
8	4	4,25	744,00	1	080940044
10*	1	6,7	486,00	1	080940051
10	2	6,7	671,00	1	080940052
10	3	6,7	860,00	1	080940053
10	4	6,7	1.032,00	1	080940054
13	1	11,2	810,00	1	080940131
13	2	11,2	1.104,00	1	080940132
13	3	11,2	1.395,00	1	080940133
13	4	11,2	1.690,00	1	080940134
16	1	17	1.590,00	1	080940161
16	2	17	2.035,00	1	080940162
16	3	17	2.485,00	1	080940163
16	4	17	2.930,00	1	080940164
20	2	26,5	3.730,00	1	080940172
20	3	26,5	4.580,00	1	080940173
20	4	26,5	5.420,00	1	080940174

* Imballo in valigetta



8094SL

pendenti per sollevamento
catena a 4 bracci, ganci Self-Locking
grado 8

CE



UNI EN 818-4

DATI TECNICI

- coefficiente di sicurezza: 4
 - piastrina di identificazione seriale
- CERTIFICATI ALLEGATI**
- Certificato del Fabbricante UNI EN818-4
 - Dichiarazione di Conformità CE
- CERTIFICATI DISPONIBILI**
- Specifica Prodotto

D mm	L m	WLL ton	€		
6*	1	2,36	350,00	1	080940201
6*	2	2,36	439,00	1	080940202
6*	3	2,36	516,00	1	080940203
6*	4	2,36	589,00	1	080940204
7*	1	3,15	424,00	1	080940221
7*	2	3,15	522,00	1	080940222
7*	3	3,15	618,00	1	080940223
7*	4	3,15	716,00	1	080940224
8*	1	4,25	465,00	1	080940241
8*	2	4,25	578,00	1	080940242
8*	3	4,25	717,00	1	080940243
8	4	4,25	863,00	1	080940244
10*	1	6,7	633,00	1	080940251
10	2	6,7	809,00	1	080940252
10	3	6,7	1.007,00	1	080940253
10	4	6,7	1.179,00	1	080940254
13	1	11,2	1.145,00	1	080940331
13	2	11,2	1.440,00	1	080940332
13	3	11,2	1.730,00	1	080940333
13	4	11,2	2.025,00	1	080940334
16	1	17	2.150,00	1	080940361
16	2	17	2.600,00	1	080940362
16	3	17	3.050,00	1	080940363
16	4	17	3.490,00	1	080940364
20	2	26,5	5.640,00	1	080940402
20	3	26,5	6.480,00	1	080940403
20	4	26,5	7.330,00	1	080940404

* Imballo in valigetta

8096

pendenti per sollevamento
con ganci accorciatori con sicura
catena ad 1 braccio, grado 8

CE



UNI EN 818-4

DATI TECNICI

- coefficiente di sicurezza: 4
 - piastrina di identificazione seriale
- CERTIFICATI ALLEGATI**
- Certificato del Fabbricante UNI EN818-4
 - Dichiarazione di Conformità CE
- CERTIFICATI DISPONIBILI**
- Specifica Prodotto

D mm	L m	WLL ton	€		
6*	1	1,12	101,50	1	080960001
6*	2	1,12	120,50	1	080960002
6*	3	1,12	139,50	1	080960003
6*	4	1,12	155,00	1	080960004
7*	1	1,5	112,50	1	080960021
7*	2	1,5	137,00	1	080960022
7*	3	1,5	156,50	1	080960023
7*	4	1,5	181,00	1	080960024
8*	1	2	124,00	1	080960041
8*	2	2	153,00	1	080960042
8*	3	2	182,00	1	080960043
8*	4	2	224,00	1	080960044
10*	1	3,15	171,50	1	080960051
10*	2	3,15	227,50	1	080960052
10*	3	3,15	270,00	1	080960053
10*	4	3,15	313,00	1	080960054
13*	1	5,3	281,00	1	080960131
13*	2	5,3	333,00	1	080960132
13*	3	5,3	403,00	1	080960133
13*	4	5,3	499,00	1	080960134
16*	1	8	553,00	1	080960161
16*	2	8	629,00	1	080960162
16*	3	8	741,00	1	080960163
16	4	8	883,00	1	080960164
20	1	12,5	1.122,00	1	080960171
20	2	12,5	1.335,00	1	080960172
20	3	12,5	1.545,00	1	080960173
20	4	12,5	1.755,00	1	080960174

* Imballo in valigetta

8096SL

pendenti per sollevamento
con gancio Self-Locking e accorciatore
catena ad 1 braccio, grado 8

CE



UNI EN 818-4

DATI TECNICI

- coefficiente di sicurezza: 4
 - piastrina di identificazione seriale
- CERTIFICATI ALLEGATI**
- Certificato del Fabbricante UNI EN818-4
 - Dichiarazione di Conformità CE
- CERTIFICATI DISPONIBILI**
- Specifica Prodotto

D mm	L m	WLL ton	€		
6*	1	1,12	120,00	1	080960201
6*	2	1,12	139,00	1	080960202
6*	3	1,12	158,00	1	080960203
6*	4	1,12	177,00	1	080960204
7*	1	1,5	137,00	1	080960221
7*	2	1,5	161,50	1	080960222
7*	3	1,5	186,00	1	080960223
7*	4	1,5	210,50	1	080960224
8*	1	2	148,00	1	080960241
8*	2	2	177,00	1	080960242
8*	3	2	206,00	1	080960243
8*	4	2	248,00	1	080960244
10*	1	3,15	206,00	1	080960251
10*	2	3,15	262,00	1	080960252
10*	3	3,15	305,00	1	080960253
10*	4	3,15	348,00	1	080960254
13*	1	5,3	361,00	1	080960331
13*	2	5,3	435,00	1	080960332
13*	3	5,3	505,00	1	080960333
13*	4	5,3	579,00	1	080960334
16*	1	8	688,00	1	080960361
16*	2	8	797,00	1	080960362
16*	3	8	909,00	1	080960363
16	4	8	1.017,00	1	080960364
20	1	12,5	1.600,00	1	080960401
20	2	12,5	1.810,00	1	080960402
20	3	12,5	2.020,00	1	080960403
20	4	12,5	2.235,00	1	080960404

* Imballo in valigetta

8097

pendenti per sollevamento
con ganci accorciatori con sicura
catena a 2 bracci, grado 8

CE



UNI EN 818-4

DATI TECNICI

- coefficiente di sicurezza: 4
 - piastrina di identificazione seriale
- CERTIFICATI ALLEGATI**
- Certificato del Fabbricante UNI EN818-4
 - Dichiarazione di Conformità CE
- CERTIFICATI DISPONIBILI**
- Specifica Prodotto

D mm	L m	WLL ton	€		
6*	1	1,6	157,50	1	080970001
6*	2	1,6	188,00	1	080970002
6*	3	1,6	233,50	1	080970003
6*	4	1,6	277,00	1	080970004
7*	1	2,12	183,00	1	080970021
7*	2	2,12	235,50	1	080970022
7*	3	2,12	284,00	1	080970023
7*	4	2,12	333,00	1	080970024
8*	1	2,8	204,50	1	080970041
8*	2	2,8	264,00	1	080970042
8*	3	2,8	333,00	1	080970043
8*	4	2,8	391,00	1	080970044
10*	1	4,25	315,00	1	080970051
10*	2	4,25	401,00	1	080970052
10*	3	4,25	484,00	1	080970053
10*	4	4,25	570,00	1	080970054
13*	1	7,5	511,00	1	080970131
13*	2	7,5	658,00	1	080970132
13	3	7,5	791,00	1	080970133
13	4	7,5	938,00	1	080970134
16	1	11,2	991,00	1	080970161
16	2	11,2	1.215,00	1	080970162
16	3	11,2	1.440,00	1	080970163
16	4	11,2	1.660,00	1	080970164
20	2	17,0	2.375,00	1	080970172
20	3	17,0	2.800,00	1	080970173
20	4	17,0	3.220,00	1	080970174

* Imballo in valigetta



8097SL

pendenti per sollevamento
con ganci Self-Locking e accorciatori
catena a 2 bracci, grado 8

CE



UNI EN 818-4

DATI TECNICI

- coefficiente di sicurezza: 4
- piastrina di identificazione seriale
- CERTIFICATI ALLEGATI
- Certificato del Fabbricante UNI EN818-4
- Dichiarazione di Conformità CE
- CERTIFICATI DISPONIBILI
- Specifica Prodotto

D mm	L m	WLL ton	€	📄	📁
6*	1	1,6	194,00	1	080970201
6*	2	1,6	224,50	1	080970202
6*	3	1,6	271,00	1	080970203
6*	4	1,6	322,00	1	080970204
7*	1	2,12	232,50	1	080970221
7*	2	2,12	285,00	1	080970222
7*	3	2,12	334,00	1	080970223
7*	4	2,12	383,00	1	080970224
8*	1	2,8	253,00	1	080970241
8*	2	2,8	312,00	1	080970242
8*	3	2,8	381,00	1	080970243
8*	4	2,8	439,00	1	080970244
10*	1	4,25	384,00	1	080970251
10*	2	4,25	470,00	1	080970252
10*	3	4,25	553,00	1	080970253
10*	4	4,25	639,00	1	080970254
13*	1	7,5	671,00	1	080970331
13*	2	7,5	818,00	1	080970332
13	3	7,5	995,00	1	080970333
13	4	7,5	1.098,00	1	080970334
16	1	11,2	1.325,00	1	080970361
16	2	11,2	1.550,00	1	080970362
16	3	11,2	1.775,00	1	080970363
16	4	11,2	1.930,00	1	080970364
20	2	17,0	3.330,00	1	080970402
20	3	17,0	3.750,00	1	080970403
20	4	17,0	4.180,00	1	080970404

* Imballo in valigetta

8098

pendenti per sollevamento
con ganci accorciatori con sicura
catena a 4 bracci, grado 8

CE



UNI EN 818-4

DATI TECNICI

- coefficiente di sicurezza: 4
- piastrina di identificazione seriale
- CERTIFICATI ALLEGATI
- Certificato del Fabbricante UNI EN818-4
- Dichiarazione di Conformità CE
- CERTIFICATI DISPONIBILI
- Specifica Prodotto

D mm	L m	WLL ton	€	📄	📁
6*	1	2,36	324,00	1	080980001
6*	2	2,36	398,00	1	080980002
6*	3	2,36	472,00	1	080980003
6*	4	2,36	548,00	1	080980004
7*	1	3,15	380,00	1	080980021
7*	2	3,15	459,00	1	080980022
7*	3	3,15	554,00	1	080980023
7*	4	3,15	652,00	1	080980024
8*	1	4,25	424,00	1	080980041
8*	2	4,25	537,00	1	080980042
8*	3	4,25	653,00	1	080980043
8	4	4,25	799,00	1	080980044
10*	1	6,7	586,00	1	080980051
10	2	6,7	788,00	1	080980052
10	3	6,7	960,00	1	080980053
10	4	6,7	1.132,00	1	080980054
13	1	11,2	986,00	1	080980131
13	2	11,2	1.280,00	1	080980132
13	3	11,2	1.590,00	1	080980133
13	4	11,2	1.865,00	1	080980134
16	1	17	1.985,00	1	080980161
16	2	17	2.430,00	1	080980162
16	3	17	2.880,00	1	080980163
16	4	17	3.330,00	1	080980164
20	2	26,5	4.720,00	1	080980172
20	3	26,5	5.570,00	1	080980173
20	4	26,5	6.420,00	1	080980174

* Imballo in valigetta

8098SL

pendenti per sollevamento
con ganci Self-Locking e accorciatori
catena a 4 bracci, grado 8

CE



UNI EN 818-4

DATI TECNICI

- coefficiente di sicurezza: 4
- piastrina di identificazione seriale
- CERTIFICATI ALLEGATI
- Certificato del Fabbricante UNI EN818-4
- Dichiarazione di Conformità CE
- CERTIFICATI DISPONIBILI
- Specifica Prodotto

D mm	L m	WLL ton	€	📄	📁
6*	1	2,36	398,00	1	080980201
6*	2	2,36	487,00	1	080980202
6*	3	2,36	545,00	1	080980203
6*	4	2,36	637,00	1	080980204
7*	1	3,15	479,00	1	080980221
7*	2	3,15	558,00	1	080980222
7*	3	3,15	653,00	1	080980223
7*	4	3,15	751,00	1	080980224
8*	1	4,25	543,00	1	080980241
8*	2	4,25	633,00	1	080980242
8	3	4,25	749,00	1	080980243
8*	4	4,25	895,00	1	080980244
10*	1	6,7	724,00	1	080980251
10	2	6,7	926,00	1	080980252
10	3	6,7	1.098,00	1	080980253
10	4	6,7	1.270,00	1	080980254
13	1	11,2	1.305,00	1	080980331
13	2	11,2	1.600,00	1	080980332
13	3	11,2	1.910,00	1	080980333
13	4	11,2	2.185,00	1	080980334
16	1	17	2.540,00	1	080980361
16	2	17	2.990,00	1	080980362
16	3	17	3.440,00	1	080980363
16	4	17	3.870,00	1	080980364
20	2	26,5	6.630,00	1	080980402
20	3	26,5	7.480,00	1	080980403
20	4	26,5	8.330,00	1	080980404

* Imballo in valigetta

8100

catene per sollevamento,
acciaio legato ad alta resistenza
grado 8

CE



EN 818-2

DATI TECNICI

- coefficiente di sicurezza: 4
- trattamento termico: bonifica
- codice lotto di fabbricazione

ANALISI DI LABORATORIO

- analisi chimica
- analisi metallografica
- test di trazione

CERTIFICATI DISPONIBILI

- Specifica Prodotto
- Rapporto di Prova tipo 2.2 UNI EN10204
- Certificato del Fabbricante EN818-2
- Dichiarazione di Conformità CE

WLL kg	Ø mm	A mm	B min mm	€/m		
1120	6	18	7,8	20,20	1	081000011
1500	7	21	11,0	26,00	1	081000016
2000	8	24	12,0	30,50	1	081000020
3150	10	30	14,5	45,50	1	081000032
5300	13	39	20,0	78,00	1	081000053
8000	16	48	20,8	118,50	1	081000080
12500	20	60	26,0	212,00	1	081000125

* ATTENZIONE: il prodotto viene consegnato in un unico spezzone di catena, salvo diversa indicazione in fase d'ordine!

8085R

campanelle per sollevamento,
acciaio legato ad alta resistenza
grado 8

CE



EN 1677-4

DATI TECNICI

- coefficiente di sicurezza: 4
- trattamento termico: bonifica
- codice lotto fabbricazione

ANALISI DI LABORATORIO

- analisi chimica, analisi metallografica
- test carico di prova (WLL x 2,5)
- test di trazione

- test di fatica (min. 20.000 cicli)

CERTIFICATI DISPONIBILI

- Specifica Prodotto
- Rapporto di Prova tipo 2.2 UNI EN10204
- Certificato di Controllo tipo 3.1 UNI EN10204
- Dichiarazione di Conformità CE

WLL kg	Ø mm	A mm	B mm	€		
* 1600	7	110	60	10,70	1	080850215
2120	8	110	60	15,20	1	080850220
3150	10	135	75	21,50	1	080850232
5300	13	160	90	37,50	1	080850253
8000	16	180	100	75,50	1	080850280
11200	19	200	110	122,50	1	080850311
16000	20	260	140	201,50	1	080850316
17000	22	300	160	286,00	1	080850317

Il carico di lavoro è relativo all'utilizzo con imbragature ad 1 braccio. (*) Abbinata a catena Ø 6, WLL= 1120 kg.

8086

campanelle per sollevamento triple,
acciaio legato ad alta resistenza
grado 8

CE



EN 1677-4

DATI TECNICI

- coefficiente di sicurezza: 4
 - trattamento termico: bonifica
 - codice lotto fabbricazione
- ### ANALISI DI LABORATORIO
- analisi chimica, analisi metallografica
 - test carico di prova (WLL x 2,5)
 - test di trazione
 - test di fatica (min. 20.000 cicli)
- ### CERTIFICATI DISPONIBILI
- Specifica Prodotto
 - Rapporto di Prova tipo 2.2 UNI EN10204
 - Certificato di Controllo tipo 3.1 UNI EN10204
 - Dichiarazione di Conformità CE

WLL kg	Ø mm	B mm	C mm	€		
* 3150	7	135	75	69,50	1	080860021
4250	8	160	90	107,00	1	080860042
6700	10	180	100	137,50	1	080860067
11200	13	200	110	223,00	1	080860100
17000	16	260	140	326,00	1	080860117
21200	18	340	180	583,00	1	080860121
26500	20	350	190	827,00	1	080860126

Il carico di lavoro è riferito a imbragature 3 o 4 bracci e angolo B inferiore a 45°.

(*) Abbinata a catena Ø 6mm, WLL= 2360 kg

8090R

maglie di giunzione per sollevamento,
acciaio legato ad alta resistenza
grado 8

CE

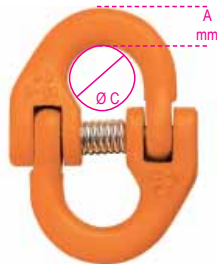

EN 1677-1

DATI TECNICI

- coefficiente di sicurezza: 4
 - trattamento termico: bonifica
 - codice lotto fabbricazione
- ### ANALISI DI LABORATORIO
- analisi chimica, analisi metallografica
 - test carico di prova (WLL x 2,5)
 - test di trazione
 - test di fatica (min. 20.000 cicli)
- ### CERTIFICATI DISPONIBILI
- Specifica Prodotto
 - Rapporto di Prova tipo 2.2 UNI EN10204
 - Certificato di Controllo tipo 3.1 UNI EN10204
 - Dichiarazione di Conformità CE

WLL kg	Ø mm	ØC max mm	A mm	€		
1120	6	13	7,5	9,10	1	080900111
1500	7	18	9	11,80	1	080900115
2000	8	18	11	14,40	1	080900120
3150	10	22	13,0	17,60	1	080900131
5300	13	30	16	32,00	1	080900153
8000	16	32	22	69,50	1	080900180
12500	20	40	25	159,00	1	080900312

8060R

ganci per sollevamento
tipo Clevis a forcella,
acciaio legato ad alta resistenza
grado 8

CE

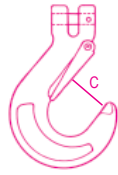

EN 1677-2

DATI TECNICI

- coefficiente di sicurezza: 4
 - trattamento termico: bonifica
 - codice lotto perno, linguetta, corpo
- ### ANALISI DI LABORATORIO
- analisi chimica, analisi metallografica
 - test di trazione
 - test di fatica (min. 20.000 cicli)
 - carico di collaudo (100% del lotto)
- ### CERTIFICATI DISPONIBILI
- Specifica Prodotto
 - Rapporto di Prova tipo 2.2 UNI EN10204
 - Certificato di Controllo tipo 3.1 UNI EN10204
 - Dichiarazione di Conformità CE

WLL kg	Ø mm	C mm	€		
1120	6	19	17,10	1	080600111
1500	7	19	18,30	1	080600115
2000	8	21	19,10	1	080600120
3150	10	27	33,00	1	080600132
5300	13	35	52,50	1	080600153
8000	16	48	167,00	1	080600180
12500	20	54	297,00	1	080600225

8058R

ganci per sollevamento
tipo self-locking a forcella
acciaio legato ad alta resistenza
grado 8

CE

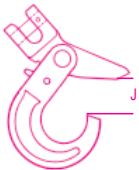

EN 1677-3

DATI TECNICI

- coefficiente di sicurezza: 4
 - trattamento termico: bonifica
 - codice lotto fabbricazione
- ### ANALISI DI LABORATORIO
- analisi chimica, analisi metallografica
 - test di trazione
 - test di fatica (min. 20.000 cicli)
 - carico di collaudo (100% del lotto)
- ### CERTIFICATI DISPONIBILI
- Specifica Prodotto
 - Rapporto di Prova tipo 2.2 UNI EN10204
 - Certificato di Controllo tipo 3.1 UNI EN10204
 - Dichiarazione di Conformità CE

WLL kg	Ø mm	J min mm	€		
1120	6	28	36,50	1	080580112
2000	7-8	34	44,50	1	080580120
3150	10	44	69,50	1	080580132
5300	13	52	137,50	1	080580153
8000	16	67	310,00	1	080580180
12500	20	77	774,00	1	080580225

8061R

ganci accorciatori a forcella
con sicura di bloccaggio,
acciaio legato ad alta resistenza
grado 8

CE



EN 1677-1

DATI TECNICI

- coefficiente di sicurezza: 4
- trattamento termico: bonifica
- codice lotto fabbricazione

ANALISI DI LABORATORIO

- analisi chimica, analisi metallografica
- test di trazione
- test di fatica (min. 20.000 cicli)
- carico di collaudo (100% del lotto)

CERTIFICATI DISPONIBILI

- Specifica Prodotto
- Rapporto di Prova tipo 2.2 UNI EN10204
- Certificato di Controllo tipo 3.1 UNI EN10204
- Dichiarazione di Conformità CE

WLL kg	Ø mm	E mm	€	🚚	🏠
1120	6	8	12,70	1	080610211
2000	7-8	11	14,50	1	080610220
3150	10	13	26,50	1	080610231
5300	13	17	46,50	1	080610253
8000	16	20	104,50	1	080610280
12500	20	24	249,00	1	080610312

8052

ganci per sollevamento ad occhio,
acciaio legato ad alta resistenza
grado 8

CE



EN 1677-2

DATI TECNICI

- coefficiente di sicurezza: 4
- trattamento termico: bonifica
- codice lotto fabbricazione

ANALISI DI LABORATORIO

- analisi chimica, analisi metallografica
- test carico di prova (2,5 x wll) • test di trazione
- test di fatica (min. 20.000 cicli)
- carico di collaudo (100% del lotto)

CERTIFICATI DISPONIBILI

- Specifica Prodotto
- Rapporto di Prova tipo 2.2 UNI EN10204
- Certificato di Controllo tipo 3.1 UNI EN10204
- Dichiarazione di Conformità CE

WLL kg	C mm	€	🚚	🏠
8052 0,8	800 18	6,50	1	080520008
8052 1,12	1120 22,5	8,70	1	080520011
8052 2	2000 30	18,40	1	080520020
8052 3,15	3150 36	28,00	1	080520031
8052 4	4000 39,5	36,50	1	080520040

WLL kg	A mm	E mm	€	🚚	🏠
8055S 5,4	5400 32	71,00	1	080550145	
8055S 8,0	8000 43	124,00	1	080550170	
8055S 11,5	11500 53	247,00	1	080550215	
8055S 16,0	16000 58	332,00	1	080550260	
8055S 22,0	22000 78	778,00	1	080550320	

8057R

ganci per sollevamento
tipo self-locking ad occhio,
acciaio legato ad alta resistenza
grado 8

CE



EN 1677-3

DATI TECNICI

- coefficiente di sicurezza: 4
- trattamento termico: bonifica
- codice lotto fabbricazione

ANALISI DI LABORATORIO

- analisi chimica, analisi metallografica
- test di trazione
- test di fatica (min. 20.000 cicli)
- carico di collaudo (100% del lotto)

CERTIFICATI DISPONIBILI

- Specifica Prodotto
- Rapporto di Prova tipo 2.2 UNI EN10204
- Certificato di Controllo tipo 3.1 UNI EN10204
- Dichiarazione di Conformità CE

WLL kg	Ø mm	J min mm	ØB mm	€	🚚	🏠
1120	6	28	22	29,50	1	080570112
2000	7-8	34	25	35,00	1	080570120
3150	10	44	32	63,00	1	080570132
5300	13	54	40	220,00	1	080570153

8063

ganci per sollevamento
orientabili (non sotto carico)
acciaio legato alta resistenza
grado 8

CE

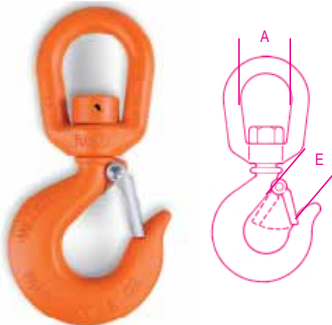

EN 1677-1

DATI TECNICI

- coefficiente di sicurezza: 4
- trattamento termico: bonifica
- codice lotto fabbricazione

ANALISI DI LABORATORIO

- analisi chimica, analisi metallografica
- test di trazione
- test di fatica (min. 20.000 cicli)
- carico di collaudo (100% del lotto)

CERTIFICATI DISPONIBILI

- Specifica Prodotto
- Rapporto di Prova tipo 2.2 UNI EN10204
- Certificato di Controllo tipo 3.1 UNI EN10204
- Dichiarazione di Conformità CE

WLL kg	A mm	E mm	€	🚚	🏠
800	32	20,5	14,50	1	080630008
1120	38	20,5	18,30	1	080630011
2000	44,5	22	22,30	1	080630020
3150	44,5	27	27,50	1	080630031

8063SL

ganci autoserranti
orientabili (non sotto carico)
acciaio legato alta resistenza
grado 8

CE

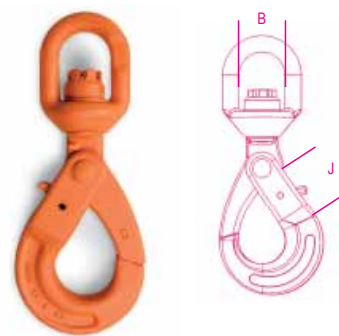

EN 1677-1

Dati tecnici

- Coefficiente di sicurezza: 4
- Trattamento termico: bonifica
- Codice lotto fabbricazione

Analisi di laboratorio

- Analisi chimica, analisi metallografica
- Test di trazione
- Test di fatica (min. 20.000 cicli)
- Carico di collaudo (100% del lotto)

Certificati disponibili

- Specifica Prodotto
- Rapporto di Prova tipo 2.2 UNI EN10204
- Certificato di Controllo tipo 3.1 UNI EN10204
- Dichiarazione di Conformità CE

WLL kg	Ø mm	B mm	J mm	€	🚚	🏠
1120	6	32	45	38,00	1	080630311
2000	8	35	59	53,00	1	080630320
3150	10	42	54	92,00	1	080630331
5300	13	49	83	140,50	1	080630353

8064S

ganci per sollevamento
orientabili (non sotto carico)
acciaio al carbonio
grado 4

CE

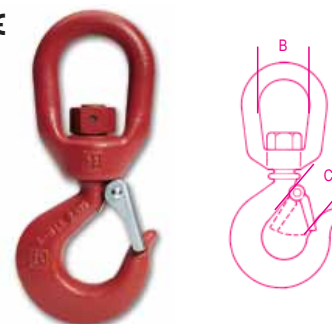

EN 1677-5

DATI TECNICI

- coefficiente di sicurezza: 5
- trattamento termico: bonifica
- codice lotto fabbricazione

ANALISI DI LABORATORIO

- analisi chimica, analisi metallografica
- test carico di prova (WLL x 2,5)
- test di trazione
- test di fatica (min. 20.000 cicli)

CERTIFICATI DISPONIBILI

- Specifica Prodotto
- Rapporto di Prova tipo 2.2 UNI EN10204
- Certificato di Controllo tipo 3.1 UNI EN10204
- Dichiarazione di Conformità CE

WLL kg	B mm	C mm	€	🚚	🏠
800	31	20	35,50	1	080640107
1000	40	22	50,00	1	080640110
1600	47	23	65,50	1	080640115
2000	47	27	71,50	1	080640120
3200	64	35	125,00	1	080640130
5000	77	43	228,50	1	080640150
7500	90	53	333,00	1	080640175
10000	96	58	553,00	1	080640199

8065SC

ganci per sollevamento
girevoli sotto carico, con cuscinetto
acciaio al carbonio
grado 4

CE

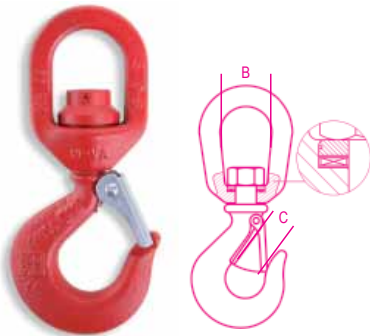

EN 1677-5

DATI TECNICI

- coefficiente di sicurezza: 5
- trattamento termico: bonifica
- codice lotto fabbricazione

ANALISI DI LABORATORIO

- analisi chimica, analisi metallografica
- test carico di prova (WLL x 2,5)
- test di trazione
- test di fatica (min. 20.000 cicli)

CERTIFICATI DISPONIBILI

- Specifica Prodotto
- Rapporto di Prova tipo 2.2 UNI EN10204
- Certificato di Controllo tipo 3.1 UNI EN10204
- Dichiarazione di Conformità CE

WLL kg	B mm	C mm	€	📦	🚚
800	38	20	71,00	1	080650107
1000	38	22	77,50	1	080650110
1600	47	23	96,00	1	080650115
2000	47	27	109,50	1	080650120
3200	54	35	192,50	1	080650130
5000	72	43	285,00	1	080650150
7500	82	53	483,00	1	080650175

8062

ganci scorsoi,
acciaio legato ad alta resistenza

CE

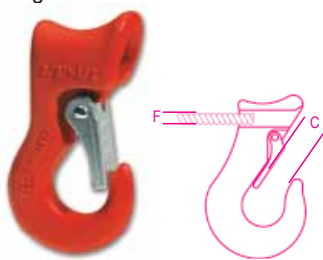

DATI TECNICI

- coefficiente di sicurezza: 5
- trattamento termico: bonifica
- codice lotto fabbricazione

ANALISI DI LABORATORIO

- analisi chimica, analisi metallografica
- test carico di prova (WLL x 2,5)
- test di trazione

CERTIFICATI DISPONIBILI

- Specifica Prodotto
- Rapporto di Prova tipo 2.2 UNI EN10204
- Certificato di Controllo tipo 3.1 UNI EN10204
- Dichiarazione di Conformità CE

WLL kg	C mm	F mm	€	📦	🚚
1500	19	10-13	43,00	1	080620013
2000	21	16	60,50	1	080620016
3000	26	18	101,00	1	080620018

8051S

ganci per sollevamento con sicura
acciaio al carbonio, Grado 4
zincati

CE



DATI TECNICI

- coefficiente di sicurezza: 4
- trattamento termico: normalizzazione
- codice lotto di fabbricazione

ANALISI DI LABORATORIO

- analisi chimica
- analisi metallografica
- test di trazione

CERTIFICATI DISPONIBILI

- Specifica Prodotto
- Rapporto di Prova tipo 2.2 UNI EN10204
- Certificato di Controllo tipo 3.1 UNI EN10204
- Dichiarazione di Conformità CE

WLL kg	C mm	F mm	€	📦	🚚
250	14	12	3,15	10	080510202
500	18	16,5	6,95	5	080510205

confezioni appendibili



WLL kg	📦	€	📦	🚚
250	1	4,45	1	080519202
500	1	8,60	1	080519205

8134

Sollevatori magnetici permanenti

CE

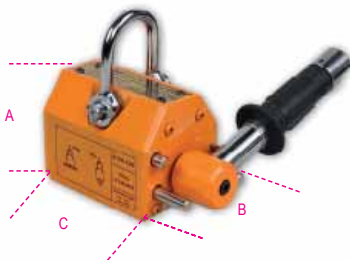

EN13155

Dati tecnici:

- Coefficiente di sicurezza: 3
- Piastra di identificazione seriale

Certificati disponibili:

- Certificato del Fabricante
- Dichiarazione di Conformità CE
- Rapporto di Prova tipo 2.2 UNI EN10204
- Manuale d'uso e manutenzione

WLL kg	A mm	B mm	C mm	€	📦	🚚
100	70	64	92	457,00	1	081340010
300	96	88	165	802,00	1	081340030
600	120	118	236	1.490,00	1	081340060
1000	168	168	264	2.465,00	1	081340100

8135

pinze di sollevamento lamiera
con anello di sospensione snodato

CE



EN13155

Dati tecnici:

- Coefficiente di sicurezza: 3
- Piastra di identificazione seriale

Certificati disponibili:

- Certificato del Fabricante
- Dichiarazione di Conformità CE
- Rapporto di Prova tipo 2.2 UNI EN10204

WLL t	A mm	E mm	kg	€	📦	🚚
0,75	0-15	2	2	131,00	1	081350005
1,0	0-20	5	5	177,00	1	081350010
2,0	0-25	8	8	263,00	1	081350020
3,0	0-30	15	15	446,00	1	081350032
5,0	0-50	23	23	627,00	1	081350050

8143

paranchi manuali a catena

CE



EN13157

Certificato TUV

Dati tecnici:

- Coefficiente di sicurezza: 4
- Piastra di identificazione seriale

Certificati disponibili:

- Certificato del Fabricante
- Dichiarazione di Conformità CE
- Rapporto di Prova tipo 2.2 UNI EN10204
- Specifica Prodotto

WLL t	📦	sforz / effort kg	€	📦	🚚
0,5	3	27	211,50	1	081430005
1	3	44	249,50	1	081430010
1,5	3	44	330,00	1	081430015
2	3	44	362,00	1	081430020
3	3	45	467,00	1	081430030
5	3	47	694,00	1	081430050

0,5	6	27	317,00	1	081430105
1	6	44	356,00	1	081430110
1,5	6	44	462,00	1	081430115
2	6	44	502,00	1	081430120
3	6	45	718,00	1	081430130
5	6	47	1.018,00	1	081430150

8146

paranchi a leva

CE



EN13157
Certificato TUV

DATI TECNICI

- coefficiente di sicurezza: 4
- piastra di identificazione seriale

CERTIFICATI DISPONIBILI

- Certificato del Fabbricante
- Dichiarazione di Conformità CE
- Rapporto di Prova tipo 2.2 UNI EN10204
- Specifica Prodotto

WLL	t	L m	sforzo / effort	€		
			kg			
0,75	1,5	21*	258,00	1	081460008	
1,5	1,5	41*	367,00	1	081460015	
3,0	1,5	41	491,00	1	081460030	
6,0	1,5	46	798,00	1	081460060	

0,75	3,0	21*	289,00	1	081460108
1,5	3,0	41*	408,00	1	081460115
3,0	3,0	41	563,00	1	081460130
6,0	3,0	46	957,00	1	081460160

H= distanza minima tra i ganci

* con sistema di protezione da sovraccarico

8146C

paranchi a leva compatti

CE



EN13157
Certificato TUV

DATI TECNICI

- Coefficiente di sicurezza: 4
- Piastra di identificazione seriale

Certificati disponibili:

- Certificato del Fabbricante
- Dichiarazione di Conformità CE
- Rapporto di Prova tipo 2.2 UNI EN10204
- Specifica Prodotto

WLL	t	L m	sforzo / effort	€		
			kg			
0,25	1,5	20,7	237,50	1	081460002	

H= distanza minima tra i ganci

8147C

carrelli di traslazione a catena per paranchi manuali

Idonei per travi strutturali come ad esempio travi INP, IPB, IPE, HEA, HEB

CE



EN 13157

Dati tecnici:

- Coefficiente di sicurezza: 4
- Piastra di identificazione seriale

Certificati disponibili:

- Certificato del Fabbricante
- Dichiarazione di Conformità CE
- Rapporto di Prova tipo 2.2 UNI EN10204
- Specifica Prodotto

WLL	t	L min	L max	Lm	€		
		mm	mm	mm			
1,0	58	220	3	264,00	1	081470510	
2,0	66	220	3	338,00	1	081470520	
3,0	74	220	3	517,00	1	081470530	
5,0	90	220	3	713,00	1	081470550	

Articolo fornito smontato: deve essere assemblato prima dell'utilizzo in accordo al manuale istruzioni.

8147S

carrelli di traslazione a spinta per paranchi manuali

Idonei per travi strutturali come ad esempio travi INP, IPB, IPE, HEA, HEB

CE

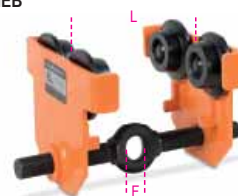

EN 13157

Dati tecnici:

- Coefficiente di sicurezza: 4
- Piastra di identificazione seriale

Certificati disponibili:

- Certificato del Fabbricante
- Dichiarazione di Conformità CE
- Rapporto di Prova tipo 2.2 UNI EN10204
- Specifica Prodotto

WLL	t	L min	L max	øF	€		
		mm	mm	mm			
0,5	50	220	25	170,00	1	081470005	
1,0	58	220	30	217,50	1	081470010	
2,0	66	220	40	277,00	1	081470020	

Articolo fornito smontato: deve essere assemblato prima dell'utilizzo in accordo al manuale istruzioni.

8147P

pinze di ancoraggio per paranchi manuali

Idonei per travi strutturali come ad esempio travi INP, IPB, IPE, HEA, HEB

CE

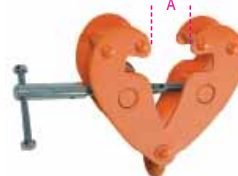

Dati tecnici:

- Coefficiente di sicurezza: 4
- Piastra di identificazione seriale

Certificati disponibili:

- Certificato del Fabbricante
- Dichiarazione di Conformità CE
- Rapporto di Prova tipo 2.2 UNI EN10204
- Specifica Prodotto

WLL	t	A min	A max	€		
		mm	mm			
1,0	90	180	112,00	1	081470210	
2,0	90	190	135,50	1	081470220	
3,0	85	280	229,00	1	081470230	
5,0	85	280	334,00	1	081470250	

 **Robur**

 **Robur**

8148

argano manuale a fune passante, corpo in lega di alluminio completo di leva di azionamento, fune e gancio

Leggero e portatile, l'argano manuale a fune Robur è conforme alla norma EN 13157, è realizzato con materiali di alta qualità ed è idoneo per il sollevamento, il traino, il tensionamento e il fissaggio di carichi in tutte le direzioni tramite la leva di azionamento.

Generalmente utilizzato mediante un collegamento ad un punto di ancoraggio fisso, permette un'elevata precisione nel posizionamento del carico e garantisce un funzionamento sicuro in qualsiasi direzione: orizzontale, verticale o inclinato. Il suo design compatto e maneggevole ne agevola l'installazione e l'utilizzo.

L'argano manuale Robur consente l'utilizzo di funi senza limiti di lunghezza e, previa verifica della struttura di sostegno, è possibile aumentarne la portata di un fattore di 2, 3, 4 o più, utilizzando rulli di rinvio e ganci con bozzello in accordo alla norma di riferimento.

CE

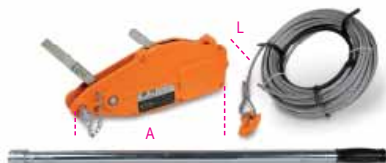

EN 13157

- Coefficiente di sicurezza 4:1
- Piastra di identificazione seriale

Certificati disponibili:

- Certificato del Fabbricante
- Dichiarazione di Conformità CE
- Rapporto di Prova tipo 2.2 UNI EN10204
- Manuale d'uso e manutenzione

WLL	L	A	ø f	€		
t	m	mm	mm			
0,8	20	426	8,3	379,00	1	081480008
1,6	20	545	11	594,00	1	081480016
3,2	20	660	16	978,00	1	081480032

0,8	30	426	8,3	422,00	1	081480108
1,6	30	545	11	660,00	1	081480116
3,2	30	660	16	1.099,00	1	081480132

0,8	50	426	8,3	510,00	1	081480308
1,6	50	545	11	764,00	1	081480316
3,2	50	660	16	1.330,00	1	081480332

8148F

funi a trefoli in acciaio zincato avvolta su crociera con gancio alta resistenza

CE



WLL	L	ØF	€		
t	m	mm			
0,8	20	8,3	103,00	1	081480520
1,6	20	11	163,00	1	081480521
3,2	20	16	317,00	1	081480523

0,8	30	8,3	146,00	1	081480530
1,6	30	11	228,50	1	081480531
3,2	30	16	438,00	1	081480533

0,8	50	8,3	233,50	1	081480550
1,6	50	11	333,00	1	081480551
3,2	50	16	670,00	1	081480553

8120

catene tipo Genovese per collegamenti statici, zincate



DATI TECNICI

- coefficiente di sicurezza: 4

CERTIFICATI DISPONIBILI

- Specifica Prodotto
- Rapporto di Prova tipo 2.2 UNI EN10204

Ø mm	nr	WFL	kg	m	€		
1,5	10	8	150		197,00	1	081200015
1,6	12	15	150		205,00	1	081200016
2,2	14	25	75		120,00	1	081200022
2,7	16	40	75		148,50	1	081200027
3,0	17	55	75		164,00	1	081200030
3,4	18	100	60		167,00	1	081200034
3,8	19	110	50		161,50	1	081200038
4,4	20	200	40		149,50	1	081200044
4,8	21	250	30		142,50	1	081200048
5,5	22	300	25		142,50	1	081200055
5,8	23	310	25		161,50	1	081200058
6,5	24	400	25		183,00	1	081200065
7,0	25	450	25		223,00	1	081200070
7,5	26	550	20		199,00	1	081200075
* 8,0	27	600	25		288,00	1	081200080
* 9,0	28	800	25		362,00	1	081200090
* 10,0	30	1000	20		366,00	1	081200100
* 12,0	32	1400	15		388,00	1	081200120

Attenzione: prodotto NON destinato al sollevamento (*) confezionati in MATASSE

8120B

catene tipo Genovese per collegamenti statici, zincate



DATI TECNICI

- coefficiente di sicurezza: 4

CERTIFICATI DISPONIBILI

- Specifica Prodotto
- Rapporto di Prova tipo 2.2 UNI EN10204

Ø mm	nr	WFL	kg	m	€		
1,5	10	8	200		245,00	1	081200315
1,6	12	15	200		259,00	1	081200316
2,2	14	25	100		153,00	1	081200322
2,7	16	40	100		196,00	1	081200327
3,0	17	55	75		163,50	1	081200330
3,4	18	100	100		260,00	1	081200334
3,8	19	110	75		230,50	1	081200338
4,4	20	200	50		178,50	1	081200344
4,8	21	250	50		230,50	1	081200348
5,5	22	300	40		221,00	1	081200355
5,8	23	310	30		189,00	1	081200358
6,5	24	400	30		215,50	1	081200365
7,0	25	450	25		217,50	1	081200370
7,5	26	550	25		240,00	1	081200375
8,0	27	600	15		185,00	1	081200380
9,0	28	800	15		218,50	1	081200390
10,0	30	1000	10		179,00	1	081200400
12,0	32	1400	8		207,00	1	081200420

Attenzione: prodotto NON destinato al sollevamento

8121MZC

catene tipo Genovese per collegamenti statici zincate a caldo



CERTIFICATI DISPONIBILI

- Specifica Prodotto
- Rapporto di Prova tipo 2.2 UNI EN10204

Ø mm	nr	WFL	kg	m	€		
6,0	23	310	50		353,00	1	081210306
8,0	27	600	50		603,00	1	081210308
10,0	30	1000	50		954,00	1	081210310
12,0	32	1400	50		1.370,00	1	081210312
14,0	34	1800	50		1.925,00	1	081210314

8120D

catene calibrate DIN766 zincatura elettrolitica

a richiesta può essere fornita nella lunghezza desiderata (>30m)



Dati tecnici:

- Coefficiente di sicurezza: 4

Certificati disponibili:

- Specifica Prodotto
- Rapporto di Prova tipo 2.2 UNI EN10204

Ø mm	P	WFL	kg	m	€		
4	16	200	30		123,00	1	081200640
5	18,5	320	30		173,50	1	081200650
6	18,5	400	30		263,00	1	081200660
7	22	630	30		316,00	1	081200670
8	24	800	30		418,00	1	081200680
10	28	1250	30		638,00	1	081200700

catene calibrate DIN766, zincatura A CALDO

Ø mm	P	WFL	kg	m	€		
4	16	200	30		153,00	1	081200840
5	18,5	320	30		209,50	1	081200850
6	18,5	400	30		311,00	1	081200860
7	22	630	30		365,00	1	081200870
8	24	800	30		485,00	1	081200880
10	28	1250	30		734,00	1	081200900

8129

catena di delimitazione in metallo zincata e verniciata bianca e rossa



Ø mm	m	€	📦	🚚
5	30	260,00	1	081290050

Attenzione: prodotto NON destinato al sollevamento o ancoraggio

8130

catene antifurto in acciaio legato cementate e bonificate zincate



CERTIFICATI DISPONIBILI
• Rapporto di Prova tipo 2.2 UNI EN10204

Ø mm	L mm	€	📦	🚚
6	800	15,70	1	081300068
8	1000	34,00	1	081300081
8	1200	38,50	1	081300082
10	1500	59,00	1	081300105

8074

moschettoni zincati



DIN 5299 tipo C

DATI TECNICI
• coefficiente di sicurezza: 4
CERTIFICATI DISPONIBILI
• Specifica Prodotto
• Rapporto di Prova tipo 2.2 UNI EN10204

DxL mm	A mm	WFL kg	€	📦	🚚
* 4x40	6	20	0,64	100	080740040
5x50	7	30	0,65	100	080740050
6x60	8	40	0,72	100	080740060
7x70	9	60	0,92	50	080740070
8x80	11	75	1,11	50	080740080
9x90	12	100	1,51	25	080740090
10x100	13	120	2,04	25	080740100
11x120	16	140	2,76	20	080740101
12x140	22	140	3,85	15	080740102
13x160	24	200	5,30	10	080740103
* 14x180	32	250	11,10	5	080740104

*Misure non contemplate nella norma

confezioni speciali



DxL mm	A mm	📦	€	🚚
6x60	8	50	40,50	1 080740760
7x70	9	25	26,00	1 080740770
8x80	11	25	31,00	1 080740780
9x90	12	15	25,50	1 080740790
10x100	13	15	34,50	1 080740800
11x120	16	10	31,00	1 080740801
12x140	22	10	43,50	1 080740802

8074A

moschettoni con anello zincati

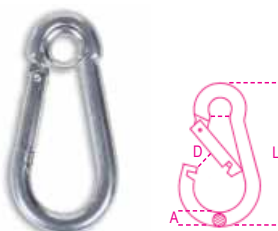

DIN 5299 tipo A

DATI TECNICI
• coefficiente di sicurezza: 4
CERTIFICATI DISPONIBILI
• Specifica Prodotto
• Rapporto di Prova tipo 2.2 UNI EN10204

øAxL mm	D mm	WFL kg	€	📦	🚚
5x50	7,4	30	0,88	50	080740405
6x60	8,7	40	1,01	50	080740406
8x80	10,5	75	1,38	25	080740408
10x100	13,3	120	2,43	10	080740410

8074G

moschettoni con ghiera zincati

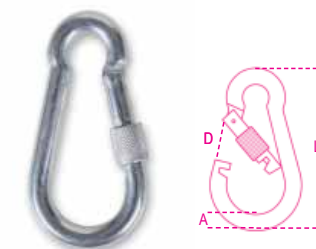

DATI TECNICI
• coefficiente di sicurezza: 4
CERTIFICATI DISPONIBILI
• Specifica Prodotto
• Rapporto di Prova tipo 2.2 UNI EN10204

øAxL mm	D mm	WFL kg	€	📦	🚚
5x50	7,5	30	0,99	50	080740305
6x60	8,5	40	1,13	50	080740306
8x80	10,3	75	1,51	25	080740308
10x100	10,6	120	2,55	10	080740310

8080

maglie rapide di giunzione zincate



DATI TECNICI
• coefficiente di sicurezza: 4
CERTIFICATI DISPONIBILI
• Specifica Prodotto
• Rapporto di Prova tipo 2.2 UNI EN10204

DxL mm	A mm	WFL kg	€	📦	🚚
3,5x36	5	20	0,52	100	080800003
4x40	6	30	0,56	100	080800004
5x49	6	50	0,68	100	080800005
6x57	8	60	0,85	100	080800006
7x66	8	100	1,11	50	080800007
8x74	11	140	1,32	50	080800008
9x80	11	160	1,90	25	080800009
10x89	11	220	2,23	25	080800010
12x105	15	300	3,85	20	080800012
14x122	16,5	400	8,30	3	080800014

8080FM

false maglie, zincate

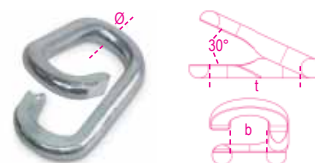

Dati tecnici:
• Coefficiente di sicurezza: 4
Certificati disponibili:
• Specifica Prodotto
• Rapporto di Prova tipo 2.2 UNI EN10204

M	ød mm	b mm	t mm	€	📦	🚚
4	3,8	8,6	21,5	0,41	100	080800204
5	4,7	11,1	25,8	0,67	50	080800205
6	5,3	13,8	32,0	1,30	30	080800206
7	6,5	16,8	37,0	1,55	10	080800207
8	8,0	18,0	38,0	2,28	10	080800208

8082

Anelli acciaio zincato

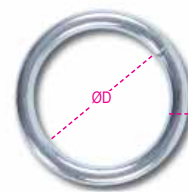

CERTIFICATI DISPONIBILI
• Rapporto di Prova tipo 2.2 UNI EN10204

Ø mm	ØD mm	WFL kg	€	📦	🚚
4	20	75	0,40	50	080820004
5	30	125	0,52	20	080820005
6	40	185	0,85	10	080820006
7	50	265	1,32	5	080820007
8	60	350	1,77	5	080820008

8083
ganci a "S"
acciaio zincato



CERTIFICATI DISPONIBILI
• Rapporto di Prova tipo 2.2 UNI EN10204

Ø mm	L mm	WFL kg	€		
3	33	4	0,08	100	080830003
4	40	5	0,12	60	080830004
5	47	12	0,22	50	080830005
6	59	18	0,41	30	080830006
8	79	33	1,02	10	080830008

8114
tornichetti girevoli
a un occhio allungato
tipo Marche, zincati

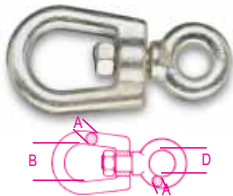

DATI TECNICI
• coefficiente di sicurezza: 4
• codice di identificazione
ANALISI DI LABORATORIO
• test di trazione
CERTIFICATI DISPONIBILI
• Specifica Prodotto
• Rapporto di Prova tipo 2.2 UNI EN10204
• Certificato di Controllo tipo 3.1 UNI EN10204

A mm	B mm	D mm	WFL kg	€		
8	30	16	250	4,20	10	081140008
10	38	18	300	7,75	10	081140010
12	42	20	650	11,20	5	081140012
14	48	22	820	17,40	5	081140014
16	57	24	1000	23,80	3	081140016
18	64	26	1600	28,50	3	081140018
20	72	30	2000	40,00	1	081140020
22	80	34	2500	56,00	1	081140022

8116
tornichetti girevoli
a due occhi allungati
tipo Sicilia, zincati

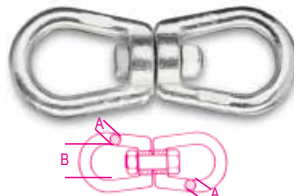

DATI TECNICI
• coefficiente di sicurezza: 4
• codice di identificazione
ANALISI DI LABORATORIO
• test di trazione
CERTIFICATI DISPONIBILI
• Specifica Prodotto
• Rapporto di Prova tipo 2.2 UNI EN10204
• Certificato di Controllo tipo 3.1 UNI EN10204

A mm	B mm	WFL kg	€		
6	23	140	4,50	10	081160006
8	30	250	5,60	10	081160008
10	38	300	10,20	5	081160010
12	42	650	16,80	5	081160012
14	48	820	25,00	3	081160014
16	57	1000	31,50	3	081160016
18	64	1600	38,00	1	081160018
20	72	2000	54,00	1	081160020
22	80	2500	83,50	1	081160022

8317SZ
morsetti simplex
zincati



CERTIFICATI DISPONIBILI
• Rapporto di Prova tipo 2.2 UNI EN10204

Ø mm	L mm	L1 mm	€		
2	15	14	0,25	100	083170102
3	18	16	0,26	100	083170103
4	20	19	0,37	100	083170104
5	24	23	0,42	50	083170105
6	30	27	0,50	30	083170106
8	36	34	0,96	20	083170108
10	42	37	1,44	10	083170110

8317DZ
morsetti duplex
zincati



CERTIFICATI DISPONIBILI
• Rapporto di Prova tipo 2.2 UNI EN10204

Ø mm	L mm	L1 mm	€		
2	30	14	0,33	50	083170002
3	35	15	0,45	50	083170003
4	40	18	0,52	50	083170004
5	50	21	0,66	25	083170005
6	60	25	0,88	20	083170006
8	76	33	1,90	10	083170008
10	95	37	2,87	10	083170010

8381SL
collari per sostegno tubazioni
serie leggera
zincati

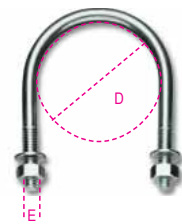

CERTIFICATI DISPONIBILI
• Specifica Prodotto
• Rapporto di Prova tipo 2.2 UNI EN10204

D mm	D gas	E mm	€		
11	1/8"	M6	0,52	100	083810201
14	1/4"	M6	0,56	100	083810202
18	3/8"	M6	0,56	100	083810203
22	1/2"	M6	0,64	100	083810204
27	3/4"	M6	0,64	100	083810205
34	1"	M6	0,70	100	083810206
43	1 1/4"	M6	0,70	100	083810207
49	1 1/2"	M8	1,25	50	083810208
61	2"	M8	1,32	50	083810209
77	2 1/2"	M8	1,57	25	083810210
89	3"	M8	1,68	25	083810211
102	3 1/2"	M8	1,90	25	083810212
115	4"	M8	2,10	25	083810213
140	5"	M8	4,60	25	083810215
168	6"	M10	5,00	25	083810218
220	8"	M10	10,20	10	083810220

8381SP
collari per sostegno tubazioni
serie pesante
zincati

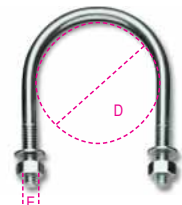

CERTIFICATI DISPONIBILI
• Specifica Prodotto
• Rapporto di Prova tipo 2.2 UNI EN10204

D mm	D gas	E mm	€		
22	1/2"	M8	0,92	100	083810301
27	3/4"	M8	1,00	100	083810302
34	1"	M8	1,08	100	083810303
43	1 1/4"	M8	1,17	100	083810304
49	1 1/2"	M10	1,98	25	083810305
61	2"	M10	2,16	25	083810306
77	2 1/2"	M10	2,49	25	083810307
89	3"	M10	2,62	25	083810308
102	3 1/2"	M12	4,20	25	083810309
115	4"	M12	4,60	15	083810310
140	5"	M12	7,15	15	083810312
168	6"	M16	12,00	15	083810315
220	8"	M16	21,20	10	083810320
274	10"	M16	22,30	1	083810374
274	10"	M20	32,00	1	083810375
324	12"	M20	68,00	1	083810386
408	16"	M24	100,00	1	083810508

Robur

Robur

8383C
collari quadri
zincati a caldo
Dadi flangiati

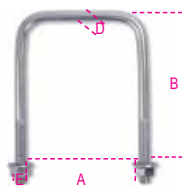

CERTIFICATI DISPONIBILI
• Specifica Prodotto
• Rapporto di Prova tipo 2.2 UNI EN10204

A mm	E mm	B mm	D mm	€		
70	M10	110	8,55	2,10	130	083830070
80	M10	120	8,55	2,43	110	083830080
90	M10	130	8,55	2,62	100	083830090
100	M10	155	8,55	3,15	90	083830100
120	M10	175	8,55	3,65	70	083830120

8383P
piastre per collari quadri
zincate a caldo

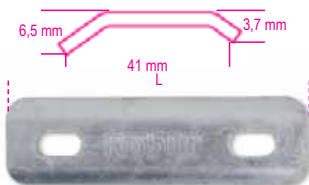

CERTIFICATI DISPONIBILI
• Specifica Prodotto
• Rapporto di Prova tipo 2.2 UNI EN10204

	L mm	€		
8383P 150 8383C/70-80 /90-100	150	2,62	150	083830214
8383P 170 8383C/100-120	170	3,15	120	083830217

8515Z
tirafili per agricoltura
zincati

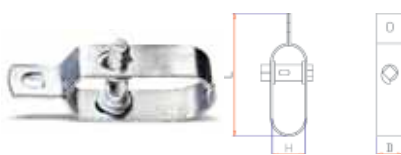

D mm	H mm	L mm	€		
20	25	93	1,38	50	085150002
24,5	30	100	1,90	50	085150003

8515V
tendifili per agricoltura
verniciati



D mm	H mm	L mm	€		
20	25	93	1,83	50	085150102
24,5	30	100	2,31	50	085150103

8515CH
chiavette per tendifili
zincate



L mm	O A mm	O B mm	€		
90	8	7,5	0,66	20	085150901

8531
grilli tipo pesca
zincati a caldo



CERTIFICATI DISPONIBILI
• Rapporto di Prova tipo 2.2 UNI EN10204

Ø mm	D mm	WFL kg	€		
20	18	1600	18,90	1	085310018
22	20	2500	27,50	1	085310020

8532
grilli tipo pesca con perno quadro,
verniciati neri



CERTIFICATI DISPONIBILI
• Rapporto di Prova tipo 2.2 UNI EN10204

Ø mm	D mm	WFL kg	€		
20	20	1600	9,30	1	085320020
22	22	2500	14,20	1	085320022

8535
uncini tipo pesca
zincati

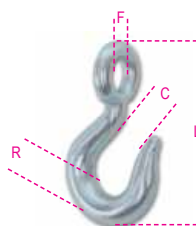

CERTIFICATI DISPONIBILI
• Rapporto di Prova tipo 2.2 UNI EN10204

R mm	C mm	F mm	L mm	€		
26	27,5	34	156	21,20	1	085350006
30	36,5	40	185	29,00	1	085350007

8050 D1÷D45
kit sicure e ricambi per ganci di sollevamento



	€		
8050D1 8064S-8065SC/800-8055S/1250	8,20	1	080500945
8050D2 8064S-8065SC/1000 8062/1500-8055S/1600	9,55	1	080500946
8050D3 8064S-8065SC/1600-2000 8055S/2500-3200	10,30	1	080500947
8050D4 8064S-8065SC/3200-8055S/5400	17,10	1	080500948
8050D5 8064S-8065SC/5000-8055S/8000	19,80	1	080500949
8050D6 8064S/7500-8055S/11500	31,50	1	080500950
8050D11 8062/2000	16,30	1	080500955
8050D12 8062/3000	18,00	1	080500956
8050D13 8062/5000	32,50	1	080500957
8050D22 8064S/10000 8055S/16000	43,00	1	080500966
8050D23 8055S/22000	59,50	1	080500967
8050D24 8051S/250	0,75	1	080500969
8050D25 8051S/500	0,89	1	080500970
8050D30 8061F/8000	24,00	1	080500975
8050D32 8060/8000	33,00	1	080500977
8050D 33 8052/800	3,30	1	080500978
8050D 34 8052/1120	3,70	1	080500979
8050D 35 8052/2000	4,55	1	080500980
8050D 36 8052/3150	4,95	1	080500981
8050D 37 8052/4000	5,85	1	080500982
8050D38 8060R/1120	2,15	1	080500983
8050D53 8060R/1500	2,92	1	080500994
8050D39 8060R/2000	2,92	1	080500984
8050D40 8060R/3150	5,10	1	080500985
8050D41 8060R/5300	7,85	1	080500986
8050D42 8063/800	0,75	1	080500987
8050D43 8063/1120	1,07	1	080500988
8050D44 8063/2000	1,39	1	080500989
8050D45 8063/3150	1,71	1	080500990



8050D46 8061R/1120	2,23	1	080500991
8050D47 8061R/2000	2,23	1	080500992
8050D48 8061R/3150	3,05	1	080500993
8050D54 8061R/5300	3,05	1	080500995



8050D49 8057R - 8058R - 8063SL /1120	6,15	1	080500849
8050D50 8057R - 8058R - 8063SL /2000	6,70	1	080500850
8050D51 8057R - 8058R - 8063SL /3150	7,30	1	080500851
8050D52 8057R - 8058R - 8063SL /5300	16,40	1	080500852

8058R/PS

kit perni e spine per ganci 8058R-8061R



8058R/PS	∅ mm	€	Icona	Icona
1,12	6	7,15	1	080580512
2,0	7-8	8,20	1	080580520
3,15	10	16,40	1	080580532
5,3	13	28,00	1	080580553

8060R/PS

kit perni e spine per ganci 8060R



8060R/PS	∅ mm	€	Icona	Icona
1,12	6	7,15	1	080600511
1,5	7	8,20	1	080600515
2,0	8	8,20	1	080600520
3,15	10	16,40	1	080600532
5,3	13	28,00	1	080600553

8135/KLA1

kit leve di azionamento
per pinze di sollevamento 8135



8135	t	€	Icona	Icona
0,75		16,10	1	081350605
1,0		20,00	1	081350610
2,0		23,10	1	081350615
3,0		28,00	1	081350620
5,0		43,00	1	081350625

La responsabilità della riparazione è a carico del
soggetto che la effettua.

8135/KM0

kit molle per pinze di sollevamento 8135



8135	t	€	Icona	Icona
0,75		7,15	1	081350655
1,0		10,40	1	081350660
2,0		13,60	1	081350665
3,0		17,50	1	081350670
5,0		26,00	1	081350675

La responsabilità della riparazione è a carico del
soggetto che la effettua.

8143/RKL

kit linguette gancio superiore e inferiore
per paranchi manuali a catena 8143



8143	WLL t	€	Icona	Icona
0,5		1,45	1	081430500
1,0		1,67	1	081430501
2,0		2,52	1	081430502
3,0		2,95	1	081430503
5,0		3,45	1	081430504

8143/RPC

kit perni blocco catena su gancio
per paranchi manuali 8143



8143	WLL t	€	Icona	Icona
0,5		1,74	1	081430510
1,0		2,38	1	081430511
2,0		2,57	1	081430512
3,0		4,20	1	081430513
5,0		4,55	1	081430514

8143/RPF

kit perni fine corsa
per paranchi a catena 8143



8143	WLL t	€	Icona	Icona
0,5		0,79	1	081430520
1,0		0,84	1	081430521
2,0		1,18	1	081430522
3,0		0,93	1	081430523
5,0		1,45	1	081430524

8143/RKCI

kit corpi ganci inferiori
per paranchi a catena 8143



8143	WLL t	€	Icona	Icona
0,5		11,20	1	081430560
1,0		14,70	1	081430561
2,0		27,50	1	081430562
3,0		90,00	1	081430563
5,0		124,00	1	081430564

8146/RK

kit sicure, perni, finecorsa
per paranchi manuali a LEVA 8146C



8146C	WLL t	€	Icona	Icona
0,25		5,60	1	081460902

8146/RKL

kit linguette gancio superiore e inferiore
per paranchi manuali a leva 8146



8146	WLL t	€	Icona	Icona
0,75		1,67	1	081460500
1,5		1,92	1	081460501
3,0		2,95	1	081460502
6,0		3,35	1	081460503

8146/RPC

kit perni blocco catena su gancio
per paranchi manuali a leva 8146



8146	WLL t	€	Icona	Icona
0,75		1,74	1	081460510
1,5		2,57	1	081460511
3,0		2,71	1	081460512
6,0		2,71	1	081460513

8146/RKFC

kit finecorsa
per paranchi manuali a leva 8146



8146	WLL t	€	Icona	Icona
0,75		4,60	1	081460520
1,5		5,90	1	081460521
3,0		6,30	1	081460522
6,0		7,40	1	081460523

 **Robur**

 **Robur**



8146/RKCI

kit corpi ganci inferiori
per paranchi manuali a leva 8146



8146 WLL t	€		
0,75	12,80	1	081460560
1,5	27,50	1	081460561
3,0	90,00	1	081460562
6,0	170,00	1	081460563

8148/RA

crociera per fune argani manuali 8148



8148 t	€		
0,8	20,40	1	081480900
1,6	27,50	1	081480901
3,2	35,50	1	081480902

8148/RKS

set 3 spine di sicurezza
da sovraccarico
per argani manuali 8148



8148 t	€		
0,8	3,75	1	081480903
1,6 - 3,2	4,70	1	081480904

8148/RKCM

set 2 cappucci manico
per argani manuali 8148



8148/RKCM	€		
	1,71	1	081480905

8148/RKCL

set 2 cappucci leva
per argani manuali 8148



8148/RKCL	€		
	1,82	1	081480906

8148/RP

perni di ancoraggio
per argani manuali 8148



8148 t	€		
0,8	15,60	1	081480907
1,6	21,00	1	081480908
3,2	26,50	1	081480909

8148/RKG

set 2 guaine di protezione
per argani manuali 8148



8148 t	€		
0,8	16,10	1	081480910
1,6	18,40	1	081480911
3,2	19,40	1	081480912



8149

Catene per paranchi,
acciaio legato ad alta resistenza
verniciata nera

CE

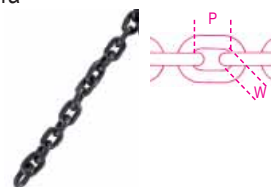

EN 818-7

DATI TECNICI

- coefficiente di sicurezza: 4
- trattamento termico: bonifica
- codice lotto di fabbricazione
- ANALISI DI LABORATORIO
- analisi chimica
- analisi metallografica
- test di trazione
- CERTIFICATI DISPONIBILI
- Specifica Prodotto
- Rapporto di Prova tipo 2.2 EN10204
- Certificato di Collaudo tipo 3.1 EN10204
- Dichiarazione di Conformità CE

Ø mm	WLL Kg	P mm	W min	€/m		
4	500	12	4,8	15,40	1	081490012
5	800	15	6,0	19,00	1	081490015
6	1100	18	7,2	21,30	1	081490018
6,3	1200	19	7,6	23,60	1	081490019
8	2000	24	9,6	32,00	1	081490024
10	3200	30	12	49,50	1	081490030

* ATTENZIONE: il prodotto viene consegnato in un unico spezzone di catena, salvo diversa indicazione in fase d'ordine!

8149CM

catene a mano per paranchi 8143



Ø mm	B mm	t mm	€/m		
4,8	8,2	22,2	4,90	1	081490901

*Viene consegnato un unico spezzone di catena aperto che deve essere chiuso dall'utilizzatore alla lunghezza desiderata (salvo diversa indicazione in fase d'ordine)

8149CM/RA

anello saldato di ricambio
catena a mano per paranchi 8143



L m	Ø mm	B mm	€		
3	4,8	8,2	62,50	1	081490903
6	4,8	8,2	94,50	1	081490906

*Anello chiuso saldato. Leggere attentamente il manuale per la sostituzione della catena.



A differenza dell'inox generico (AISI 304), l'acciaio AISI 316 da noi selezionato offre una maggiore resistenza agli agenti atmosferici, alla corrosione salina e da sali e acidi organici. L'acciaio inossidabile AISI 316 contiene elevate quantità di:

- **Cromo** (forma una pellicola superficiale che protegge il materiale sottostante dall'ossidazione)
- **Molibdeno** (aumenta la resistenza alla corrosione dei cloruri, come acqua marina o disgelanti)
- **Nichel** (consente di mantenere la struttura dell'acciaio stabile nel tempo)

Il ridotto contenuto di carbonio rende inoltre questo acciaio più resistente alla corrosione intergranulare, un particolare tipo di corrosione difficile da rilevare sulla superficie dell'accessorio e che può innescare, in ambienti corrosivi, rotture improvvise.

Altre caratteristiche che distinguono l'acciaio AISI 316 sono la facilità di ripulitura, l'ottimo coefficiente igienico, le caratteristiche amagnetiche e le performance meccaniche a basse temperature.

Il fattore principale di affidabilità dei prodotti **Robur** Inox resta senza dubbio la qualità omogenea e costante nel tempo, che assicura gli stessi livelli di performance per tutti i lotti di produzione, ieri oggi e domani.

8205

tenditore a due occhi
inox AISI 316

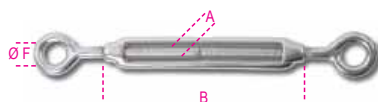

ANALISI DI LABORATORIO

- analisi chimica
- test di trazione
- CERTIFICATI DISPONIBILI**
- Specifica Prodotto
- Rapporto di Prova tipo 2.2 UNI EN10204

A mm	B mm	ØF mm	WFL kg	€		
M4	62	8	75	6,15	10	082050204
M5	72	11	115	7,35	10	082050205
M6	92	12	160	9,75	8	082050206
M8	122	14	300	15,00	8	082050208
M10	150	16	470	22,60	4	082050210
M12	201	18	690	38,50	1	082050212
M14	225	22	940	96,00	1	082050214
M16	244	26	1290	98,00	1	082050216
M20	295	29	2130	141,50	1	082050220
M24	350	33	3000	324,00	1	082050224

confezioni speciali



A mm	B mm	€		
M4	62	34,50	1	082050704
M5	72	41,50	1	082050705
M6	92	44,00	1	082050706
M8	122	67,50	1	082050708
M10	150	51,00	1	082050710

8206

tenditore ad occhio e gancio
inox AISI 316

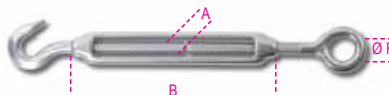

ANALISI DI LABORATORIO

- analisi chimica
- test di trazione
- CERTIFICATI DISPONIBILI**
- Specifica Prodotto
- Rapporto di Prova tipo 2.2 UNI EN10204

A mm	B mm	ØF mm	WFL kg	€		
M5	72	11	25	7,45	10	082060205
M6	92	12	45	10,30	5	082060206
M8	122	14	95	15,70	5	082060208
M10	150	16	140	24,00	1	082060210
M12	201	18	300	40,00	1	082060212
M14	225	22	420	96,50	1	082060214
M16	244	26	570	98,50	1	082060216
M20	295	29	875	144,00	1	082060220

8207

tenditore a due ganci
inox AISI 316

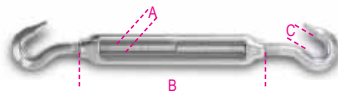

ANALISI DI LABORATORIO

- analisi chimica
- test di trazione
- CERTIFICATI DISPONIBILI**
- Specifica Prodotto
- Rapporto di Prova tipo 2.2 UNI EN10204

A mm	B mm	C mm	WFL kg	€		
M5	72	9	25	7,90	10	082070205
M6	92	9	45	10,40	5	082070206
M8	122	10	95	16,00	5	082070208
M10	150	12	140	24,40	1	082070210
M12	201	14	300	40,50	1	082070212
M14	225	15	420	98,00	1	082070214
M16	244	16	570	101,50	1	082070216
M20	295	19	875	149,00	1	082070220

8209

tenditore a due forcelle
inox AISI 316

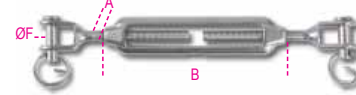

ANALISI DI LABORATORIO

- analisi chimica
- test di trazione
- CERTIFICATI DISPONIBILI**
- Specifica Prodotto
- Rapporto di Prova tipo 2.2 UNI EN10204

A mm	B mm	ØF mm	WFL kg	€		
M5	72	5	115	13,20	5	082090205
M6	92	6	160	15,50	5	082090206
M8	122	8	300	22,30	5	082090208
M10	150	10	470	36,50	1	082090210
M12	201	12	690	59,00	1	082090212
M14	225	14	940	79,50	1	082090214
M16	244	16	1290	120,00	1	082090216
M20	295	20	2130	211,00	1	082090220
M24	350	24	3060	512,00	1	082090224

8210

tenditore a due forcelle con canaula a tubo
inox AISI 316

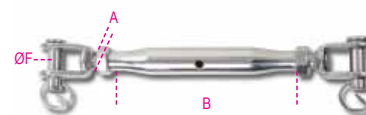

ANALISI DI LABORATORIO

- analisi chimica
- test di trazione
- CERTIFICATI DISPONIBILI**
- Specifica Prodotto
- Rapporto di Prova tipo 2.2 UNI EN10204

A mm	B mm	ØF mm	WFL kg	€		
M5	81	5	115	16,60	3	082100205
M6	92	6	160	20,00	3	082100206
M8	112	8	300	29,00	1	082100208
M10	121	10	470	45,50	1	082100210
M12	150	12	690	75,50	1	082100212
M14	169	14	940	98,00	1	082100214
M16	190	16	1290	145,00	1	082100216
M20	220	20	2130	252,00	1	082100220

8210FTP

tenditori a forcella e terminale a pressare
canaula a tubo
inox Aisi 316

Acciaio con Nichel, Cromo e Molibdeno per una maggiore
resistenza alla corrosione.



ANALISI DI LABORATORIO

- analisi chimica
- test di trazione

CERTIFICATI DISPONIBILI

- Specifica Prodotto
- Rapporto di Prova tipo 2.2 UNI EN10204

Ø mm	A mm	ØD mm	WFL kg	€		
M5	159	2,70	150	18,50	2	082100605
M6	179	3,30	250	21,90	2	082100606
M8	216	4,30	350	30,00	1	082100608
M10	241	5,30	550	46,00	1	082100610
M12	300	6,30	1000	67,00	1	082100612
M14	345	7,30	1350	101,50	1	082100614
M16	383	8,30	1625	147,50	1	082100616
M20	484	10,50	2125	251,00	1	082100620

8201T

canaule a tubo
inox AISI 316



ANALISI DI LABORATORIO

- analisi chimica
- test di trazione

CERTIFICATI DISPONIBILI

- Specifica Prodotto
- Rapporto di Prova tipo 2.2 UNI EN10204

Ø mm	Ø	WFL kg	L mm	€		
M6	1/4	160	95	3,70	5	082010406
M8	5/16	300	105	5,45	5	082010408
M10	3/8	470	125	9,15	3	082010410
M12	1/2	690	150	16,00	3	082010412
M14	9/16	940	165	17,00	1	082010414
M16	5/8	1290	190	29,00	1	082010416
M20	3/4	2130	210	43,50	1	082010420

8210F

forcelle per tenditori
inox AISI 316

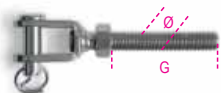

Analisi di laboratorio:

- Analisi chimica
- Test di trazione

Certificati disponibili:

- Specifica Prodotto
- Rapporto di Prova tipo 2.2 UNI EN10204

Ø mm	Ø	G mm	WFL kg	€		
M5	3/16	38,5	115	5,50	4	082100305
M6	1/4	49	160	6,15	4	082100306
M8	5/16	56	300	8,95	4	082100308
M10	3/8	61	470	15,30	2	082100310
M12	1/2	81	690	24,10	2	082100312
M14	9/16	93	940	38,00	2	082100314

filetto sinistrorso

Ø mm	Ø	G mm	WFL kg	€		
M5	3/16	38,5	115	5,50	4	082100405
M6	1/4	49	160	6,15	4	082100406
M8	5/16	56	300	8,95	4	082100408
M10	3/8	61	470	15,30	2	082100410
M12	1/2	81	690	24,10	2	082100412
M14	9/16	93	940	39,00	2	082100414

8248

tiranti ad occhio
INOX 316L
destri



UNI 6058

ANALISI DI LABORATORIO

- analisi chimica
- test di trazione

CERTIFICATI DISPONIBILI

- Specifica Prodotto
- Rapporto di Prova tipo 2.2 UNI EN10204

ØxL mm	F mm	€		
8X120	6	7,15	1	082480008
10x80	8	9,65	1	082480010
10x130	8	12,90	1	082480012
12x95	10	14,60	1	082480016
12x125	10	17,40	1	082480018

8249

viti ad occhio per tasselli
inox AISI 316



ANALISI DI LABORATORIO

- analisi chimica
- test di trazione

CERTIFICATI DISPONIBILI

- Specifica Prodotto
- Rapporto di Prova tipo 2.2 UNI EN10204

A mm	WFL kg	D mm	€		
M5	100	50	2,67	10	082490205
M6	160	55	3,35	10	082490206
M8	300	60	5,40	5	082490208
M10	470	80	9,65	5	082490210
M12	690	120	16,80	2	082490212

8249G

ganci per tasselli
inox AISI 316



ANALISI DI LABORATORIO

- analisi chimica
- test di trazione

CERTIFICATI DISPONIBILI

- Specifica Prodotto
- Rapporto di Prova tipo 2.2 UNI EN10204

A mm	E mm	ØF mm	WFL kg	€		
M5	39	9	25	1,28	5	082490305
M6	43	10,5	45	1,53	5	082490306
M8	57	14,5	95	2,67	3	082490308

8216

morsetti
inox AISI 316

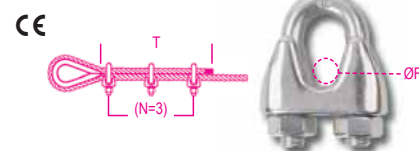

ANALISI DI LABORATORIO

- analisi chimica

test coppia di serraggio

CERTIFICATI DISPONIBILI

- Specifica Prodotto
- Rapporto di Prova tipo 2.2 UNI EN10204
- Certificato di Conformità CE

Ø F mm	"	T	N	€		
2	5/64	80	3	3,10	20	082160202
3	1/8	80	3	3,15	20	082160203
4	5/32	80	3	3,55	20	082160204
5	3/16	110	3	4,00	20	082160205
6	1/4	120	5	4,50	10	082160206
8	5/16	210	5	5,95	10	082160208
10	3/8	240	5	8,30	8	082160210
12-13	1/2	300	5	11,50	5	082160213
16	5/8	335	5	17,00	5	082160216
20	3/4	540	5	21,50	5	082160220
22	7/8	595	7	34,50	3	082160222

confezioni speciali



Ø F mm	"	€		
2	5/64	35,00	1	082160702
3	1/8	35,50	1	082160703
4	5/32	40,00	1	082160704
5	3/16	45,00	1	082160705
6	1/4	25,50	1	082160706
8	5/16	33,50	1	082160708
10	3/8	37,50	1	082160710

confezioni appendibili



Ø F mm		€		
2	4	13,10	1	082169402
3	4	13,20	1	082169403
4	4	14,80	1	082169404
5	2	8,95	1	082169405
6	2	10,10	1	082169406
8	2	13,10	1	082169408
10	2	17,70	1	082169410



8220

radance, tipo pesante
inox AISI 316

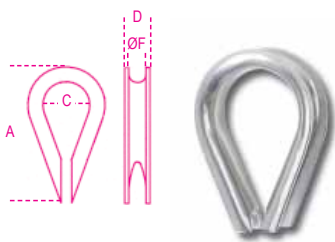

ANALISI DI LABORATORIO

- analisi chimica
- CERTIFICATI DISPONIBILI
- Specifica Prodotto
- Rapporto di Prova tipo 2.2 UNI EN10204

ø F mm	D mm	A mm	C mm	€	📦	🚚
2	4,5	21	7,5	1,01	15	082200202
3	6	24	10	1,11	15	082200203
4	6,6	28	11	1,28	10	082200204
5	8,5	30	13	1,53	10	082200205
6	10	37	15	1,74	10	082200206
8	12,5	51	23	2,74	5	082200208
10	14,6	56	27	3,35	5	082200210
12	18	68	32	4,60	5	082200212
14	19	69	34	5,95	5	082200214
16	22	83	37	6,70	5	082200216
18	23	81	38	7,90	1	082200218
20	27,8	105	45	9,30	1	082200220
22	29,6	112	45	12,10	1	082200222

8225

grilli dritti
inox AISI 316



ANALISI DI LABORATORIO

- analisi chimica
- test di trazione
- CERTIFICATI DISPONIBILI
- Specifica Prodotto
- Rapporto di Prova tipo 2.2 UNI EN10204

ø D mm	A mm	WFL kg	€	📦	🚚
4	5/32	8	3,25	20	082250204
5	3/16	11	3,60	20	082250205
6	1/4	13	3,90	10	082250206
8	5/16	17	6,35	10	082250208
10	3/8	21	9,15	8	082250210
12	1/2	25	15,00	3	082250212
16	5/8	32	33,00	1	082250216
19	3/4	38	55,00	1	082250219
22	7/8	43	85,50	1	082250222
25	1	46	125,00	1	082250225

confezioni speciali



ø D mm	A mm	WFL kg	€	📦	🚚
4	5/32	10	36,50	1	082250704
5	3/16	10	40,50	1	082250705
6	1/4	5	21,90	1	082250706
8	5/16	5	35,50	1	082250708
10	3/8	4	41,00	1	082250710

8227

grilli dritti lunghi
inox AISI 316



ANALISI DI LABORATORIO

- analisi chimica
- test di trazione
- CERTIFICATI DISPONIBILI
- Specifica Prodotto
- Rapporto di Prova tipo 2.2 UNI EN10204

ø D mm	A mm	WFL kg	€	📦	🚚
4	5/32	8	2,74	10	082270204
5	3/16	10	3,15	10	082270205
6	1/4	13,5	4,00	5	082270206
8	5/16	17	6,55	5	082270208
10	3/8	21	10,80	2	082270210
12	1/2	25	17,10	1	082270212

8228

grilli a lira
inox AISI 316

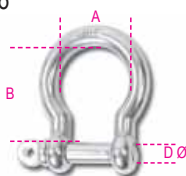

ANALISI DI LABORATORIO

- analisi chimica
- test di trazione
- CERTIFICATI DISPONIBILI
- Specifica Prodotto
- Rapporto di Prova tipo 2.2 UNI EN10204

ø D mm	A mm	B mm	WFL kg	€	📦	🚚
4	13	20	60	2,48	10	082280204
5	17	23	80	2,87	10	082280205
6	20	27	100	3,25	10	082280206
8	28	36	200	5,20	5	082280208
10	36	44	300	8,30	5	082280210
12	41	53	500	13,30	5	082280212
16	54	74	800	29,00	1	082280216
19	66	86	1100	53,00	1	082280219

8240F

golfari per sollevamento inox A4
maschio, FORGIATI

CE



DATI TECNICI

- coefficiente di sicurezza: 6
- codice lotto di fabbricazione

ANALISI DI LABORATORIO

- analisi chimica
- analisi metallografica
- test di trazione
- CERTIFICATI DISPONIBILI
- Specifica Prodotto
- Rapporto di Prova tipo 2.2 UNI EN10204
- Certificato di Controllo tipo 3.1 UNI EN10204
- Dichiarazione di Conformità CE

ø mm	WLL kg	€	📦	🚚	
M6	1,0	120	7,45	4	082400406
* M8	1,25	200	8,30	4	082400408
* M10	1,5	400	14,00	4	082400410
* M12	1,75	600	22,70	4	082400412
* M14	2	1000	36,50	2	082400414
* M16	2	1200	36,50	2	082400416
* M20	2,5	2000	59,00	2	082400420
* M24	3	2700	111,50	2	082400424
* M30	3,5	4000	247,00	1	082400430

(*) Caratteristiche dimensionali DIN 580:2010
WLL incrementato in base a Fascicolo Tecnico Robur
(garantito per accoppiamenti inox-inox)

8240

golfari maschio,
inox AISI 316



ANALISI DI LABORATORIO

- analisi chimica
- test di trazione
- CERTIFICATI DISPONIBILI
- Specifica Prodotto
- Rapporto di Prova tipo 2.2 UNI EN10204

A mm	B mm	ø C mm	WFL kg	€	📦	🚚
M6	41	15	90	2,14	10	082400206
M8	50	20	140	3,20	10	082400208
M10	62	25	230	6,40	5	082400210
M12	74	30	340	10,80	5	082400212

8242F

golfari per sollevamento inox A4
femmina, FORGIATI

CE



DATI TECNICI

- coefficiente di sicurezza: 6
- codice lotto di fabbricazione

ANALISI DI LABORATORIO

- analisi chimica
- analisi metallografica
- test di trazione

CERTIFICATI DISPONIBILI

- Specifica Prodotto
- Rapporto di Prova tipo 2.2 UNI EN10204
- Certificato di Controllo tipo 3.1 UNI EN10204
- Dichiarazione di Conformità CE

ø mm	WLL mm	WLL kg	€		
M6	1,0	120	7,45	4	082420406
* M8	1,25	200	8,30	4	082420408
* M10	1,5	400	14,00	4	082420410
* M12	1,75	600	22,70	4	082420412
* M14	2	1000	36,50	2	082420414
* M16	2	1200	36,50	2	082420416
* M20	2,5	2000	59,00	2	082420420
* M24	3	2700	111,50	2	082420424
* M30	3,5	4000	247,00	1	082420430

(* Caratteristiche dimensionali DIN 582:2010
WLL incrementato in base a Fascicolo Tecnico Robur
(garantito per accoppiamenti inox-inox)

8242

golfari femmina,
inox AISI 316



A mm	B mm	øC mm	WFL kg	€		
M6	27	15	90	2,14	10	082420206
M8	36	20	140	3,20	10	082420208
M10	45	25	230	6,40	5	082420210
M12	55	30	340	10,80	5	082420212

8274

moschettoni
inox AISI 316

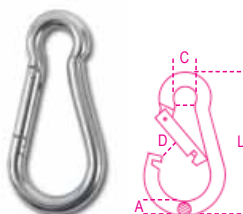

ANALISI DI LABORATORIO

- analisi chimica
 - test di trazione
- CERTIFICATI DISPONIBILI
- Specifica Prodotto
 - Rapporto di Prova tipo 2.2 UNI EN10204

ø A x L mm	ø C mm	D mm	WFL kg	€		
4,5x40	6,5	6	20	2,92	20	082740204
5x50	7	6,5	30	2,92	20	082740205
6x60	8,5	7,5	40	3,10	10	082740206
7x70	10	9	60	3,70	10	082740207
8x80	12	10	75	4,95	10	082740208
9x90	12,5	10,5	100	6,80	10	082740209
10x100	15	13	120	8,45	8	082740210
11x120	19	18	140	12,10	1	082740211
12x140	22	21	140	16,50	1	082740212
13x160	22	26	200	20,70	1	082740213

confezioni speciali



ø A x L mm	ø C mm	WFL kg	€		
4,5x40	6,5	10	33,00	1	082740704
5x50	7	10	33,00	1	082740705
6x60	8,5	5	17,40	1	082740706
7x70	10	5	20,80	1	082740707
8x80	12	5	28,00	1	082740708
9x90	12,5	5	38,00	1	082740709
10x100	15	4	38,00	1	082740710

8274A

moschettoni con anello
inox AISI 316

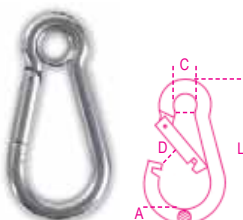

ANALISI DI LABORATORIO

- analisi chimica
 - test di trazione
- CERTIFICATI DISPONIBILI
- Specifica Prodotto
 - Rapporto di Prova tipo 2.2 UNI EN10204

ø A x L mm	ø C mm	D mm	WFL kg	€		
5x50	6,5	7	30	2,87	10	082740405
6x60	7,5	7,5	40	3,45	5	082740406
8x80	9,5	10	75	5,70	5	082740408

8274G

moschettoni con ghiera
inox AISI 316

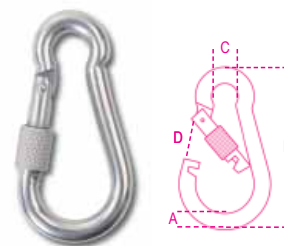

ANALISI DI LABORATORIO

- analisi chimica
 - test di trazione
- CERTIFICATI DISPONIBILI
- Specifica Prodotto
 - Rapporto di Prova tipo 2.2 UNI EN10204

ø A x L mm	ø C mm	D mm	WFL kg	€		
6x60	8,5	6,5	40	3,80	5	082740306
8x80	12	8,5	75	6,85	5	082740308
10x100	15	12	120	13,10	3	082740310

8276

moschettoni asimmetrici
inox AISI 316

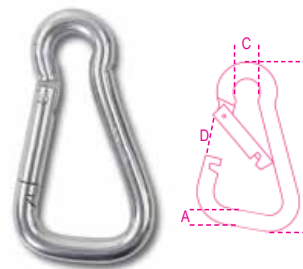

ANALISI DI LABORATORIO

- analisi chimica
 - test di trazione
- CERTIFICATI DISPONIBILI
- Specifica Prodotto
 - Rapporto di Prova tipo 2.2 UNI EN10204

ø A x L mm	ø C mm	D mm	WFL kg	€		
6x60	8,5	10	40	3,45	5	082760206
8x80	12	14	75	5,95	5	082760208
10x100	15	18	120	10,50	3	082760210

Robur

Robur

8276G

moschettoni asimmetrici con ghiera
inox AISI 316

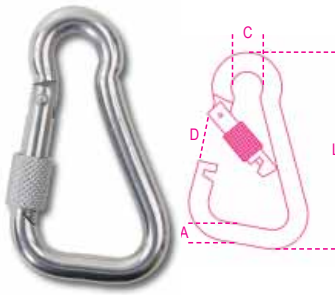

ANALISI DI LABORATORIO

- analisi chimica
 - test di trazione
- CERTIFICATI DISPONIBILI**
- Specifica Prodotto
 - Rapporto di Prova tipo 2.2 UNI EN10204

ø A x L	ø C	D	WFL	€		
mm	mm	mm	kg			
6x60	8,5	9	40	4,40	3	082760306
8x80	12	12,5	75	7,90	3	082760308
10x100	15	16	120	14,40	3	082760310

8278

moschettoni trapezoidali
inox AISI 316

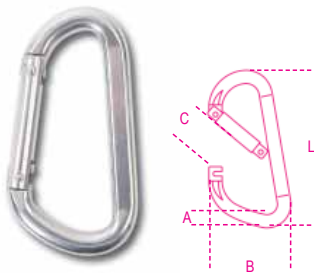

ANALISI DI LABORATORIO

- analisi chimica
 - test di trazione
- CERTIFICATI DISPONIBILI**
- Specifica Prodotto
 - Rapporto di Prova tipo 2.2 UNI EN10204

ø A x L	B	C	WFL	€		
mm	mm	mm	kg			
8x80	45	14	75	13,30	3	082780208
10x100	55	16	120	20,70	3	082780210

Robur

8280

maglie di giunzione
inox AISI 316

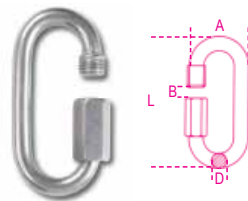

ANALISI DI LABORATORIO

- analisi chimica
 - test di trazione
- CERTIFICATI DISPONIBILI**
- Specifica Prodotto
 - Rapporto di Prova tipo 2.2 UNI EN10204

ø D x L	A	B	WFL	€		
mm	mm	mm	kg			
3,5x35	17	5	20	3,40	10	082800203
4x40	19	6	30	3,60	10	082800204
5x50	23	7	50	4,40	5	082800205
6x60	26	8	60	5,20	5	082800206
7x70	30	9	100	5,95	5	082800207
8x80	33	10	140	8,40	2	082800208
10x90	40	12	220	13,70	2	082800210
12x100	47	14	300	20,70	1	082800212

8250

moschettoni a gancio con sicura
inox AISI 316



ANALISI DI LABORATORIO

- analisi chimica
 - test di trazione
- CERTIFICATI DISPONIBILI**
- Specifica Prodotto
 - Rapporto di Prova tipo 2.2 UNI EN10204

L	A	ø B	WFL	€		
mm	mm	mm	kg			
50	25	8	40	4,25	5	082500205
70	31	12,5	90	6,50	5	082500207
100	47	20	190	10,50	2	082500210

8264

moschettoni a girello
inox AISI 316

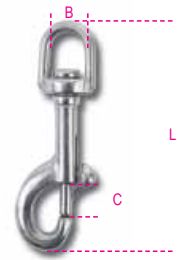

ANALISI DI LABORATORIO

- analisi chimica
 - test di trazione
- CERTIFICATI DISPONIBILI**
- Specifica Prodotto
 - Rapporto di Prova tipo 2.2 UNI EN10204

B	L	C	WFL	€		
mm	mm	mm	kg			
12	88	12	60	11,40	5	082640212
16	90	12	60	11,80	5	082640216
19	93	12	60	11,90	2	082640219

8267

moschettoni a gancio con girello e sicura
inox AISI 316



ANALISI DI LABORATORIO

- analisi chimica
 - test di trazione
- CERTIFICATI DISPONIBILI**
- Specifica Prodotto
 - Rapporto di Prova tipo 2.2 UNI EN10204

A	L	B	WFL	€		
mm	mm	mm	kg			
10	87	21	30	10,10	5	082670210
12	118	22	70	16,90	2	082670213

Robur

8272

girelli a due occhi
inox AISI 316

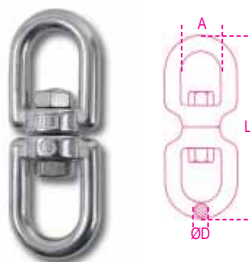

ANALISI DI LABORATORIO

- analisi chimica
 - test di trazione
- CERTIFICATI DISPONIBILI
- Specifica Prodotto
 - Rapporto di Prova tipo 2.2 UNI EN10204

Ø D mm	A mm	L mm	WFL kg	€		
4	11	50	90	5,70	5	082720204
5	13	60	115	7,45	5	082720205
6	15	66	140	9,20	5	082720206
8	19	90	250	14,80	3	082720208
10	23	112	300	22,80	1	082720210
13	33	148	650	46,00	1	082720213
16	38	184	1000	86,00	1	082720216
19	40	223	1600	153,50	1	082720219

8273

girelli a sgancio rapido
con occhio girevole
inox AISI 316



ANALISI DI LABORATORIO

- analisi chimica • test di trazione
- CERTIFICATI DISPONIBILI
- Specifica Prodotto
 - Rapporto di Prova tipo 2.2 UNI EN10204

Ø C x L mm	B mm	WFL kg	BF kg	€		
12x70	12	230	1100	17,40	1	082730012
16x85	14,50	440	2000	24,10	1	082730016
22x120	20	700	3500	38,00	1	082730022

8282S

ganci a "S" simmetrici
inox AISI 316

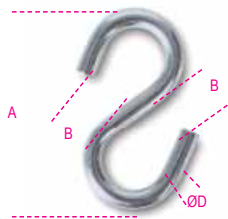

ANALISI DI LABORATORIO

- analisi chimica
 - test di trazione
- CERTIFICATI DISPONIBILI
- Specifica Prodotto
 - Rapporto di Prova tipo 2.2 UNI EN10204

Ø D mm	B mm	A mm	WFL kg	€		
3	5,5	34	4	0,31	40	082820303
4	7,0	40	5	0,62	30	082820304
5	9,0	46	12	1,01	20	082820305
6	10	54	18	1,68	15	082820306

8284

terminali gancio a pellicano
inox AISI 316



ANALISI DI LABORATORIO

- analisi chimica
 - test di trazione
- CERTIFICATI DISPONIBILI
- Specifica Prodotto
 - Rapporto di Prova tipo 2.2 UNI EN10204

Ø C mm	B mm	L mm	WFL kg	€		
6	11	73	200	16,80	3	082840006
8	14	98	300	22,70	3	082840008
10	23	143	450	47,00	1	082840010

8285

terminali a forcella
inox AISI 316

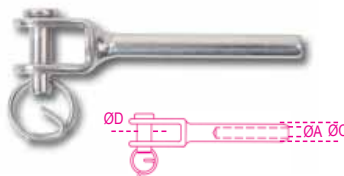

ANALISI DI LABORATORIO

- analisi chimica
 - test di trazione
- CERTIFICATI DISPONIBILI
- Specifica Prodotto
 - Rapporto di Prova tipo 2.2 UNI EN10204

Ø A M	Ø C mm	Ø D mm	WFL kg	€		
3	6,3	6	180	3,35	5	082850203
4	7,5	8	200	5,40	3	082850204
5	9	10	330	7,35	2	082850205
6	12,5	12	720	15,30	2	082850206
7	12,5	12	850	16,40	2	082850207
8	15,5	16	1120	22,00	2	082850208
10	18	16	1300	31,00	2	082850210
12	20	19	2400	37,00	2	082850212

8286

terminali ad occhio
inox AISI 316



ANALISI DI LABORATORIO

- analisi chimica
 - test di trazione
- CERTIFICATI DISPONIBILI
- Specifica Prodotto
 - Rapporto di Prova tipo 2.2 UNI EN10204

Ø D M	Ø A mm	Ø C mm	WFL kg	€		
3	6,5	6,3	180	3,45	5	082860203
4	8,5	7,5	200	4,00	3	082860204
5	10	9	330	5,40	2	082860205
6	12,5	12,6	720	8,85	2	082860206
7	12,5	14,2	850	9,55	2	082860207
8	14,5	16	1120	16,00	2	082860208
10	16,4	18	1300	28,00	2	082860210
12	19,3	20	2400	40,00	2	082860212

8287

terminali a tubo
inox AISI 316

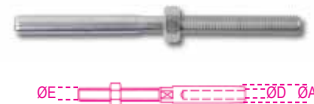

ANALISI DI LABORATORIO

- analisi chimica
 - test di trazione
- CERTIFICATI DISPONIBILI
- Specifica Prodotto
 - Rapporto di Prova tipo 2.2 UNI EN10204

Ø D M	Ø A mm	E mm	WFL kg	€		
3	6,2	M6	180	3,00	5	082870203
4	7,5	M8	200	4,25	3	082870204
5	8,7	M10	330	5,95	2	082870205
6	12,6	M12	720	10,90	2	082870206
7	12,6	M14	850	15,20	2	082870207
8	16	M16	1120	22,00	2	082870208
10	18	M16	1300	24,40	2	082870210
12	20	M20	2400	33,50	2	082870212

8290

ponticelli
inox AISI 316



ANALISI DI LABORATORIO

- analisi chimica
- CERTIFICATI DISPONIBILI
- Specifica Prodotto
 - Rapporto di Prova tipo 2.2 UNI EN10204

Ø A mm	B mm	Ø C mm	L mm	€		
5	18	4,3	40	1,08	5	082900205
6	22	5,2	44	1,53	5	082900206
8	23	5,2	51	2,41	5	082900208



8381SX

collari per sostegno tubazioni,
acciaio inox

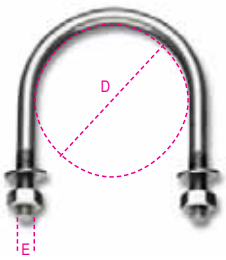

AISI 304

ANALISI DI LABORATORIO

- analisi chimica
- CERTIFICATI DISPONIBILI
- Rapporto di Prova tipo 2.2 UNIEN10204

D mm	D gas	E mm	€		
11	1/8"	M6	2,67	20	083810401
14	1/4"	M6	2,74	20	083810402
18	3/8"	M6	2,81	20	083810403
22	1/2"	M6	2,87	20	083810404
27	3/4"	M6	2,92	20	083810405
34	1"	M6	3,10	20	083810406
43	1 1/4"	M6	3,55	20	083810407
49	1 1/2"	M8	6,35	10	083810408
61	2"	M8	7,00	10	083810409
77	2 1/2"	M8	8,05	10	083810410
89	3"	M8	8,95	10	083810412
115	4"	M8	11,50	10	083810413
168	6"	M10	22,00	1	083810416
220	8"	M10	26,50	1	083810418

8279

catene tipo Genovese
per collegamenti statici
INOX Aisi 304



DATI TECNICI

- coefficiente di sicurezza: 4
- CERTIFICATI DISPONIBILI
- Specifica Prodotto
- Rapporto di Prova tipo 2.2 UNI EN10204

Ø mm	nr	WFL kg	m	€	
2	13	20	50	260,00	1 082790020
3	17	55	50	474,00	1 082790030
4	19	100	50	668,00	1 082790040
5	21	250	40	734,00	1 082790050
6	23	310	30	747,00	1 082790060
8	27	400	15	734,00	1 082790080
10	30	1000	10	1.150,00	1 082790400

Attenzione: prodotto NON destinato al sollevamento

8293

sistemi di legatura a cricchetto AISI 304
nastro in poliestere ad alta tenacità LC 300kg
ganci uncino

in confezione appendibile



L m	L2 mm	L1 mm	STF daN	€	
6	5700	300	100	74,50	1 082930106

LC = 300 kg

8297C

sistemi di legatura ad anello
con mini cricchetto AISI 304
nastro in poliestere ad alta tenacità LC 700kg

in confezione appendibile

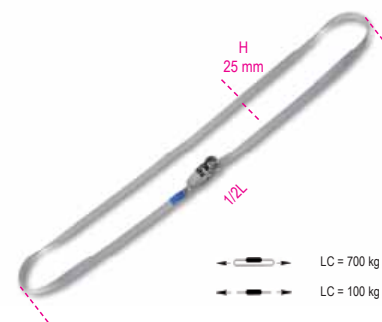

L m	H mm	€	
5	25	28,50	1 082970350

LC = 700 kg

8297F

2 sistemi di legatura ad anello
con fibbia AISI 304
nastro in poliestere ad alta tenacità LC 250kg

in confezione appendibile

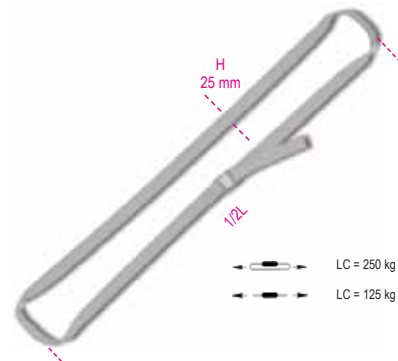

L m	H mm	€	
3	25	28,50	1 082970230

LC = 250 kg

BRACHE DI NASTRO IN POLIESTERE UNI EN1492-1 e UNI EN1492-2

DATI TECNICI

- coefficiente di sicurezza: 7
- codice lotto di fabbricazione

ANALISI DI LABORATORIO

- test di trazione

CERTIFICATI DISPONIBILI

- Specifica Prodotto
- Rapporto di Prova tipo 2.2 UNI EN10204
- Certificato del Fabbricatore UNI EN1492
- Dichiarazione di Conformità CE

			$\beta = 0^\circ + 45^\circ$	$\beta = 45^\circ + 60^\circ$
1t	0,8t	2t	1,4t	1t
2t	1,6t	4t	2,8t	2t
3t	2,4t	6t	4,2t	3t
4t	3,2t	8t	5,6t	4t
5t	4t	10t	7t	5t
6t	4,8t	12t	8,4t	6t
8t	6,4t	16t	11,2t	8t
10t	8t	20t	14t	10t
12t	9,6t	24t	16,8t	12t
15t	12t	30t	21t	15t
20t	16t	40t	28t	20t
25t	20t	50t	35t	25t
30t	24t	60t	42t	30t
40t	32t	80t	56t	40t
50t	40t	100t	70t	50t

8150

brache per sollevamento 1t viola
nastro piatto a due strati, asole rinforzate,
poliestere alta tenacità (PES)

CE



UNI EN 1492-1

L m	H mm	WLL ton	€	
0,5	30	1	4,75	1 081500005
1	30	1	6,00	1 081500010
1,5	30	1	7,70	1 081500015
2	30	1	8,50	1 081500020
2,5	30	1	9,75	1 081500025
3	30	1	10,80	1 081500030
3,5	30	1	12,00	1 081500035
4	30	1	13,90	1 081500040
5	30	1	16,40	1 081500050
6	30	1	18,80	1 081500060
8	30	1	24,50	1 081500080

Robur



8153

brache per sollevamento 2t verde
nastro piatto a due strati, asole rinforzate,
poliestere alta tenacità (PES)

CE

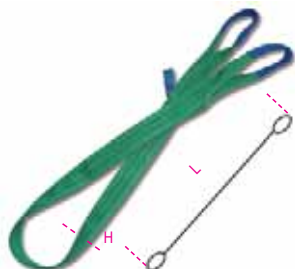

UNI EN 1492-1

L m	H mm	WLL ton	€	🚚	🏠
1	60	2	9,45	1	081530010
1,5	60	2	12,70	1	081530015
2	60	2	14,60	1	081530020
2,5	60	2	17,20	1	081530025
3	60	2	19,90	1	081530030
3,5	60	2	23,20	1	081530035
4	60	2	24,50	1	081530040
5	60	2	30,00	1	081530050
6	60	2	35,50	1	081530060
8	60	2	45,00	1	081530080
10	60	2	54,50	1	081530100

8156

brache per sollevamento 3t giallo
nastro piatto a due strati, asole rinforzate,
poliestere alta tenacità (PES)

CE

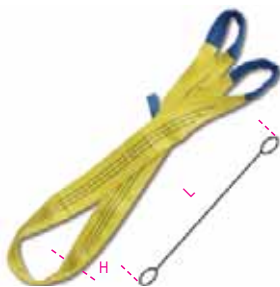

UNI EN 1492-1

L m	H mm	WLL ton	€	🚚	🏠
1	90	3	13,40	1	081560010
1,5	90	3	17,70	1	081560015
2	90	3	21,90	1	081560020
2,5	90	3	26,00	1	081560025
3	90	3	30,50	1	081560030
3,5	90	3	34,00	1	081560035
4	90	3	37,50	1	081560040
5	90	3	45,50	1	081560050
6	90	3	53,00	1	081560060
8	90	3	69,50	1	081560080
10	90	3	85,00	1	081560100
12	90	3	106,50	1	081560120

8157

brache per sollevamento 4t grigio
nastro piatto a due strati, asole rinforzate,
poliestere alta tenacità (PES)

CE



UNI EN 1492-1

L m	H mm	WLL ton	€	🚚	🏠
2	120	4	30,00	1	081570020
3	120	4	40,00	1	081570030
4	120	4	51,50	1	081570040
5	120	4	62,50	1	081570050
6	120	4	72,50	1	081570060
8	120	4	94,00	1	081570080
10	120	4	115,50	1	081570100
12	120	4	169,00	1	081570120

8158

brache per sollevamento 5t rosso
nastro piatto a due strati, asole rinforzate,
poliestere alta tenacità (PES)

CE



UNI EN 1492-1

L m	H mm	WLL ton	€	🚚	🏠
2	150	5	41,50	1	081580020
3	150	5	54,50	1	081580030
4	150	5	69,50	1	081580040
5	150	5	83,50	1	081580050
6	150	5	99,00	1	081580060
8	150	5	127,50	1	081580080
10	150	5	156,50	1	081580100
12	150	5	229,00	1	081580120



8159

brache per sollevamento 6t marrone
nastro piatto a due strati, asole rinforzate,
poliestere alta tenacità (PES)

CE

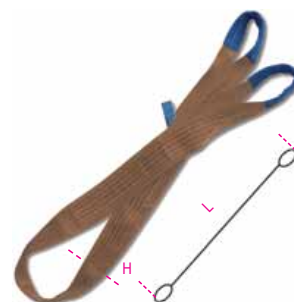

UNI EN 1492-1

L m	H mm	WLL ton	€	🚚	🏠
2	180	6	51,50	1	081590020
3	180	6	76,00	1	081590030
4	180	6	97,50	1	081590040
5	180	6	117,50	1	081590050
6	180	6	137,50	1	081590060
8	180	6	179,50	1	081590080
10	180	6	222,00	1	081590100

8160

brache per sollevamento 8t blu
nastro piatto a due strati, asole rinforzate,
poliestere alta tenacità (PES)

CE

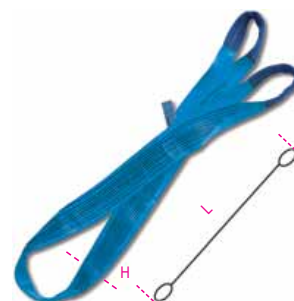

UNI EN 1492-1

L m	H mm	WLL ton	€	🚚	🏠
3	240	8	104,50	1	081600030
4	240	8	133,00	1	081600040
5	240	8	158,00	1	081600050
6	240	8	187,50	1	081600060
8	240	8	241,00	1	081600080
10	240	8	300,00	1	081600100



8161

brache per sollevamento arancio
10t nastro piatto a due strati,
20t nastro piatto a quattro strati,
asole rinforzate

CE

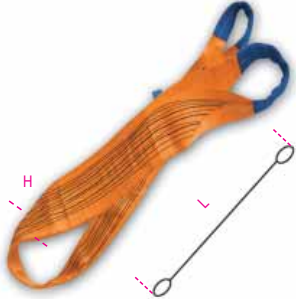

UNI EN 1492-1

L m	H mm	WLL ton	€		
3	300	10	143,50	1	081610030
4	300	10	211,50	1	081610040
5	300	10	254,00	1	081610050
6	300	10	295,00	1	081610060
8	300	10	390,00	1	081610080
10	300	10	475,00	1	081610100
12	300	10	571,00	1	081610120
3	300	20	470,00	1	081612030
4	300	20	590,00	1	081612040
5	300	20	711,00	1	081612050
6	300	20	831,00	1	081612060
8	300	20	1.071,00	1	081612080
10	300	20	1.310,00	1	081612100
12	300	20	1.555,00	1	081612120

8170

brache per sollevamento 1t
nastro ad anello continuo, viola
tessuto in poliestere ad alta tenacità (PES)

CE



UNI EN 1492-2

L m	WLL ton	H mm	€		
0,5	1	45	5,40	1	081700010
1	1	45	7,05	1	081700020
1,5	1	45	9,95	1	081700030
2	1	45	13,00	1	081700040
2,5	1	45	16,00	1	081700050
3	1	45	18,80	1	081700060
4	1	45	24,90	1	081700080
5	1	45	31,00	1	081700100

8173

brache per sollevamento 2t
nastro ad anello continuo, verde
tessuto in poliestere ad alta tenacità (PES)

CE

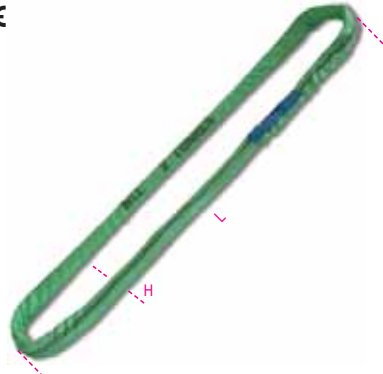

UNI EN 1492-2

L m	H mm	WLL ton	€		
0,5	50	2	7,05	1	081730010
1	50	2	10,80	1	081730020
1,5	50	2	15,70	1	081730030
2	50	2	20,60	1	081730040
2,5	50	2	25,50	1	081730050
3	50	2	30,00	1	081730060
4	50	2	40,50	1	081730080
5	50	2	50,50	1	081730100
6	50	2	60,50	1	081730120
8	50	2	79,00	1	081730160

8176

brache per sollevamento 3t
nastro ad anello continuo, giallo
tessuto in poliestere ad alta tenacità (PES)

CE



UNI EN 1492-2

L m	H mm	WLL ton	€		
0,5	60	3	7,80	1	081760010
1	60	3	14,20	1	081760020
1,5	60	3	20,60	1	081760030
2	60	3	26,50	1	081760040
2,5	60	3	33,00	1	081760050
3	60	3	40,00	1	081760060
4	60	3	53,00	1	081760080
5	60	3	66,50	1	081760100
6	60	3	80,00	1	081760120
8	60	3	105,50	1	081760160

8177

brache per sollevamento 4t
nastro ad anello continuo, grigio
tessuto in poliestere ad alta tenacità (PES)

CE

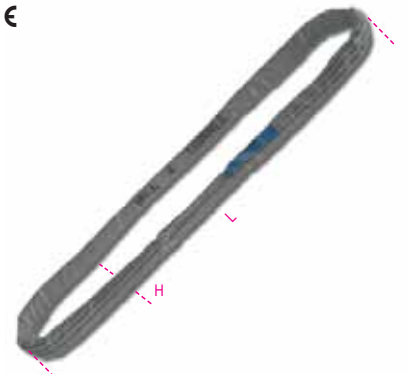

UNI EN 1492-2

L m	H mm	WLL ton	€		
0,5	65	4	15,60	1	081770010
1	65	4	16,80	1	081770020
1,5	65	4	24,90	1	081770030
2	65	4	32,50	1	081770040
2,5	65	4	41,00	1	081770050
3	65	4	49,00	1	081770060
4	65	4	64,00	1	081770080
5	65	4	80,00	1	081770100
6	65	4	95,50	1	081770120
8	65	4	127,50	1	081770160

8178

brache per sollevamento 5t
nastro ad anello continuo, rosso
tessuto in poliestere ad alta tenacità (PES)

CE

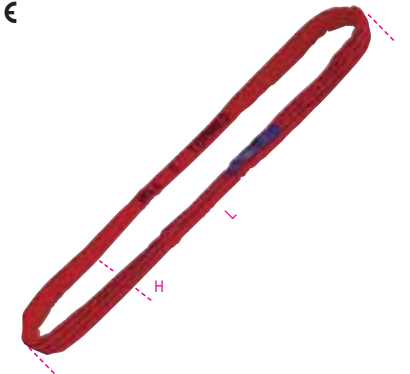

UNI EN 1492-2

L m	H mm	WLL ton	€		
0,5	70	5	20,90	1	081780010
1	70	5	24,50	1	081780020
1,5	70	5	31,00	1	081780030
2	70	5	41,00	1	081780040
2,5	70	5	50,00	1	081780050
3	70	5	59,50	1	081780060
4	70	5	79,00	1	081780080
5	70	5	99,00	1	081780100
6	70	5	118,00	1	081780120
8	70	5	158,00	1	081780160

8179M

brache per sollevamento 6t
nastro ad anello continuo, marrone
tessuto in poliestere ad alta tenacità (PES)

CE

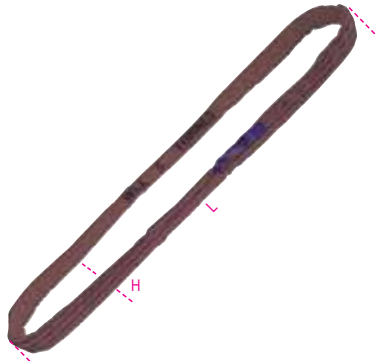

UNI EN 1492-2

L m	H mm	WLL ton	€	🚚	📄
1	80	6	26,50	1	081790020
1,5	80	6	38,50	1	081790030
2	80	6	50,50	1	081790040
2,5	80	6	62,50	1	081790050
3	80	6	73,00	1	081790060
4	80	6	98,00	1	081790080
5	80	6	123,00	1	081790100
6	80	6	146,00	1	081790120
8	80	6	194,50	1	081790160

8179B

brache per sollevamento 8t
nastro ad anello continuo, blu
tessuto in poliestere ad alta tenacità (PES)

CE

UNI EN 1492-2

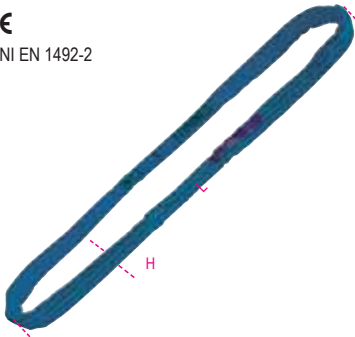

L m	H mm	WLL ton	€	🚚	📄
1	85	8	33,50	1	081790220
1,5	85	8	50,50	1	081790230
2	85	8	67,50	1	081790240
2,5	85	8	83,50	1	081790250
3	85	8	97,00	1	081790260
4	85	8	129,00	1	081790280
5	85	8	166,00	1	081790300
6	85	8	194,00	1	081790320
8	85	8	258,00	1	081790360

8179A

brache per sollevamento 10t÷50t
nastro ad anello continuo, arancio
tessuto in poliestere ad alta tenacità (PES)

CE

UNI EN 1492-2



L m	H mm	WLL ton	€	🚚	📄
1	95	10	50,50	1	081790502
1,5	95	10	69,50	1	081790503
2	95	10	98,50	1	081790504
2,5	95	10	115,00	1	081790505
3	95	10	152,00	1	081790506
4	95	10	198,00	1	081790508
5	95	10	222,00	1	081790510
6	95	10	294,00	1	081790512
8	95	10	360,00	1	081790516
10	95	10	494,00	1	081790520
12	95	10	525,00	1	081790524

2	100	12	169,00	1	081791204
2,5	100	12	200,00	1	081791205
3	100	12	230,50	1	081791206
3,5	100	12	260,00	1	081791207
4	100	12	292,00	1	081791208
4,5	100	12	295,00	1	081791209
5	100	12	353,00	1	081791210
5,5	100	12	384,00	1	081791211
6	100	12	414,00	1	081791212
6,5	100	12	445,00	1	081791213
7	100	12	476,00	1	081791214
7,5	100	12	506,00	1	081791215
8	100	12	536,00	1	081791216
8,5	100	12	568,00	1	081791217
9	100	12	599,00	1	081791218
9,5	100	12	629,00	1	081791219
10	100	12	659,00	1	081791220

2	110	15	209,50	1	081791504
2,5	110	15	245,00	1	081791505
3	110	15	279,00	1	081791506
3,5	110	15	316,00	1	081791507
4	110	15	351,00	1	081791508
4,5	110	15	385,00	1	081791509
5	110	15	420,00	1	081791510
5,5	110	15	457,00	1	081791511
6	110	15	491,00	1	081791512
6,5	110	15	527,00	1	081791513
7	110	15	562,00	1	081791514
7,5	110	15	596,00	1	081791515
8	110	15	633,00	1	081791516
8,5	110	15	668,00	1	081791517
9	110	15	703,00	1	081791518
9,5	110	15	747,00	1	081791519
10	110	15	773,00	1	081791520

2	130	20	246,50	1	081792004
2,5	130	20	289,00	1	081792005
3	130	20	332,00	1	081792006
3,5	130	20	374,00	1	081792007
4	130	20	418,00	1	081792008
4,5	130	20	460,00	1	081792009
5	130	20	503,00	1	081792010
5,5	130	20	546,00	1	081792011
6	130	20	589,00	1	081792012
6,5	130	20	631,00	1	081792013
7	130	20	673,00	1	081792014
7,5	130	20	716,00	1	081792015
8	130	20	759,00	1	081792016
8,5	130	20	803,00	1	081792017
9	130	20	845,00	1	081792018
9,5	130	20	888,00	1	081792019
10	130	20	931,00	1	081792020

2	135	25	273,00	1	081792504
2,5	135	25	326,00	1	081792505
3	135	25	380,00	1	081792506
3,5	135	25	432,00	1	081792507
4	135	25	487,00	1	081792508
4,5	135	25	540,00	1	081792509
5	135	25	594,00	1	081792510
5,5	135	25	647,00	1	081792511
6	135	25	701,00	1	081792512
6,5	135	25	755,00	1	081792513
7	135	25	809,00	1	081792514
7,5	135	25	861,00	1	081792515
8	135	25	915,00	1	081792516
8,5	135	25	969,00	1	081792517
9	135	25	1.023,00	1	081792518
9,5	135	25	1.076,00	1	081792519
10	135	25	1.129,00	1	081792520

2	160	30	320,00	1	081793004
2,5	160	30	385,00	1	081793005
3	160	30	451,00	1	081793006
3,5	160	30	516,00	1	081793007
4	160	30	582,00	1	081793008
4,5	160	30	647,00	1	081793009
5	160	30	712,00	1	081793010
5,5	160	30	777,00	1	081793011
6	160	30	843,00	1	081793012
6,5	160	30	908,00	1	081793013
7	160	30	972,00	1	081793014
7,5	160	30	1.038,00	1	081793015
8	160	30	1.103,00	1	081793016
8,5	160	30	1.167,00	1	081793017
9	160	30	1.230,00	1	081793018
9,5	160	30	1.300,00	1	081793019
10	160	30	1.365,00	1	081793020

2	165	40	445,00	1	081794004
2,5	165	40	497,00	1	081794005
3	165	40	578,00	1	081794006
3,5	165	40	660,00	1	081794007
4	165	40	742,00	1	081794008
4,5	165	40	823,00	1	081794009
5	165	40	905,00	1	081794010
5,5	165	40	987,00	1	081794011
6	165	40	1.068,00	1	081794012
6,5	165	40	1.150,00	1	081794013
7	165	40	1.230,00	1	081794014
7,5	165	40	1.315,00	1	081794015
8	165	40	1.390,00	1	081794016
8,5	165	40	1.480,00	1	081794017
9	165	40	1.560,00	1	081794018
9,5	165	40	1.640,00	1	081794019
10	165	40	1.720,00	1	081794020

3	180	50	670,00	1	081795006
3,5	180	50	765,00	1	081795007
4	180	50	859,00	1	081795008
4,5	180	50	951,00	1	081795009
5	180	50	1.044,00	1	081795010
5,5	180	50	1.137,00	1	081795011
6	180	50	1.230,00	1	081795012
6,5	180	50	1.325,00	1	081795013
7	180	50	1.415,00	1	081795014
7,5	180	50	1.510,00	1	081795015
8	180	50	1.600,00	1	081795016
8,5	180	50	1.690,00	1	081795017
9	180	50	1.780,00	1	081795018
9,5	180	50	1.880,00	1	081795019
10	180	50	1.970,00	1	081795020

 Robur

 Robur

8166

guaine antiabrasione per brache di sollevamento,
in poliestere ad alta tenacità (PES)
con sottostrato elastomerico



H mm	ø mm	L m	€		
70	45	3	21,70	1	081660073
80	52	3	25,50	1	081660083
110	70	3	31,00	1	081660103
155	100	3	65,00	1	081660153
170	110	3	71,50	1	081660170
235	150	4	195,00	1	081660235

H mm			
70	8150	8170-8173	081660073
80	8153	8176	081660083
110	8153-8156	8177-8178	081660103
155	8157	8178-8179A 8179B-8179M	081660153
170	8158	-	081660170
235	8159	-	081660235

8090F

maglie di giunzione da sollevamento,
per brache in poliestere,
acciaio legato ad alta resistenza
grado 8

CE

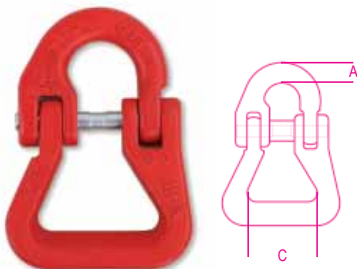

EN 1677-1

DATI TECNICI

- coefficiente di sicurezza: 4
- trattamento termico: bonifica
- codice lotto fabbricazione
- ANALISI DI LABORATORIO
- analisi chimica, analisi metallografica
- test carico di prova (WLL x 2,5)
- test di trazione
- test di fatica (min. 20.000 cicli)

CERTIFICATI DISPONIBILI

- Specifica Prodotto
- Rapporto di Prova tipo 2.2 UNI EN10204
- Certificato di Controllo tipo 3.1 UNI EN10204
- Dichiarazione di Conformità CE

WLL kg	ø mm	A mm	C mm	€	
2000	7-8	10,5	40	26,50	1 080900220
3150	10	12	50	33,50	1 080900232
5300	13	17	60	51,00	1 080900253
8000	16	21	75	78,50	1 080900280

SISTEMI DI ANCORAGGIO E LEGATURA

UNI EN 12195

DATI TECNICI

- coefficiente di sicurezza: 2
- codice di identificazione

ANALISI DI LABORATORIO

- test pretensionabilità cricchetto
- test di deformazione parti metalliche
- test di trazione sistema completo

CERTIFICATI DISPONIBILI

- Specifica Prodotto
- Rapporto di Prova tipo 2.2 UNI EN10204

8180

sistemi di ancoraggio a cricchetto LC 750kg
nastro in poliestere ad alta tenacità (PES)
ganci a uncino

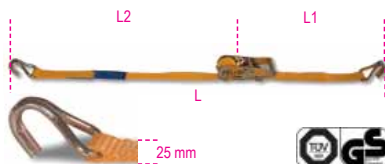

EN 12195-2

L m	L2 mm	L1 mm	STF daN	€	
4	3750	250	200	12,70	1 081800004
6	5750	250	200	14,70	1 081800006
8	7750	250	200	16,50	1 081800008

LC = 750 kg

8181

sistemi di ancoraggio a cricchetto LC 1000kg
nastro in poliestere ad alta tenacità (PES)
ganci a uncino

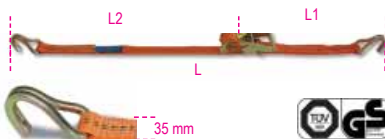

EN 12195-2

L m	L2 mm	L1 mm	STF daN	€	
4	3600	400	180	15,60	1 081810004
6	5600	400	180	17,80	1 081810006
8	7600	400	180	19,50	1 081810008

LC = 1000 kg

8181 6/S4

Kit 4 sistemi di ancoraggio LC 1000kg
con zainetto in poliestere impermeabile

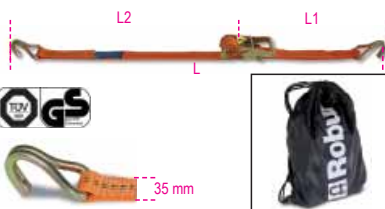

EN 12195-2

L mm	L1 mm	L2 mm	STF daN	€	
6	400	5600	180	78,50	1 081810906

8181S

sistemi di ancoraggio a cricchetto LC 1000kg
nastro in poliestere ad alta tenacità (PES)
ganci sponda

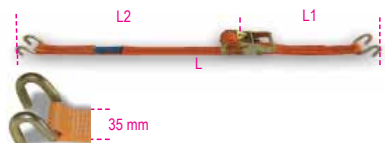

EN 12195-2

L m	L2 mm	L1 mm	STF daN	€	
6	5600	400	180	17,30	1 081810206

LC = 1000 kg

8182E

sistemi di ancoraggio a cricchetto per interni
furgoni e autocarri, LC 1000kg
nastro in poliestere ad alta tenacità (PES)

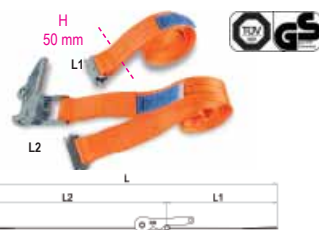

EN 12195-2

L m	L2 mm	L1 mm	STF daN	€	
4	3500	500	220	17,80	1 081820440

LC = 1000 kg

	L2 mm	L1 mm	€	
8182EL 2500	2500		5,50	1 081820942
8182EC 1500	1500		11,80	1 081820945

8182T

sistemi di ancoraggio a cricchetto LC 1500kg
nastro in poliestere ad alta tenacità (PES)
ganci a uncino

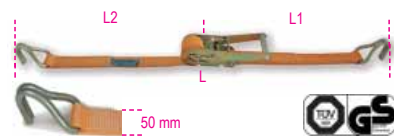

EN 12195-2

L m	L2 mm	L1 mm	STF daN	€	
8,5	8100	400	300	27,50	1 081821085
10,5	10100	400	300	30,00	1 081821105

LC = 1500 kg

8182TS

sistemi di ancoraggio a cricchetto LC 1500kg
nastro in poliestere ad alta tenacità (PES)
ganci sponda

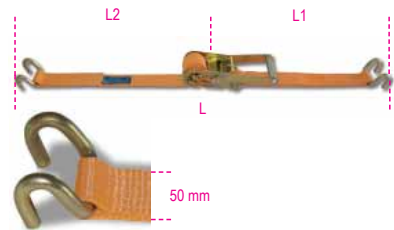

EN 12195-2

L m	L2 mm	L1 mm	STF daN	€	
8,5	8100	400	300	28,50	1 081821285
10,5	10100	400	300	32,00	1 081821305

LC = 1500 kg

8182

systemi di ancoraggio a cricchetto LC 2000kg
nastro in poliestere ad alta tenacità (PES)
ganci a uncino

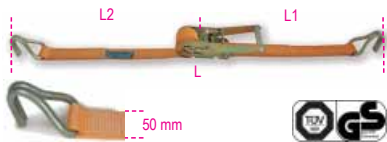

EN 12195-2

L m	L2 mm	L1 mm	STF daN	€	Icon	Icon	Code
4,5	4100	400	300	24,70	1		081820045
6,5	6100	400	300	29,00	1		081820065
8,5	8100	400	300	31,50	1		081820085
10,5	10100	400	300	36,00	1		081820105
14,5	14100	400	300	40,50	1		081820145
16,5	16100	400	300	46,50	1		081820165

LC = 2000 kg

	L2 mm	L1 mm	€	Icon	Icon	Code
8182LP 8100	8100		17,30	1		081820902
8182SP 400		400	17,80	1		081820905

8182 8,5/S2

Kit 2 sistemi di ancoraggio LC 2000kg
con zainetto in poliestere impermeabile



EN 12195-2

L m	L1 mm	L2 mm	STF daN	€	Icon	Icon	Code
8,5	400	8100	300	70,50	1		081821985

8182S

systemi di ancoraggio a cricchetto LC 2000kg
nastro in poliestere ad alta tenacità (PES)
ganci sponda

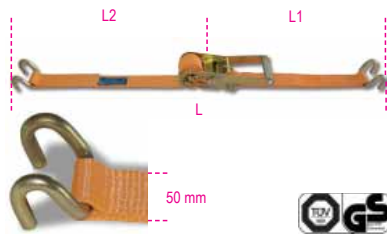

EN 12195-2

L m	L1 mm	L2 mm	STF daN	€	Icon	Icon	Code
6,5	400	6100	300	28,50	1		081820265
8,5	400	8100	300	32,50	1		081820285
10,5	400	10100	300	36,00	1		081820305

LC = 2000 kg

	L1 mm	L2 mm	€	Icon	Icon	Code
8182SLP 8100		8100	16,90	1		081820912
8182SSP 400	400		17,30	1		081820915

8182GD

systemi di ancoraggio a cricchetto LC 2000kg
nastro in poliestere ad alta tenacità (PES)
con ganci delta



EN 12195-2

L m	L2 mm	L1 mm	STF daN	€	Icon	Icon	Code
8,5	8100	400	300	37,50	1		081820485

LC = 2000 kg

8182A

systemi di ancoraggio a cricchetto con 2 asole
nastro in poliestere ad alta tenacità (PES)
LC 2000kg

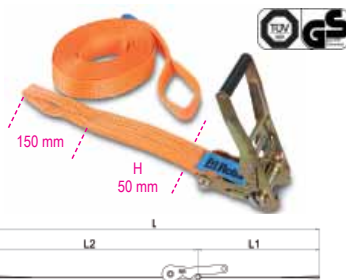

EN 12195-2

L m	L2 mm	L1 mm	STF daN	€	Icon	Icon	Code
8,5	8100	400	300	32,50	1		081820585

LC = 2000 kg

8182H

systemi di ancoraggio a cricchetto LC 2500kg
nastro in poliestere ad alta tenacità (PES)
ganci a uncino

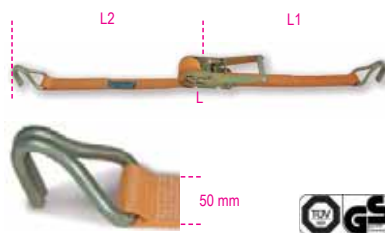

EN 12195-2

L m	L2 mm	L1 mm	STF daN	€	Icon	Icon	Code
6,5	6100	400	300	32,00	1		081820406
8,5	8100	400	300	34,50	1		081820408
10,5	10100	400	300	38,00	1		081820410
14,5	14100	400	300	48,00	1		081820414

LC = 2500 kg

8182H/2

systemi di ancoraggio a cricchetto LC 2500kg
nastro in poliestere ad alta tenacità (PES)
ganci sponda

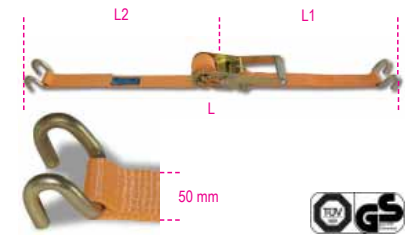

EN 12195-2

L m	L1 mm	L2 mm	STF daN	€	Icon	Icon	Code
8,5	8100	400	300	36,50	1		081820385

LC = 2500 kg

8184

systemi di ancoraggio a cricchetto inverso a
leva lunga LC 2500kg
nastro in poliestere ad alta tenacità (PES)
ganci a uncino



EN12195-2

L m	L2 mm	L1 mm	STF daN	€	Icon	Icon	Code
6,5	6100	400	500	35,50	1		081840065
8,5	8100	400	500	37,00	1		081840085
10,5	10100	400	500	40,00	1		081840105

LC = 2500 kg

8183

systemi di ancoraggio a cricchetto LC 5000kg
nastro in poliestere ad alta tenacità (PES)
ganci a uncino



EN 12195-2

L m	L2 mm	L1 mm	STF daN	€	Icon	Icon	Code
8,5	8000	500	500	100,50	1		081830085
12,5	12000	500	500	119,50	1		081830125

LC = 5000 kg



8190

tendicatena di ancoraggio a cricchetto
con due ganci per catene di ancoraggio 8190B
Grado 8



EN12195/3

DATI TECNICI

- coefficiente di sicurezza: 2
- trattamento termico: ganci bonificati
- codice lotto

ANALISI DI LABORATORIO

- analisi chimica, analisi metallografica
- test di trazione

CERTIFICATI DISPONIBILI

- Specifica Prodotto
- Rapporto di Prova tipo 2.2 UNI EN10204
- Certificato di Controllo tipo 3.1 UNI EN10204

Ø mm	LC daN	Ø mm	LC daN	€		
10	6300	8	4000	83,00	1	081900010
13	10000	-	-	130,00	1	081900013

* ATTENZIONE: il prodotto può essere utilizzato con catena 8mm con opportuna riduzione del carico (LC 4000daN)

8190B

catene di ancoraggio carichi
per tendicatena a cricchetto 8190
Grado 8



EN12195/3

DATI TECNICI

- coefficiente di sicurezza: 2
- trattamento termico: bonifica
- piastrina di identificazione seriale

ANALISI DI LABORATORIO

- analisi chimica,
- analisi metallografica
- test carico di rottura

CERTIFICATI ALLEGATI

- Certificato del Fabbricante
- Rapporto di Prova tipo 2.2 UNI EN10204
- Specifica Prodotto

Ø mm	LC daN	L m	L1 m	€		
8	4000	3,5	3,30	181,50	1	081901308
10	6300	3,5	3,28	276,00	1	081901310
13	10000	3,5	3,23	403,00	1	081901313

Robur

8185

sistemi di ancoraggio ad anello LC 1500kg
con cricchetto tenditore
nastro in poliestere ad alta tenacità (PES)



EN 12195-2

L m	STF daN	€		
5	200	10,50	1	081850005
8	200	12,70	1	081850008

8186

sistemi di ancoraggio ad anello LC 2000kg
con cricchetto tenditore
nastro in poliestere ad alta tenacità (PES)



EN 12195-2

L m	STF daN	€		
5	180	12,70	1	081860005
8	180	16,20	1	081860008

8187

sistemi di ancoraggio ad anello LC 4000kg
con cricchetto tenditore
nastro in poliestere ad alta tenacità (PES)



EN 12195-2

L m	STF daN	€		
5	350	23,40	1	081870005
8	350	27,50	1	081870008

8188C

sistemi di legatura ad anello LC 800kg
con cricchetto tenditore
nastro in poliestere ad alta tenacità (PES)



EN 12195-2

L m	STF daN	€		
1,5	72	4,20	3	081880315
2,5	72	5,00	3	081880325
5	72	6,20	3	081880350

8188CG/25

sistemi di legatura con 2 ganci ed asole,
cricchetto tenditore LC 400kg
nastro in poliestere ad alta tenacità (PES)



EN 12195-2

L m	L1 mm	L2 mm	STF daN	€		
3	480	170	120	9,35	1	081880430
5	480	170	120	10,10	1	081880450

Robur

8188CU/25

sistemi di legatura con ganci uncino, cricchetto tenditore LC 400kg nastro in poliestere ad alta tenacità (PES)



EN 12195-2

L m	L1 mm	L2 mm	€	Icon	Icon	Code
5	300	4700	9,60			1 081880750

8188F

sistemi di legatura ad anello LC 200kg con fibbia di serraggio nastro in polipropilene ad alta tenacità (PP)

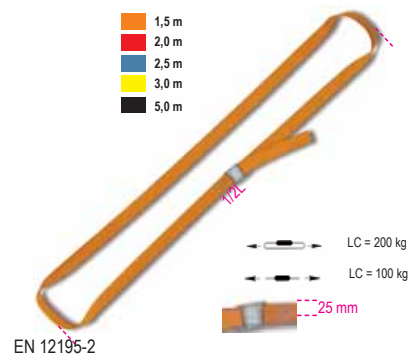

EN 12195-2

L m	€	Icon	Icon	Code
1,5	2,40			10 081880215
2,0	2,58			10 081880220
2,5	2,87			10 081880225
3,0	3,05			10 081880230
5,0	3,90			6 081880250

8188F35

sistemi di legatura ad anello LC 500kg con fibbia di serraggio nastro in polipropilene ad alta tenacità (PP)



EN 12195-2

L m	€	Icon	Icon	Code
5	8,70			1 081880295

8188FG2

sistemi di legatura con 2 ganci ed asole, fibbia di serraggio LC 250kg nastro in polipropilene ad alta tenacità (PP)



EN 12195-2

L m	L1 mm	L2 mm	€	Icon	Icon	Code
3	450	110	12,40			1 081881530

8188/K8

Kit sistemi di legatura con 8 accessori



8188/K8	€	Icon	Icon	Code
	36,50			1 081880801

8488K	0,65m - 7kg
8488K	0,80m - 7kg
8188CL	4m - 500kg
8188FP	2,5m - 250kg

8189

nastro di legatura poliestere (PES), in rotoli
pezze con lunghezza variabile: minima continua garantita 30m



H mm	L m	LC kg	€	Icon	Icon	Code
25	100	750	84,50			1 081890902
35	100	1000	107,00			1 081890903
50	100	2000	171,50			1 081890905

8189A

tappetino antiscivolo per il fissaggio del carico



L m	H mm	S mm	μ	€	Icon	Icon	Code
5	250	8	0,6	67,00			1 081890525

8189PA

2 protezioni angolari per nastri di ancoraggio in poliestere



L1xL2 mm	H1 mm	H2 mm	€	Icon	Icon	Code
135x90	60	18	4,20			1 081890090

Robur

Articolo	Rapporto di Prova 2.2 (UNI EN 10204)	Certificato di Controllo 3.1 (UNI EN 10204)	Certificato del fabbricante	Dichiarazione di Conformità CE
8001Z	✓	✓		✓
8001TZ	✓	✓		✓
8002ZD	✓			
8003ZD	✓			
8004ND	✓			
8005Z	✓			✓
8005TZ	✓			✓
8006Z	✓			✓
8007Z	✓			✓
8008N	✓			✓
8008TZN	✓			✓
8009FD	✓			
8009Z	✓			✓
8009TZ	✓			✓
8010Z	✓			✓
8010TZ	✓			✓
8011Z	✓			✓
8011TZ	✓			✓
8015	✓		✓	✓
8016	✓			✓
8016DA	✓			✓
8016FR	✓			
8016U2	✓		✓	✓
8016UGK	✓		✓	✓
8018E	✓			
8018T	✓			
8020A	✓			
8021A	✓			
8025	✓	✓		✓
8026A	✓	✓		✓
8026R	✓	✓		✓
8028	✓	✓		✓
8029R	✓	✓		✓
8031R	✓	✓		✓
8032	✓	✓		✓
8040EN	✓	✓		✓
8040EZ	✓	✓		✓
8042EN	✓	✓		✓
8042EZ	✓	✓		✓
8041	✓	✓		✓
8043	✓	✓		✓
8044	✓	✓		✓
8048	✓			
8049	✓	✓		✓
8049A	✓	✓		✓
8049V	✓	✓		✓
8051S	✓	✓		✓
8052	✓	✓		✓
8057R	✓	✓		✓
8058R	✓	✓		✓
8060R	✓	✓		✓
8061R	✓	✓		✓
8062	✓	✓		✓
8063	✓	✓		✓
8063SL	✓	✓		✓
8064S	✓	✓		✓
8065SC	✓	✓		✓
8068S	✓	✓		✓
8074	✓			
8074A	✓			
8074G	✓			
8080	✓			
8080FM	✓			
8085R	✓	✓		✓
8086	✓	✓		✓

Articolo	Rapporto di Prova 2.2 (UNI EN 10204)	Certificato di Controllo 3.1 (UNI EN 10204)	Certificato del fabbricante	Dichiarazione di Conformità CE
8090	✓	✓		✓
8090F	✓	✓		✓
8090R	✓	✓		✓
8091			✓	✓
8091SL			✓	✓
8092			✓	✓
8092SL			✓	✓
8094			✓	✓
8094SL			✓	✓
8096			✓	✓
8096SL			✓	✓
8097			✓	✓
8097SL			✓	✓
8098			✓	✓
8098SL			✓	✓
8100	✓	✓		✓
8105	✓	✓		✓
8109	✓	✓		✓
8110	✓			
8114	✓			
8116	✓			
8120 - 8120D	✓			
8120B	✓			
8121MZC	✓			
8134	✓		✓	✓
8135	✓		✓	✓
8143	✓		✓	✓
8146	✓		✓	✓
8146C	✓		✓	✓
8147C-S-P	✓		✓	✓
8148	✓		✓	✓
8149	✓		✓	✓
8150	✓		✓	✓
8153	✓		✓	✓
8156	✓		✓	✓
8157	✓		✓	✓
8158	✓		✓	✓
8159	✓		✓	✓
8160	✓		✓	✓
8161	✓		✓	✓
8166	✓			
8170	✓		✓	✓
8173	✓		✓	✓
8176	✓		✓	✓
8177	✓		✓	✓
8178	✓		✓	✓
8179M-B-A	✓		✓	✓
8180	✓			
8181	✓			
8181S	✓			
8182	✓			
8182A-GD	✓			
8182E	✓			
8182H-H2	✓			
8182M	✓			
8182S	✓			
8182T	✓			
8182T-TS	✓			
8182TS	✓			
8185	✓			
8186	✓			
8187	✓			
8188C	✓			
8188CG/25	✓			
8188CU	✓			

Articolo	Rapporto di Prova 2.2 (UNI EN 10204)	Certificato di Controllo 3.1 (UNI EN 10204)	Certificato del fabbricante	Dichiarazione di Conformità CE
8188F	✓			
8188VF/35	✓			
8188FG2	✓			
8190	✓	✓		
8190B	✓		✓	
8302Z	✓			
8303Z	✓			
8317DZ	✓			
8317SZ	✓			
8381SL	✓			
8381SP	✓			
8383C	✓			
8383P	✓			
8515V	✓			
8515Z	✓			
8531	✓			
8532	✓			
8535	✓			
8201T	✓			
8205	✓			
8206	✓			
8207	✓			
8209	✓			
8210	✓			
8210F	✓			
8210FTP	✓			
8216	✓			✓
8220	✓			
8225	✓			
8227	✓			
8228	✓			
8240	✓			
8240F	✓	✓		✓
8242	✓			
8242F	✓	✓		✓
8248	✓			
8249	✓			
8249G	✓			
8250	✓			
8264	✓			
8267	✓			
8272	✓			
8273	✓			
8274	✓			
8274A	✓			
8274G	✓			
8276	✓			
8276G	✓			
8278	✓			
8280	✓			
8282	✓			
8282S	✓			
8284	✓			
8285	✓			
8286	✓			
8287	✓			
8290	✓			
8293	✓			
8297C	✓			
8297F	✓			
8381SX	✓			
8702...	✓	✓		
8709...	✓	✓		



Beta
Collection



È una linea di prodotti esclusivi pensati e realizzati come espressione del carattere Beta che comprende oltre 200 creazioni originali di altissima qualità: attrezzature sportive, abbigliamento tecnico e una molteplicità di oggettistica personalizzata. Ideali per dar vita ad iniziative promozionali, e per trascorrere momenti di svago.

9500TL

softshell in tessuto poliestere 100%, 320g, composto da tre strati, guscio esterno in microfibra, membrana intermedia impermeabile e traspirante, interno in pile

DISPONIBILE FINO AD ESAURIMENTO SCORTE



Dimensione	€	Quantità	Articolo
S	193,00	1	095000051
M	193,00	1	095000052
L	193,00	1	095000053
XL	193,00	1	095000054
XXL	193,00	1	095000055

9501TLD

felpa donna in cotone 80%, poliestere 20%, 320 g

DISPONIBILE FINO AD ESAURIMENTO SCORTE



Dimensione	€	Quantità	Articolo
S	94,00	1	095010061
M	94,00	1	095010062
L	94,00	1	095010063
XL	94,00	1	095010064

9501TL

felpa uomo in cotone 80%, poliestere 20%, 320 g

DISPONIBILE FINO AD ESAURIMENTO SCORTE



Dimensione	€	Quantità	Articolo
S	110,00	1	095010051
M	110,00	1	095010052
L	110,00	1	095010053
XL	110,00	1	095010054
XXL	110,00	1	095010055

9502TL
polo 100% cotone piqué, 210 g



Dimensione	€	Icona	Articolo
S	65,00		095020051
M	65,00		095020052
L	65,00		095020053
XL	65,00		095020054
XXL	65,00		095020055

9503TL
T-shirt 100% cotone jersey, 160 g



Dimensione	€	Icona	Articolo
S	42,50		095030051
M	42,50		095030052
L	42,50		095030053
XL	42,50		095030054
XXL	42,50		095030055

9504TL
giacca in tessuto esterno 100% poliestere con trattamento idrorepellente
DISPONIBILE FINO AD ESAURIMENTO SCORTE



Dimensione	€	Icona	Articolo
S	130,50		095040051
M	130,50		095040052
L	130,50		095040053
XL	130,50		095040054
XXL	130,50		095040055

9505TL
gilet in tessuto esterno 100% poliestere con trattamento idrorepellente, imbottitura 100 gr e tasca interna
DISPONIBILE FINO AD ESAURIMENTO SCORTE



Dimensione	€	Icona	Articolo
S	161,00		095050051
M	161,00		095050052
L	161,00		095050053
XL	161,00		095050054
XXL	161,00		095050055

9572LB
t-shirt Beta-March, 100% cotone, 200 g arancione con inserti neri



Dimensione	€	Icona	Articolo
S	51,00		095720801
M	51,00		095720802
L	51,00		095720803
XL	51,00		095720804
XXL	51,00		095720805

9510W
camicia uomo elasticizzata a manica lunga, 120 g/m2 97% cotone, 3% elastan. Bianca, con logo nero. Carrè posteriore con due pieghe laterali, colletto semi francese. Bottoni bianchi, due bottoni al polsino. Vestibilità slim



Dimensione	€	Icona	Articolo
XS	118,00		095100100
S	118,00		095100101
M	118,00		095100102
L	118,00		095100103
XL	118,00		095100104
XXL	118,00		095100105

9534W0
polo 2 bottoni in cotone piqué, 200 g, bianco con inserti arancioni



Dimensione	€	Icona	Articolo
S	67,00		095340031
M	67,00		095340032
L	67,00		095340033
XL	67,00		095340034
XXL	67,00		095340035

9534B0
polo 2 bottoni in cotone piqué, 200 g, blu con inserti grigi



Dimensione	€	Icona	Articolo
S	67,00		095340071
M	67,00		095340072
L	67,00		095340073
XL	67,00		095340074
XXL	67,00		095340075

9537TL
pile 100% poliestere
DISPONIBILE FINO AD ESAURIMENTO SCORTE



Dimensione	€	Icona	Articolo
S	64,00		095370051
M	64,00		095370052
L	64,00		095370053
XL	64,00		095370054
XXL	64,00		095370055



9580S

occhiali da sole, modello "Summer"

CE



EN ISO 12312-1:2013+A1:2015
UV400
FILTER CAT. III

9580S € 35,50 1 095800100

9593S

smartwatch, touchscreen, fitness tracker, cinturino in silicone



9593 S € 153,00 1 095930200

9593SB

smart bracelet, touchscreen, fitness tracker, multifunzione, con cardiofrequenzimetro, contapassi, monitoraggio del sonno, con cinturino in silicone, nero

Compatibilità: IOS 8.2 o superiori/ Android 4.4 o superiori
Bluetooth 4.2
IP67

CE



IP67

9593SB € 112,50 1 095930205

9593M

orologio con movimento automatico, cassa in acciaio, water resistant 5 ATM, cinturino in acciaio



9593M € 372,00 1 095930120

9593A

cronografo, cassa in acciaio, water resistant 5ATM, cinturino in silicone



9593A € 295,00 1 095930050

9593W

orologio analogico, cassa in plastica soft touch con ghiera in metallo, water resistant 3ATM, cinturino in silicone



9593W € 65,00 1 095930150



9544C

trolley dimensioni formato cabina con 4 ruote doppie, lucchetto TSA, porta USB + jack 3,5 mm



9544C L 40 cm S 20 cm H 55 cm € 153,50 1 095440101

9557J 2.0

borsone in poliestere spalmato/poliestere oxford 600D, dimensioni 47x28x25 cm



9557J 2.0 L 47 cm S 25 cm H 28 cm € 91,50 1 095570020

9541F

zaino in poliesterne spalmato/poliesterne oxford 600D, dimensioni 50x33x16 cm



	L cm	S cm	H cm	€		
9541F	33	16	50	86,00	1	095410011

9541PC

zaino da lavoro multitasche, con tasca interna porta computer, in 100% poliesterne

- zaino con 3 scomparti, tutti con zip esterna waterproof
- primo scomparto con tasca porta PC
- maniglia superiore imbottita
- presa USB
- tasca laterale a rete porta borraccia/ombrello
- inserto porta-occhiali su spallaccio
- cinghia al petto regolabile



	L cm	S cm	H cm	€		
9541PC	34	18	52	74,50	1	095410041

9541S

zainetto con coulisse in poliesterne 210D impermeabile cm 33x45



	L cm	H cm	€		
9541S	33	45	11,60	1	095410031

9541BIKE

zainetto in poliesterne oxford, dimensioni 41x24x16 cm



	L cm	S cm	H cm	€		
9541BIKE	24	16	41	20,40	1	095410021

95740

guanto da lavoro, con polsino elastico elasticizzato, pollice ed indice rinforzati, in pelle sintetica che consente l'uso di dispositivi touchscreen

CE



	€		
M	39,50	1	095740202
L	39,50	1	095740203
XL	39,50	1	095740204
XXL	39,50	1	095740205

9574B

guanto da lavoro, con polsino elastico elasticizzato, pollice ed indice rinforzati, in pelle sintetica che consente l'uso di dispositivi touchscreen

CE



	€		
M	39,50	1	095740102
L	39,50	1	095740103
XL	39,50	1	095740104
XXL	39,50	1	095740105

9525CM

cappellino racing camouflage con visiera piatta, 100% poliesterne, fori posteriori e snapback



	€		
9525CM	25,00	1	095250098

9525TR

cappellino trucker nero con visiera curva, 50% cotone 50% poliesterne, rete nella parte posteriore e snapback



	€		
9525TR	25,00	1	095250011

9525WB

cappellino da baseball bianco con visiera curva, 100% poliesterne, fori sulla calotta e chiusura con cinturino



	€		
9525WB	17,70	1	095251032

9520P

portaombrelli in metallo zincato, con logo tagliato a laser, con vaschetta salvagoccia, nero



	€		
9520P	70,50	1	095200100

9521

ombrello in nylon T210 con fusto in alluminio, nero, 3 sezioni, automatico



	€		
9521	32,50	1	095210000

95210B

ombrello in nylon 210T, diametro 100 cm



95210B	Ø cm 100	€ 36,00	1	095210021
--------	----------------	------------	---	-----------

9599CB-N2

city bike Atala®, telaio in Hi-Ten Tig TKK 700c, cambio Shimano® Tourney RD-TZ50 6 velocità, freni V-brake®, cerchi in alluminio 28", dotata di portapacco, cavalletto e campanello, nero opaco



9599CB-N2	€ 680,00	1	095990031
-----------	-------------	---	-----------



9599CB-WN

city bike Atala®, telaio in alluminio, cambio Shimano® 6 velocità, freni V-Brake® cerchi in alluminio 28", grigio

• Telaio in alluminio • Forcella Hi-Ten Tig TKK 700c • Cambio Shimano Tourney RD-TZ50 6s • Freni alluminio V-brake • Cerchi 28" in alluminio, • Colore: grigio



9599CB-WN	€ 680,00	1	095990024
-----------	-------------	---	-----------

9598W-N

mountain bike Whistle®, telaio in alluminio, forcella Suntour XCT30 29" 100 mm, cambio Shimano RD-TX500 7 velocità, freni idraulici Shimano BR-M200 e cerchi 29" in alluminio, arancione fluo/ antracite opaco



9598W M-N	€ 1.161,00	1	095980130
9598W L-N	€ 1.161,00	1	095980132

9598WHP-N

mountain bike Whistle®, telaio in alluminio, forcella Suntour XCM PL 29" 100 mm con remote lockout, cambio Shimano XT RD-M8100 Shadow Plus, 12 velocità, freni idraulici Shimano BL-MT201/BR-MT200 e cerchi 29" in alluminio, bianco/ rosso opaco



9598WHP M-N	€ 2.180,00	1	095980140
9598WHP L-N	€ 2.180,00	1	095980142

9597TRIOWAY

sistema ausiliario di spinta TRIOWAY by ATALA®, elettrico e agganciabile a carrozzina REHA COMFORT (fornita in dotazione), batteria al litio interna al telaio, manubrio con comandi per controllo della direzione e della velocità, con sistema di aggancio alla carrozzina integrato

CE



STRUTTURA

- Sistema di aggancio/sgancio rapido alla carrozzina a leva
- Telaio pieghevole a doppia cerniera
- Manubrio regolabile in altezza
- Freno a disco da 180 mm
- Luce a LED anteriore
- Ruota anteriore con copertone in gomma

PRESTAZIONI

- Velocità regolabile fino a un massimo di 15 km/h
- Tasto di marcia avanti e retromarcia
- Autonomia 20 km
- Acceleratore a leva sul manubrio

ACCESSORI

- Display multifunzione, con indicazione di batteria residua e stato di ricarica
- Campanello
- Indicatori di direzione
- Portacellulare, fornito in dotazione
- Pulsante di accensione e spegnimento
- SISTEMA DI AGGANCIAMENTO RAPIDO SOTTO CARROZZINA già installato

CARROZZINA REHA COMFORT in dotazione

- Telaio pieghevole a doppia cerniera
- Ruote 24" con copertone PU pieno
- Braccioli estraibili
- Pedane estraibili e regolabili
- Seduta in nylon con tasca posteriore

BATTERIA

- Batteria litio ricaricabile 7Ah
- Batteria inserita nel telaio, estraibile
- Cavo di ricarica 230V 50Hz, fornito in dotazione



9597TRIOWAY

€ 2.300,00	1	095970200
---------------	---	-----------



9539CB

casco di protezione per ciclismo su strada e mountain bike con frontino removibile - taglie regolabili



taglia	€	quantità	codice
S-M	179,50	1	095390010
L-XL	179,50	1	095390011

9542M

maglia maniche corte in microfibra traspirante, zip lunga coperta, tre tasche posteriori di cui 1 con zip, elastico in silicone a fondo maglia



taglia	€	quantità	codice
S	128,00	1	095420051
M	128,00	1	095420052
L	128,00	1	095420053
XL	128,00	1	095420054
XXL	128,00	1	095420055
XXXL	128,00	1	095420056

9542C

salopette in lycra, elastico siliconato fondo gamba, fondello antibatterico ad alta traspirabilità



taglia	€	quantità	codice
S	122,00	1	095420061
M	122,00	1	095420062
L	122,00	1	095420063
XL	122,00	1	095420064
XXL	122,00	1	095420065
XXXL	122,00	1	095420066

9542GW

giubbino invernale realizzato in tessuto antivento ad alta traspirabilità e in tessuto garzato; zip lunga, fascia elastica in vita senza silicone; polsino aderente in Lycra; inserti rifrangenti posteriori; 3 tasche esterne posteriori, di cui 1 con zip



taglia	€	quantità	codice
S	221,50	1	095420101
M	221,50	1	095420102
L	221,50	1	095420103
XL	221,50	1	095420104
XXL	221,50	1	095420105
XXXL	221,50	1	095420106

9542G

maglia invernale in tessuto traspirante, garzato internamente, zip lunga, tre tasche posteriori, elastico in silicone a fondo maglia



taglia	€	quantità	codice
S	127,50	1	095420012
M	127,50	1	095420013
L	127,50	1	095420014
XL	127,50	1	095420015
XXL	127,50	1	095420016
XXXL	127,50	1	095420017



9542S

calzamaglia in lycra garzata con fondello antibatterico ad alta traspirabilità



taglia	€	quantità	codice
S	171,50	1	095420022
M	171,50	1	095420023
L	171,50	1	095420024
XL	171,50	1	095420025
XXL	171,50	1	095420026
XXXL	171,50	1	095420027

9542AT

gilet antivento in tessuto accoppiato traspirante, zip lunga



taglia	€	quantità	codice
S	103,00	1	095420072
M	103,00	1	095420073
L	103,00	1	095420074
XL	103,00	1	095420075
XXL	103,00	1	095420076
XXXL	103,00	1	095420077

9542AL

giubbino antivento in tessuto accoppiato traspirante, zip lunga



	€		
S	164,00	1	095420042
M	164,00	1	095420043
L	164,00	1	095420044
XL	164,00	1	095420045
XXL	164,00	1	095420046
XXXL	164,00	1	095420047

9543C

copricollo tubolare, multifunzione, 100% microfibra di poliestere, senza cuciture



	L cm	H cm	€		
9543C	25	50	9,00	1	095430100

9523T

borraccia termica in acciaio inox, 500 ml, tecnologia doppio strato, senza aria tra le pareti, tappo antigoccia arancione

- 24 ore fresco
- 12 ore caldo



EC1935/EC2023

	ml	L mm	€		
9523T	500	255	22,50	1	095230050

9528B

borraccia in polietilene, 500ml



	ml	€		
9528B	500	7,10	1	095280005

9597P

pompa a colonna con manometro

- adattatore per il gonfiaggio di qualsiasi tipo divalvola (Schrader, Presta/Sclaverand, Regina)
- Max 12 bar/ 180psi



	€		
9597P	66,00	1	095970100

9524SC

garage Beta in miniatura per collezionisti



	€		
1:18	94,00	1	095240018

9548KB

balance bike, telaio in acciaio e ruota 12" con camera d'aria, età consigliata: + 3 anni, peso massimo < 30 kg



	€		
9548KB	170,50	1	095480110

9548KB 20

mountain bike da bambino Atala® 20", telaio in acciaio Hi-Ten Tig 20", forcella ammortizzata 30 mm, cambio Shimano Tourney RD-TY21SS 6V, freni in alluminio V-brake e cerchi in alluminio, 36 fori, giallo fluo/ blu opaco



	€		
9548KB 20	550,00	1	095480120

9548KB 24

mountain bike da bambino Atala® 24", telaio in acciaio Hi-Ten Tig 24", forcella ammortizzata, cambio Shimano Tourney RD-TYZ50 6V, freni in alluminio V-brake e cerchi in alluminio, 36 fori, arancio fluo opaco



	€		
9548KB 24	585,00	1	095480122

9547WSK

"Kinder Work Station", banco da lavoro con utensili per bambini a partire da 3 anni

CE



	H cm	€		
9547WSK	74	127,50	1	095473801

9547T

"Kinder trolley", carrello attrezzi con utensili per bambini a partire da 3 anni

CE



	€		
9547T	69,50	1	095470100



9548G

"Kinder Garage" a 6 piani, con autolavaggio, ascensore e rampe



9548 G	H cm	69	€	69,50	1	095480100
--------	---------	----	---	-------	---	-----------

9561V 2,5

bandiera a vela mt 2,5x0,50
con asta in alluminio
basamento a croce completo di zavorra a
ciambella



9561V 2,5	L mt	0,50	H mt	2,5	€	250,00	1	095610200
-----------	---------	------	---------	-----	---	--------	---	-----------

9561VV 2,5

bandiera a vela mt 2x0,50
con asta



9561VV 2,5	L mt	0,50	H mt	2,5	€	224,50	1	095610201
------------	---------	------	---------	-----	---	--------	---	-----------

9561VV

bandiera a vela mt 3,50x0,75
con asta



9561VV 4,0	L mt	0,75	H mt	3,50	€	370,00	1	095610101
------------	---------	------	---------	------	---	--------	---	-----------

9561V

bandiera a vela mt 4x0,75
con asta in metallo cromato
basamento in graniglia di cemento 50 cm



9561V	L mt	0,75	H mt	4	€	646,00	1	095610001
-------	---------	------	---------	---	---	--------	---	-----------

9559

striscione monofacciale in TNT,
modulo da 3x0,8 m o multipli



9559	L m	3	H m	0,8	€	30,00	1	095591001
------	--------	---	--------	-----	---	-------	---	-----------

9559/30MT

rotolo 10 loghi Beta in TNT



9559/30MT	€	283,00	1	095591031
-----------	---	--------	---	-----------

9590B

bandiera in nylon serigrafato
140x215 cm



9590B	L cm	215	H cm	140	€	127,50	1	095900000
-------	---------	-----	---------	-----	---	--------	---	-----------



9577R

tuta da lavoro, **stile racing**, in tessuto
elasticizzato, 4 way stretch, 260 g,
nero e arancione, con inserti bianchi e reflex

CE



		€	1	
S	48	152,00	1	095770151
M	50	152,00	1	095770152
L	52	152,00	1	095770153
XL	54	152,00	1	095770154
XXL	56	152,00	1	095770155
XXXL	58	152,00	1	095770156

9579C

camice in poliestere/cotone



		€	1	
M		67,00	1	095791002
L		67,00	1	095791003
XL		67,00	1	095791004

9565T

tavolo in lamiera d'acciaio con piano in legno multistrato di betulla verniciato.

Fornito con doppio KIT di tubi distanziali (7 o 20 cm) per regolare l'altezza a piacere.



9565T	H cm	Ø cm	€	1	095650200
	95→108	70	500,00		

9565S

seduta in lamiera d'acciaio con sedile in ecopelle sfoderabile



9565S	H cm	Ø cm	€	1	095650300
	60	38	219,00		

9565K

tavolo 9565T con due sedute 9565S



9565K	€	1	095650500
	938,00		



9563G

poltrone per ufficio, per ospiti



9563G	€	1	095630050
	186,00		

9563U

poltrona per ufficio, ergonomica, con braccioli



9563U	€	1	095630020
	367,00		

9549ABW

auricolari Wireless Bluetooth V5.0, con microfono integrato, ricarica magnetica, base di ricarica con attacco USB-C, nero

CE



9549ABW	L mm	H mm	S mm	€	1	095490091
	61	34,5	41	33,50		

9549SBW

speaker BT wireless, portatile, 6 funzioni

versione BT 5.0

FUNZIONI:

- BT play
- TF card play
- USB play
- audio jack 3.5 mm
- radio FM
- funzione chiamata

CE



9549SBW	L mm	S mm	H mm	€	1	095490072
	73	73	124	46,50		

9549BP

batteria portatile, 10000mAh



9549BP	€	1	095490052
	23,90		

9549CR

multicavo di ricarica 4 in 1, in nylon intrecciato, con carica rapida

- USB tipo-A per connessione dell'alimentatore

- Lightning per connessione modelli Apple
- Micro USB connettore di ricarica
- USB-C connettore per sola ricarica
- USB-C connettore per ricarica e trasmissione dati



9549CR	L mm	€	1	095490042
	120	17,90		

9549MPC

base di ricarica multi-presa, 6 porte USB per ricarica multipla fino a potenza assorbita massima di 65W

- 4 porte USB, 5V 2.4A
- 1 porta USB, Q.C 3.0
- 1 porta USB-C, 20W PD

con interruttore ON/OFF separato con schermo LED per verificare potenziale totale, numero della porta e intensità di corrente

CE



9549MPC	L mm	S mm	H mm	€	1	095490082
	110	72	35	57,00		

9549BRW

base di ricarica wireless, con funzione **quick charger** e **indicatore dello stato di carica**

- Cavo USB-USB Type C incluso, per collegamento a trasformatore, lunghezza 1 mt
- Compatibile con tutti i dispositivi abilitati alla ricarica wireless
- Input: DC 5V/2A, 9V/2A, 12V/1.5A
- Output: 5W/ 7.5W/ 10W/ 15W

CE



9549BRW	Ø mm	H mm	€	1	095490100
	58	6	32,50		

9549C

chiavetta USB, 32GB



9549C	€	1	095490062
	21,10		

9547

calcolatrice da tavolo

CE



9547	€	1	095470000
	21,20		

9594

orologio da parete dotato di termometro ed igrometro, diametro 26 cm



9594	Ø cm	€	1	095940051
	26	31,50		

9526F

mini frigorifero, classe di efficienza energetica F, capacità di 65 litri, nero

CE



9526F	€	1	095260005
	551,00		

9526P

macchina per caffè espresso a capsule

compatibile con cialde Lavazza™, Espresso Point™ per uso professionale



9526P	€	1	095260010
	360,00		

9527 6T

set 6 tazzine caffè



9527 6T	€	1	095270001
	103,00		

9522A

apribottiglie con impugnatura ergonomica



9522A	€	1	095220010
	18,00		

9523A

borraccia in alluminio, 500ml



9523A	ml	€	1	095230005
	500	12,40		

9586K

coltellino multiuso in acciaio, 10 funzioni



9586K	€	1	095860100
	17,30		

9526RMN

set 2 mazzi di 55 carte ramino Modiano®



9526RMN	€	1	095260001
	30,00		

9592B/C50

set 50 penne



9592B/C50	€	1	095920050
	51,50		

9592B/P

penne personalizzate



9592B/P	€	500	095920051
	1,54		

9592MB

penna a sfera Parker®



9592MB	€	1	095920060
	83,50		

Beta
Quality tools

9592M/50
set 50 matite



9592M/50 € 51,50 1 095920100

9588M

termoformato morbido con 1 penna e 2 block notes



9588M € 21,80 1 095880011

9596

portabadge in poliestere con moschettone in metallo e filo portatelefono



9596 € 5,20 10 095961001

9595C

portachiave in pelle



9595C € 9,40 1 095950011



9595T

portachiave in metallo cromato, in bustina di velluto



9595T € 7,90 1 095950021

9569P

shopper in polietilene, con soffiotti laterali



9569P L cm 34 H cm 44 € 0,84 50 095691001

9569S

shopper in TNT con soffietto, 38x42 cm



9569S L cm 38 H cm 42 € 2,57 50 095690051

9569MS-2

shopper in polipropilene, ad alta resistenza



9569MS-2 L cm 45 H cm 40 € 6,80 5 095690055

9569MS

shopper in polipropilene, ad alta resistenza, con doppi manici



9569MS L cm 60 H cm 40 € 6,80 5 095690052

9587 9x14

taccuino, 9x14 cm



9587 9X14 L cm 9 H cm 14 € 14,00 5 095870009

9587 13x21

taccuino, 13x21 cm



9587 13X21 L cm 13 H cm 21 € 17,90 5 095870013



9588S/10...

set di 10 block notes



9588S/10A 21x29 cm	€ 30,00	1	095881001
9588S/10B 15x21 cm	€ 28,50	1	095881002
9588S/10C 10x15 cm	€ 18,60	1	095881003
9588S/10D 7,5x10,5 cm	€ 13,40	1	095880054

9588/10PI

set di 10 blocchetti per appunti con loghi adesivi



9588S/10PI 7,5x7,5 cm	€ 28,00	1	095880055
--------------------------	---------	---	-----------

9589A/36

confezione da 36 rotoli di nastro adesivo per imballo, logo Beta, avana



9589A/36	€ 144,00	1	095890035
----------	----------	---	-----------

9589B/36

confezione da 36 rotoli di nastro adesivo per imballo, logo Beta, bianco



9589B/36	€ 144,00	1	095890036
----------	----------	---	-----------

9562TB

tappeto prova calzature, con retro gommato antiscivolo



9562TB	L mm 800	H mm 600	€ 49,50	1	095620500
--------	----------	----------	---------	---	-----------

9562T2

tappeto per banco da lavoro 200x160 cm

- protegge il suolo da perdite d'olio, benzina e rispetta l'ambiente
- facile da pulire, fondo gommato ed antiscivolo

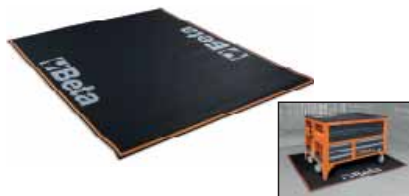

9562T2	L cm 200	H cm 160	€ 247,50	1	095620200
--------	----------	----------	----------	---	-----------

9562T1

tappeto da officina 100X80 cm

- particolarmente indicato per l'utilizzo sotto smontagomme per moto BETA 3071 e 3071B
- facile da pulire, fondo gommato e antiscivolo



9562T1	L cm 100	H cm 80	€ 91,00	1	095620150
--------	----------	---------	---------	---	-----------

9562T3

tappeto da officina 300x160 cm

- particolarmente indicato per l'utilizzo sotto ponti sollevatori moto
- protegge il suolo da perdite d'olio, benzina e rispetta l'ambiente
- facile da pulire, fondo gommato e antiscivolo



9562T3	L cm 300	H cm 160	€ 360,00	1	095620300
--------	----------	----------	----------	---	-----------

9562P2

tappeto con logo BETA 200x80 cm

- particolarmente indicato per utilizzi con arredo officina C55, C45 o come tappeto sottomoto
- protegge il suolo da perdite d'olio, benzina e rispetta l'ambiente
- facile da pulire, fondo gommato ed antiscivolo



9562P2	L cm 200	H cm 80	€ 173,50	1	095620400
--------	----------	---------	----------	---	-----------

9562P12

rotolo tappeto multi logo 12 m x 80 cm

- permette di personalizzare la lunghezza del tappeto in base alle esigenze dell'utilizzatore
- protegge il suolo da perdite d'olio, benzina e rispetta l'ambiente
- facile da pulire, fondo gommato ed antiscivolo



9562P12	L m 12	H cm 80	€ 876,00	1	095620425
---------	--------	---------	----------	---	-----------



SERVIZIO DI TARATURA DINAMOMETRIA

Beta Utensili SpA dispone di attrezzature certificate **Accredia (LAT)** per la taratura di chiavi dinamometriche fino a 2000 Nm, in conformità alla norma **UNI EN ISO 6789:2017**.

Presso il Laboratorio Beta è possibile eseguire la calibrazione dei seguenti articoli:



Chiavi a slittamento, a disinnesto o scatto



Giravite dinamometrici



Chiavi non graduate

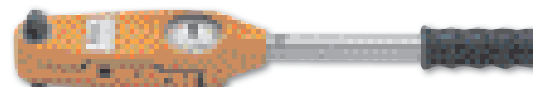

Chiavi a lettura



Chiavi digitali



Dynatester

Per alcune chiavi dinamometriche è possibile richiedere la certificazione destrorsa, sinistrorsa o entrambe. La norma prevede un controllo su tre punti con cinque campionamenti per punto.

E' possibile inoltre richiedere certificazioni Accredia di chiavi e Dynatester, sarà nostra cura verificarle e mandarle al centro accreditato che rilascerà il certificato.

La validità dei certificati, secondo quanto previsto dalla norma UNI EN ISO 6789 è pari a 5.000 cicli oppure un anno. Sulle chiavi nuove la validità del certificato parte dal primo utilizzo.

Valore osservato (per Purpose)		Valori osservati, serie di applicazioni cicliche, serie di misura circolarmente misurata (static, unidirectional, bidirectional, Accurately one measurement)					Valore medio (Mean Value)	Incertezza relativa (Relative Uncertainty)	Intervallo (range)
Nm	(K)	(K)	(K)	(K)	(K)	(K)	% (k=2)	% (k=2)	
40 ± 1.3%	41.06 -2.58 %	40.90 -2.21 %	40.87 -2.13 %	40.94 -2.30 %	41.02 -2.49 %	40.96	1,115	3,727	
120 ± 1.3%	116.19 1.53 %	117.97 1.72 %	117.82 1.80 %	117.76 1.90 %	117.73 1.90 %	117.89	0,480	2,516	
200 ± 1.3%	199.97 0.02 %	200.21 -0.11 %	200.22 -0.11 %	200.16 -0.08 %	200.02 -0.01 %	200.12	0,320	0,647	

Massimo errore relativo (as% max) -2,58 %. Sulla base dei valori osservati, l'utensile dinamometrico identificato in questo documento risulta **CONFORME** alla norma **ISO 6789-2:2017**.
Maximum tolerance limit (as% max) -2,58 %. Based on the observed values, the torque tool identified in this document result **CONFORME** with standard **ISO 6789-2:2017**.

La strumentazione utilizzata per la calibrazione ha una intracciabilità internazionale attraverso un laboratorio di calibrazione accreditato secondo la ISO 17025.
The test equipment used in the performance of the above calibration has international traceability through a calibration laboratory accredited to ISO 17025.

La strumentazione ha un errore relativo max (dep) di **0,250%**, che è inferiore a 1% della massima deviazione permessa sull'utensile in un intervallo di incertezza relativa (11mcd) di **0,225%**.
The torque measurement device has a maximum relative measurement error (dep) of **0,250%**, is therefore less than 1% of the maximum permissible relative deviation of the torque tool and relative measurement uncertainty interval (11mcd) of **0,225%**. The maximum relative measurement error.

Modello Tester / n° serie Tester Model / serial no.	BA-250 / 125648	Certificato Tester n° Cert Tester No.	LAT 267-23A5078
--	-----------------	--	-----------------

Data: 26/10/2023 Operatore calibrazione: TA Castellano Responsabile Qualità: F. Sacchet
Date: Calibration inspector: Quality Manager:

Per usufruire di questo servizio rivolgeti al tuo rivenditore di fiducia

ARTICOLI ELIMINATI - ARTICOLI SOSTITUTIVI/CONSIGLIATI

	ARTICOLO ELIMINATO
	ARTICOLO SOSTITUTIVO
	ARTICOLO CONSIGLIATO

96AS 5/8	000960736		
96AS 3/4	000960738		
97BTX 50	000970150		
97BTX 55	000970155		
98XZN 14	000980014		
98XZN 16	000980016		
310/1	003100001		
310/C4	003100104		
353N	003530201		
353NM 10	003530210		
353NM 12	003530212		
353NM 14	003530214		
353NM 16	003530216		
353NM 18	003530218		
353NM 22	003530222		
353N/C6	003530300		
386A/3	003860003	386A/1	003860001
386A/4	003860004	386A/2	003860002
386A3/RC	003860013	386A1/RC	003860011
386A4/RC	003860014	386A2/RC	003860012
412 C3.00	004120288		
412 C3.25	004120289		
412 C3.50	004120290		
412 C4.00	004120292		
412 C4.50	004120294		
412 C5.00	004120296		
412 C5.50	004120298		
412 C6.00	004120300		
412 C6.50	004120301		
412 C7.00	004120302		
412 C7.50	004120303		
412 C8.00	004120304		
415 C3.00	004150288		
415 C3.25	004150289		
415 C3.50	004150290		
415 C4.00	004150292		
415 C4.50	004150294		
415 C5.00	004150296		
415 C5.50	004150298		
415 C6.00	004150300		
415 C6.50	004150301		
415 C7.00	004150302		
415 C7.50	004150303		
415 C8.00	004150304		
420A M3	004200003		
420A M4	004200004		
420A M5	004200005		
420A M6	004200006		
420A M8	004200008		
420A M10	004200010		
420B M3	004200053		
420B M4	004200054		
420B M5	004200055		
420B M6	004200056		
420B M8	004200058		
420B M10	004200060		
437K/10	004370030		
666N/2	006660002	666/2	006660702
666N/2X	006660003	666/2X	006660703
666N/5	006660005	666/5	006660705
666N/10	006660010	666/10	006660710
666N/10X	006660011	666/10X	006660711
666N/20	006660020	666/20	006660720
666N/30	006660030	666/30	006660730
666N-LBF.IN/5	006660055		
666N-LBF.IN/10	006660070		

666N-LBF.IN/10X	006660071		
666N-LBF.IN/20	006660072		
666N-LBF.IN/30	006660073		
666HS/5	006664005	666ZR-HS/5	006664705
666HS/10	006664010	666ZR-HS/10	006664710
		666ZR-HS/20LC	006664721
666HS/20LC	006664021		
		666ZR-HS/30LC	006664731
666HS/30LC	006664031		
667N/20	006670020	667/20	006670720
667N/30	006670030	667/30	006670730
667N/40	006670040	667/40	006670740
956L 20.8	009560221		
960S 22	009600022		
960T/D	009600035		
960T/E	009600036		
960T/I	009600040		
960T/L	009600041		
960T/M	009600042		
960BT/B 29	009600128		
960AVL	009600210		
960CMB	009600250		
960CMB/R2	009600252		
960CMD	009600270		
960CMD/R1	009600271		
960BC 25	009600285		
960BC 27	009600287		
960BC/P 28	009600288		
960BC 29	009600289		
960BC 30	009600290		
960EPC	009600790		
960SN 11	009600837		
960SN 12	009600838		
1044F 250	010440015	1044N 250	010440025
1044 250	010440025	1044N 250	010440025
1044FK 250	010449015	1044NK 250	010449025
1044K 250	010449250	1044NK 250	010449025
1134A/RL	011340145		
1150MQ 160	011500096	1150MQ 160	011500496
1150MQ 180	011500098	1150MQ 180	011500498
1150MQ 200	011500100	1150MQ 200	011500500
1150MQ 220	011500102	1150MQ 220	011500502
1229LP 1.0	012290210		
1229LP 1.2	012290212	1257LP 1.2	012570012
1229LP 1.4	012290214		
1229LP 1.8	012290218	1257LP 1.8	012570018
1229LP 2.0	012290220	1257LP 2.0	012570020
1229LP 2.4	012290224		
1229LP 3.0	012290230	1257LP 3.0	012570030
1229PH 0	012290250	1257PH 0	012570063
1229PH 1	012290251	1257PH 1	012570066
1366S	013660000	1366SH	013660400
1366S-KIT	013660001		
1438DCT	014380300		
1461/C5G	014610053		
1461/C6B	014610063		
1461/C6G	014610064		
1461/C7B	014610072		
1461/C8B	014610083		
1461/C9B	014610092		
1461/C11A	014610111		
1461/C12A	014610123		
1461/C13B	014610134		
1461/C18B	014610182		
1461/C29B	014610209		
1461/C20G	014610221		
1461/C21G	014610222		
1461/C23B	014610224		
1461/C24B	014610225		
1461/C25G	014610226		
1461/C27G	014610228		
1461/C28B	014610229		
1461/C30G	014610231		

1461/C32G	014610233		
1461/C33B	014610234		
1462/KD	014620060		
1462/KMRC	014620070		
1462PIM	014620502		
1468N/1	014680011		
1468N/2	014680012		
1468N/3	014680013		
1478/3P	014780151		
1486/10	014860110		
1486/20	014860120		
1486/30	014860130		
1486/40	014860140		
1486/50	014860150		
1486/60	014860160		
1486/70	014860170		
1486/80	014860180		
1486/90	014860190		
1493 68-L14	014930206		
1493 75/77-L15	014930212		
1493 76-L8	014930214		
1493 95-L15	014930244		
1493AL 94,5-L15	014930345		
1493AL/CF 27	014930427		
1498TC	014980450		
1696A 800	016960108		
1716Q	017160010		
1739B	017390151	1739C	017390152
1740A	017400101	1740AN	017400103
1742	017420001	1742N	017420002
1742/C4	017420005	1742N/C4	017420006
1742KR M3	017420043	1742N/KR M3	017420063
1742KR M4	017420044	1742N/KR M4	017420064
1742KR M5	017420045	1742N/KR M5	017420065
1742KR M6	017420046	1742N/KR M6	017420066
1742A	017420100	1742AN	017420101
1742A/C	017420105	1742AN/C	017420106
1742A/KR M5	017420143	1742AN/KR M5	017420155
1742A/KR M6	017420144	1742AN/KR M6	017420156
1742A/KR M8	017420145	1742AN/KR M8	017420158
1742A/KR M10	017420146	1742AN/KR M10	017420160
1751NR	017510110		
1752 700	017520007		
1752R	017520020		
1753 200	017530002		
1753 300	017530003		
1753 500	017530005		
1753 700	017530007		
1753R	017530020		
1755 30	017550003		
1755 80	017550008		
1755 150	017550015		
1834RR	018340520		
1840BM	018400101		
1882	018820010	1882N	018820110
1883	018830035	1883N	018830036
1889	018890200	1889N	018890220
1915B 11X16	019150013		
1915C 11X16	019150016		
1915D 11X16	019150018		
1927PAL	019270009		
1946T	019460021	1946	019460001
1949BC/RU	019490122	1949BC/RUL	019490123
1972/H2	019720012	1972/K12V-10	019720112
1984/18QM	019840018	1984/K600	019840060
2009ID	020091013	2109MT ID/1	021091026
2032TEL/A	020321314		
2051N	020510215	2051N	020510225
2258-O	022580011	2258N-O	022580021
TV250	024000408		
TV290	024000455	TV294	024000491
TV255	024000467		

ARTICOLI ELIMINATI - ARTICOLI SOSTITUTIVI/CONSIGLIATI

	ARTICOLO ELIMINATO
	ARTICOLO SOSTITUTIVO
	ARTICOLO CONSIGLIATO

TV79	024000490		
TV121	024000767	TV122	024000768
T13	024240013		
T53	024240053		
T57	024240057		
T79	024240079		
T121	024240121	T122	024240122
T250	024240250		
T256	024240256		
T285	024240285	T279	024240279
T289	024240289	T294	024240294
T289	024240289	M294	024500294
TV57	024249907		
TV13	024249913		
M285	024500285		
M289	024500289		
MV115	024510115	MV116	024510116
MV285	024510285		
MV289	024510289	MV294	024510294
MM61	024580061		
MM140	024580141		
MMV61	024590061		
MMV142	024590142		
3008	030080100	3008N	030080110
3025	030250001	3025N 1,0	030250110
3025/PF	030250011	3025N/PF	030250111
3025/RF	030250901		
3025/RG	030250902		
3027 10	030270010	3027N 10	030270101
3027 20	030270020	3027N 20	030270102
3027 30	030270030	3027N 30	030270103
3027 50	030270050	3027N 50	030270105
3027 100	030270100	3027N 100	030270110
3027/KP10	030270510	3027N/KP10-20	030270511
3027/KP20	030270520	3027N/KP10-20	030270511
3027/KP30	030270530	3027N/KP30	030270531
3027/KP50	030270550	3027N/KP50	030270541
3027/KP100	030270551	3027N/KP100	030270552
3027/KPP50	030270555	3027N/KPP50	030270565
C45LMP	045000320	5000 RSC50/PLED	050001714
C54S-G	054000302		
C54S-R	054000303		
C55C	055000400		
C58M/PA	058000350		
5910VG/3T	059101068		
5945VU/M	059451001	5945VUM	059451011
5980ID	059801085	5980ID/1	059801086
C62M/W	062000360	C62M/WW	062000362
6200M/B	062000361		
7195A	071950004		
7200BKK 35	072000235		
7200BKK 36	072000236		
7200BKK 37	072000237		
7200BKK 38	072000238		
7200BKK 39	072000239		
7200BKK 40	072000240		
7200BKK 41	072000241		
7200BKK 42	072000242		
7200BKK 43	072000243		
7200BKK 44	072000244		
7200BKK 45	072000245		
7200BKK 46	072000246		
7200BKK 47	072000247		
7200BKK 48	072000248		
7201BKK 35	072010435		
7201BKK 36	072010436		

7201BKK 37	072010437		
7201BKK 38	072010438		
7201BKK 39	072010439		
7201BKK 40	072010440		
7201BKK 41	072010441		
7201BKK 42	072010442		
7201BKK 43	072010443		
7201BKK 44	072010444		
7201BKK 45	072010445		
7201BKK 46	072010446		
7201BKK 47	072010447		
7201BKK 48	072010448		
7210BKK 35	072100335		
7210BKK 36	072100336		
7210BKK 37	072100337		
7210BKK 38	072100338		
7210BKK 39	072100339		
7210BKK 40	072100340		
7210BKK 41	072100341		
7210BKK 42	072100342		
7210BKK 43	072100343		
7210BKK 44	072100344		
7210BKK 45	072100345		
7210BKK 46	072100346		
7210BKK 47	072100347		
7210BKK 48	072100348		
7212LG 34	072120134		
7212LG 35	072120135		
7212LG 36	072120136		
7212LG 37	072120137		
7212LG 38	072120138		
7212LG 39	072120139		
7212LG 40	072120140		
7212LG 41	072120141		
7212LG 42	072120142		
7214LN 34	072140134		
7214LN 35	072140135		
7214LN 36	072140136		
7214LN 37	072140137		
7214LN 38	072140138		
7214LN 39	072140139		
7214LN 40	072140140		
7214LN 41	072140141		
7214LN 42	072140142		
7216BKK 35	072160335		
7216BKK 36	072160336		
7216BKK 37	072160337		
7216BKK 38	072160338		
7216BKK 39	072160339		
7216BKK 40	072160340		
7216BKK 41	072160341		
7216BKK 42	072160342		
7216BKK 43	072160343		
7216BKK 44	072160344		
7216BKK 45	072160345		
7216BKK 46	072160346		
7216BKK 47	072160347		
7216BKK 48	072160348		
7224PEK 35	072240235		
7224PEK 36	072240236		
7224PEK 37	072240237		
7224PEK 38	072240238		
7224PEK 39	072240239		
7224PEK 40	072240240		
7224PEK 41	072240241		
7224PEK 42	072240242		
7224PEK 43	072240243		
7224PEK 44	072240244		
7224PEK 45	072240245		
7224PEK 46	072240246		
7224PEK 47	072240247		

7224PEK 48	072240248		
7225PEK 35	072250135		
7225PEK 36	072250136		
7225PEK 37	072250137		
7225PEK 38	072250138		
7225PEK 39	072250139		
7225PEK 40	072250140		
7225PEK 41	072250141		
7225PEK 42	072250142		
7225PEK 43	072250143		
7225PEK 44	072250144		
7225PEK 45	072250145		
7225PEK 46	072250146		
7225PEK 47	072250147		
7225PEK 48	072250148		
7235BK 35	072350335		
7235BK 36	072350336		
7235BK 37	072350337		
7235BK 38	072350338		
7235BK 39	072350339		
7235BK 40	072350340		
7235BK 41	072350341		
7235BK 42	072350342		
7235BK 43	072350343		
7235BK 44	072350344		
7235BK 45	072350345		
7235BK 46	072350346		
7235BK 47	072350347		
7235BK 48	072350348		
7239B 39	072390339		
7239B 40	072390340		
7239B 41	072390341		
7239B 42	072390342		
7239B 43	072390343		
7239B 44	072390344		
7239B 45	072390345		
7239B 46	072390346		
7239B 47	072390347		
7239B 48	072390348		
7248GK 35	072480235		
7248GK 36	072480236		
7248GK 37	072480237		
7248GK 38	072480238		
7248GK 39	072480239		
7248GK 40	072480240		
7248GK 41	072480241		
7248GK 42	072480242		
7248GK 43	072480243		
7248GK 44	072480244		
7248GK 45	072480245		
7248GK 46	072480246		
7248GK 47	072480247		
7248GK 48	072480248		
7293HN 39	072930839		
7293HN 40	072930840		
7293HN 41	072930841		
7293HN 42	072930842		
7293HN 43	072930843		
7293HN 44	072930844		
7293HN 45	072930845		
7293HN 46	072930846		
7293HN 47	072930847		
7294HN 39	072940839		
7294HN 40	072940840		
7294HN 41	072940841		
7294HN 42	072940842		
7294HN 43	072940843		
7294HN 44	072940844		
7294HN 45	072940845		
7294HN 46	072940846		
7294HN 47	072940847		

ARTICOLI ELIMINATI - ARTICOLI SOSTITUTIVI/CONSIGLIATI

	ARTICOLO ELIMINATO
	ARTICOLO SOSTITUTIVO
	ARTICOLO CONSIGLIATO

7310CRK 35	073100335
7310CRK 36	073100336
7310CRK 37	073100337
7310CRK 38	073100338
7310CRK 39	073100339
7310CRK 40	073100340
7310CRK 41	073100341
7310CRK 42	073100342
7310CRK 43	073100343
7310CRK 44	073100344
7310CRK 45	073100345
7310CRK 46	073100346
7310CRK 47	073100347
7310CRK 48	073100348
7340B 36	073400236
7340B 37	073400237
7340B 38	073400238
7340B 39	073400239
7340B 40	073400240
7340B 41	073400241
7340B 42	073400242
7340B 43	073400243
7340B 44	073400244
7340B 45	073400245
7340B 46	073400246
7340B 47	073400247
7341N 36	073410236
7341N 37	073410237
7341N 38	073410238
7341N 39	073410239
7341N 40	073410240
7341N 41	073410241
7341N 42	073410242
7341N 43	073410243
7341N 44	073410244
7341N 45	073410245
7341N 46	073410246
7341N 47	073410247
7349RP 38	073490138
7349RP 39	073490139
7349RP 40	073490140
7349RP 41	073490141
7349RP 42	073490142
7349RP 43	073490143
7349RP 44	073490144
7349RP 45	073490145
7349RP 46	073490146
7349RP 47	073490147
7350RP 38	073500138
7350RP 39	073500139
7350RP 40	073500140
7350RP 41	073500141
7350RP 42	073500142
7350RP 43	073500143
7350RP 44	073500144
7350RP 45	073500145
7350RP 46	073500146
7350RP 47	073500147
7423 39/42	074230002
7423 43/46	074230004
7429 39/42	074290002
7429 43/46	074290004
7635N XS	076350500 7636N XS 076360500
7635N S	076350501 7636N S 076360501
7635N M	076350502 7636N M 076360502
7635N L	076350503 7636N L 076360503

7635N XL	076350504	7636N XL	076360504
7635N XXL	076350505	7636N XXL	076360505
7635N XXXL	076350506	7636N XXXL	076360506
7658N S	076580001		
7658N M	076580002		
7658N L	076580003		
7658N XL	076580004		
7658N XXL	076580005		
7658N XXXL	076580006		
7904N XS	079040800	7750N XS	077500000
7904N S	079040801	7750N S	077500001
7904N M	079040802	7750N M	077500002
7904N L	079040803	7750N L	077500003
7904N XL	079040804	7750N XL	077500004
7904N XXL	079040805	7750N XXL	077500005
7904N XXXL	079040806	7750N XXXL	077500006
7904N XXXXL	079040807	7750N XXXXL	077500007
7907P XS	079070600		
7907P S	079070601		
7907P M	079070602		
7907P L	079070603		
7907P XL	079070604		
7907P XXL	079070605		
7907P XXXL	079070606		
7907P XXXXL	079070607		
7930G XS	079300300	7930MG XS	079300400
7930G S	079300301	7930MG S	079300401
7930G M	079300302	7930MG M	079300402
7930G L	079300303	7930MG L	079300403
7930G XL	079300304	7930MG XL	079300404
7930G XXL	079300305	7930MG XXL	079300405
7930G XXXL	079300306	7930MG XXXL	079300406
7931G XS	079310300	7931MG XS	079310400
7931G S	079310301	7931MG S	079310401
7931G M	079310302	7931MG M	079310402
7931G L	079310303	7931MG L	079310403
7931G XL	079310304	7931MG XL	079310404
7931G XXL	079310305	7931MG XXL	079310405
7931G XXXL	079310306	7931MG XXXL	079310406
7933G XS	079330300	7935MG XS	079350400
7933G S	079330301	7935MG S	079350401
7933G M	079330302	7935MG M	079350402
7933G L	079330303	7935MG L	079350403
7933G XL	079330304	7935MG XL	079350404
7933G XXL	079330305	7935MG XXL	079350405
7933G XXXL	079330306	7935MG XXXL	079350406
7935G XS	079350300		
7935G S	079350301		
7935G M	079350302		
7935G L	079350303		
7935G XL	079350304		
7935G XXL	079350305		
7935G XXXL	079350306		
7939G XS	079390300		
7939G S	079390301		
7939G M	079390302		
7939G L	079390303		
7939G XL	079390304		
7939G XXL	079390305		
7939G XXXL	079390306		
7980N 58	079800058	7981N 58	079810158
7980N 60	079800060	7981N 60	079810160
7980R	079800111	7980RN	079800120
7985	079850111	7985N	079850000
8016FR-6K 3	080169753		
8016FR-4K 5	080169755		
8016FR-4K 6	080169756		
8016FR-4K 8	080169758		
8062 22-25	080620025		
8130A 10X900	081300209		
8131Z-8 6X800	081310060		
8131DL 10X900	081310209		

8135/KCA 0,75	081350630
8135/KCA 1,0	081350635
8135/KCA 2,0	081350640
8135/KCA 3,0	081350645
8135/KCA 5,0	081350650
8135/KGF 0,75	081350705
8135/KGF 1,0	081350710
8135/KGF 2,0	081350720
8135/KGF 3,0	081350730
8135/KGF 5,0	081350750
8135/KGM	081350805
0,75	
8135/KGM 1,0	081350810
8135/KGM 2,0	081350820
8135/KGM 3,0	081350830
8135/KGM 5,0	081350850
8139Z 8	081390008
8139DL 14	081390214
8139ZCH	081390909
8149S/A	081490510
8149S/B	081490512
8149S/C	081490515
9508TL S	095080051
9508TL M	095080052
9508TL L	095080053
9508TL XL	095080054
9508TL XXL	095080055
9515M S	095150051
9515M M	095150052
9515M L	095150053
9515M XL	095150054
9515M XXL	095150055
9515M XXXL	095150056
9516B S	095160051
9516B M	095160052
9516B L	095160053
9516B XL	095160054
9516B XXL	095160055
9516B XXXL	095160056
9525TL	095250010 9525TR 095250011
9525F	095250099 9525CM 095250098
9525B	095251031 9525WB 095251032
9527MUG	095270020 9599CB-WN 095990024
9557N	095570001
9565BBQ	095650100
9565ICE	095650400
9595 C25	095950031
9599CB-W	095990023
9599 GARAGE-S	095990011
9599 GARAGE-M	095990012
9599 GARAGE-L	095990013
9599 GARAGE-XL	095990014
9599 GARAGE-XXL	095990015
C99T	099000492
C99M	099000494
C99T-V3	099000497
C99P-V3	099000498
11204C 40	112040204
11204C 60	112040206
11210C 40	112100204
11210C 60	112100206
11216C 40	112160204
11216C 60	112160206
11220C 40	112200204
11220C 60	112200206
11234B 40	112340104
11234B 60	112340106
11435 M-80	114350008
11435 M-120	114350012
11435 F-150	114350015
11435 F-180	114350018



Abbigliamento da lavoro	650÷670
Accessori Inox per funi	700÷706
Accessori per funi Robur	671÷714
Accessori portautensili per armadietti, cassetti e pareti	559÷561
Aerografi	347
Argani manuali e accessori	694, 699
Armadi per officina	433÷435; 452; 473÷474
Armadietti portautensili	402
Arredamento Officina	410÷478
Artigli prensili flessibili	219
Ascia antiscintilla	312
Aspiratore per liquidi	256
Aspiratori per solidi e liquidi	325÷326
Assortimenti di utensili	479÷532
Assortimenti utensili in moduli	533÷558
Attrezzi per il ripristino delle filettature	46÷47
Autoriparazione	118÷125, 160÷166, 170÷208, 229÷238
Avvolgicavo automatici con portalampada	314÷318
Avvolgitubo automatici per aria/acqua	347
Banchi da lavoro	401, 403÷409, 415÷420, 462÷464
Barre dinamometriche	62, 66÷68
Bauli portautensili	361, 363
Beta Abrasives	568÷584
Beta BM	588÷594
Beta Chemicals	562÷567
Beta Collection	715÷726
Bloccante	564
Bordatubi	32
Borse portautensili	354÷361
Bulini	9
Cacciaspina	9, 278, 304
Calibratore per tubi multistrato	31
Calibri a corsoio	210÷211
Carrelli portautensili	380÷382, 397÷400, 448, 469
Carrello contenitore elettrico	398
Carrello pieghevole	367, 398
Carrello porta cassettiere	369
Cartelli di avvertenza e divieto	668
Cassettiere mobili	371÷380, 386÷394, 421÷422, 443÷444, 462÷465
Cassettiere per industria	384÷385
Cassettiere portatili	368÷370, 392
Catene e colonnine in plastica di delimitazione	668
Cesoie	135÷136
Cesoie a cricchetto per tubi PVC	30
Cestelli portautensili	360÷363
Chiavi a bussola con impugnatura	113÷114, 288
Chiavi a bussola Macchina, accessori e assortimenti	70÷78
Chiavi a bussola snodate doppie	15
Chiavi a bussola, accessori e assortimenti 1"	110÷111
Chiavi a bussola, accessori e assortimenti 1/2"	99÷109, 288, 308
Chiavi a bussola, accessori e assortimenti 1/4"	86÷93
Chiavi a bussola, accessori e assortimenti 3/4"	109÷110, 308÷309
Chiavi a bussola, accessori e assortimenti 3/8"	93÷99, 287÷288, 307
Chiavi a cricchetto	25÷27, 294
Chiavi a forchetta	13÷15, 282, 286, 293, 305
Chiavi a percussione	14÷15, 305÷306
Chiavi a pipa	112÷113, 294, 309
Chiavi a settore	23÷24, 307



Chiavi a T con bussola esagonale e Torx®	114, 116÷117
Chiavi a T maschio esagonale e Torx®	115÷117, 287, 309
Chiavi a tubo	112÷113, 118
Chiavi a zampa di gallo	96
Chiavi combinate	11÷13, 25÷26, 294, 300, 305
Chiavi di manovra antiscintilla per valvole	309
Chiavi e barre dinamometriche	57÷69
Chiavi maschio esagonale e Torx® con impugnatura	21÷23, 293, 301
Chiavi maschio esagonale e Torx®, piegate	18÷23
Chiavi maschio piegate a profilo XZN®	23
Chiavi per ponteggi	17, 306
Chiavi per quadristi	210
Chiavi per raccordi	17
Chiavi poligonali	15÷17, 286, 293, 305÷306
Chiavi regolabili a rullino	24, 286, 293, 301, 307
Colla istantanea	565
Coltelli	239÷240, 312
Combo valigette e accessori	364÷367
Comparatori	212
Compassi	214
Compressori a leva per grasso	227
Contafiletti	218
Contalitri per olio	256
Curvatubi	34÷35
Cuscino sollevatore	241
Cutter	238÷239
Deghiacciante	567
Detergenti	566÷567
Dischi abrasivi	570÷572, 583
Dischi lamellari	576÷580
Dischi magnetici solleva lamiera per saldatura	253
Elettrotensili	313÷324
Estrattori a due griffe	198÷204, 208
Estrattori a tre griffe	200÷202, 208
Estrattori coni Morse	44
Estrattori idraulici	208
Estrattori per mozzi ruote	202÷203
Estrattori per viti e prigionieri danneggiati	171÷172
Estrattori vari	198÷204
Faretti	244
Fasce e funi per sollevamento	706÷709
Fascette	590÷593
Fascette in velcro	593
Filiere e assortimenti	47÷51
Flessibili magnetici	219
Flessometri e metri	215÷216
Forbici	136÷137, 241, 295, 312
Forbici per elettricisti	136÷137, 289, 295
Frenafili	563
Frese coniche	41
Fustelle	135÷136
Gamma blister	595÷609
Giramaschi e girafiliera	46, 49
Giratubi	33÷34, 294, 301, 307
Giravite a battere	149
Giravite a percussione	158÷159
Giravite a squadra	149
Giravite BetaEVOX	145÷148



Giravite BetaGrip	152÷156
Giravite BetamaX	157÷159
Giravite bivalenti	155÷156
Giravite cercafase	150
Giravite dinamometrici	60
Giravite elettrico EVOX-E	148
Giravite prensili	149
Golfari	682÷685
Goniometri per serraggi angolari	61
Goniometri semplici	213
Grasso spray	565÷566
Grilli per sollevamento	680÷682
Guaine isolanti	594
Guanti isolanti	291
Guarnizione liquida	564
Idraulica, vari	27÷35
Impermeabilizzante	567
Ingrassatore a leva	228
Inserti da 4mm	150
Inserti per avvitatori e portainseriti	78÷85, 155, 287
Lampade	242÷247
Leve	123, 218, 309
Lime	161, 220÷224, 312
Livelle e stadie	216÷217
Magnetizzatore-smagnetizzatore	144
Martelli	162, 166÷169, 296÷297, 302, 310÷311
Martinetto idraulico	208
Maschera per saldatura	254
Maschi e assortimenti	44÷47
Matita per falegnami	215
Mazze	169, 311
Mazzette	169, 311
Mazzuole	169÷170, 297, 311
Microgiravite	150÷151
Micrometri	211
Misuratori ambientali	236
Misuratori di coppia elettronici Dynatester	69
Misuratori laser	215÷216
Moduli portautensili	533÷558
Mole abrasive con gambo	573÷576
Moltiplicatori di coppia	54÷56
Morse magnetiche per saldatura	253
Morse parallele da banco	209
Morse ribaltabili da banco, per idraulica	35
Morsetti	209
Morsetti di coda	590
Morsetti per funi	678÷679
Multimetri	232÷233, 297
Nastro isolante	594
Occhiali di protezione	669
Oliatori	228÷229
Pala antiscintilla	312
Paranchi manuali e accessori	692÷693
Pareti portautensili	405, 430, 451, 470
Pedana rialzata	238
Pendenti di catena per sollevamento	685÷689
Pennello	225
Piccone antiscintilla	312



Pinza foralamiera	132
Pinza fustellatrice	236
Pinza piegalamiera	132
Pinze a becchi lunghi e lunghissimi	127÷128, 140÷143, 289÷290, 296, 310
Pinze amperometriche	234
Pinze autobloccanti	130÷132, 193, 295
Pinze per anelli elastici di sicurezza	128÷129, 173, 294÷295, 309
Pinze per capicorda e capicorda	585÷587
Pinze per elettronica	142÷143
Pinze per fascette	594
Pinze per saldatura	253
Pinze per sollevamento lamiere	692
Pinze regolabili	129÷132, 289, 295, 310
Pinze torcifilo	236
Pinze universali	139÷140, 289, 296, 310
Pinzette a molla	126÷127, 289
Pistola per olio	256
Pistole per colla	325
Pistole per sigillanti	227
Pistole termiche	325
Polifusori e matrici	27÷28
Pompa oleodinamica	163
Pompe per barili	256
Pompette per dissaldare	252
Porta attrezzi con cintura	354÷355
Portacarta	377÷378
Portaflaconi	377÷378, 477
Portaminuterie magnetici	238, 264
Postazione di lavoro mobile	383
Prodotti elettrici	585÷594
Protezioni per cassettiere	393
Provatensione	193
Pulitore spray	566÷567
Punte elicoidali cilindriche per forare	36÷40
Punte per forare, filettare e svasare	47
Punte per tracciare	215
Punte speciali per saldature	41
Punteruoli	220
Punzoni	9, 304
Radance	680, 702
Raggimetri	218
Rapportatore d'angoli	213
Raschietti	173, 184, 220, 239
Righe graduate	214, 297
Rinvio angolare	85
Ripara plastiche	166
Rivettatrici e rivetti	225÷227
Rotoli antispreco	584
Ruote lamellari e in tessuto	581÷583
Saldatori	250÷252
Saldatrici	252÷253
Sbavatori per tubi	31
Sbloccante spray	565
Scalpelli	10, 125, 218, 292, 300, 304, 312
Scalpelli per carrozzieri	161
Scalpelli per edilizia	217
Scarpe antinfortunistiche	624÷649
Segaccio per legno	224



Seggiolini con rotelle	262÷264
Seghe e frese a tazza e accessori	51÷53
Seghetti e lame	224
Serraggiunti e strettoie	209
Sigillaraccordi	563
Silicone sigillante	565
Silicone spray	566
Siringa per olio	229
Sistemi di ancoraggio	706, 710÷713
Sollevatori per bici	281÷282
Soluzioni per il punto vendita	610÷623; 669÷670
Sonda tirafili	587
Spaccadadi	219
Spatole	224, 312
Spazzole	224÷225, 312
Specchietti	219
Spellacavi e spellafili	138÷139
Spessimetri	219
Squadre	212÷213
Squadre magnetiche per saldatori	253
Supporto per avvitatore pneumatico	333
Tachimetro digitale	235
Tagliacavi	138, 289
Tagliafuni di acciaio	135
Tagliatubi	28÷32, 307
Tappeto da lavoro	263, 276, 291, 409, 726
Tappeto isolante	291
Tappeto protezione ginocchia	263
Tenaglie	134
Tenditore per molle	224
Tenditori per funi e accessori	672÷677
Terminali preisolati	589
Termocamera	236
Termometri	235
Termopiastre per tubi plastici	28
Torçe	242÷243
Traccialinea e polvere	218
Trolley portautensili	355÷356, 359÷361, 395÷396
Troncabulloni	134, 310
Tronchesi a taglienti diagonali e frontali	133÷134, 289, 295, 301
Tronchesi per elettronica	143÷144
Ugnetti	10
Utensili a batteria	313÷321
Utensili a filo	322÷325
Utensili anticaduta	292÷298
Utensili antiscintilla	304÷312
Utensili in acciaio inossidabile	299÷303
Utensili isolati 1000V	285÷291
Utensili per biciclette	280÷284
Utensili per motocicli	274÷279
Utensili pneumatici ed accessori	327÷350
Valigie portautensili	351÷357, 364÷366
Vasca di lavaggio ad ultrasuoni	260÷261
Ventose	237
Videoscopio elettronico	122
Zaini portautensili	358
Zinco spray	567

Automotive



Alesatori per sedi iniettori	121
Asta telescopica	238
Attrezzi per centraggio frizioni	172
Attrezzi per estrazione autoradio	237
Attrezzi per pistoni	173
Attrezzi per pulegge distribuzione	175
Attrezzi per rimozione cristalli	237
Attrezzi per tubi scarico	182
Attrezzi verifica bolli carrozzeria ø 80	163
Attrezzo levabolli	162÷164
Attrezzo per pistoncini freni a disco	178
Attrezzo per smagliatura catene	278
Avviatori	194÷195
Barre di torsione per dadi ruote	77
Calibri a corsoio per dischi e tamburi freni	210
Calibro per battistrada pneumatici	218
Caricabatteria	195÷197
Carrello per cambi/trasmissioni	400
Carrello per movimentazione veicoli	266
Carrello sottoscocca	265
Cavalletti	266
Cavalletti per moto	274÷275
Chiave per braccetti sterzo	207
Chiave per turbine	182
Chiavi a bussola Macchina per dadi ruote	72÷73
Chiavi a bussola Macchina quadre per dadi ruote Isuzu	76
Chiavi a bussola per dadi mozzi ruote	123
Chiavi a bussola per iniettori Diesel	119
Chiavi a bussola per perni balestre	206
Chiavi a bussola per sonda Lambda	119
Chiavi a croce per dadi ruote	124
Chiavi e bussole per candele d'accensione	118÷119
Chiavi per filtri gasolio	190
Chiavi per filtri olio motore	187÷191
Chiavi per ghiera galleggiante serbatoio	185
Chiavi per raccordi carburante	174
Chiavi per sensori di temperatura	120÷121
Chiavi per tappi scarico olio motore	191÷192
Densimetro per liquido anticongelante	231
Densimetro per liquido batteria	231
Estrattore per raschiavetri	237

INDICE ALFABETICO UTENSILI PER AUTORIPARAZIONE



Estrattori per giunti omocinetici	207
Estrattori per pioli	182
Estrattori per snodi sferici	207
Fustelle per sensori parcheggio	165÷166
Gru idraulica pieghevole	267
Imbuto	229÷230, 312
Inseritori a percussione per cuscinetti conici e paraoli	208
Lamina modellabile in alluminio	230
Lavaggio auto interni/esterni	255, 262, 346, 609
Lettini sottomacchina	263÷265
Leva per cambio DSG	172
Leva per estrazione testine braccio oscillante	207
Levagomme	122÷123, 283
Leve per carrozzieri	161
Lime per carrozzieri	161
Martelli per carrozzieri	162
Morsetti alzavalvola	173
Perni guida montaggio ruote	124÷125
Pinza per anelli di tenuta valvole	174
Pinza per anelli elastici di sicurezza SP	173
Pinza per copertura plastiche delle ruote	124
Pinza per equilibratura ruote	125
Pinza per graffette	236
Pinze per anelli stringitubo	179÷180
Pinze per cappucci candele	181
Pinze per freni	178
Pinze per occlusione tubi e manicotti	184
Pinze per raccordi rapidi tubi carburante	185
Pinze per relè	192÷193
Pistola per gonfiaggio pneumatici	345÷346
Pompa per taratura e controllo iniettori Diesel	122
Postazione mobile per strumenti diagnosi	397
Presse idrauliche	269÷270
Pressori per molle ammortizzatori	205
Protezioni per auto	263
Protezioni per ruote	124
Provatensione	193
Rabboccatore per batterie	229
Recuperatori olio esausto	255÷256
Rilevatore di segnale	234
Sabbiatrice da banco	261
Smerigliavalvole pneumatico	173
Sollevatore ruote truck	266
Sollevatori idraulici a bottiglia	266
Sollevatori idraulici a ruote	271÷272

INDICE ALFABETICO UTENSILI PER AUTORIPARAZIONE



Sollevatori idraulici da fossa	267÷268
Sollevatori oleopneumatici	273
Sostegni motore	267
Spatoline in acciaio Inox	161
Spazzola per morsetti batteria	225
Spessimetri per carrozzieri	162
Spotter carrellato per carrozzeria	164
Stabilizzatore di tensione	198
Stazione di ricarica climatizzatori	259÷260
Stazione per cambio automatico	257÷259
Stazioni lavaggio componenti motore	262
Stetoscopio	198
Strumenti estrazione liquido freni	177
Strumenti per controllo impianto raffreddamento	231
Strumento per controllo compressione motori a benzina e Diesel	122
Tallonatori per gomme	346
Tassi per carrozzieri	160÷161
Tenditori per molle	171
Tester digitale pressione e compressione	175
Tester per batteria e impianti di ricarica	197÷198
Tirabolli pneumatico	164
Transpallet manuale	273
Utensile per rimozione guarnizioni	203
Utensili per airbag	172
Utensili per bobine candele	181
Utensili per connessioni elettriche	193
Utensili per estrazione silent block	208
Utensili per impianti di condizionamento	186
Utensili per iniettori Diesel Common Rail	121
Utensili per riempimento filtri gasolio	184
Utensili per rimozione candele preriscaldamento	121
Utensili per valvole pneumatici	124÷125
Vasca per pulizia pezzi	261÷262
Vasche per recupero liquidi	255÷256

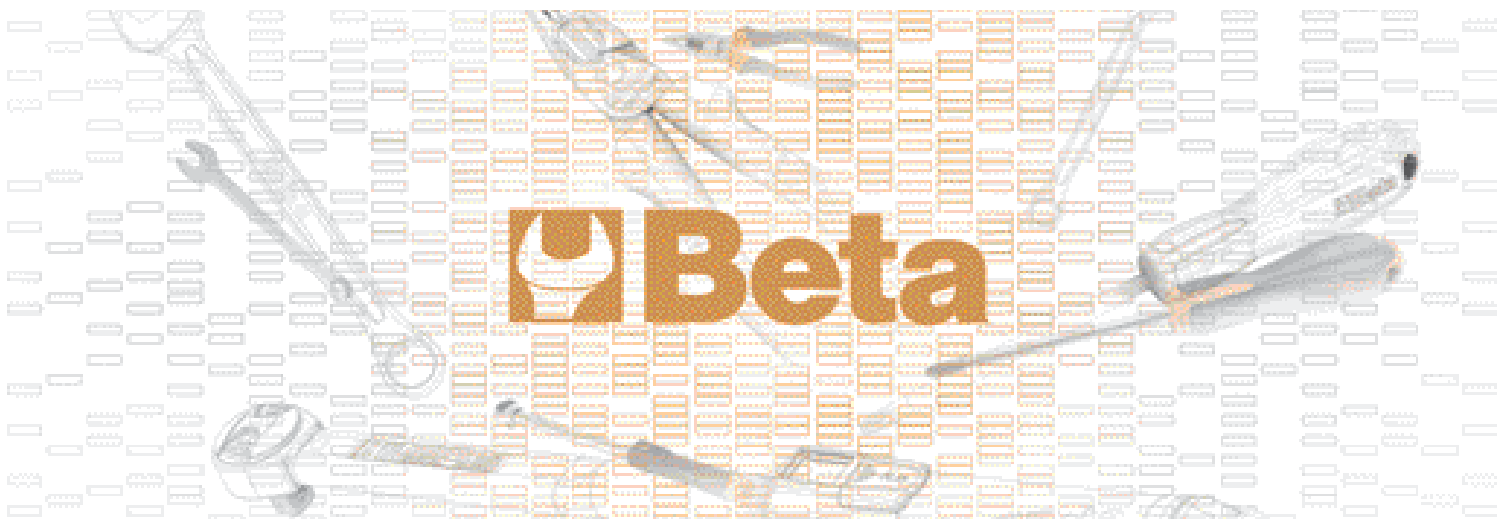

1								
100	24	1032	128	1082GBM	133	1128BMX	601 1164	141
100/KIT	24	1032BA	309	1082GBMK	600	1128BSX	137 1164BM	141
110BA	307	1032K	600	1082GK	600	1128BSX	601 1164BMK	602
110MQ	286	1033	128	1082K	600	1128FX	137 1164K	602
111CM	24	1033K	600	1082MQ	289	1128FXS	137 1164MQ	289
111E	24	1034	128	1084	133	1128MQ	289 1166	141
111EN	24	1034K	600	1084BM	133	1129BM	137 1166BA	310
111ER	24	1034L	129	1084BMK	601	1129BMK	601 1166BM	141
120	25	1036	129	1084G	133	1130BMX	137 1166BMK	603
120/B6N	25	1036BA	309	1084GBM	133	1130BMX	602 1166G	141
123/K4	25	1036K	600	1084GBMK	601	1131CK	137 1166GBM	141
123/K4	597	1037	129	1084GK	601	1132	138 1166GBMK	603
123E1/4	25	1037K	600	1084K	600	1132BM	138 1166GK	603
123Q1/2	25	1038	129	1084MQ	289	1132BMK	602 1166K	602
123Q1/4	25	1038K	600	1088	133	1132K	602 1166MQ	289
123Q3/8	25	1039	129	1088BM	133	1132MQ	289 1168	141
141	25	1044N	129	1088BMK	601	1133	138 1168BM	142
141/B	25	1044NK	600	1088K	601	1133RL	138 1168BMK	603
141/S	25	1046BA	310	1088MQ	289	1134	138 1168G	141
142	25	1047	129	1092V	134	1134A	138 1168GBM	142
142/B	26	1047BM	129	1094V	134	1134RL	138 1168GBMK	603
142/S	26	1048BM	130	1095N	134	1137BA	310 1168GK	603
142/SC9I-E	26	1048MQ	289	1096	134	1137BA/RC	310 1168K	603
142AS	26	1048N	130	1096K	601	1142BM	138 1168MQ	290
142AS/S	26	1048N/D3	130	1098	134	1142BMK	602 1169/D3	142
142C	26	1048NK	600	1098K	601	1142MQ	289 1169BM/D3	142
142C/A	26	1048VN	130	1098PL	134	1143	138 1169G/D3	142
142K	597	1048VNK	600	1098PLK	601	1143R	138 1169GBM/D3	142
142MC	26	1050	130	1100BA 600	310	1144D	138 1169MQ/D2	290
142MC/SC9I-E	26	1051	130	1101	134	1144D/RG	138 1169N/D4	142
142SN	26	1051GM	130	1101R	134	1144D/RL	138 1171BM	142
142SN/S	26	1051L	130	1102	134	1144G	138 1172BM	142
142SN/SC9	26	1051XL	130	1103	134	1144G/RL	139 1172BM/P	143
186	27	1052	130	1103R	134	1144L	139 1173BM	143
187	27	1052BA	310	1104	135	1144T	139 1175BM	143
187/B5	27	1052K	600	1104R	135	1148A	139 1177BM	143
188	27	1053	131	1105	135	1148A/R	139 1177BM/Z	143
192	27	1054	131	1105/C10T	135	1148B	139 1178BM	143
192/S2	27	1055	131	1105/C16T	135	1148B/R	139 1178BM/P	143
192/S2	597	1055D	131	1105/C32T	135	1148P	139 1182BM	143
194	27	1056	131	1105AD-50	135	1149F	139 1182BM_nota	143
195	27	1057A	131	1105T20	135	1149F	602 1183BM	144
195/B5	27	1058	131	1105T30	135	1150	139 1184BM	144
195AS	27	1059	131	1105T50	135	1150BA	310 1185BM	144
195AS/B	27	1060	131	1112	135	1150BM	140 1186BM	144
195K	597	1061	131	1112K	601	1150BMK	602 1188BM	144
195P	27	1062	131	1114	136	1150G	139 1190BM	144
195P/B5	27	1062AL	132	1118	136	1150GBM	140 1191BM	144
1002	127	1062GM	132	1120A	136	1150GBMK	602 1191BM/L	144
1008	127	1063	132	1120ARL - ARG	136	1150GK	602 1191R/5-M	144
1008BM	127	1064	132	1122	136	1150HPC	140 1200MS	144
1009	127	1064F	132	1122 - 1125MOL	136	1150K	602 1201E	145
1009L/A	127	1065P	132	1122K	601	1150MQ	289 1201E/DZ	146
1009L/B	127	1066	132	1123	136	1153	140 1201E/K	603
1009L/C	127	1067	132	1123K	601	1162	140 1201E/S6	145
1009L/D	128	1077	132	1124	136	1162BA	310 1201EN	145
1009L/DP	128	1078	132	1124K	601	1162BM	141 1201EN/K	603
1009L/DP-S2	128	1080D	132	1125	136	1162BMK	602 1202E	146
1010	128	1081	133	1126	136	1162G	141 1202E/K	603
1010BM	128	1082	133	1127	136	1162GBM	141 1202E/S4	146
1010MQ	289	1082BA	310	1128BAX	136	1162GBMK	602 1202EL	146
1031/S4	128	1082BM	133	1128BM	137	1162GK	602 1202EN	146
		1082BMK	600	1128BMX	136	1162K	602 1202EN/K	603
		1082G	133	1128BMX/F	136	1162MQ	289 1203/E10P	612

INDICE ALFANUMERICO

1203/E1P	612	1260EK	604	1279MQ/S	291	1308	160	1366SL	164
1203/E4P	612	1260K	604	1281/B28A	156	1310	160	1366ST	164
1203/E5P	612	1260MC	153	1281BG	155	1312	160	1367/K10	166
1203E/D	146	1260N	152	1281BG/A9	156	1314	161	1367/K4	166
1203E/S	146	1260NK	604	1281BG/B28NA	156	1326	161	1367/S4	165
1204E	146	1262	153	1281BG-TX/A8	156	1327	161	1368	166
1204E/K	603	1262/S4	153	1281LP	155	1328	161	1368G/C2U	166
1204E/S5	146	1262E	153	1281LPH	156	1329	161	1368G/CV	166
1204EL	147	1262EK	604	1281PB	155	1330	161	1368G/K400	166
1205E/ES	147	1262K	604	1281PE	156	1331	161	1368G/OD	166
1205E/ES-S8	147	1262L	153	1281PH	156	1335BM	161	1368G/SD	166
1206E/BP	147	1262MC	153	1281PM	155	1337/S5	161	1369/C11	167
1206E/BP-S7	147	1262N	153	1281PZ	156	1338	161	1370	167
1207E TX/K	603	1262NK	604	1281RTX	156	1338A - 1338B	161	1370/MR...	167
1207E/TX	147	1263/D...	153	1281TX	156	1338R9 - 1338R12	161	1370BA	310
1207E/TX-D	147	1263/E39	613	1290	157	1342	161	1370BA/MR	311
1208E RTX/K	603	1263/E40	613	1290/S	157	1342PM	161	1370BA/PL	311
1208E/RTX	147	1263/E50	613	1290K	605	1342PMR	161	1370F	167
1208E/RTX-D	147	1263/E62	613	1290K/INOX	605	1343	161	1370F/MR...	167
1209E PZ/K	603	1263/E70	613	1290N	157	1344	162	1370FT	167
1209E/PZ	147	1263/E74	612	1290NK	605	1344A/VW	162	1370T	167
1209E/PZ-S4	147	1263/E78	612	1292	157	1345	162	1374F	167
1209EN/PZ	147	1263/E85	613	1292/S4	157	1351	162	1374F/MR...	167
1209EN-PZ/K	604	1263/S12	154	1292K	605	1353	162	1375	168
1210E/GE	148	1263MC/D8	154	1292K/INOX	605	1357Z/45	162	1375/MR	168
1211E/GE	148	1264	154	1292L	157	1359T	162	1375A	168
1229LP/S	148	1264/S5	154	1292N	157	1360/K6	162	1375B	168
1229LPH/A6	148	1264K	604	1292NK	605	1360/KP3	162	1375BA/PL	311
1236B	149	1264L	154	1293/D...	158	1360G	162	1376X	168
1238B	149	1265ES	154	1293/S...	158	1361/C12	162	1376X/MR	168
1241	149	1265ES/S8	154	1293BP	158	1361/K9	162	1376XT	168
1242	149	1266BP	154	1293BP/S	158	1362B	163	1376XT/MR	168
1243/D7	149	1266BP/S8	154	1293BX/DA	614	1364SCP	163	1377	168
1243/S11	149	1267MC/TX	155	1293BX/DD	614	1364SE	163	1377/MR...	168
1243LP/D6	149	1267MC/TX-D7	155	1293BX/DE	614	1364SP	163	1377BA	311
1250	149	1267TX	154	1293BX/DF	614	1364SR	163	1377BA/PL	311
1251	149	1267TX/D7	155	1293ES	158	1364SV	163	1377T	168
1252/S5	149	1267TX/S13	155	1293ES/S7	158	1365/K13	163	1378	168
1253	150	1267TXK	604	1294	158	1365P10	163	1378/MR...	168
1253	604	1268RTX	155	1294/S7	158	1366/K5	164	1379BA	311
1253A	150	1268RTX/S8	155	1294K	605	1366A	163	1379F	168
1254	150	1268RTXK	604	1294L	158	1366B	164	1379F/MR...	169
1254	604	1269N/PZ	155	1295	158	1366KF	164	1380	169
1256/20	150	1269N/PZK	604	1295/C14	159	1366S/R1	164	1380/MR...	169
1256/30	150	1269PZ	155	1297TX	159	1366S/R10	165	1380BA	311
1256/C36-2	150	1269PZ/S4	155	1297TX/D6	159	1366S/R11	165	1380BA/MR	311
1256LP	150	1269PZK	604	1297TX/L	159	1366S/R12	165	1380BA/PL	311
1256PE	150	1270BA	310	1297TX/L-S5	159	1366S/R13	165	1380S	169
1256PH	150	1272BA	310	1297TX/S12	159	1366S/R14	165	1380S/MR...	169
1256PZ	150	1272MQ	290	1298RTX	159	1366S/R2	164	1380T	169
1256RTX	150	1272MQ/S	290	1298RTX/S8	159	1366S/R21	165	1381	169
1256TX	150	1272MQF	290	1298RTXK	605	1366S/R22	165	1381/MR...	169
1257BE	151	1273MQ/D6	290	1299N/PZ	159	1366S/R24	165	1381BA	311
1257ES	151	1273MQ/E1	614	1299N/PZK	605	1366S/R25	165	1381BA/MR	311
1257ESB/S8	151	1273MQ/E4	614	1299PZ	159	1366S/R26	165	1381BA/PL	311
1257LP	150	1273MQF/D6	290	1299PZ/S6	159	1366S/R3	164	1381T	169
1257LP/S	151	1274MQ	290	1299PZK	605	1366S/R4	165	1385	169
1257LPH/S8	151	1274MQ/S	290	1302	160	1366S/R5	165	1385/MR	169
1257PH	151	1274MQF	290	1303	160	1366S/R6	165	1390	169
1257TX	151	1275MQ/C	290	1304	160	1366S/R7	165	1390/MR...	169
1257TX/S	151	1276MQ/C	291	1305	160	1366S/R8	165	1390BA	311
1260	152	1277BA	310	1305Z	160	1366S/R9	165	1390BA/R	311
1260/S6	152	1279MQ	291	1306	160	1366SH	164	1390N	170
1260E	153	1279MQ/F	291	1307	160	1366SH/C	164	1390NR	170

INDICE ALFANUMERICO

1390R	170	1464PB	176	1474L	181	1485R/P10	187	1495M	192
1391	170	1464PF	177	1475U	181	1485R/P17	187	1495T	192
1391A	170	1464PT	176	1476	182	1485TC	186	1496/C	192
1392	170	1464T	175	1476/RC	182	1485VAG	187	1497/C23	193
1392R	170	1464T/SP80	175	1476A	182	1485VAG/K2	187	1497/C94	193
1393	170	1464TDI	176	1476A/RC	182	1485VLV/T	186	1497/S3	193
1410/M	171	1464VD	176	1476C/1	182	1487/K2	187	1497BS	193
1428	171	1465	177	1476GT	182	1488 - 1488L	187	1497D	192
1428/SB11	171	1466/C5	177	1476PSA	182	1488/1	187	1497KB/S3	193
1428L	171	1466L 11	177	1476T	182	1488R...	187	1497P	193
1428L/B3	171	1466TLF	177	1477/C10	182	1489/31T	187	1497RC	193
1429	171	1467	177	1477D	182	1489/33	187	1497SS	193
1429/SB7	171	1467/RK1	177	1477D/S5	182	1489/33P	188	1497TE	193
1430/...	171	1467/RK2	177	1477K/7	182	1489/C14	188	1498	193
1430/S	171	1467LF/2	177	1478	182	1489/E	188	1498/12	195
1431/...	171	1467LF/RC	177	1478/K3	183	1489/Y	188	1498/120A	197
1431/C5	171	1467T/C6	178	1478NSS	183	1489R	188	1498/12-24 R20	195
1433	171	1467TU	178	1478SP	183	1490	188	1498/16A	196
1433/C11	172	1470	178	1478T	183	1490/R1 - 1490/R2	188	1498/24	195
1435	172	1470FT	178	1479	183	1490F	188	1498/25A	196
1435/1	172	1470PF	178	1479/B27	183	1491	188	1498/2A	195
1435/1R	172	1471	178	1479L/K4	183	1491A	188	1498/2A-8A-PR	196
1435R	172	1471A	178	1479L/S2	183	1491R	188	1498/40A	197
1437/C12	172	1471CF	179	1479LB/C5	183	1491T	188	1498/4A	195
1438	172	1471CM	179	1479LV/S3	183	1492/1 - 1492/2	189	1498/4A-8A CO	196
1438DCT/S	173	1471CM/E11	179	1479ML/B17	183	1492T	189	1498/4A-8A CP	196
1438DSG	172	1471D2	179	1479ML/S3	183	1493	189	1498/8A	196
1438EVO	172	1471GF	178	1479N/S5	184	1493/C19	190	1498B12/R02	195
1438K/DSG-2	172	1471M/50	178	1479RB/1	184	1493/C30	189	1498BC/12	194
1438K/PWR	172	1471M/C22	178	1479RB/2	184	1493/C7	190	1498LT/12	194
1438R	172	1471MP	178	1479RB/3	184	1493/PF	189	1498LT/12-24	195
1439/K7	173	1471M/W50	179	1479U/13	184	1493/S-U	191	1498LT/12-R7	194
1440/...	173	1471PN/B1	179	1479U/32	184	1493AL	189	1498LT/12-SF	194
1445/1 - 1445/2	173	1471PN/B2	179	1480	184	1493AL 4S	189	1498MN/12-C	194
1452K	173	1471PN/B3	179	1481/C12	184	1493AL CF	190	1498MN/12-P	194
1452PN/K	173	1471PN/B4	179	1481K/S4	184	1493B	189	1498MN/12-R	194
1454P	173	1471PN/B5	179	1481PL	184	1493B/S5	189	1498MN/12-U	194
1455SVP	173	1471PT/C5	179	1481PL/S3	184	1493C/ADB	191	1498PC	198
1455SVP/R...	173	1471T/C5	179	1481T/C12	185	1493DSG	190	1498SA/2A-4A	195
1457/B4	173	1472	179	1482	185	1493FF	190	1498SM	197
1458	173	1472AU	179	1482/8 - 1482/10	185	1493FT	190	1498SM-A	197
1460F	174	1472AU/P	180	1482A/1	185	1493H	190	1498SM-C	197
1462/EI	174	1472AU/RP	180	1482A/3	185	1493HK	190	1498SM-CP	197
1462/KI	174	1472B/RNLT	180	1482A/5	185	1493J	190	1498ST/TB	198
1462/KU	174	1472FC	180	1482B	185	1493U/ADB	191	1498ST/TB ROT	198
1462/MB	174	1472FC/GE	180	1482C	185	1493VW	190	1498TB/12-24	198
1462AD/BSC	174	1472FC/L	180	1482D	185	1493X	191	1498TB/6-12	197
1462AD/SMN	174	1472FCA	180	1482SN	185	1493Y	191	1499	198
1462CF	174	1472FCL/RP	180	1483K/12	185	1494	191	1500/...	198
1462CF/C6	174	1472H	180	1483K/22	186	1494/C14A	192	1500/SP	198
1462CF-SN	174	1472MT/VW	180	1483KV-PT/S7	81	1494BMW	191	1500G/...	198
1462CF-SN/C6	174	1472R/AU	180	1484	186	1494E	191	1500N/...	198
1463/KIT	175	1472TM	180	1484PSA	186	1494FPC	191	1500N/G...	199
1464ADB	176	1472VW	180	1485/KIT	186	1494M	192	1500N/SP	199
1464AP	175	1473	181	1485BP	186	1494MAN	191	1501/1 - 2 - 3	199
1464AP T	175	1473A	181	1485BPM	186	1494MRC	191	1501G/1 - 2 - 3	199
1464AP T16X12	175	1473FN	181	1485FCA/K2	186	1494Q	192	1501Z/S - P - R	199
1464APB	176	1473P	181	1485FCA/T	186	1494T	192	1502/...	199
1464CBD	175	1473T	181	1485FCA/TS	186	1494T/C5	191	1505/C5	200
1464FAP	176	1474/C4	181	1485FRD/T	186	1494VW	191	1505V	199
1464FG	176	1474DL	181	1485MJ	187	1494VW/K	192	1506	200
1464FG/CP4	176	1474E/VW	181	1485MRC/T	186	1494VW/KT	192	1508/1 - 1508/2	200
1464IC	175	1474E/VW2	181	1485PMTJ	187	1494XZN	192	1511/1 - 2 - 3	200
1464IC/RK	175	1474G	181	1485R	187	1495/C6	192	1515/1 - 2 - 3	200

INDICE ALFANUMERICO

1516/1 - 2 - 3	200	1566R	207	1679	213	1709/10 - 1709/18	219	1719BMR/B3	223
1517	200	1567	207	1679/PR	213	1710	219	1719BMX...M	222
1517C/...	201	1568	208	1680	214	1712E/1 - 2 - 3	219	1719BMX...P	222
1518/...	201	1569/F	208	1680A	214	1712TF	219	1719BMX...Q	221
1518U/...	201	1569/SB	208	1680B	214	1713M	219	1719BMX...R	222
1519/...	201	1569CP	208	1680C	214	1713M/K7	219	1719BMX...S5	222
1520/1 - 1520/2	202	1570/3	208	1682	214	1714	219	1719BMX...T	221
1521/1 - 1521/2	202	1580/8I	208	1683	214	1715	219	1719R/...	223
1528	202	1580GL	208	1685/C7	214	1715B/R5L	219	1720/...	223
1529	202	1585/5I - 6I - 7I	208	1687/S4	214	1715F/L/A	219	1720/B	223
1529/C7	202	1585GI/5 - 6 - 7	208	1687A	214	1715F/L/B	219	1720/S	223
1529/PG	202	1589PI/50 - 100 - 150	208	1687AC	214	1715I	219	1720D/...	223
1529PI	202	1589VI	208	1687D	214	1715L	219	1720D/B	224
1530/C16	202	1590	209	1687U	214	1715R/FL	219	1721/B6	224
1530/C5	202	1591	209	1688	215	1716A	219	1723	224
1531/C7	203	1593	209	1688A	215	1716P	220	1725	224
1532	203	1594	209	1688M	215	1716R	220	1725CR	224
1533/...	203	1595	209	1688PC	215	1716U	220	1725MQ	291
1533PR/1 - 2 - 3	203	1599B	209	1688PC/R	215	1717A	220	1726	224
1534/...	203	1599F	209	1690F	215	1717B	220	1726BM	224
1535/C...	203	1599G	210	1690L	215	1717BA	312	1727	224
1539	203	1599GI	209	1691BM	215	1717BA/1	312	1727BA	312
1540	203	1599GR	209	1691MG	215	1717C	220	1727BM	224
1542/1 - 1542/2	204	1599P	209	1692	215	1717D	220	1728...	224
1544/...	204	1599T	209	1693	215	1717T	220	1728BA	312
1545/C5M	204	1600Q 10	210	1693	606	1717T RS	220	1729CG	224
1547/C6	204	1600Q 10	606	1693L	215	1717T RT	220	1729DM 450	224
1547KP	204	1600Q 8	210	1693M	216	1717V	220	1730	224
1547P	204	1600Q 8	606	1694/L	216	1717V R	220	1730M	224
1547PC/2	204	1602BA	312	1694A/L	216	1718A...M	221	1730V 38	224
1547PL/2	204	1603BK	606	1694B/L	216	1718A...P	221	1736A	224
1549	204	1603K	606	1695XS	216	1718A...Q	220	1737	225
1550U	205	1650	210	1696	216	1718A...R	221	1737AC	225
1550U/CGS-R	205	1650FD	210	1696A	216	1718A...S5	221	1737B	225
1550U/M	205	1650FT	210	1696B	216	1718A...T	221	1737BA	312
1550U/MRC-ABE	205	1651DGTB	210	1696D	217	1718D...M	221	1737NX	225
1550U/MRC-C	205	1651DGTB/IP	211	1696S	217	1718D...P	221	1738	225
1550U/S...	205	1652	211	1697	217	1718D...Q	220	1739C	225
1550U/SS187	205	1654	211	1699L	217	1718D...R	221	1740AN	225
1551/C20	205	1654DGT	211	1699L/1	217	1718D...S5	221	1740B	225
1552/C9	205	1656	211	1699Q	217	1718D...T	221	1741B	225
1555/Q	206	1657DGT/2	211	1700N	217	1719BA12	312	1741B/C5	225
1555/QS	206	1658/...	211	1700N/PM	217	1719BA8	312	1741BP	226
1555C	206	1658/C4	211	1701_WARN	218	1719BM/RG	223	1741RV...K	226
1555S/BMW-RNT	206	1658DGTB	211	1701BA	312	1719BM/RL	223	1741U	226
1556/1A	206	1658SP/1	212	1701N	217	1719BM/RP	223	1742AN	226
1556/2A	206	1659	212	1701N/PM	217	1719BM/RR	223	1742AN/C	227
1557	206	1662/1 - 1662/2	212	1701NE/...	218	1719BMA...B5	222	1742AN/KR	227
1557/S3	206	1662AN	212	1701PMR	218	1719BMA...M	222	1742N	226
1557V	206	1662DGT/A	212	1702N	218	1719BMA...P	222	1742N/C4	226
1558/C13	206	1662SP0	212	1702N/PM	218	1719BMA...Q	221	1742N/KR	226
1558/C4	129	1662SP2	212	1702PMR	218	1719BMA...R	222	1742R-A/M...	226
1558P	206	1666	212	1703BA/A	312	1719BMA...S5	222	1742R-AL/M...	226
1559	207	1666A	212	1703BA/P	312	1719BMA...T	221	1749	227
1559V/8T	207	1668	212	1703BA/PL	312	1719BMB/P	223	1749A	227
1560/2	207	1668A	213	1704	218	1719BMC	223	1749A/RB	227
1560A	207	1670	213	1704A	218	1719BMD...B5	222	1749A/RT	227
1561/...	207	1670A	213	1704C	218	1719BMD...M	222	1749AC	227
1562D	207	1672	213	1705	218	1719BMD...P	222	1750	227
1563/C4	207	1672A	213	1705PT	218	1719BMD...Q	221	1750CG	227
1565/1 - 2 - 3	207	1674A	213	1706DGT	218	1719BMD...R	222	1750KG10	228
1566/GO1	207	1674C	213	1707	218	1719BMD...S5	222	1750M	228
1566N	207	1676	213	1707A/1 - 2 - 3	218	1719BMD...T	221	1750M3	228
1566P	207	1678/C3	213	1708/8 - 13 - 20	219	1719BMR	223	1750R/1 - 1750R/2	227

INDICE ALFANUMERICO

1750RC	227	1760TMC	236	1778SCL	240	1838UV	246	1877P	255
1750RP/1 - 1750RP/2	227	1760WMM	236	1778SOS	240	1839/R1	246	1878 11	256
1750RT	227	1761	236	1778V18	240	1839/R2	246	1878 2	255
1750TA	228	1761RS/1	236	1778X	240	1839/R4	246	1878 3	255
1750TLA	228	1762	236	1781	241	1839/R5	246	1878 30	256
1751CR	228	1762K	607	1783	241	1839/R6	246	1878 4	255
1751N	228	1763	236	1783	607	1839BRW	246	1878 8	256
1752	228	1763G/S500	236	1784	241	1842	248	1879	256
1754	228	1764/K5	236	1784BA	312	1842LED/ABM	247	1879 6	256
1755C	229	1764/K5-R	236	1800/100	241	1842LED/BM	247	1879/FUEL	256
1756	229	1765/C24	237	1808	251	1843	248	1879R/K4	256
1756B	229	1766	237	1812 150	251	1844	248	1880	256
1756C	229	1766/8	237	1814M	251	1844SCK	248	1880ADB	256
1756C-2OR	229	1766A	237	1820	251	1845	248	1881	256
1756D	229	1766ER	237	1820 60	251	1846	248	1882N	256
1756D-2OR	229	1766ER/VW	237	1820 80	251	1846R-LED/BM	248	1883N	256
1756E	229	1766G	237	1822	251	1847	249	1883NC	257
1756G	229	1766I	237	1822 180	251	1848	249	1884	257
1757	229	1766L	237	1822 320	251	1850D	325	1884/C12	257
1757A	229	1766LI	237	1823 60	251	1850E	325	1884N/C8	257
1758	229	1766T	237	1823R/60	251	1851VK	325	1885	257
1758A	230	1767A	238	1824R	251	1851VK-12C	325	1885/C1	258
1758ADB-45°	230	1767B	238	1825B	251	1851VK-12V	325	1885/C1-R1	258
1758ADB-D	229	1767PMC	238	1827	251	1852 S-PIATTE	249	1885/C1-R2	258
1758B	230	1767PMR	238	1827/K	252	1852R1750	249	1885/C1-R3	258
1758B/K5	230	1768	238	1827F	252	1852S-CC	249	1885/C1-R4	258
1758B-1,6	230	1770	238	1827PC	251	1852S-CNT	249	1885/C1-R5	258
1758BA	312	1770A	238	1827PCL	251	1852S-F	249	1885/C1-R6	258
1758B-RNT	230	1770BM	238	1827PFL	252	1852S-FLESS	249	1885/C1-R7	258
1758LG	230	1770BM	607	1830T	252	1852S-KR/CNT	249	1885/C1-R8	258
1758M	230	1770RL	238	1833L	243	1852S-L	249	1885/C2	258
1758R	231	1771	238	1833L/USB	242	1860BH R/CM	252	1885/C2-R1	258
1758RD	230	1771BM	238	1833M	243	1860BH R/CS	252	1885/C2-R2	258
1758S	230	1771HD	238	1833MW	243	1860BH/120A	252	1885/C2-R3	258
1758VT	231	1771RL	238	1833RB-L/USB	242	1860BH/160A	252	1885/C2-R4	258
1758VT/L	231	1772H	239	1833S	243	1860BH/200A	252	1885/C2-R5	258
1759	231	1772M	238	1833XL	243	1860BHT R/CM	253	1885/C2-R6	258
1759A	231	1772R	239	1833XS/1	242	1860BHT R/CS	253	1885/C2-R7	259
1759B	231	1772R	607	1833XS/2	242	1860BHT/160A	253	1885/C3	259
1759HD/3	231	1772RL/2	239	1833XSW	243	1860BHT/T	253	1885/C3-R1	259
1759HD/RR	231	1773A	239	1834RR	608	1860DM	253	1885/C3-R10	259
1759HD/TRUCK	232	1773RL	239	1836AW	243	1860EI	253	1885/C3-R2	259
1759LR	232	1773S	239	1836B	243	1860M	253	1885/C3-R3	259
1759TT	232	1773S/RL	239	1837C	244	1860PMIG	253	1885/C3-R4	259
1760/IR1000	235	1774	239	1837F	243	1860RG	253	1885/C3-R5	259
1760/IR1600	235	1774A	239	1837F/USB	244	1860SQ	253	1885/C3-R6	259
1760/IR500	235	1774A/RL	239	1837M	244	1870	325	1885/C3-R7	259
1760/OHM	233	1774S	239	1837RB-F/USB	244	1870-20/5S	326	1885/C3-R8	259
1760/RMS	233	1776BA	312	1837S	244	1870-72 /FC	326	1885/C3-R9	259
1760/RSE	234	1777BM	239	1838/11LED	245	1870-72/FL	326	1885/XC60	259
1760/TC2	235	1777BMT	239	1838AM	245	1870I	325	1889CF	257
1760B	233	1777BMT	607	1838COB	245	1872L	326	1889N	257
1760DGT	232	1777MQ/C	291	1838E	246	1872L 35/5S	326	1893/1234YF	260
1760DGT/2	233	1777MQ/U	291	1838E-BT	246	1872L 35/FC	326	1893/134A	259
1760DGT-R3	234	1777RL/U	291	1838FLASH	244	1873	326	1893TR/1234YF	260
1760K	235	1777T	239	1838P	245	1873-30/5S	326	1893TR/134A	260
1760LX	236	1777T	607	1838POCKET	244	1874	326	1893TR/CI	260
1760PA/80	234	1778AN	239	1838RA/10-11LED	245	1874-50/5S	326	1895 13	260
1760PA/AC	234	1778AX	240	1838RB/10LED	245	1874-50/FC	326	1895 27	261
1760PA/AC-DC	234	1778BS	240	1838RB/FLASH	244	1875LT	255	1895 6	260
1760PA/AC-DC2000	234	1778CM	240	1838RR/11LED	245	1875SP/K3	255	1895/RC	261
1760PT	235	1778M7	240	1838RV/11LED	245	1877	255	1895/S	260
1760R/TC2	235	1778MT	241	1838SLIM	245	1877A	255	1895G	260
1760S	233	1778P	240	1838SW	246	1877F	255	1897	261

INDICE ALFANUMERICO

1897/CRB	261	1927B/K5	331	1940E10/MT	341	1982/K12V	314	11202A	576
1897/G	261	1927CD	332	1940E10/S...	341	1984 20V/1200BMC	318	11202B	576
1897/MV	261	1927CD/K3	332	1940E10/S5	341	1984 20V/600BMC	317	11202C	576
1898/B	261	1927G	333	1940MT	341	1984/K1200	318	11204A	577
1898/D	262	1927P	332	1940S...	341	1984/K600	317	11204B	577
1898/K40	261	1927P/K3	332	1942A	341	1986/20V-125BMC	319	11208A	577
1898/M	262	1927SP-AM	333	1942LR	341	1986/K20V-125	319	11208B	577
1898/S	262	1927XM	332	1944A	341	1989RCB	321	11210A	577
1899A	262	1927XM/K5	332	1944AR 2	341	1994B 20V-2AH	320	11210B	577
1899SI	262	1928CD	334	1944N	341	1994B 20V-4AH	320	11212A	577
1900M 8X15 - 1900M 10X15	347	1928DA	333	1944PA	342	1994B 20V-6AH	320	11212B	577
1900S 8x10	347	1928DAL	333	1945C	342	1994BL 12V-2AH	315	11214A	578
1914	347	1928K4	333	1945C/G...	342	1994C 20V	320	11214B	578
1915B	347	1928P	334	1945C/GP...	342	1994CB 12V	315	11214C	578
1915C	347	1928XM	333	1945P	342	1995MQ/G1 - G2	291	11216A	578
1915C/L	347	1930A	335	1945P/S...	342	1995MQ/T	291	11216B	578
1915D	347	1930CD	334	1945S	342	1996MQ/GM	291	11218A	578
1915E	347	1930HLA	335	1945S/G...	342	1996MQ/T	291	11218B	578
1915E/XL	348	1930LA	335	1946	343	1996SVG	291	11220A	578
1916G	348	1930LH	334	1946C/T...	343	11001	570	11220B	578
1916GF	348	1930PA	334	1946C4,8	343	11001H	570	11222	579
1916GFE	348	1930ZL	335	1946C7,8	343	11003	570	11230A	579
1916I	348	1931AN10	336	1946KF	343	11011	570	11230B	579
1916JF	348	1931CD10	335	1946KF/M...	343	11011H	570	11232A	579
1916JM	348	1931CD13	336	1947	343	11018	570	11234A	579
1916P	348	1931CD6	335	1947G	344	11019	571	11240A	580
1916S	348	1932B10	336	1947G2	344	11021	571	11240B	580
1917F	348	1932B13	336	1947H	343	11023	571	11242A	580
1917JF	348	1932RS13	336	1948	344	11024	571	11242B	580
1917JM	348	1933	337	1948PR	344	11031=11038	571	11246A	580
1917M	348	1933AN90	337	1949BC	345	11032	571	11248A	580
1917RG	348	1933AN90-H	337	1949BC/RUL	345	11034	571	11248B	580
1917SP	349	1933I	337	1949DGT/2	346	11035	571	11259	580
1917ST	349	1933IH	336	1949F2	345	11037	571	11260	581
1918	349	1933IL	337	1949GPA	345	11038	571	11263	581
1918N	349	1933ILH	337	1949GPN	346	11040	572	11264	581
1918R	349	1933L	337	1949M	346	11045	572	11265	581
1919F1/2	350	1934BV	337	1949P	345	11046	572	11266	581
1919F1/4	349	1934MAV	338	1949R	346	11048	572	11268	581
1919F3/8	350	1934MAV70	338	1949T	345	11049	572	11271A	581
1919FE1/4	349	1935F	338	1949U5	344	11050	572	11271B	581
1919L	350	1936/4A	338	1949U5/A	344	11069	572	11271C	581
1919ML	350	1936/5A	338	1949U5/B	344	11100	573	11276A	581
1919RB-F	350	1936/7A	338	1949U5/C	344	11101	573	11276B	581
1919RB-FE1/4	349	1937	339	1949U5/D	344	11102	573	11276C	581
1919RF-F	350	1937C...	339	1949U5/E	345	11105	573	11300A	582
1919RF-FE1/4	349	1937K...	339	1949U5/F	345	11106	573	11300B	582
1919RM-F	350	1937KC	339	1949U5/G	345	11107	574	11300C	582
1919RM-FE1/4	349	1937KL	339	1949XS	344	11110	574	11300D	582
1919SC	350	1937KL-D	339	1950BZK	346	11111	574	11300E	582
1921B1	330	1937M	339	1951	346	11115	574	11300F	582
1921M1	330	1937M-01=11	339	1951A	346	11116	574	11300G	582
1921M2	330	1937N10	340	1952	347	11120	574	11320	582
1921N3	330	1937N10-GR	340	1956 115-750W	322	11121	575	11411	582
1922P1	330	1937N20	340	1956 125-1400W	323	11125	575	11415B	582
1922P2	330	1937N20-GR	340	1956 230-2400W	323	11130	575	11420B	583
1922P3	330	1937R/P	339	1966/910W	324	11131	575	11431	583
1924B	331	1938	340	1967/800W	324	11132	575	11440A	583
1924CD	331	1938R/L	340	1972/12V-10	315	11135	575	11440B	583
1924F	330	1938R/S5	340	1972/20V-13BMC	316	11140	576	11440C	583
1924XM	331	1940	340	1972/K12V-10	314	11141	576	11450A	583
1927AN	333	1940/C6	340	1972/K12V-COMBO	314	11145	576	11450B	583
1927B	331	1940/S5	341	1972/K20V-13BMC	316	11200A	576	11450C	583
		1940E10	341	1982/12V	315	11200B	576	11488PF	584

11491	584	2400 RSC24/MP	378	338	29	378	34	3026 0,3	268
11493	584	2400 RSC24/PC	377	338R	29	378BA	307	3026 0,5	268
11495	584	2400 RSC24/PD	377	338R/I	29	383	34	3026 1,0	268
11498	584	2400 RSC24/PF	377	338RP	29	383R	34	3026/R 1,0	268
2		2400 RSC24/PF-	377	339A	29	384	34	3026/R0,3	268
		2400 RSC24/PL	377	339A/R	29	384RC	34	3026/R0,5	268
2001/B26	352	2400 RSC24/SPC	378	340	29	386A	34	3026/S	268
2001/BV	352	2400 RSC24AXLP/CPR	376	340C	30	386A/RC	34	3026/SA	268
2001/BZ24 MQ	353	2400 RSC24AXLP/PF	376	340C/KRL	30	386BA	307	3026/SAM	268
2001/BZ27 VU	353	2400 RSC24AXLP/VL	377	340RL	29	387	34	3026/SP	268
2001/BZV	352	2400-COVER RSC24	393	341	30	387R	34	3027/PR	270
2002/BV12	353	2400-COVER RSC24AXL	393	341B	30	388	34	3027N 10	269
2002/BV13	354	2499PC	378	341B/RL	30	388A	34	3027N 100	269
2002/BV42	354	2499PF	378	341B/RM	30	388C/C8	35	3027N 20	269
2002/BV6	9	2499PF/M	378	341RL	30	389/K4	35	3027N 30	269
2002/BV7-ZIP	353		378	342	30	392C	35	3027N 50	269
2002/BV8	353	3		342A	30	392RG/C	35	3027N/KP	269
2002/BV9	353			342A/MOL	30	393	35	3027N/KPP	269
2002/BVL6	353	30	9	342A/RL	30	395	35	3028 15	270
2005MPU	354	30BA	304	342MOL	30	395T	35	3028 20	270
2005MPU/E	354	31	9	342P	30	398	35	3028 30	270
2005PA/D	354	31/B6N	9	342P/RL	30	399	35	3028 50	270
2005PA/E	354	31/B6N-LSE	9	342RL	30	399R/...	35	3028/KP	270
2005PA/ET	354	31 serie	9	345	31	3000L	263	3028SP/15	270
2005PA/S	354	31BA	304	345C	31	3000L/RLS	263	3028SP/20	270
2005PA/U	355	31BA/C	304	345SB	31	3000M/PLM	383	3028SP/30	270
2009N/BV	354	31BM	9	345SB/R	31	3002	264	3028SP/50	270
2028/VV	355	31BM/D6	9	345SB2	31	3002/RLS	264	3029/2T	271
2028E	355	31L	9	345SC	31	3003	264	3029/2T-L/R5	271
2029/VV	355	31SE	9	345SI	31	3003/RLS	264	3029/2T-L/R6	271
2029E	355	32	9	345SI/R	31	3003C	264	3029/2T-L/RP	271
2029EM	355	32AU	9	345U	31	3003C/RLS	264	3029L/2T	271
2032/TE	356	32AUR	10	345U/A	31	3003PRO	264	3030/2T	271
2032/TV	355	32BA	304	349	31	3003PRO/PM	264	3030/2T-R5	271
2033L	356	33LT	10	349/SMAS	31	3003PRO/RGR	264	3030/2T-R6	271
2033L/VV	356	33NR	10	349/SMM	31	3003PRO/RRG	265	3030/2TRP	271
2036/TV	356	34	10	350	32	3003PRO/RT	265	3030H/2T	271
2036E	356	34BA	304	351C	32	3003PRO/SP	264	3033/3T	271
2037/TV	356	35	10	351P	32	3004	265	3033E/3T	272
2038/TV	356	35PM	10	352C/U	32	3006	265	3033S 3T/R2	272
2041UC	357	35PMR	10	352U	32	3006 R/RG	265	3035	272
2051N	357	36	10	355	32	3006 R/RGF	265	3036	272
2055HB	357	37	10	357F3	32	3007	265	3040C	274
2080/D10	357	37PM	10	357R/F3	32	3007 R/RG	266	3040C/S1	274
2080/V12	357	37PMR	10	358	32	3007 R/RGF	266	3040C/S2	274
2080/V12-...	357	38/DS1	611	358RL	32	3008N	266	3041C	274
2080/V6	357	38/DS2	611	359	32	3009	266	3041C/12	274
2080/V6-U	357	38 serie	10	359CH	33	3009R/GR4	266	3041C/16	275
2080/VG	262	39BA	305	360	33	3010/T...	266	3042C	275
2109MT ID/1	360	310	27	360R/...	33	3010H	266	3043C	275
2115P L-MQ32	362	310/C8	28	361N	33	3010V	266	3043C/ 41÷47	275
2115PI/BIKE-HOME	361	310B	27	362	33	3011/T	266	3047C	275
2250-O	262	311	28	362R/...	33	3012	267	3048C	275
2252	262	330	28	363	33	3012C	267	3050/600	275
2252KR4	262	330BA	307	363BA	307	3012I	267	3050/CC	275
2254A	263	330BA/2R	307	363R/...	33	3014	267	3050/KA	275
2254C	263	330R/A	28	365	33	3014 SAR	267	3050/LA	276
2254F	263	330R/I	28	365R/...	33	3014R/GR5	267	3050/MS	275
2254K	263	331C	28	366	33	3014SAR/1	267	3050/MV	276
2254SM	263	332	29	374	33	3014SAR/2	267	3054	276
2254T	263	334	29	374K	597	3014SAR/RR	267	3055M	276
2258N-O	263	334R	29	374R/...	34	3023	267	3057	276
2258RR	263	334R/I	29	375	33	3025N	267	3061/2T	272
2300ST/KIT	370	336	29	376	33	3025N/PF	268	3061/2T-P100	272

INDICE ALFANUMERICO

3061/2T-P50	272	3937	282	410AS/SEL	37	426T/SP	42	450/C21	52
3065/20-10T	273	3948	282	410AS/SP	37	427	44	450/C9	52
3065/40-20T	273	3952	282	410MIX/SEL19	37	428/C14	44	450AD	51
3067/60-15T	273	3952/S	282	412	37	428FC	44	450AL	51
3067/70-13T	273	3953	282	412/C150	38	428FP	44	450PA/1	52
3068	273	3955	282	412/SP	37	429/C14	44	450PA/2	52
3069	273	3961 3,2	282	412/SP91	38	429FC	44	450PR	52
3070B	276	3961 3,3	283	412A	38	429FP	44	451	52
3070B/10	276	3961 3,5	283	412L	38	430	44	451/C	53
3070BE/B	277	3961U	283	412XL	38	430/SP	44	451GA	53
3070BE/F	277	3962MV	283	414	38	430ASC	45	451PA	53
3070BE/K	276	3962SH	283	414/C116	39	430ASW	45	451PR	53
3070BE/S	276	3963P	283	414/SP	38	431	45	452	53
3071A	277	3964	283	415	39	431/SP	45	452GA	53
3071B	277	3965	283	415/C116	39	433	45	460	53
3071RS	277	3965C	283	415/SP	39	433ASF	45	460G	53
3072N	277	3967	283	415/SP91	39	433ASG	45	460PP	53
3073	277	3969	283	415CO	39	434	45	4900-COVER C49	397
3074O	277	3969K3	283	415CO/SP	39	435	46	5	
3074O/2	278	3971	283	415CO-A	39	435G	46		
3074O/M	278	3972	283	415L	40	436	46	52	13
3074O/S	278	3973/1	283	416	40	436L	46	52MQ	286
3075/CM	278	3973/2	284	416/SP19	40	436R	46	53	13
3075/K10	278	3973/3	284	416P/SP19	40	437C	46	55	13
3075A	278	3973/4	284	417	40	437C/...	46	55/B12N	14
3075B 55	278	3973PF	283	417/SP	40	437C/RM14	46	55/B8N	14
3075MV	278	3975	284	419	40	437K/12	47	55/S	14
3079/21	278	3984/1	284	419/SP	40	437K/16	47	55/SP	14
3080/C15	278	3984/2	284	419T	41	437K/33	47	55AS	14
3080R/CS3	278	3984/3	284	421	41	437K/8	46	55AS/S	14
3081	278	3984/4	284	421/SP6	41	437K/9	46	55BA	305
3085	278	3984/5	284	422	41	437P	46	55BA-AS	305
3091	279	3984/6	284	423	41	437U/09	47	55K	596
3092	279	3991	284	423A	41	437U/E-M...	47	55MP	14
3093/E	279	3992	284	424	41	437U/PM	47	55MP/S	14
3093/U	279	4		424/SP	41	438...	47	58	14
3094PA	279			425	41	438A	47	58BA	305
3095	279	42	11	425/SP	41	440	47	58BA-AS	305
3099E	279	42/B	10	426	42	440A	47	560/C12	55
3099T	279	42/B9N	11	426/SP	42	440ASC	48	560/C2	55
3500/P-M	385	42/S	12	426A/SP6	42	440ASF	48	560/C3	55
3700/PC	388	42/SC9I-E	12	426MD/CP	43	440ASG	48	560/C3PLUS	55
3700/PF	388	42/SP_plastica	12	426MD/CT	43	440ASW	48	560/C4+	55
3700/PFL	388	42/SP25	12	426MD/F	43	440B	48	560/C6	55
3700/PLA	388	42AS	12	426MD/FA	43	441	48	561/1	55
3700/PLL	388	42AS/B9N	12	426MD/OG	43	441A	48	562-1/VA - 562-2/VA	56
3700-COVER C37	393	42AS/S	12	426MD/OV	43	441B	48	562VV-A	56
3910	281	42BA	305	426MD/S	43	442	49	564-3R/V - 564-4R/V	56
3912PP	281	42BA-AS	305	426MD/SP10	43	443	49	565-1R/VA - 565-2R/VA - 565-3R/VA	56
3912TP	281	42LMP	13	426MD/T	43	444	49	565-4R/VB	56
3912TP/A	281	42LMP/S	13	426MD/TA	43	444G	49	565-5R/VB	56
3912TP/C	281	42MP	12	426MD-3/A9	43	446/C110	50	565VV-B	56
3912TP/FOX	281	42MP/B9N	12	426MD-3/CP3	42	446/C30	49	567-4R/VB	56
3912TP/QRE	281	42MP/S	12	426MD-3/CT3	42	446/C48	49	567-5R/VB	56
3912TP/ROAD	281	42NEWK	596	426MD-3/F3	42	446ASC/C37	50	581	60
3912TP/RS	281	42SLIM	13	426MD-3/FA3	42	446ASF/C29	50	583	60
3912TP/ST	281	42SLIM/B8NI-E	13	426MD-3/OG3	42	446ASG/C23	50	583/C31	60
3916MMP	282	42SLIM/S11	13	426MD-3/OV3	43	446ASW/C36	50	590 - 592	60
3918MML	282	45	13	426MD-3/S3	43	447/C37	51	594	60
3921	282	410	36	426MD-3/T3	43	447/C53	51	596 - 598	60
3923	282	410/SEL	37	426MD-3/TA3	43	447/C70	51	599DGT	61
3927	282	410/SP	36	426SB	42	450	51	599DGT-AN	61
3932U	282	410A	37	426SB/SP	42	450/C13	52	5000 RSC50/ASL	475
3935	282	410AS	37	426T	42	450/C15	52		

5000 RSC50/CAL	453	5988L/4M	509	6600 M/120	618	6600 M/842	622	720ME/C8	73
5000 RSC50/CLL	453	5988U/7M	497	6600 M/125	618	6600 M/852	622	720MRC	72
5000 RSC50/CTR	476	5988U6/M	510	6600 M/126	618	6600 M/856	622	720RNG	72
5000 RSC50/KFC	453	5989 VEM	517	6600 M/131	618	6600 M/857	622	720S	71
5000 RSC50/MP	453	5990V1	505	6600 M/14	616	6600 M/871	622	720S/SB6	71
5000 RSC50/MPA140	453	5990V3	505	6600 M/174	618	6600 M/878	622	720TC	72
5000 RSC50/PLED	475	6		6600 M/175	618	6600 M/881	622	720TC/S5	73
5000 RSC50/PLED-ST	475			6600 M/217	618	6800 VE	616	720TX	73
5700LAMP	405	600	61	6600 M/218	618	6800BA	670	720TX/C6	73
5902MT	518	601C	61	6600 M/22	616	6800RS	670	720XZN	73
5902MT/AS	519	601CA	61	6600 M/222	618	6888	616	720XZN/C6	73
5902VI	481	603	62	6600 M/223	618	6888B1/2	609	727/C16	75
5904VG/2M	520	604B	62	6600 M/230	619	6888B1/4	609	727/ES16	74
5904VG/2T	521	605DGT/2	62	6600 M/236	619	6888B3/8	609	727/ES16TX	74
5904VG/3	522	605E	62	6600 M/241	619	6888GS	670	727/ES16XZN	74
5904VG/3T	523	606 RIC	63	6600 M/242	619	6888GW	670	727/ES22	75
5904VG/5T	524	606MQ/50	287	6600 M/253	619	7		727/ES22TX	75
5904VI/1T	481	610/5	62	6600 M/27	616				727/ES32
5904VI/2T	482	610L/5	62	6600 M/29	616	73	15	727PI/16	74
5904VI/3T	483	610L/5L	62	6600 M/311	619	73/B13N	15	727PI/16 1/2	74
5904VU/1M	490	611	62	6600 M/315	619	73/S	15	727PI/22	75
5904VU/2M	491	612 ÷ 614	62	6600 M/320	619	78	15	727PI/32	75
5904VU/2T	492	614/50	63	6600 M/326	619	78AS	15	728	75
5904VU/3T	493	615	63	6600 M/327	619	78BA	305	728/15	76
5904VU/4T	494	616 - 617 - 619	63	6600 M/33	616	78BA-AS	306	728/16	76
5905VG/1	525	621	63	6600 M/330	619	710	70	728/21	76
5905VG/2	526	622	63	6600 M/371	619	710/16	70	728/22	76
5908VG/2T	527	641	63	6600 M/380	620	710/20	70	728/22L	76
5908VI/2T	484	642	63	6600 M/40	617	710/21	70	728/25	77
5908VU/2T	495	643	63	6600 M/406	620	710/22	70	728/C10	75
5910VI/3	485	644	63	6600 M/417	620	710/25	70	728/OR - 728/SP	77
5910VI/3T	486	650A	64	6600 M/42	617	710/C10	70	728AS	76
5914VU/M	496	650H	64	6600 M/423	620	710/OR... - 710/SP...	70	728B	75
5915VU/0	498	652	64	6600 M/424	620	720	70	728B/C10	75
5915VU/1	498	653	64	6600 M/427	620	720/15	73	728FTX	76
5915VU/2	499	654	64	6600 M/430	620	720/16	73	728L	76
5915VU/3	499	659/15	64	6600 M/44	617	720/20	74	728L/S	76
5915VU/4	500	659/16	64	6600 M/440	620	720/21	74	728LQ	76
5915VU/5	500	665	64	6600 M/456	620	720/22	74	728LS	76
5915VU/AS	501	665LB	65	6600 M/465	620	720/25	74	728ME	76
5927VU/M	501	665SW	65	6600 M/47	617	720/C12	70	728ME/C6	76
5935ET/1MB	511	666	66	6600 M/480	620	720/C24	71	729	77
5935VG/1MB	528	666 LBF.FT	66	6600 M/485	620	720/C6	70	729/15	64
5935VI/2MB	487	667	66	6600 M/51	617	720/OR... - 720/SP...	74	729/16	77
5938U/2T	502	668N	66	6600 M/510	621	720/SN	73	729/21	77
5940SBK	528	668RG	67	6600 M/52	617	720AS	71	729/21L	77
5941VU/M	529	668RGC	67	6600 M/532	621	720B	71	729/22	77
5945VUM_2024	530	669N	67	6600 M/534	621	720B/C12	71	729/25	77
5954VG	531	671B/C10	67	6600 M/542	621	720FRD	72	729/OR... - 729/SP...	77
5954VI	489	671B/C5	67	6600 M/548	621	720FTX	73	729L	77
5957U-P	503	671N/C10	67	6600 M/561	621	720FTX/SB	73	729LS	77
5957VG	532	671N/C20	68	6600 M/58	617	720IC	72	729T	77
5957VI	488	671N/C30	68	6600 M/583	621	720L	71	730	78
5958U	504	674/C	68	6600 M/59	617	720L/S3	71	730/15	78
5980/MQ	513	677	68	6600 M/61	617	720LC	72	730/21	78
5980EL/A	514	677/C	68	6600 M/62	617	720LC/C3	72	730/25	78
5980EL/B	515	677/CP2000	68	6600 M/63	617	720LC/PM5	72	730L	78
5980ET/A	512	677/CV - 678/CV	69	6600 M/643	621	720LC/S5	72	733/15	78
5980ET/B	513	678/C	69	6600 M/650	621	720LCL	72	7041LCD/4S	254
5980ID/1	516	680	69	6600 M/657	621	720LCL/C3	72	7041LCD/4S-VE	254
5980U/BIKE	506	682	69	6600 M/658	621	720LS	72	7041LCD/4S-VI	254
5980U/BIKE-M	507	6200AP/S10	670	6600 M/716	622	720MC	71	7042LCD	254
5988 VHB-MQ	514	6600 M/112	618	6600 M/73	617	720MC/C13	71	7042LCD/RV	254
5988H/7M	508	6600 M/116	618	6600 M/813	622	720ME	73	7042LCD/RV-INT	254

INDICE ALFANUMERICO

7043	254	7356G	644	7657N	664	7979	667	862PH/L	82
7061TC	669	7356LN	644	7658CM	662	7980L	668	862PH-XL	82
7076BC	669	7356V	644	7659N	662	7980NC	668	862PZ	82
7076BD	669	7357G	644	7660B	653	7980RN	668	862TX	82
7076BP	669	7357V	645	7660G	653	7981N	668	862TX/L	82
7076BU	669	7362B	645	7661B	657	7982N	668	862TX-XL	82
7093BC	669	7363N	645	7661G	657	7984EG	668	862XP/A16	83
7093BD	669	7371V	645	7664G	664	7984G	668	866LP	83
7104 90	668	7372B	646	7664N	664	7985N	668	866PE	83
7105 6	668	7376A	646	7665G	664	7996N	667	866PH	83
7109A	668	7381N	646	7665N	664	8		866PZ	83
7109D	668	7382N	646	7669N	662				866RTX
7201BKK	637	7398 0/G	648	7670G	662	80	15	866TX	83
7210BKK	637	7398EF	649	7673NG	661	80/S	15	867/...	84
7212B	634	7398ESD	648	7674NG	663	83	15	867/C20	84
7212G	635	7398GEL	648	7750N	663	83/S	15	867/C38	84
7213G	635	7398T	648	7780QN	663	83AS	16	867/C52	85
7214FN	635	7398U	648	7800G	668	83AS/S	16	867PE	83
7214G	636	7398UP	648	7815CM	657	88	16	867PE/L	83
7215FN	636	7399 A/N...	649	7818BL	654	88/S7	16	867RIBE	84
7216BKK	637	7421	649	7818CM	654	89BA	306	867RIBE/L	84
7218FN	636	7422P	649	7818G	654	89MQ	286	867RTX	84
7218G	636	7425	649	7818LN	654	850MQ	287	867RTX/L	84
7220PEK	633	7426P	649	7819G	654	851	78	867TX	84
7221PEK	633	7427	649	7830SN	654	851SR	78	867TX/L	84
7222PEK	633	7430T	649	7830ST	655	852	79	867XZN	84
7223PEK	634	7431P	649	7831SN	657	855P	79	867XZN/L	84
7236BK	638	7527	652	7831ST	657	855P	598	882	85
7238WR	638	7528	652	7840BL	655	860/55	79	882AN	85
7241BK	630	7529	657	7849BL	660	860/58	79	882M	85
7241CK	630	7530	652	7850G	655	860/58K	598	882M1	85
7241EN	629	7545F	664	7860B	655	860/C27	79	882MSR	85
7243BK	630	7547AZ	664	7860G	655	860/C38P	80	882P	85
7243CK	631	7547BL	665	7861B	658	860LP	79	892	85
7243CR	631	7547G	665	7861G	658	860MIX/A10	80	895	85
7243EN	629	7547N	665	7863G	658	860MIX/A31	80	897	85
7243FT	631	7547R	665	7865B	659	860PE	79	897L	85
7245BK	631	7548C	665	7865G	659	860PE/A10	80	8001TZ	675
7246BK	632	7548M	665	7867B	661	860PH	79	8001TZ-K	675
7246E	629	7549AZ	665	7867G	661	860PHZ/A10	79	8001Z	675
7247BK	632	7549BL	665	7869G	660	860PZ	79	8001Z-K	675
7249GK	638	7549G	665	7880SC	655	860RTX	79	8002ZD	676
7293HM	647	7549N	666	7900B	656	860TX	79	8002ZS	676
7294HM	647	7549NE	666	7900G	656	860TX/A10	80	8003ZD	676
7294HMC	647	7549R	666	7900P	656	861/C61P	82	8003ZS	676
7314AF	639	7550G	666	7900V	656	861LP	80	8004ND	676
7315AN	639	7550N	666	7901G	658	861PE	81	8004NS	676
7316NB	639	7557BL	666	7903G	659	861PH	80	8005TZ	673
7316NG	640	7575N	661	7903P	659	861PH/C	80	8005TZ-K	673
7317NA	640	7579QN	661	7905G	659	861PZ	80	8005Z	673
7318AN	640	7600G	652	7907G	662	861PZ/C	81	8005Z	673
7320NA	640	7600N	652	7909B	660	861RIBE	81	8005Z-K	673
7321NA	641	7610G	653	7909G	660	861RTX	81	8006Z	673
7322SA	641	7610N	653	7909P	660	861SP	81	8006Z	673
7323SA	641	7611G	657	7909V	660	861TQS	81	8006Z-K	673
7328A	632	7636N	663	7930MG	656	861TRW	81	8007Z	674
7328N	632	7637G	663	7931MG	658	861TX	81	8007Z-K	674
7352A	642	7642G	663	7935MG	659	861TX/C	81	8008N	674
7352B	642	7650	653	7937MG	662	861XZN	81	8008N-K	674
7352G	642	7650B	653	7940	656	862F	83	8008TZN	674
7352LG	643	7653G	660	7949	661	862F/A7	83	8009FD	677
7353Y	643	7654B	663	7970	666	862LP	82	8009FS	677
7354N	643	7654N	664	7971L	667	862PE	82	8009TZ	674
7355V	643	7657B	664	7978L	667	862PH	82	8009TZ-K	674

INDICE ALFANUMERICO

8009Z	674	8060R/PS	698	8147P	693	8206	700	8600 R/12	622
8009Z	674	8061R - 8061F	691	8147S	693	8207	700	8600 R/13	623
8009Z-K	674	8062	692	8148	694	8209	700	8600 R/225	623
8010TZ	675	8063	691	8148/RA	699	8210	700	8600 R/412	623
8010Z	675	8063SL	691	8148/RKCL	699	8210F	701	8600 R/511	623
8010Z-K	675	8064S	691	8148/RKCM	699	8210FTP	701	8600 R/601	623
8011TZ	675	8065SC	692	8148/RKG	699	8216	701	8600 R/611	623
8011Z	675	8068S	683	8148/RKS	699	8216	701	8702N	677
8015	678	8074	695	8148/RP	699	8216-K	701	8702Z	677
8016	678	8074	695	8148F	694	8220	702	8702ZC	677
8016	678	8074A	695	8149	699	8225	702	8709N	678
8016FR	679	8074G	695	8149CM	699	8225	702	8709Z	678
8016-K	678	8080	695	8149CM/RA	699	8227	702	8709ZC	678
8016U2	679	8080FM	695	8150	706	8228	702	8889C1	559
8016UGK	679	8082	695	8153	707	8240	702	8889C2	559
8016U-K	679	8083	696	8156	707	8240F	702	8889C3	559
8018E	679	8085R	690	8157	707	8242	703	8889C6	560
8018T	679	8086	690	8158	707	8242F	703	8889CD	560
8020	680	8090F	710	8159	707	8248	701	8889CS	560
8020A	680	8090R - 8090	690	8160	707	8249	701	8889I4	559
8021A	680	8091	686	8161	708	8249G	701	8889P1	559
8025	681	8091SL	686	8166	710	8250	704	8889P2	559
8025	681	8092	686	8170	708	8264	704	8889P3	559
8025-K	681	8092SL	687	8173	708	8267	704	8889P4	559
8026A	682	8094	687	8176	708	8272	705	8889PD	560
8026A-K	682	8094SL	687	8177	708	8273	705	8889PS	560
8026R	680	8096	688	8178	708	8274	703		
8026R-K	680	8096SL	688	8179A	709	8274	703	9	
8028	682	8097	688	8179B	709	8274A	703	90	16
8028-K	682	8097SL	689	8179M	709	8274G	703	90/B8N	16
8029R	680	8098	689	8180	710	8276	703	90/S	16
8029R	681	8098SL	689	8181	710	8276G	704	90/SP	16
8029R-K	681	8100	690	8181 6/S4	710	8278	704	90AS	16
8031R	681	8105	672	8181S	710	8279	706	90AS/S	16
8031R-K	681	8105-K	672	8182	711	8280	704	90BA	306
8032	681	8109	672	8182 8,5/S2	711	8282S	705	90K	596
8032-K	681	8109-K	672	8182A	711	8284	705	91	17
8040EN	684	8110	672	8182E	710	8285	705	91BA	306
8040EN-K	684	8114	696	8182GD	711	8286	705	92	17
8040EZ	684	8116	696	8182H	711	8287	705	92BA	306
8040EZ	684	8120	694	8182H/2	711	8290	705	93	17
8040EZ-K	684	8120B	694	8182S	711	8293	706	93BA	306
8041	683	8120D	694	8182T	710	8297C	706	93C	17
8041-K	683	8120DZC	694	8182TS	710	8297F	706	93K	596
8042EN	685	8121MZC	694	8183	711	8302Z	677	94	17
8042EN-K	685	8129	695	8184	711	8302Z	677	94/S	17
8042EZ	685	8130	695	8185	712	8303Z	677	94K	596
8042EZ	685	8134	692	8186	712	8303Z	677	95	17
8042EZ-K	685	8135	692	8187	712	8317DZ	696	95/S	17
8043	684	8135/KLA1	698	8188/K8	713	8317SZ	696	95BA	306
8043-K	684	8135/KMO	698	8188C	712	8381SL	696	95FTX	17
8044	685	8143	692	8188CG/25	712	8381SP	696	95FTX/S	17
8048	677	8143/RKCI	698	8188CU/25	713	8381SX	706	96	18
8049	682	8143/RKL	698	8188F	713	8383C	697	96/B	18
8049A	683	8143/RPC	698	8188F35	713	8383P	697	96/BG7	18
8049V	683	8143/RPF	698	8188VFG2	713	8515CH	697	96/BGS7	18
8050 D	697	8146	693	8189	713	8515V	697	96/SC12	18
8051S	692	8146/RK	698	8189A	713	8515Z	697	96/SC9	18
8051S-K	692	8146/RKCI	699	8189PA	713	8531	697	96/ST	18
8052 - 8055S	691	8146/RKFC	698	8190	712	8532	697	96/ST6K	596
8057R - 8057	691	8146/RKL	698	8190B	712	8535	697	96AS	19
8058R - 8058	690	8146/RPC	698	8201T	701	8600 R/11	622	96AS/B	19
8058R/PS	698	8146C	693	8205	700	8600 R/113	623	96AS/BG7	19
8060R - 8060	690	8147C	693	8205	700	8600 R/114	623	96AS/SC9	19

INDICE ALFANUMERICO

96AS/T	19	97TX/G	22	900MB/L	87	910B/C10	98	920/46	104
96BA	306	97TX/SC8	22	900MB/SB	86	910B/C16	98	920/50	104
96BA/BP	306	97TX/ST	22	900MC	86	910B/C16Q	98	920/50F	104
96BAF-AS	307	98XZN	23	900MC/C24	92	910B/C29	99	920/55	104
96BP	20	98XZN/B	23	900MC/C32	92	910B/SB	94	920/55K	599
96BP/AS	21	99	23	900MC/LP	87	910B/SN	94	920/55LC	105
96BP/ASB	21	99 VN/...	24	900MC/PH	88	910BL	94	920/55Q	104
96BP/AS-SC9	21	99BA	307	900MC/TX	88	910BL/SB	94	920/55X	105
96BP/SC9	20	99SQ	24	900ME	88	910BP	96	920/56A	105
96BPA	21	99ST	24	900ME/SB8	88	910BP/SB6L	96	920/58	105
96BPA/SC9	21	900	86	900PE/AS	88	910CF	96	920/58K	599
96BPA/SC9	596	900/...	89	900PH	88	910CF/SB	96	920/C37	107
96BPC	20	900/16	88	900PH/SB4	88	910FTX	95	920/R50	111
96BPC/SC9	20	900/20LK	598	900PT	88	910FTX/L	95	920/R55	111
96BPC/SC9	596	900/25	89	900PZ	88	910FTX/LSB	95	920/R55LC	112
96BP-CL	20	900/25K	599	900T/44	89	910FTX/SB	95	920/R55Q	111
96BP-CL/SC9	20	900/32	89	900TX	88	910FTX/XL	95	920/R55X	112
96BP-CL/SC9	596	900/35A	89	900TX/SB	88	910FTX-XL/C10	95	920A	99
96C/AS	19	900/40	89	900U	87	910LP	95	920A/AS	100
96C/AS	596	900/42	89	900U/C12M	92	910M/35	97	920A/C11	105
96C-AS/SC9	19	900/55	89	900U/SB	87	910M/35L_WARN	104	920A/C12	105
96L	20	900/55K	599	902A/C22	93	910M/55	97	920A/C12X	105
96L/SC12	20	900/55Z	90	902R/C6	93	910M/56	98	920A/C17HR	108
96L/SP8	20	900/55ZK	599	910/15	96	910M/R55	111	920A/C17M	107
96LBP	20	900/58	90	910/16	97	910ME	96	920A/C17MR	107
96LBP/SC9	20	900/58K	599	910/20 - 910/21 -	97	910ME/SB	96	920A/C20	106
96LBP/SC9	597	900/C11	90	910/22		910MQ/21	287	920A/C20Q	106
96LC	19	900/C11HR	93	910/21K	599	910MQ/22	287	920A/C20X	106
96LC/SC12	20	900/C11Z	91	910/25	97	910MQ/55	287	920A/C21	106
96LC/SC8	20	900/C12MR	91	910/25K	599	910MQ/B	287	920A/C21X	106
96N	18	900/C12MZ	91	910/36A	97	910MQ/C16	287	920A/C33	107
96N/B	19	900/C13-5	91	910/40	97	910MQ/PE	287	920A/SB13	99
96N/G	19	900/C13-8	91	910/42	97	910MQ/PT	287	920A/SB8	99
96N/SC12	19	900/C24	92	910/46	97	910MQ/T	287	920A-AS/SB11	100
96N/SC9	19	900/C39N	90	910/55	97	910MQ/TX	287	920AK	599
96N/ST	19	900/C39U	90	910/55K	599	910MQ/XZN	287	920AL	100
96N/ST6K	596	900/R55	111	910/55Q	97	910PE	96	920AL/SB11	100
96T	21	900/R55-Z	111	910/58	98	910PE/AS	96	920AN	103
96T/AS	21	900/SB	86	910/58K	599	910PE/SB	96	920AS	100
96T/S11	21	900AN	89	910/R55	111	910PH	95	920AS/C10	108
96T/S6	21	900AS	87	910/R55Q	111	910PH/SB4	95	920AS/C15	108
96T/SP	21	900AS/C10	93	910/R55X	111	910PT	96	920AS/C17X	108
96T/SPV	561	900AS/C17-MBM	93	910A	93	910PT/SB	96	920AS/L	101
96TAS/S	21	900AS/L	87	910A/AS	94	910TX	96	920AS/MBM-C21	108
96TBP	22	900AS/MB	87	910A/C10	98	910TX/SB	96	920AS/SB11	100
96TBP/S6	22	900AS/MB-C17	93	910A/C16	98	910XZN	96	920ASL/SB11	101
96TK	597	900AS/MBL	87	910A/C16HR	99	911BA	307	920B	100
97BRTL/SC8	23	900AS/SB11	87	910A/C16Q	98	911BA/16	307	920B/C11	105
97BTX	22	900BG/30	89	910A/C17	98	911BA/20	307	920B/C12	106
97BTX/B	22	900BG/30C	89	910A/C29	99	911BA/55	307	920B/C12X	106
97BTX/SC8	22	900BG/30K	599	910A/SB	93	914MQ/A	288	920B/C20	106
97BTX-C	22	900FL	89	910A-AS/SB13	94	914MQ-A/S4	288	920B/C20X	106
97BTX-C/SC8	22	900FTX	87	910AK	599	920/15	103	920B/C21	106
97BTXL	23	900FTX/SB9	87	910AL	94	920/16	103	920B/C21X	107
97BTXL/SC8	23	900K	598	910AL/SB14	94	920/20+920/23	103	920B/C30Q	107
97RTX	23	900L	86	910AN	97	920/21K	599	920B/C33	107
97RTX/B	23	900L/SB	86	910AS	94	920/25	104	920B/SB13	100
97RTX/SC8	23	900LP	87	910AS/C13	99	920/25K	599	920B/SB8	100
97TTX	23	900M/35	89	910AS/L	95	920/35A	104	920BL	100
97TTX/S	23	900M/55	90	910AS/MBM-C18	99	920/36A	104	920BL/SB11	100
97TTX/SP	23	900M/R55	111	910AS/SB13	94	920/38	104	920BP	102
97TX	22	900MB	86	910AS/SN	95	920/40	104	920BP/SB	102
97TX/B	22	900MB/C19	91	910ASL/SB12	95	920/42	104	920ES	103
97TX/BG8	22	900MB/C28	92	910B	94	920/44	104	920ES/SB	103

INDICE ALFANUMERICO

920ES/XL-SB	103	928/16	109	951AS	115	960YP	121	999E	127
920FTX	101	928/20 - 928/21 -	109	951AS/S	115	961BA	309	999G	127
920FTX/C	101	928/22		951BA	309	961P6	122	9500TL	715
920FTX/L	101	928/25	109	951GP	115	961P6/S	122	9501TL	715
920FTX/LSB	101	928/36A	110	951GP/S6	115	962	122	9501TLD	715
920FTX/SB	101	928/42	110	951K	600	962C	122	9502TL	716
920LH/SB7	101	928/55	110	951MQ	288	962M	123	9503TL	716
920LP	101	928/R55	112	951TX	116	962P	123	9504TL	716
920M/35	104	928/R55X	112	951TX/S	116	963	123	9505TL	716
920M/35L	104	928A	109	952	116	963BA	309	9510W	716
920M/55	105	928AS	109	952/D7	116	964	123	9520P	718
920M/56	105	928AS/C12	110	952/S	116	964BA	309	9521	718
920M/R55	111	928B	109	952AS	117	964BA/L	309	95210B	719
920MC	100	928B/C12	110	952FTX	117	965	123	9522A	724
920MC/C14	106	928ME	109	952FTX/S	117	965/S	123	9523A	724
920ME	102	929	110	952L	117	965BA	309	9523T	721
920ME/C	102	929/15	110	953	117	966/C3	123	9524SC	721
920ME/SB	102	929/21 - 929/22	110	953/S	117	966BA	309	9525CM	718
920MQ/21	288	929/42	110	953TX	117	966BA/V	309	9525TR	718
920MQ/22	288	929/55	110	953TX/S	117	969/C5	123	9525WB	718
920MQ/55A	288	929/55PR	111	955	118	969B	123	9526F	719
920MQ/A	288	929/C8	111	956C	118	970B	123	9526P	724
920MQ/C16	288	929/R55	112	956E	118	970IVECO	123	9526RMN	724
920MQ/PE	288	930	112	956F	118	971/C8	124	9527 6T	724
920MQ/T	288	930/C	112	956L	118	972/C10	124	9528B	721
920PE	102	930/S	112	957	118	972/C4BMW	124	9534BO	716
920PE/AS	102	932	112	959	119	973	124	9534WO	716
920PE/C	102	932/S	112	959R	119	978 - 979	124	9537TL	716
920PE/SB	102	933	112	960	119	982	124	9539CB	720
920PE-AS/SB6	102	933/S	112	960/22EP	120	983 PM/R-DA	124	9541BIKE	718
920PH	101	935	113	960/C6	120	983PM	124	9541F	718
920PH/SB4	101	935/S	113	960/D	120	984	124	9541PC	718
920RTX	103	935K	599	960A	119	985/B7	124	9541S	718
920RTX/SB	103	937	113	960AD/TP2	175	985F	125	9542AL	721
920TX	102	937/S	113	960AVE	121	985M	125	9542AT	720
920TX/C	102	937BA	309	960BC/C5	119	986 48	125	9542C	720
920TX/C17	108	937K	599	960EPC/L	121	986 78	125	9542G	720
920TX/L-SB4	102	940	113	960E-PI/P	121	986PT	125	9542GW	720
920TX/SB	102	941	113	960ER	119	987	125	9542M	720
920U	101	941/S	113	960F	119	987AR	125	9542S	720
920U/C17M	109	942BX	113	960G	119	987P	125	9543C	721
920U/SB13	101	942BX/DG	611	960H/C4	119	988/K4	125	9544C	717
920U/SB4	101	942BX/S	113	960KC-M8/M9/M10	121	989	125	9547	724
920XZN	103	943BX	114	960KPC	121	989A	125	9547T	721
920XZN/LS	103	943BX/D	114	960L	119	989B	125	9547WSK	721
920XZN/SB12	103	943BX/DG	611	960M	119	990	126	9548G	722
920XZN/SB7	103	943BX/S	114	960P	121	991	126	9548KB	721
921BA	308	943BXK	600	960PI	121	992	126	9548KB 20	721
921BA/15	308	943FL	114	960PI/C19	122	993	126	9548KB 24	721
921BA/16	308	943FL/S	114	960PI/K36	122	993G	126	9549ABW	723
921BA/21 - 921BA/22	308	943MQ	288	960PI/S	122	993MQ	289	9549BP	723
921BA/25	308	943MQ/BG	611	960PMC	122	993PL	126	9549BRW	724
921BA/42	308	943MQ/S	288	960RPI	122	994	126	9549C	724
921BA/50	308	944BX	114	960SL	119	994MQ	289	9549CR	723
921BA/R50	308	944BX/D	114	960SN	119	994PL	126	9549MPC	723
921BA-AS	308	944BX/DG	611	960T/A	120	994TF	126	9549SBW	723
926BA	308	944BX/S	114	960T/B	120	996	126	9557J 2.0	717
926BA/15	308	949	114	960T/C	120	998	126	9557N	717
926BA/22	308	949/S6	114	960T/C11	120	999	126	9559	722
926BA/42	308	950	114	960T/F	120	999/B6N	127	9559/30MT	722
926BA/50	309	950/S	114	960T/G	120	999A	126	9561V	722
926BA/R50	309	951	115	960T/H	120	999B	126	9561V 2,5	722
928.../C12	110	951/S	115	960UC	121	999C	126	9561VV	722
928/15	109	951/SP	115	960VTC	122	999D	127	9561VV 2,5	722

INDICE ALFANUMERICO

9562P12	726	C8 - 2108	359	C45PRO CAI/X	472	C55AB	413	C58M	407
9562P2	726	C8B	359	C45PRO CORNER/W	472	C55AC	431	C58P	405
9562T1	276	C9 - 2109	359	C45PRO CORNER/X	471	C55AE	430	C59A	408
9562T2	409	C9/RT	359	C45PRO CPF	463	C55AT1	435	C59B	408
9562T3	276	C9DA	359	C45PRO CW	460	C55AT2	435	C59C	409
9562TB	670	C9MT	360	C45PRO CX	460	C55B PT/2	420	C62M/WW	669
9563G	723	C9PT	321	C45PRO DW	455	C55B PT/2,8	420	C64/1	669
9563U	723	C10 - 2110	360	C45PRO DX	454	C55B/1	432	C64CW	670
9565K	723	C10S - 2110S	360	C45PRO EW	459	C55B/2	415	C64G/1	670
9565S	670	C11 - 2111	360	C45PRO EX	459	C55B/2,8	416	C68	615
9565T	723	C12 - 2112	361	C45PRO FW	455	C55B/G	418	C68 G	615
9569MS	725	C13	361	C45PRO FX	455	C55B/GAA	418	C68N	615
9569MS-2	725	C14	361	C45PRO GW	456	C55B/GAE	419	C88 R/1	615
9569P	725	C16 - 2116	362	C45PRO GX	456	C55B/GDP	418	C88NR/1	615
9569S	725	C18 - 2118	362	C45PRO HW	457	C55B/GDS	418	C88SE	615
9572LB	716	C19 - 2119 - C19L - 2119L	362	C45PRO HX	457	C55B/GE	419	C88VE	615
9574B	718	C20 - C20L - 2120	362	C45PRO M3A	468	C55B/VS	420	C99	364
9574O	718	C20TSS	363	C45PRO M4	465	C55B-D4	417	C99C-V3	367
9577R	722	C22B	363	C45PRO M5	465	C55C7	421	C99P	367
9579C	722	C22P	363	C45PRO M7	466	C55C8	422	C99P12-V0	365
9580S	717	C22W	363	C45PRO M7A/W	462	C55CS	424	C99PC	367
9586K	724	C25	380	C45PRO M7A/X	462	C55KAI	431	C99PP	367
9587 13x21	725	C27S	381	C45PRO M8	466	C55KAS	431	C99V0	364
9587 9x14	725	C30M	383	C45PRO MA	467	C55M2	422	C99V0-P12	365
9588/10PI	725	C35/6GM	384	C45PRO MAL	467	C55M4	423	C99V1	365
9588M	725	C35/7GM	385	C45PRO MAT	468	C55M7	423	C99V2	366
9588S/10...	725	C35/8GM	385	C45PRO ML	468	C55M8	424	C99V3/2C	366
9589A/36	726	C35/9GM	385	C45PRO MP	471	C55MA	425	CA49-G	397
9589B/36	726	C37/6	387	C45PRO MS	466	C55MDO	425	CB/2	561
9590B	722	C37/7	386	C45PRO MWS/W	463	C55MP	431	CB52	400
9592B/C50	724	C37/8	387	C45PRO MWS/X	462	C55MS	426	CD23S	369
9592B/P	724	C37A/7	387	C45PRO PAS	470	C55P/2MDX-SX	427	CP	477
9592M/50	724	C38	389	C45PRO PF	470	C55P/MCD	427	CP15 - 2115	361
9592MB	724	C38C	390	C45PRO PFE	471	C55PB/3	413	CP15L - 2115	361
9593A	717	C38L	389	C45PRO PM	472	C55PB-PRO/7	414	CP17 - CP17L - 2117	362
9593M	717	C38L A	389	C45PRO PML	473	C55PB-PRO/8	414	CP51	400
9593S	717	C38T	390	C45PRO RD/X	467	C55PFA-0,8	429	CPMB/3C	476
9593SB	717	C39/6	392	C45PRO SL	470	C55PFA-1,0	427	CPMB/5C	477
9593W	717	C39/7	391	C45PRO SS	470	C55PM	427	CX49-G	397
9594	724	C39/8	392	C45PRO T3	469	C55PM/M0,8	429		
9595C	725	C39MD	394	C45PRO TC	469	C55PRO B/2	415	G,K	
9595T	725	C39SM	394	C45PRO W	457	C55PRO B/2,8	416	GM	560
9596	725	C39T	392	C45PRO X	456	C55PRO B-D4	417	KIT 6VC/3C	476
9597P	721	C41H	395	C45PW/1-0,7MT	463	C55PS	430	KIT 10VC/5C	477
9597TRIOWAY	719	C41H/CE	395	C45PW/2-1,3MT	464	C55PSE	430	KIT/GPS	560
9598WHP-N	719	C41S	395	C45PW/3-2,0MT	464	C55PT0,8x0,6	429		
9598W-N	719	C42H	396	C45PX/1-0,7MT	463	C55PT1,0x0,6	428	M	
9599CB-N2	719	C45PRO A1/R600	473	C45PX/2-1,3MT	464	C55PTE-0,8	429	M01	533
9599CB-WN	719	C45PRO A1/RB600	474	C45PX/3-2,0MT	464	C55PTE-1,0	428	M02	533
9881U	261	C45PRO A2/R915	474	C45STR	474	C55RB	420	M05	533
9882R	261	C45PRO ACT	469	C48M	398	C55STR	435	M06	533
9899 CV/A	111	C45PRO AS1	473	C48P	398	C55T3	426	M13	533
9899 CV/B	111	C45PRO AS2	474	C51	399	C56	406	M25	533
9899 CV/C	111	C45PRO AW	458	C54S	402	C56B	406	M30	533
		C45PRO AX	458	C55	412	C56M	407	M31	534
		C45PRO BPW-1,3	461	C55 A1/RB42	433	C56P O	401	M33	534
C04TSS-7	380	C45PRO BPW-2,0	461	C55/1PF	429	C56PL O	401	M38	534
C3	358	C45PRO BPX-1,3	461	C55/2PM	428	C56W	406	M39	534
C4 - 2104	358	C45PRO BPX-2,0	460	C55/PF	427	C57SA	403	M40	534
C5 - 2105	358	C45PRO BW	459	C55/PL-1,024	420	C57SB	404	M44	534
C5S	358	C45PRO BX	458	C55A1	433	C57SC	404	M45	534
C6T - 2106	358	C45PRO C5	464	C55A1/R42	433	C57SD	403	M46	534
C7 - 2107	358	C45PRO C7	465	C55A2	434	C57SP	405	M49	534
C7AT	359	C45PRO CAI/W	472	C55A2/R70	434	C58B	407	M50	534

INDICE ALFANUMERICO

M52	535	M236	541	RSC24AXL/9	375	SPG11 - S1203/8	561	T160	554
M53	535	M237	542	RSC24AXLP/7	376	SSPE	473	T161	554
M55	535	M240	542	RSC24L/7	379	ST2P	560	T164	554
M60	535	M264	542	RSC24L-CAB	379	T		T167	554
M62	535	M284	542	RSC28	382			T168	554
M63	535	M292	542	RSC50	439	T01	549	T170	554
M65	535	M294	542	RSC50 A	441	T05	549	T171	554
M67	535	M295	542	RSC50 A1	452	T06	549	T172	555
M69	535	M305	542	RSC50 A1/R59	452	T18	549	T173	555
M75	535	M310	542	RSC50 A1/RB59	452	T19	549	T175	555
M78	536	M400	543	RSC50 A2	452	T22	549	T176	555
M79	536	M401	543	RSC50 A2/R91	453	T23	549	T177	555
M82	536	MB	560	RSC50 AC	451	T31	549	T180	555
M83	536	MB12	544	RSC50 B	441	T33	550	T183	555
M85	536	MB37	544	RSC50 C	441	T34	550	T198	555
M86	536	MB38	544	RSC50 C5	443	T40	550	T199	555
M91	536	MB39	544	RSC50 C7	443	T41	550	T201	555
M92	536	MB44	544	RSC50 C8	444	T45	550	T202	555
M94	536	MB45	545	RSC50 CS	447	T46	550	T204	555
M96	536	MB46	545	RSC50 D	440	T48	550	T205	556
M100	537	MB47	545	RSC50 E	440	T50	550	T206	556
M105	537	MB56	545	RSC50 F	440	T52	550	T207	556
M108	537	MB58	545	RSC50 G	439	T55	550	T208	556
M110	537	MB59	545	RSC50 H	439	T59	550	T209	556
M112	537	MB63	546	RSC50 I	438	T63	550	T211	556
M115	537	MB64	546	RSC50 KAI	451	T64	551	T213	556
M120	538	MB65	545	RSC50 KPF	449	T65	551	T216	556
M121	538	MC10	543	RSC50 L	438	T68	551	T221	556
M125	538	MC12	543	RSC50 M10	445	T73	551	T226	556
M126	538	MC20	543	RSC50 M4	444	T75	551	T227	556
M127	538	MC21	543	RSC50 M5	444	T76	551	T228	556
M128	538	MM11	546	RSC50 M7	445	T77	551	T231	557
M129	538	MM26	546	RSC50 M8	445	T80	551	T233	557
M133	538	MM30	546	RSC50 MA	447	T81	551	T234	557
M134	538	MM60	546	RSC50 MDO	448	T82	551	T236	557
M135	539	MM63	546	RSC50 ML	447	T83	551	T239	557
M136	539	MM100	547	RSC50 MS-2AVV	446	T85	552	T241	557
M137	539	MM105	547	RSC50 MS-2C	446	T91	552	T259	557
M145	539	MM129	547	RSC50 MS-AVV	446	T92	552	T264	557
M153	539	MM210	547	RSC50 MTP	450	T99	552	T270	557
M161	539	MM230	548	RSC50 P/1-0,7MT	442	T100	552	T273	557
M162	539	MM400	548	RSC50 P/2-1,5MT	442	T101	552	T279	558
M166	539	MM401	548	RSC50 P/2MDX-SX	450	T102	552	T281	557
M170	539	P		RSC50 P/3-2,2MT	442	T103	552	T284	558
M172	539				RSC50 PFI	449	T105	552	T291
M174	540	PM 1/2-Q5	72	RSC50 PFS	449	T106	552	T294	558
M180	540	PM/5C	477	RSC50 PM	450	T111	552	T297	558
M195	540	PM/6C	477	RSC50 PS	451	T112	553	TSPP	560
M201	540	PV	405	RSC50 RB	443	T113	553	V	
M204	540	R		RSC50 T3	448	T122	553		VE1
M208	540				RSC51	399	T123	553	VP-3SC
M209	540	RSC22	368	S		T124	553	VP-LD	559
M213	540		RSC23		369		T135	553	VP-LS
M214	540	RSC23C	369	S42/17	561	T136	553	VP1 - VP2	559
M216	540	RSC23T	370	S55/12	560	T137	553	VP3 - VP4	559
M217	540	RSC24/5	372	S55/8	560	T138	553	VP5	559
M218	541	RSC24/6	372	S951/6	561	T140	553	VP6	559
M219	541	RSC24/7	371	S952/10	560	T144	553	VPM0	548
M222	541	RSC24/8	372	S96T/8	561	T145	553	VPM3	548
M226	541	RSC24A/6	373	S1719BM	561	T146	554	VPM7	548
M227	541	RSC24A/7	373	SB	560	T151	554	VPM7-C	548
M230	541	RSC24A/8	373	SGN	561	T153	554	VPM8	548
M231	541	RSC24AXL/7	374	SP5S	478	T156	554	VPM9	548
M234	541	RSC24AXL/8	375	SPC	478	T157	554		

CONDIZIONI GENERALI DI VENDITA

Gli ordini trasmessi per l'acquisto di prodotti dalla Beta Utensili SpA (d'ora in poi "Beta" o "Società") comportano l'accettazione automatica e senza riserve delle presenti Condizioni Generali di Vendita che costituiscono parte integrante del contratto di vendita. Eventuali deroghe alle stesse saranno efficaci solo se concordate per iscritto dalle parti e limitatamente alle vendite cui si riferiscono.

PRODOTTI

I pesi, le dimensioni, i prezzi, i colori e gli altri dati figuranti nei cataloghi, prospetti, circolari, od altri documenti illustrativi della Società, hanno carattere di indicazioni approssimative.

Beta si riserva di variare in qualsiasi momento, senza preavviso, i dati tecnici o costruttivi dei suoi prodotti.

ORDINI

Le presenti Condizioni Generali di Vendita si intendono approvate dall'acquirente con la trasmissione dell'ordine, ordine che viene ricevuto dalla Società sempre con la clausola "salvo approvazione della casa". Beta può accettare l'ordine mediante spedizione della merce, conformemente all'art. 1327 c.c..

Nell'ordine deve essere specificato il codice dell'articolo e la relative quantità. Le quantità minime sono indicate nel listino per ciascun articolo. Ordini non corrispondenti ad esse, od ai loro multipli, verranno automaticamente adeguati senza previa autorizzazione al Cliente.

RIMANENZE

La Società si riserva la facoltà di evadere l'ordine tutto o in parte ovvero in diverse riprese. Nell'eventualità di ordini non completamente evasi Beta invierà tramite e-mail una distinta riepilogativa delle rimanenze di detti ordini che, salvo espressa richiesta contraria, saranno incluse nella o nelle spedizioni successive. Previa specifica richiesta del Cliente tali informazioni verranno trasmesse via fax.

TERMINI DI CONSEGNA

Eventuali termini di consegna, comunque e dovunque previsti, avranno valore puramente indicativo. La Società declina ogni responsabilità per il caso di ritardo nella consegna che non derivi da suo dolo o colpa grave. Il mancato rispetto dei termini di consegna, purché contenuto in un ragionevole lasso di tempo, non dà diritto al Cliente di richiedere un risarcimento, né di annullare gli Ordini, a meno che, avuto riguardo alla normale tollerabilità ed alla natura del contratto ed alla fornitura, la stessa non abbia più importanza per il Cliente. In questo caso l'onere probatorio sarà a carico del Cliente stesso.

Salvo il caso di dolo o colpa grave della Società, è espressamente escluso qualsiasi risarcimento del danno per mancata o ritardata consegna dei prodotti.

GESTIONE ORDINI, SPEDIZIONI E IMBALLI

Le spedizioni sono effettuate franco destino, con mezzi di trasporto a scelta della Società per gli ordini netti superiori ad € 600,00.

Per gli ordini inferiori ad € 600,00 verrà addebitato a titolo di contributo spese di trasporto il seguente importo:

contributo fisso di € 10,00 fino ad € 199,99

contributo pari al 3,50% da € 200,00 ad € 599,99.

L'imballo è gratuito quando non richiesto di tipo particolare.

Il trasferimento dei rischi relativi ai prodotti ha luogo al momento della loro consegna al Vettore: conseguentemente, i prodotti viaggiano a rischio e pericolo del destinatario anche in caso di spedizione porto franco.

L'Acquirente che sia già cliente abituale potrà utilizzare il **nostro servizio rapido** anche per quantità diverse dall'unità di confezionamento previste. Il costo del servizio verrà addebitato nella misura forfetaria del 6% in sede di fatturazione e le spese di spedizione saranno a carico del Cliente.

PREZZI

L'indicazione di prezzo contenuta in cataloghi, listini, ecc. è meramente indicativa e potrà quindi subire variazioni senza necessità di preventiva informazione. Salvo diverso accordo tra le parti, la merce sarà fatturata ai prezzi in vigore al momento della spedizione.

I prezzi si intendono al netto di iva, di eventuali imposte o tasse, nonché di tributi, diritti ed oneri fiscali o di qualsiasi specie eventualmente gravanti sul contratto che restano a carico esclusivo del Cliente.

PAGAMENTI

Il pagamento deve essere corrisposto direttamente presso la sede della Società in Via Volta n. 18 - 20845 SOVICO (MB) ovvero alla persona munita di autorizzazione scritta con le modalità e nei termini indicati nella fattura.

Sconti per pagamenti a breve termine vanno calcolati sull'importo netto della merce, escluso imballo, spese postali o di trasporto e iva. Trascorsi 15 giorni dalla data della fattura o dal periodo concordato, si intende revocato il beneficio dello sconto condizionato e pertanto la rimessa andrà effettuata per il totale della fattura. Il ritardato pagamento rispetto alla data pattuita darà luogo all'addebito degli interessi di mora di cui all'art. 5 del D.Lgs. 231/02 e produrrà la perdita per il Cliente del beneficio del termine ai sensi dell'art. 1186 cod. civ., rendendo immediatamente esigibili eventuali somme non ancora scadute.

Il Cliente non è autorizzato ad effettuare alcuna deduzione dal prezzo pattuito (ad es. in caso di pretesi difetti dei prodotti), se non previo accordo scritto con la Società.

GARANZIA

I prodotti venduti da Beta sono garantiti in relazione a vizi o difetti di fabbricazione; la garanzia è limitata alla sostituzione o riparazione dei prodotti riconosciuti difettosi presso la sede della Società, con esclusione di qualsiasi diritto al risarcimento dei danni. La suddetta garanzia non si applica a prodotti che presentano normale usura, segni di manomissione o di uso improprio. Le spese di trasporto dei prodotti da sostituire o riparare e dei prodotti sostituiti o riparati sono a carico dell'Acquirente. In presenza dei presupposti di cui al comma precedente Beta sostituirà o riparerà gratuitamente il Prodotto riscontrato difettoso all'origine se reso franco sede della Società con relativo documento di trasporto sul quale dovranno essere indicati, oltre alla dicitura merce difettosa, gli estremi della fattura emessa all'atto della vendita. Salvo il caso di dolo o colpa grave, la Società sarà tenuta, in caso di vizi o mancanza di qualità dei prodotti, unicamente alla riparazione o sostituzione dei prodotti difettosi. È inteso che la suddetta garanzia (consistente nell'obbligo di riparare o sostituire i prodotti) comprende e sostituisce ogni garanzia o responsabilità della Società (sia contrattuale che extracontrattuale) comunque originata dai prodotti forniti (ad es. risarcimento del danno, mancato guadagno ecc.).

RECLAMI

Il Cliente deve denunciare gli eventuali vizi e difetti dei prodotti forniti o l'eventuale mancata o difforme fornitura di tutto o parte dell'Ordine d'Acquisto, a pena di decadenza, entro il termine di 8 (otto) giorni da calcolarsi rispettivamente dalla data di consegna dei prodotti (vizi apparenti) e/o da quella della scoperta dei vizi o difetti (vizi occulti). Nel caso di vizi palesi la denuncia dovrà essere fatta per iscritto a mezzo di lettera raccomandata a.r..

Eventuali contestazioni non danno diritto al Cliente di sospendere o comunque ritardare i pagamenti dei prodotti oggetto di contestazione né, tanto meno, di altre forniture.

La garanzia non opera nel caso in cui l'Acquirente abbia eseguito o fatto eseguire interventi da parte di terzi sui prodotti, senza il preventivo consenso scritto di Beta. La merce difettosa, qualora non presenti inconvenienti dovuti a normale logorio, errato uso o evidente manomissione, verrà riparata o sostituita gratuitamente solo se restituita in porto franco presso la sede della Società, indicando nel documento di accompagnamento la causale e gli estremi della fattura relativa.

RESI

Eventuali resi di merce vengono accettati solo se preventivamente concordati e autorizzati per iscritto; contrariamente saranno rispediti al mittente con trasporto a proprio carico.

In ogni caso nel documento di accompagnamento devono essere indicati la causale del reso ed il numero di autorizzazione ricevuto.

Tali resi dovranno essere inviati presso la sede della Società in Via Volta n. 18 - 20845 SOVICO (MB).

FORO COMPETENTE

Le presenti Condizioni Generali di Vendita sono regolate dalle leggi della Repubblica Italiana. Per tutto quanto non espressamente regolato dalle presenti condizioni, sarà applicata la normativa del codice civile.

Per qualsiasi controversia derivante dal contratto di vendita disciplinati dalle presenti Condizioni Generali di Vendita o ad esso collegata sarà esclusivamente competente il Foro di Monza, fatte comunque salve diverse inderogabili norme di legge.

CONDIZIONI GENERALI DI VENDITA

Gli ordini trasmessi per l'acquisto di prodotti Robur dalla Beta Utensili SpA (d'ora in poi "Beta" o "Società") devono essere inviati alla nostra sede produttiva di Sulmona e comportano l'accettazione automatica e senza riserve delle presenti Condizioni Generali di Vendita che costituiscono parte integrante del contratto di vendita. Eventuali deroghe alle stesse saranno efficaci solo se concordate per iscritto dalle parti e limitatamente alle vendite cui si riferiscono.

PRODOTTI

I pesi, le dimensioni, i prezzi, i colori e gli altri dati figuranti nei cataloghi, prospetti, circolari, od altri documenti illustrativi della Società, hanno carattere di indicazioni approssimative.

Beta si riserva di variare in qualsiasi momento, senza preavviso, i dati tecnici o costruttivi dei suoi prodotti.

ORDINI

Le presenti Condizioni Generali di Vendita si intendono approvate dall'acquirente con la trasmissione dell'ordine, ordine che viene ricevuto dalla Società sempre con la clausola "salvo approvazione della casa". Beta può accettare l'ordine mediante spedizione della merce, conformemente all'art. 1327 c.c..

Nell'ordine deve essere specificato il codice dell'articolo e la relativa quantità.

Le quantità minime sono indicate nel listino per ciascun articolo. Ordini non corrispondenti ad esse, od ai loro multipli, verranno automaticamente adeguati senza previa autorizzazione al Cliente.

RIMANENZE

La Società si riserva la facoltà di evadere l'ordine tutto o in parte ovvero in diverse riprese. Nell'eventualità di ordini non completamente evasi Beta invierà tramite e-mail una distinta riepilogativa delle rimanenze di detti ordini che, salvo espressa richiesta contraria, saranno incluse nella o nelle spedizioni successive. Previa specifica richiesta del Cliente tali informazioni verranno trasmesse via fax.

TERMINI DI CONSEGNA

Eventuali termini di consegna, comunque e dovunque previsti, avranno valore puramente indicativo. La Società declina ogni responsabilità per il caso di ritardo nella consegna che non derivi da suo dolo o colpa grave. Il mancato rispetto dei termini di consegna, purché contenuto in un ragionevole lasso di tempo, non dà diritto al Cliente di richiedere un risarcimento, né di annullare gli Ordini, a meno che, avuto riguardo alla normale tollerabilità ed alla natura del contratto ed alla fornitura, la stessa non abbia più importanza per il Cliente. In questo caso l'onere probatorio sarà a carico del Cliente stesso.

Salvo il caso di dolo o colpa grave della Società, è espressamente escluso qualsiasi risarcimento del danno per mancata o ritardata consegna dei prodotti.

GESTIONE ORDINI, SPEDIZIONI E IMBALLI

Le spedizioni sono effettuate franco destino con addebito delle spese in fattura con mezzi di trasporto a scelta della Società.

L'imballo è gratuito quando non richiesto di tipo particolare.

Il trasferimento dei rischi relativi ai prodotti ha luogo al momento della loro consegna al Vettore: conseguentemente, i prodotti viaggiano a rischio e pericolo del destinatario anche in caso di spedizione porto franco.

L'Acquirente che sia già cliente abituale potrà utilizzare il **nostro servizio rapido** anche per quantità diverse dall'unità di confezionamento previste. Il costo del servizio verrà addebitato nella misura forfetaria del 6% in sede di fatturazione e le spese di spedizione saranno a carico del Cliente.

PREZZI

L'indicazione di prezzo contenuta in cataloghi, listini, ecc. è meramente indicativa e potrà quindi subire variazioni senza necessità di preventiva informazione. Salvo diverso accordo tra le parti, la merce sarà fatturata ai prezzi in vigore al momento della spedizione.

I prezzi si intendono al netto di iva, di eventuali imposte o tasse, nonché di tributi, diritti ed oneri fiscali o di qualsiasi specie eventualmente gravanti sul contratto che restano a carico esclusivo del Cliente.

PAGAMENTI

Il pagamento deve essere corrisposto direttamente presso la sede della Società in Via Volta n. 18, 20845 Sovico (MB) ovvero alla persona munita di

autorizzazione scritta con le modalità e nei termini indicati nella fattura.

Sconti per pagamenti a breve termine vanno calcolati sull'importo netto della merce, escluso imballo, spese postali o di trasporto e iva. Trascorsi 15 giorni dalla data della fattura o dal periodo concordato, si intende revocato il beneficio dello sconto condizionato e pertanto la rimessa andrà effettuata per il totale della fattura.

Il ritardato pagamento rispetto alla data pattuita darà luogo all'addebito degli interessi di mora di cui all'art. 5 del D.Lgs. 231/02 e produrrà la perdita per il Cliente del beneficio del termine ai sensi dell'art. 1186 cod. civ., rendendo immediatamente esigibili eventuali somme non ancora scadute.

Il Cliente non è autorizzato ad effettuare alcuna deduzione dal prezzo pattuito (ad es. in caso di pretesi difetti dei prodotti), se non previo accordo scritto con la Società.

GARANZIA

I prodotti venduti da Beta sono garantiti in relazione a vizi o difetti di fabbricazione; la garanzia è limitata alla sostituzione o riparazione dei prodotti riconosciuti difettosi presso la sede della Società, con esclusione di qualsiasi diritto al risarcimento dei danni. La suddetta garanzia non si applica a prodotti che presentano normale usura, segni di manomissione o di uso improprio. Le spese di trasporto dei prodotti da sostituire o riparare e dei prodotti sostituiti o riparati sono a carico dell'Acquirente. In presenza dei presupposti di cui al comma precedente Beta sostituirà o riparerà gratuitamente il Prodotto riscontrato difettoso all'origine se reso franco sede della Società con relativo documento di trasporto sul quale dovranno essere indicati, oltre alla dicitura merce difettosa, gli estremi della fattura emessa all'atto della vendita.

Salvo il caso di dolo o colpa grave, la Società sarà tenuta, in caso di vizi o mancanza di qualità dei prodotti, unicamente alla riparazione o sostituzione dei prodotti difettosi. È inteso che la suddetta garanzia (consistente nell'obbligo di riparare o sostituire i prodotti) comprende e sostituisce ogni garanzia o responsabilità della Società (sia contrattuale che extracontrattuale) comunque originata dai prodotti forniti (ad es. risarcimento del danno, mancato guadagno ecc.).

RECLAMI

Il Cliente deve denunciare gli eventuali vizi e difetti dei prodotti forniti o l'eventuale mancata o difforme fornitura di tutto o parte dell'Ordine d'Acquisto, a pena di decadenza, entro il termine di 8 (otto) giorni da calcolarsi rispettivamente dalla data di consegna dei prodotti (vizi apparenti) e/o da quella della scoperta dei vizi o difetti (vizi occulti). Nel caso di vizi palesi la denuncia dovrà essere fatta per iscritto a mezzo di lettera raccomandata a.r..

Eventuali contestazioni non danno diritto al Cliente di sospendere o comunque ritardare i pagamenti dei prodotti oggetto di contestazione né, tanto meno, di altre forniture.

La garanzia non opera nel caso in cui l'Acquirente abbia eseguito o fatto eseguire interventi da parte di terzi sui prodotti, senza il preventivo consenso scritto di Beta. La merce difettosa, qualora non presenti inconvenienti dovuti a normale logorio, errato uso o evidente manomissione, verrà riparata o sostituita gratuitamente solo se restituita in porto franco presso la sede della Società, indicando nel documento di accompagnamento la causale e gli estremi della fattura relativa.

RESI

Eventuali resi di merce vengono accettati solo se preventivamente concordati e autorizzati per iscritto; contrariamente saranno rispediti al mittente con trasporto a proprio carico.

In ogni caso nel documento di accompagnamento devono essere indicati la causale del reso ed il numero di autorizzazione ricevuto.

Tali resi dovranno essere inviati presso la sede produttiva della Società in Zona Industriale - Contrada S. Nicola - 67039 SULMONA (AQ).

FORO COMPETENTE

Le presenti Condizioni Generali di Vendita sono regolate dalle leggi della Repubblica Italiana. Per tutto quanto non espressamente regolato dalle presenti condizioni, sarà applicata la normativa del codice civile.

Per qualsiasi controversia derivante dal contratto di vendita disciplinati dalle presenti Condizioni Generali di Vendita o ad esso collegata sarà esclusivamente competente il Foro di Monza, fatte comunque salve diverse inderogabili norme di legge.

ORGANIZZAZIONE DI VENDITA

 **Beta**

 **Robur**

VALLE D'AOSTA

PIEMONTE: Torino, Vercelli, Biella
MARCO MARTORANA
Cell. 392.4135190
mezzarana@libero.it
marco.martorana1969@gmail.com

LIGURIA

PIEMONTE: Alessandria, Asti, Cuneo
ALESSANDRO DE SANCTIS
Cell. 348.3008699
Fax 019.90085
info@alessanc.it

PIEMONTE: Novara, Verbano-Cusio-Ossola

LOMBARDIA: Varese
LORENZO MASOLINI
Cell. 347.7770745
lorenzo.masolini@gmail.com

LOMBARDIA: provincia Nord Milano, Monza Brianza, Como, Sondrio

ANDREA BRAMBILLA
Cell. 335.8359534
andrea.brambilla@libero.it

LOMBARDIA: Pavia, Milano città, provincia Sud Milano

LUIGI FUMAGALLI SAS
Cell. 335.214487
lfrappresentanze@tiscalinet.it

LOMBARDIA: Bergamo, Lecco

AVIDANO SIMEONI
Cell. 335.5296941
ufficio@avidanosimeoni.it

LOMBARDIA: Mantova

VENETO: Verona
PIERLUCA VARLIERO
Cell. 328.2290866
pierluccavarliero@libero.it

LOMBARDIA: Cremona, Lodi, Milano Est

STEFANO MESSAGGI
Cell. 347.9672424
stefano.messaggi@yahoo.it

LOMBARDIA: Brescia

LOWRENCE ZANARDINI
Cell. 346.8096241
lowrence.zanardini@gmail.com

TRENTINO ALTO ADIGE

VENETO: Vicenza
TARGA SERGIO & C. SAS
Cell. 348.4112065
targa_s70@yahoo.it

VENETO: Padova, Rovigo, Belluno, Treviso, Venezia

NICOLA MION
Cell. 335.8427204
Fax 0422.452468
info@nicolamionagenzia.com

FRIULI VENEZIA GIULIA

GIANLUCA PODRECCA
Cell. 335.8140638
gianluca.podrecca@gmail.com

EMILIA ROMAGNA: Modena, Parma, Reggio Emilia, Piacenza

MARCO PERVILLI
Cell. 335.7013227
m.pervilli@gmail.com

EMILIA ROMAGNA: Bologna, Ferrara, Ravenna

TOMMASO LIGORIO
Cell. 327.1191445
tommaso.ligorio16@gmail.com

EMILIA ROMAGNA: Forlì-Cesena, Rimini

REP. SAN MARINO
BRT RAPPRESENTANZE DI RITA BERTOLAZZI
Cell. 380.2345860
brtrappresentanze@gmail.com

TOSCANA: Firenze, Livorno, Lucca, Massa Carrara, Pisa, Pistoia, Prato

STEFANO CAMERINI
Cell. 347.5084765
Fax 055.289350
camerini.stefano@tiscali.it

TOSCANA: Arezzo, Grosseto, Siena

UMBRIA
MASSIMO CATORCI
Cell. 335.6899323
massimo.catorci@gmail.com

MARCHE

ALEX CAPPANERA
Cell. 339.4718269
alex@cappanera.it

ABRUZZO - MOLISE

MARIO BALLISTRERI
Cell.: 349.2550232
ballistrerirappresentanze@gmail.com

LAZIO

DANIELE MARINELLI
Tel. 06.8177774
Cell. 335.5394617
Fax 06.39725066
marinelliagenzia@tiscali.it

CAMPANIA: Benevento, Caserta, Napoli Nord

ANTONINO SCOGNAMIGLIO
Cell. 335.5281534
Fax 081.2140299
antonino.scognamiglio@fastwebnet.it

CAMPANIA: Avellino, Salerno, Napoli Sud

ESPOSITO RAPPRESENTANZE
Cell. 335.6212740
Fax 081.2140299
alfredo-esposito@fastwebnet.it

PUGLIA

NICOLA MORISCO
Cell. 335.5489086
Tel. 080/5016492
info@moriscorappresentanze.it

BASILICATA

VINCENZO GALLITELLI
Cell. 335.1436354
vincenzo.gallitelli@libero.it

CALABRIA

DOMENICO ARAGONA
Cell. 337.872220 (Domenico)
Cell. 339.8740220 (Francesco)
Fax 0984.465320
aragonarappresentanze@gmail.com

SICILIA EST: Messina, Catania, Siracusa, Ragusa, Enna

ANTONIO BOTTARI
Cell.: 349.7965120
antonio.bottari@outlook.it

SICILIA OVEST: Palermo, Trapani, Caltanissetta, Agrigento

DANIELE MARGIOTTA
Cell. 334.8016524
danielemargiotta@tiscali.it

SARDEGNA: Oristano, Cagliari, Carbonia-Iglesias, Medio Campidano

PI.CO - LUCIANO COMPARETTI
Cell. 349.4977448
Fax 070.513150
pico.comparetti@gmail.com

SARDEGNA: Sassari, Nuoro, Ogliastra, Olbia-Tempio

PI.CO - SALVATORE PILLA
Cell. 349.4977449
Fax 079.501493
pico.pilla@gmail.com



IL NOSTRO **SERVIZIO RAPIDO**

1. Possibilità di acquistare qualsiasi articolo a listino senza obbligo di quantità
2. Consegna in tutta Italia nelle 24 ore per ordini pervenuti entro le ore 11.00 (48 ore per Basilicata, Calabria, Sardegna, Sicilia)
 - A. Gli ordini devono essere inviati unicamente tramite fax al numero 800.978.377 o via e-mail a: servizio.rapido@beta-tools.it
 - B. Il costo del servizio verrà addebitato nella misura forfettaria del 6% in sede di fatturazione
 - C. Le spese di spedizione sono a carico del cliente



È possibile effettuare il ritiro della merce con mezzi propri ai seguenti indirizzi:

- 📍 Magazzino sede Beta - via Volta 18, 20845 Sovico (MB)
- 📍 Polo logistico TIESSE S.p.a. - Via Arno 8
20098 San Giuliano Milanese (Mi)
- 📍 GEODIS CL ITALIA S.p.a - SP23 località Cascina Postino
26815 Massalengo (LO)

NUMERI CHIAVE GRUPPO BETA



Visita www.gruppo-beta.com



10 Unità
produttive
IN ITALIA



Oltre **1.000**
collaboratori

11 Filiali
nel mondo

Presenti in più
di **100 Paesi**
nel mondo
con oltre **250**
importatori



BETA UTENSILI S.p.A. - 20845 Sovico (MB)
Via A.Volta, 18 - Tel. 039.2077.1 - Fax 039.2010742
www.beta-tools.com

Sede produttiva Accessori per funi Robur:
67039 Sulmona (AQ) Zona Industriale - C.da S. Nicola
Tel. 0864.2504.1 - Fax 0864.253132
www.roburity.com - info@roburity.com

LA STORIA DELL' UTENSILERIA ITALIANA

- 1923** ● Alessandro Ciceri fonda ad Erba (CO) la stamperia "Alessandro Ciceri & Figli", specializzata in stampi di ferro e acciaio.
- 1939** ● Viene depositato il marchio Beta e l'Azienda si specializza nella **produzione di utensili per uso professionale**, realizzati nello stabilimento di Sovico (MB), ancora attuale sede aziendale.
- 1960** ● Beta Utensili conta già 200 dipendenti, si afferma in Italia quale realtà emergente nel settore dell'utensileria a mano professionale ed esporta i propri prodotti all'estero.
- 1969** ● Nasce il rivoluzionario **carrello "Tank"** in lamiera arancione, il colore che, da quel momento in poi, renderà inconfondibile lo stile del marchio Beta.
- 1971** ● Beta Utensili entra nel mondo delle **competizioni motoristiche**, dapprima in Formula 1, poi nelle gare di rally e nel mondo del Motorsport.
- 1973** ● Si inaugura lo **stabilimento di Castiglione d'Adda (LO)**, che si aggiunge a quello storico di Sovico (MB).
- 1975** ● Arriva il primo grande successo in Formula 1 con la **March-Beta Utensili** di colore arancione di Vittorio Brambilla che vince il Gran Premio d'Austria nel diluvio di Zeltweg.
- 1980** ● Continua l'espansione nei più importanti mercati Europei con la **costituzione progressiva di filiali Beta Utensili** in Francia, Gran Bretagna, Olanda, Spagna, Polonia e Ungheria.
- 1984** ● Apre il **terzo stabilimento** dell'azienda a **Sulmona (AQ)**. Qui ha inizio, nella forgia, la produzione delle iconiche chiavi combinate 42 e vengono prodotti e testati gli accessori per il sollevamento a marchio Robur.
- 2000** ● La presentazione del nuovo catalogo Beta Utensili conferma il **continuo processo di crescita**. Raddoppia la gamma dei prodotti in offerta e le oltre 10.000 referenze vengono suddivise in 22 famiglie di prodotto.
- 2002** ● L'offerta Beta Utensili viene ulteriormente ampliata con l'introduzione della gamma di **abbigliamento e calzature da lavoro**.
- 2009** ● Inizia l'espansione oltreoceano con la costituzione della filiale Beta China e, tre anni dopo, di Beta do Brasil.
- 2016** ● Beta introduce il nuovo sistema modulare per l'arredo officina RSC55.
- 2018** ● Inizia il percorso di consolidamento del Gruppo Beta con l'acquisizione di **BM S.p.A.**, leader nella produzione di capicorda e sistemi di connessione elettrica. Si susseguono le acquisizioni di **3D Beta S.r.l.**, specializzata nella progettazione e produzione di sistemi di arredo officina su misura e **VGF S.r.l.**, specialista nella verniciatura a polveri di arredi in metallo.
- 2019** ● Prosegue il percorso di consolidamento del Gruppo Beta con le acquisizioni di **Abra Beta S.p.A.** ed **Elpa Abrasivi S.r.l.**, aziende leader nella produzione di abrasivi.
- 2020** ● Nasce **Beta Tools USA**, un passo importante nella strategia di espansione sul mercato nordamericano.
- 2023** ● Si consolida il Gruppo con l'ingresso di **Helvi S.p.A.**, uno dei principali player negli articoli per la saldatura dei metalli. Il Gruppo Beta supera così i **1.000 collaboratori** nel mondo, includendo **40 famiglie di prodotto** e **oltre 30.000 referenze**, realizzate per rispondere alle esigenze dei professionisti e garantire qualità e prestazioni costanti nel tempo, seguendo il principio **Beta Well Done**, perché in Beta esiste un solo modo di fare le cose: farle bene.



1923 Alessandro Ciceri & Figli



1939 Reparto forgia



1955 Reparto tranciatura

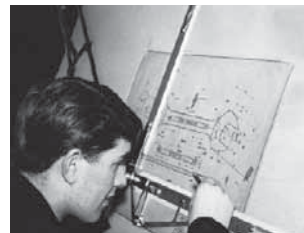

1960 Progettazione



1969 Carrello Tank



1974 Pubblicità assortimenti



1975 Vittorio Brambilla



2002 Abbigliamento e calzature da lavoro



2016 Arredo officina RSC55

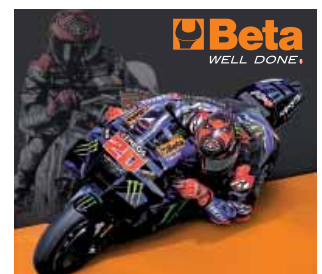

2023 Fabio Quartararo, Beta Ambassador

QUALITÀ CERTIFICATA

Beta, già nel 1995, ottiene la certificazione **Sistema di Qualità ISO 9001**, mentre dal 2018 si fregia del prestigioso marchio **TÜV**, ottenuto superando gli stretti controlli del protocollo di prova EK5/TA5.

Il protocollo EK5/TA5 prevede 31 caratteristiche costruttive ben definite, stringenti test statici e test di comportamento dinamico. Altri test definiscono la resistenza alle alte e basse temperature, la durata delle marcature nel tempo e la resistenza alla corrosione.

Il raggiungimento di questi traguardi premia la progettazione esperta, la realizzazione accurata e i controlli stringenti che Beta attua nella produzione di cassettiere e che ne hanno garantito fino ad oggi il grande successo.



CONTROLLO E QUALITÀ

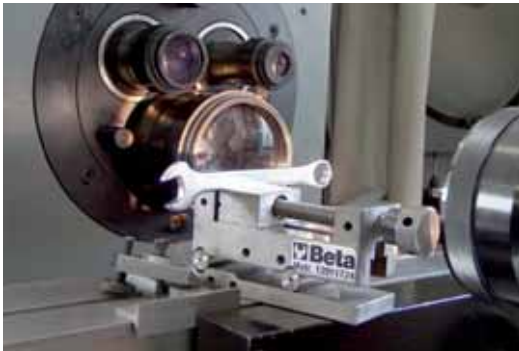

Per Beta la qualità ha un significato semplice e concreto: ciò che soddisfa in modo completo le esigenze e le aspettative dei professionisti che fanno del nostro prodotto uno strumento fondamentale per il loro lavoro.

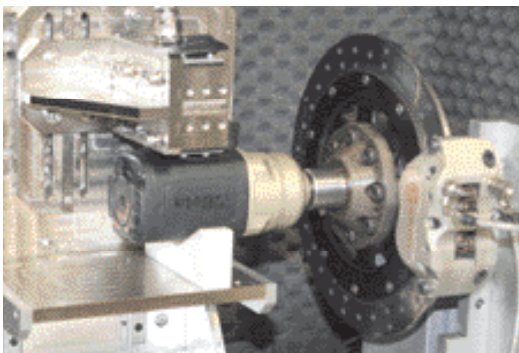

L'utensile non è solo studiato e realizzato correttamente per adempiere alla sua funzione, ma garantisce la ripetitività delle prestazioni in modo omogeneo nel tempo.

La qualità in Beta non si esprime solo con un'attenta politica industriale e commerciale, ma permea ogni divisione aziendale con il medesimo orientamento al raggiungimento di obiettivi sempre più ambiziosi in termini di soddisfazione della clientela.

È su questo concetto che Beta ha costruito la sua storia.

**Qualità Beta,
l'aspetto più
concreto**



**La qualità degli
utensili Beta
è la sintesi
di tecniche antiche
e nuove tecnologie.**



Dal 1995 i processi produttivi sono certificati conformi agli standard del Sistema di Qualità ISO 9001



PROFESSIONALITÀ E COMPETENZA AL SERVIZIO DELL'INDUSTRIA



Gli utensili Beta sono da sempre protagonisti nella manutenzione industriale grazie alla storica e capillare presenza dei nostri partner distributori lungo tutta la penisola.

Grazie alla qualità ed alle alte prestazioni i prodotti Beta supportano ogni esigenza professionale e sono scelti quotidianamente da importanti industrie dell'automotive, dell'energia, dell'aeronautica, del navale e molti altri settori in Italia e nel mondo. Ma è il forte legame con i nostri distributori sul territorio che ci permette di servire tante delle piccole, medie e grandi industrie italiane, vero motore del nostro Paese.

Con l'obiettivo di migliorare ulteriormente il servizio di consulenza e portare innovazione e competenze nel fitto tessuto industriale italiano continuiamo ad investire con la squadra di **Sales Manager Industria**, professionisti a cui rivolgersi per:

- ▶ Identificazione di nuove opportunità di business
- ▶ Soluzioni operative presso le industrie
- ▶ Supporto tecnico - commerciale
- ▶ Ottimizzazione delle dotazioni di utensili nei reparti produttivi
- ▶ Personalizzazione delle isole di lavoro
- ▶ Aggiornamenti su tutte le novità di prodotto



La costante interazione con gli utilizzatori, sempre supportata dalla collaborazione con i nostri partner distributivi, è uno dei punti cardine del nostro miglioramento continuo nel comparto industriale.

Rivolgetevi al vostro agente Beta di zona per avere il contatto dei **Sales Manager Industria** a vostra disposizione per supportarvi nel servizio e contribuire ad accrescere il vostro business.



LOGISTICA



30.000 m²
di superficie



40.000
i codici gestiti
con oltre **27.000**
unità di carico



Consegne
veloci, accurate
e complete



ORGANIZZAZIONE DEL LAVORO

5S è una metodologia di organizzazione dell'area di lavoro di origine giapponese. Trae il nome dalla trascrizione occidentale di 5 parole giapponesi: **seiri, seiton, seiso, seiketsu e shitsuke**.

Seguendo i 5 passaggi identificati dalle parole si ottiene un metodo sistematico e ripetibile per l'ottimizzazione degli standard di lavoro e per il miglioramento delle performance operative.



SEIRI

Seleziona

Elimina il superfluo dallo spazio di lavoro e mantieni solo gli strumenti di cui hai bisogno.



SEITON

Sistematizza

Crea ordine: ogni cosa al suo posto e un posto per ogni cosa.



SEISO

Sistema

Pulisci il tuo spazio di lavoro e mantieni l'ordine nel tempo.



SEIKETSU

Standardizza

Stabilisci delle metodologie ripetitive per continuare a razionalizzare le risorse e gli spazi, definendo uno standard da seguire.



SHITSUKE

Supporta

Sostieni e diffondi questo modo di pensare e di agire in tutte le attività aziendali.



BENEFICI



Risparmio di tempo e riduzione dei costi



Miglioramento della qualità e della produttività



Riduzione degli infortuni sul lavoro



Incremento dell'efficienza



PRIMA



DOPO

PRESENZA COMPETENTE



I **Promotori Tecnici** guidano la flotta dei Van dimostrativi Beta fino ai luoghi di lavoro per ascoltare le esigenze di chi utilizza ogni giorno gli utensili in modo professionale. È uno scambio reciproco di informazioni, indicazioni, consigli e soluzioni, che arricchiscono la conoscenza di entrambe le parti.

I Van Beta sono allestiti con le ultime novità e con le attrezzature più complesse: l'utilizzatore può testare i prodotti, vedere come funzionano, e valutarne qualità e caratteristiche.



**Unità
dimostrativa**

Note

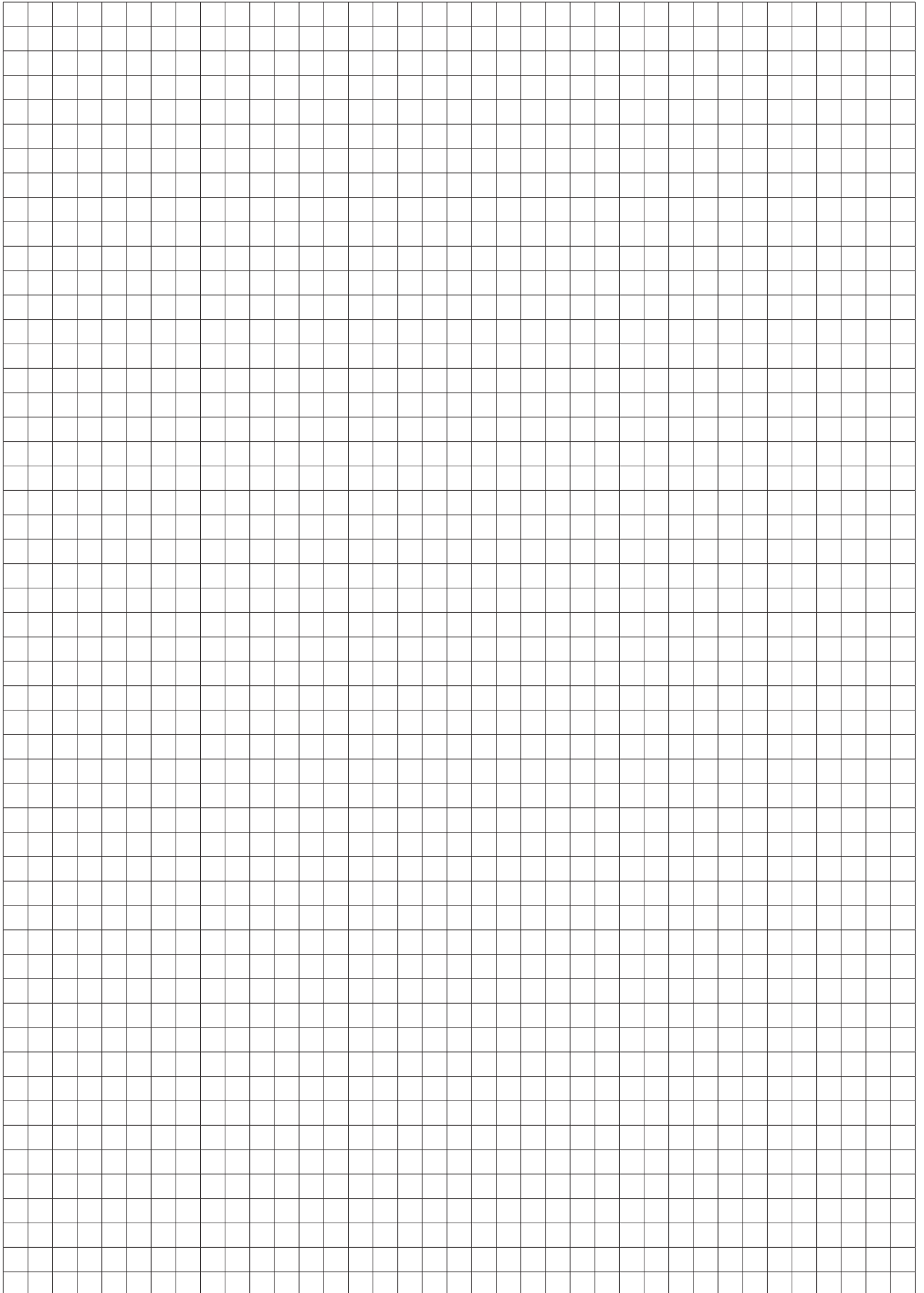

Note

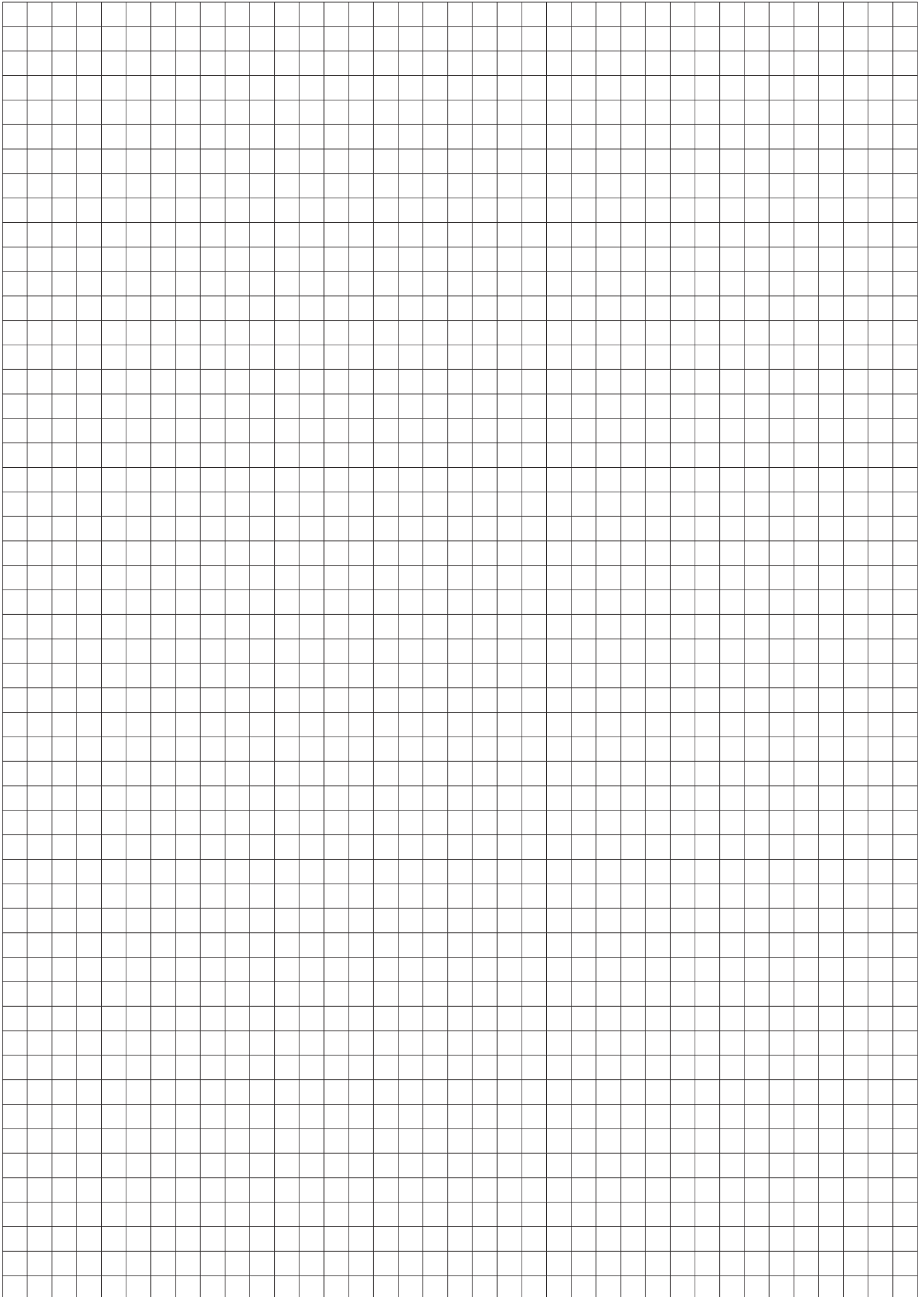

Note

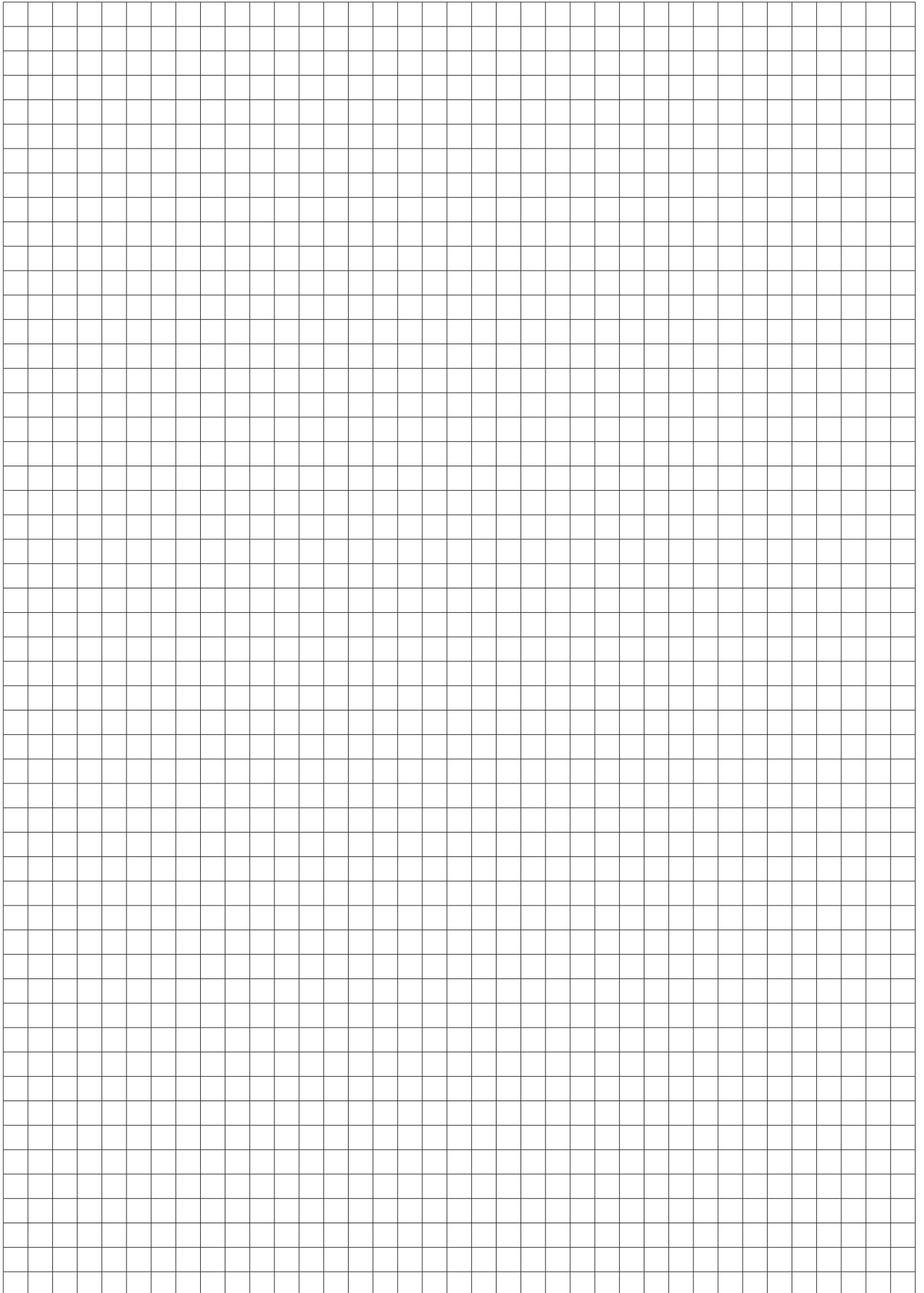

Note

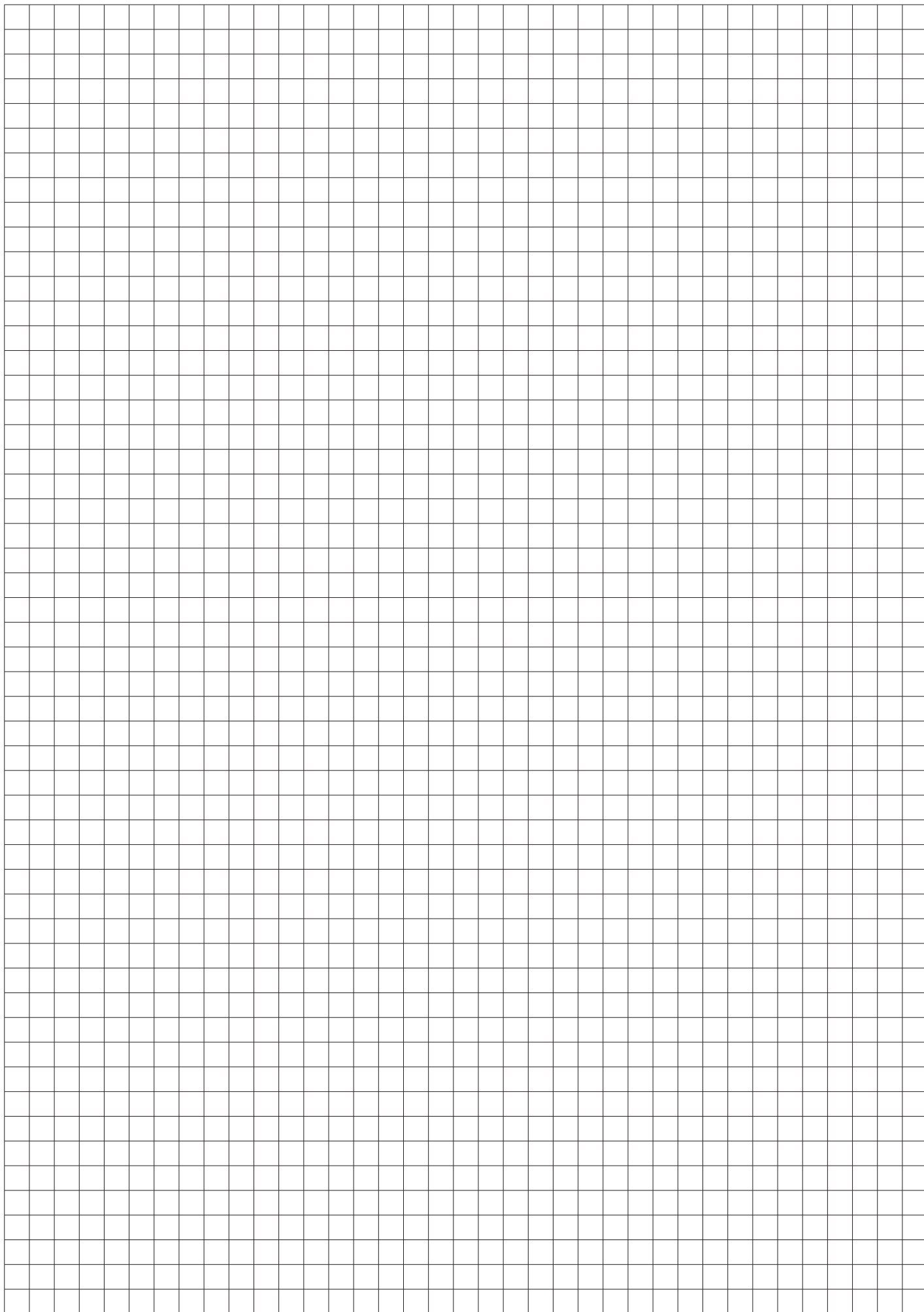

Note

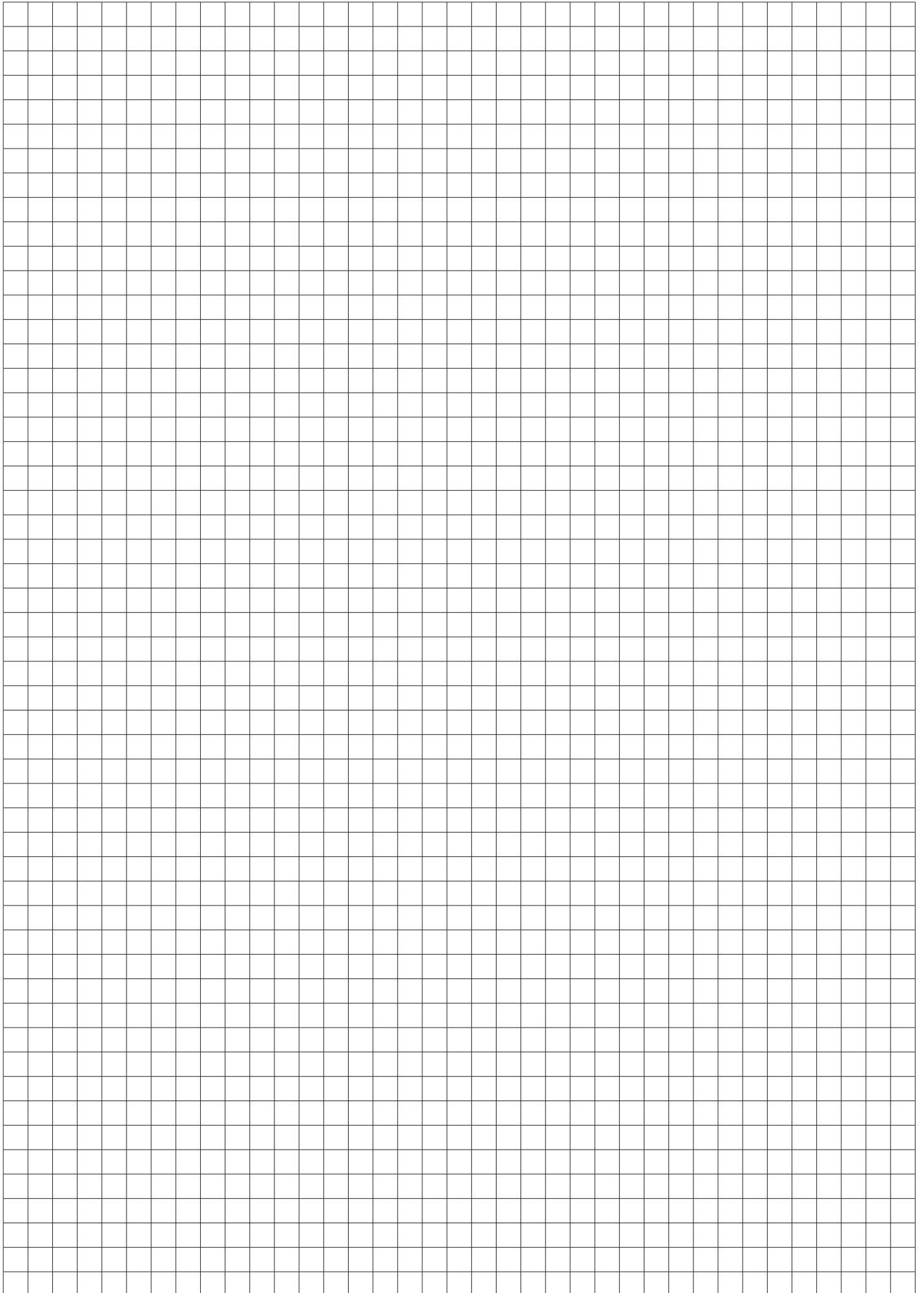

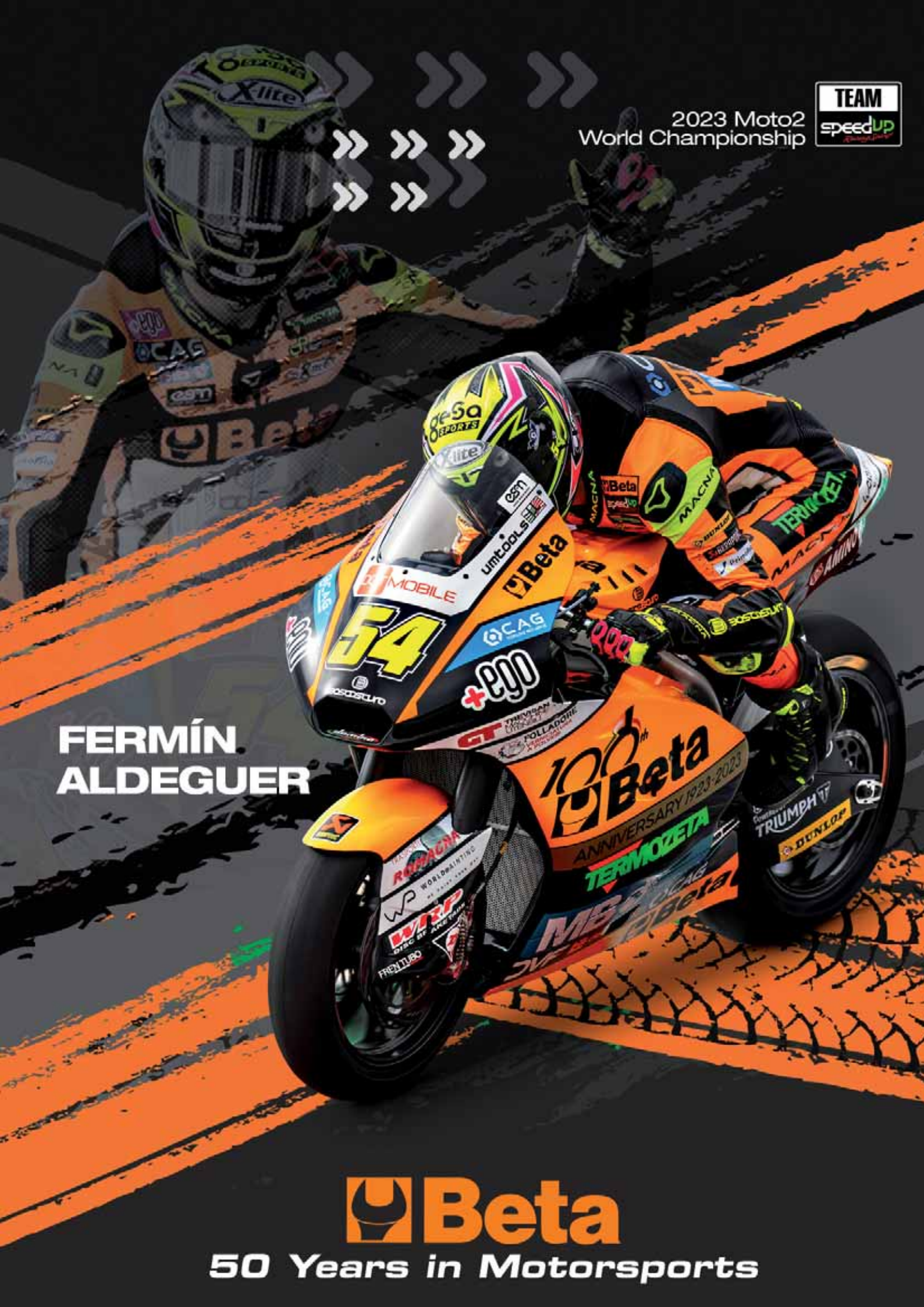

2023 Moto2
World Championship



**FERMÍN
ALDEGUER**

Beta
50 Years in Motorsports

2023

PARTNERSHIP



 **Beta**
AMBASSADOR

FABIO QUARTARARO
2023 MotoGP
World Championship



Technical
Partner



998069200



8 054809 548296

